

alba.

2025
CATALOGUE

ITA/ENG

2025
CATALOGUE



362

90



274

ala



260

aria



396

bases



417

bench components



90

clever



374

coat hangers



400

components



94

contract tables



282

duetto



348

eden



406

e:usb



152

feel

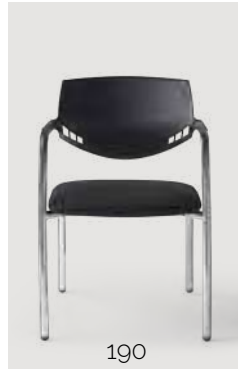

190

flash



388

**foot rings &
columns**



28

gemma



10

genesi



66

jota



42

lemon



214

logan

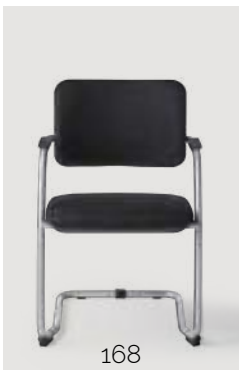

168

magix



290

manila

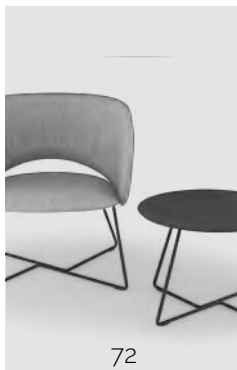

72

maui



82

meti



132

modula

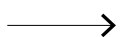

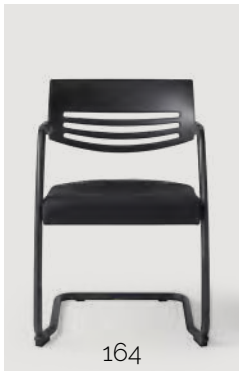

164
moon



266
nexus



328
oki



352
paco



228
pinko



298
pluto



314
pull



320
q5



196
q9



334
race



278
siton



392
slide bases



342
smile



116
spot



202
square



106

tapas



306

teddy



86

tipper



120

unyo



356

vicenza



142

wing



242

x3



56

xylo



180

young/key/fabric



out of catalogue

athos



out of catalogue

butterfly



out of catalogue

perù



out of catalogue

q9 4-legs



out of catalogue

stella base

disponibili con Quantità Minima d'Ordine
Minimum Order Quantity available

chi siamo

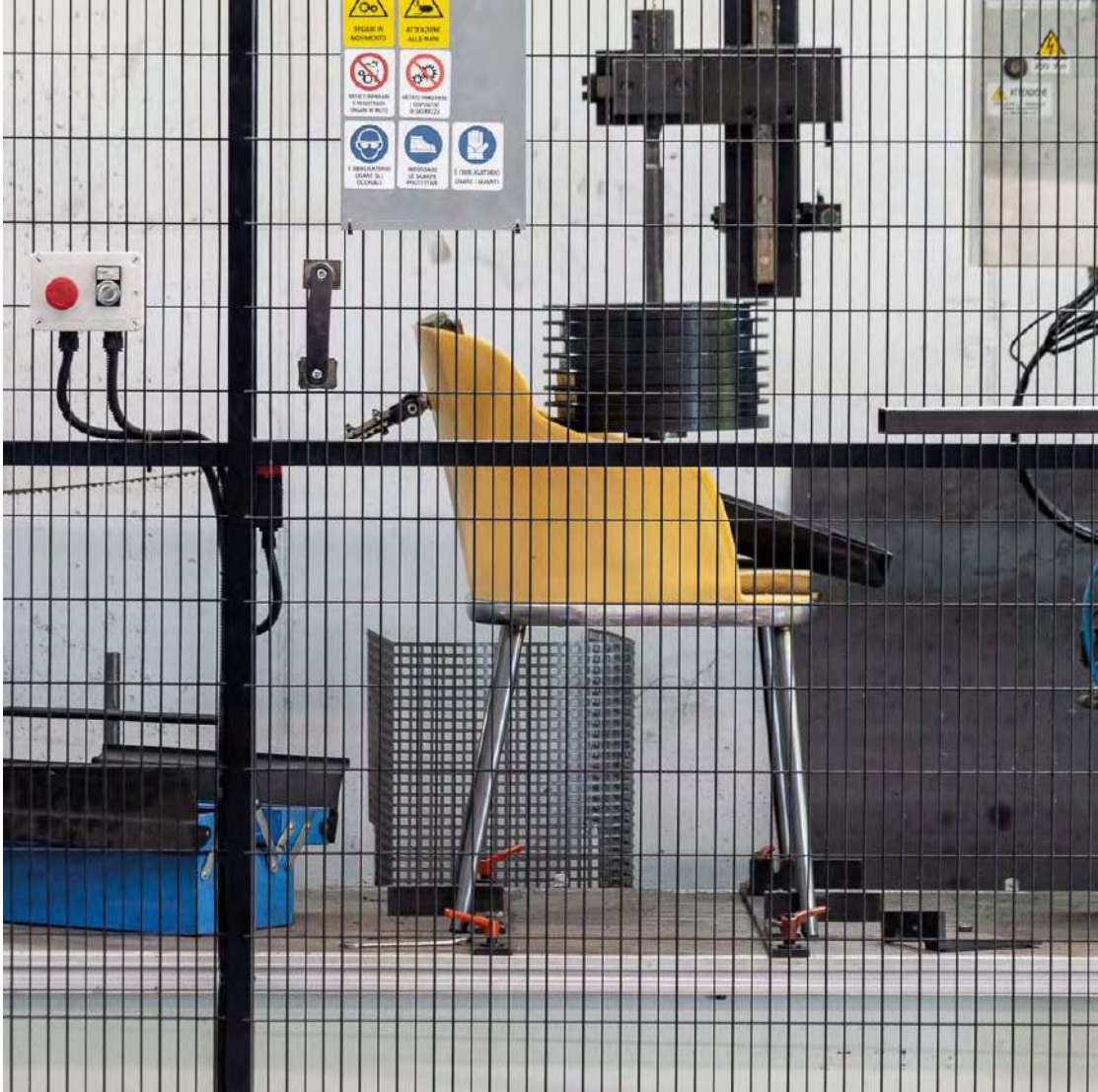

Alba, fondata nel 1981, è un'affermata azienda italiana nel settore della progettazione e produzione di soluzioni d'arredo versatili e di qualità. Con una vasta gamma di sedute, tavoli e altri elementi per l'arredo, Alba offre collezioni in grado di coniugare design innovativo, funzionalità, praticità e un bilanciato rapporto qualità-prezzo.

La nostra esperienza pluriennale ci permette di realizzare prodotti completi, venduti in kit pronti per l'assemblaggio. Dalla progettazione alla produzione, nei nostri stabilimenti in Italia, ci poniamo come un partner affidabile per aziende del settore arredo - dal mondo Community, all'Office, fino al Contract e Ho.Re.Ca.



Alba, founded in 1981, is an established Italian company in the design and production of versatile and quality furniture solutions. With a wide range of chairs, tables and other furniture elements, Alba offers collections that combine innovative design, functionality, practicality and a balanced quality-price ratio.

Our years of experience enable us to produce complete products, offered in ready-to-assemble kits. All the way from design to production, in our facilities in Italy, we stand as a reliable partner for companies in the furniture sector - from the Community and Office worlds to Contract and Ho.Re.Ca.

about us

alba.

catalogo | intro



Il catalogo generale Alba raccoglie la nostra vasta gamma di soluzioni d'arredo, tutte presentate con una intuitiva logica a kit di montaggio che facilita la comprensione, anche tecnica, dei prodotti.

Le collezioni Alba spaziano dalle sedie, ai tavoli e agli sgabelli, passando alle panche per l'attesa, divani, poltrone, scaffali e appendiabiti. Ogni prodotto coniuga in modo equilibrato design innovativo, funzionalità pratica e un rapporto qualità-prezzo bilanciato.



The Alba general catalog brings together our wide range of furniture solutions, all presented with an intuitive assembly kit logic that facilitates understanding, including the technical aspects, of the products.

Alba collections range from chairs, tables and stools to waiting benches, sofas, armchairs, shelves and coat racks. Each product combines innovative design, practical functionality, and balanced value for money in a balanced way.

catalog | intro



genesis



discover more about
Genesis Collection

Genesis è un versatile sistema di sedute orientato verso la flessibilità d'uso e la completezza.

Offre infatti numerose opzioni di combinazione tra telai, basi, schienali e sedili, e accessori, adattandosi così a diversi contesti di utilizzo come uffici, sale conferenze, ambienti didattici e spazi di co-working.

Genesis is a versatile seating system oriented towards flexibility of use and completeness.

In fact, it offers numerous combination options among frames, bases, backrests, seats, and accessories, thus adapting to various usage contexts such as offices, conference halls, educational environments, and co-working spaces.

Plus

- Assemblaggio facile e veloce ad incastro, nessuna vite.
- Innovativo e brevettato sistema di installazione del bracciolo.
- Certificazione EN 16139:2013 Livello 2. Certificazione ANSI/ BIFMA X5.1.
- Ampia scelta di colori, finiture e accessori.
- *Quick and easy interlocking assembly, no screws.*
- *Innovative and patented armrest installation system.*
- *EN 16139:2013 Level 2 certification. ANSI/BIFMA X5.1 Certification.*
- *Wide choice of colors, finishes and accessories.*



designed by:
Emanuele Bertolini



**trolley
available**



**certified
product**



**patented
product**

genesis

4-legs

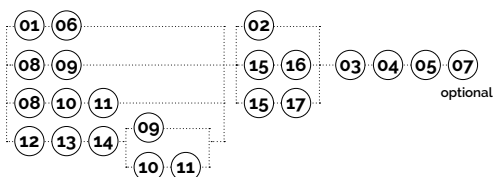
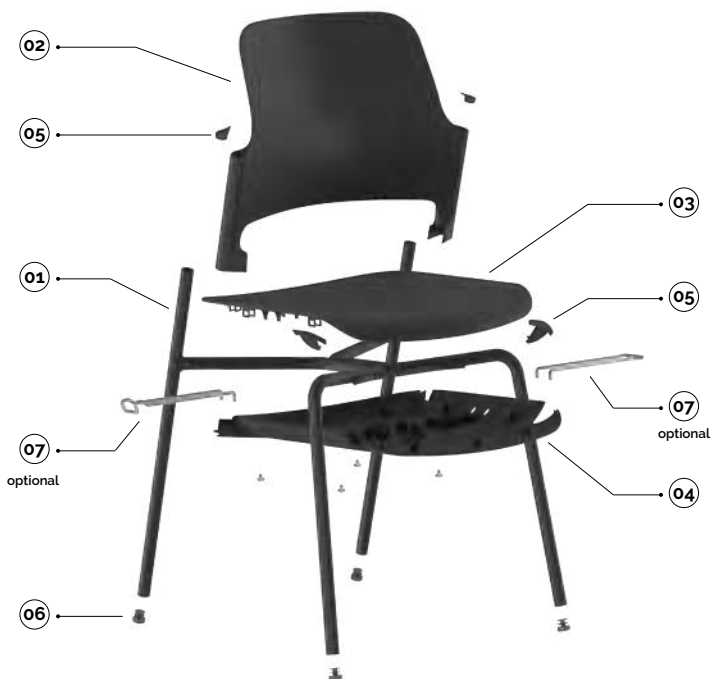
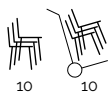

plastic colours

- nero/black
- bianco/white
- grigio/grey
- blu/blue

main component sizes

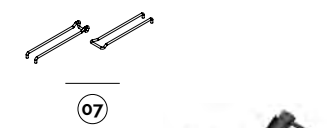
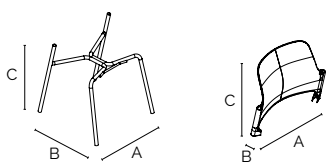

01 genesis - telaio 4 gambe ø.22 senza tappi genesis - 4 legs frame ø.22 without caps

code	finishing	q.kit	q.pack	a	b	c	kg.x1	vol.x1
110103-564	● nero/black	x1	72	545	555	605	3,92	mc. 0.08
110105-564	● bianco/white	x1	72	545	555	605	3,92	mc. 0.08
110104-564	● grigio/grey	x1	72	545	555	605	3,92	mc. 0.08
110110-564	● cromato/chrome	x1	72	545	555	605	3,92	mc. 0.08

02 genesis - schienale in plastica colorato a vista genesis - plastic back coloured at sight

code	finishing	q.kit	q.pack	a	b	c	kg.x1	vol.x1
132103-100	● nero/black	x1	10	530	205	395	1,05	mc. 0.017
132105-100	● bianco/white	x1	10	530	205	395	1,05	mc. 0.017
132104-100	● grigio/grey	x1	10	530	205	395	1,05	mc. 0.017
132115-100	● blu/blue	x1	10	530	205	395	1,05	mc. 0.017

03 genesis - sedile in plastica colorato a vista genesis - plastic seat coloured at sight

code	finishing	q.kit	q.pack	a	b	c	kg.x1	vol.x1
132203-091	● nero/black	x1	10	460	500	55	0,95	mc. 0.017
132205-091	● bianco/white	x1	10	460	500	55	0,95	mc. 0.017
132204-091	● grigio/grey	x1	10	460	500	55	0,95	mc. 0.017
132215-091	● blu/blue	x1	10	460	500	55	0,95	mc. 0.017

04 genesis - sottosedile in plastica per telaio 4 gambe e slitta + paracolpi a testa bombata in pvc genesis - outer plastic seat for four legs and slide + pvc round head bumper

code	finishing	q.kit	q.pack	a	b	c	kg.x1	vol.x1
132203-092	● nero/black	x1	10	505	495	50	0,75	mc. 0.017
132205-092	● bianco/white	x1	10	505	495	50	0,75	mc. 0.017
132204-092	● grigio/grey	x1	10	505	495	50	0,75	mc. 0.017
132215-092	● blu/blue	x1	10	505	495	50	0,75	mc. 0.017

05 genesis - tappi schienale senza braccioli + coppia accessori per sedile senza braccioli genesis - caps for back without arms + pair of accessories for seat without arms

code	finishing	q.kit	q.pack	kg.x1
131703-104	● nero/black	x1	10	0,015
131705-104	● bianco/white	x1	10	0,015
131704-104	● grigio/grey	x1	10	0,015
131715-104	● blu/blue	x1	10	0,015

06 genesis - confezione puntali tondi d.22 neri genesis - black inner round flat caps d.22 package

code	finishing	q.kit	q.pack
137003-073	● nero/black	x4	290

07 genesis - coppia agganci laterali maschio + femmina cromati genesis - chrome lateral hooks male + female

code	finishing	q.kit	kg.x1	vol.x1
113410-100	● cromato/chrome	x1	0,13	mc. 0.0004

32 genesis - carrello porta sedie con accessori genesis - chair trolley with accessories

code	finishing	q.kit
110803-444	● nero/black	x1

genesi

4-legs/frame options

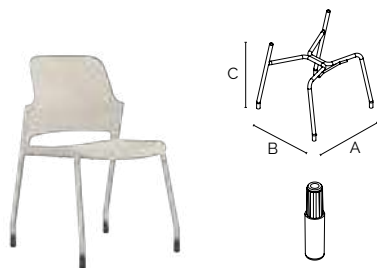

08 genesi - telaio 4 gambe per ruote e piedini alti
genesi - fixed 4 legs frame for castors and long glides

code	finishing	q.kit	q.pack	a	b	c	kg.x1	vol.x1
110103-571	● nero/black	x1	80	525	510	545	3.30	mc. 0.017
110105-571	● bianco/white	x1	80	525	510	545	3.30	mc. 0.017
110104-571	● grigio/grey	x1	80	525	510	545	3.30	mc. 0.017
110110-571	● cromato/chrome	x1	80	525	510	545	3.30	mc. 0.017

09 genesi - piedino alto (per telaio per ruote)
genesi - long glide (for castors frame)

code	finishing	q.kit
134303-064	● nero/black	x4

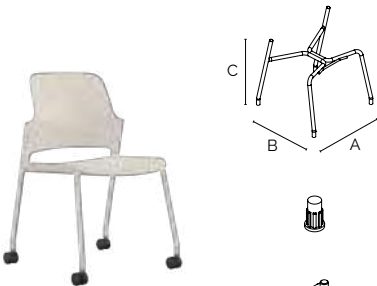

08 genesi - telaio 4 gambe per ruote e piedini alti
genesi - fixed 4 legs frame for castors and long glides

code	finishing	q.kit	q.pack	a	b	c	kg.x1	vol.x1
110103-571	● nero/black	x1	80	525	510	545	3.30	mc. 0.017
110105-571	● bianco/white	x1	80	525	510	545	3.30	mc. 0.017
110104-571	● grigio/grey	x1	80	525	510	545	3.30	mc. 0.017
110110-571	● cromato/chrome	x1	80	525	510	545	3.30	mc. 0.017

10 genesi - riduttore rigato per ruote (per telaio per ruote)
genesi - striped adapter for castors (for castors frame)

code	finishing	q.kit
134303-051	● nero/black	x4

11 genesi - doppia ruota d.50 in desmopan con perno montato
genesi - twin wheel castor d.50 desmopan with pivot mounted

code	finishing	q.kit	kg.x1
134403-003	● nero/black	x5	0.05

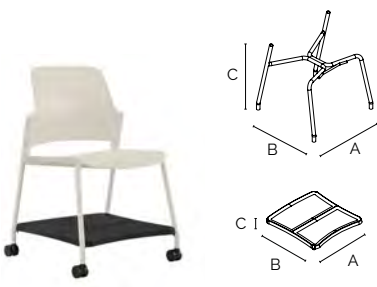

12 genesi - telaio 4 gambe con fori per cestello porta oggetti per ruote e piedini alti
genesi - fixed 4 legs frame with holes for storage basket for castors and long glides

code	finishing	q.kit	q.pack	a	b	c	kg.x1	vol.x1
110103-573	● nero/black	x1	80	525	510	545	3.30	mc. 0.017
110105-573	● bianco/white	x1	80	525	510	545	3.30	mc. 0.017
110104-573	● grigio/grey	x1	80	525	510	545	3.30	mc. 0.017
110110-573	● cromato/chrome	x1	80	525	510	545	3.30	mc. 0.017

13 genesi - vassoio portaoggetti
genesi - storage tray

code	finishing	q.kit	q.pack	a	b	c
134003-225	● nero/black	x1	10	512	530	40

14 genesi - vite autoflettante TC* 5,5x19 zincata bianca (per vassoio porta borse)
genesi - screw auto-thread TC5,5x19 cylindrical head zinc

code	finishing	q.kit
117811-180	● zincata/zinc-plated	x4

4-legs/backrest options

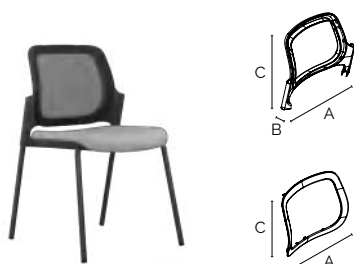

15 genesi - telaio schienale in plastica portante
genesi - outer back frame in plastic

code	finishing	q.kit	q.pack	a	b	c	kg.x1	vol.x1
132103-101	● nero/black	x1	10	530	220	405	0.75	mc. 0.017
132105-101	● bianco/white	x1	10	530	220	405	0.75	mc. 0.017
132104-101	● grigio/grey	x1	10	530	220	405	0.75	mc. 0.017
132115-101	● blu/blue	x1	10	530	220	405	0.75	mc. 0.017

16 genesi - cornice schienale in plastica per rete
genesi - open frame in plastic for mesh

code	finishing	q.kit	q.pack	a	b	c	kg.x1	vol.x1
132103-103	● nero/black	x1	10	425	140	355	0.30	mc. 0.004
132105-103	● bianco/white	x1	10	425	140	355	0.30	mc. 0.004
132104-103	● grigio/grey	x1	10	425	140	355	0.30	mc. 0.004
132115-103	● blu/blue	x1	10	425	140	355	0.30	mc. 0.004

15 genesi - telaio schienale in plastica portante
genesi - outer back frame in plastic

code	finishing	q.kit	q.pack	a	b	c	kg.x1	vol.x1
132103-101	● nero/black	x1	10	530	220	405	0.75	mc. 0.017
132105-101	● bianco/white	x1	10	530	220	405	0.75	mc. 0.017
132104-101	● grigio/grey	x1	10	530	220	405	0.75	mc. 0.017
132115-101	● blu/blue	x1	10	530	220	405	0.75	mc. 0.017

17 genesi - pannello in plastica schienale da tappezzare
genesi - plastic panel back for upholstery

code	finishing	q.kit	q.pack	a	b	c	kg.x1	vol.x1
132103-102	● nero/black	x1	10	425	140	355	0.674	mc. 0.004
132105-102	● bianco/white	x1	10	425	140	355	0.674	mc. 0.004
132104-102	● grigio/grey	x1	10	425	140	355	0.674	mc. 0.004
132115-102	● blu/blue	x1	10	425	140	355	0.674	mc. 0.004

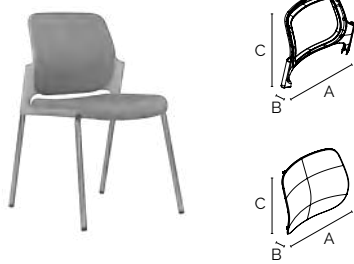

genesis

4-legs with armrests

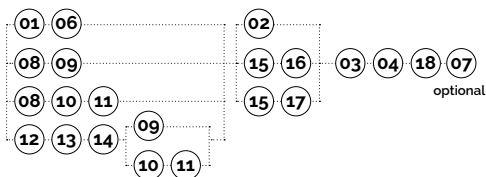
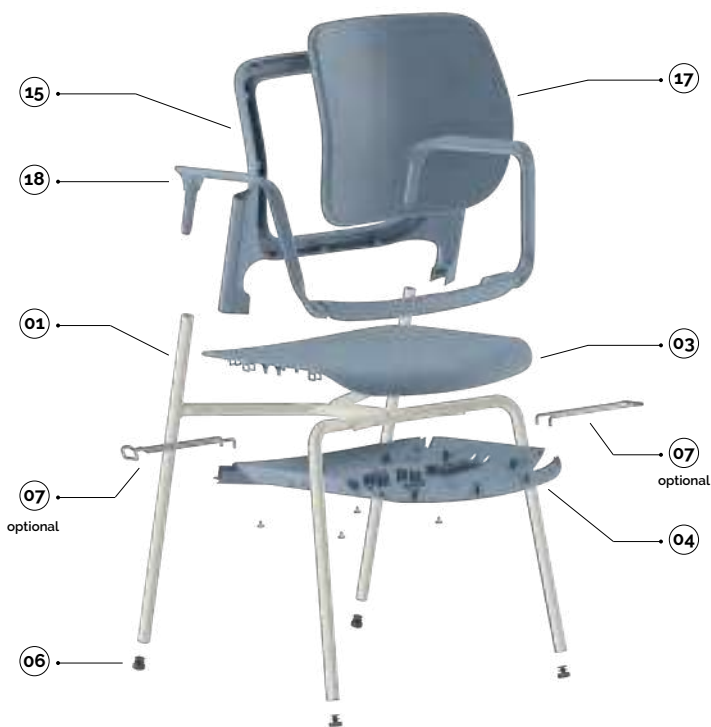
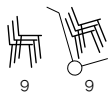

plastic colours

- nero/black
- bianco/white
- grigio/grey
- blu/blue

main component sizes

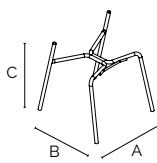

01

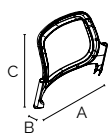

15

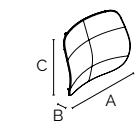

17

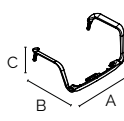

18

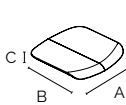

03

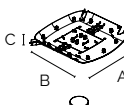

04



06



07

01 genesis - telaio 4 gambe ø.22 senza tappi
genesis - 4 legs frame ø.22 without caps

code	finishing	q.kit	q.pack	a	b	c	kg.x1	vol.x1
110103-564	● nero/black	x1	72	545	555	605	3,92	mc. 0,08
110105-564	● bianco/white	x1	72	545	555	605	3,92	mc. 0,08
110104-564	● grigio/grey	x1	72	545	555	605	3,92	mc. 0,08
110110-564	● cromato/chrome	x1	72	545	555	605	3,92	mc. 0,08

15 genesis - telaio schienale in plastica portante
genesis - outer back frame in plastic

code	finishing	q.kit	q.pack	a	b	c	kg.x1	vol.x1
132103-101	● nero/black	x1	10	530	220	405	0,75	mc. 0,017
132105-101	● bianco/white	x1	10	530	220	405	0,75	mc. 0,017
132104-101	● grigio/grey	x1	10	530	220	405	0,75	mc. 0,017
132115-101	● blu/blue	x1	10	530	220	405	0,75	mc. 0,017

17 genesis - pannello in plastica schienale da tappezzare
genesis - plastic panel back for upholstery

code	finishing	q.kit	q.pack	a	b	c	kg.x1	vol.x1
132103-102	● nero/black	x1	10	425	140	355	0,674	mc. 0,004
132105-102	● bianco/white	x1	10	425	140	355	0,674	mc. 0,004
132104-102	● grigio/grey	x1	10	425	140	355	0,674	mc. 0,004
132115-102	● blu/blue	x1	10	425	140	355	0,674	mc. 0,004

18 genesis - struttura braccioli in plastica
genesis - plastic arms structure

code	finishing	q.kit	q.pack	a	b	c	kg.x1	vol.x1
131703-100	● nero/black	x1	5	620	345	365	1,00	mc. 0,0183
131705-100	● bianco/white	x1	5	620	345	365	1,00	mc. 0,0183
131704-100	● grigio/grey	x1	5	620	345	365	1,00	mc. 0,0183
131715-100	● blu/blue	x1	5	620	345	365	1,00	mc. 0,0183

03 genesis - sedile in plastica colorato a vista
genesis - plastic seat coloured at sight

code	finishing	q.kit	q.pack	a	b	c	kg.x1	vol.x1
132203-091	● nero/black	x1	10	460	500	55	0,95	mc. 0,017
132205-091	● bianco/white	x1	10	460	500	55	0,95	mc. 0,017
132204-091	● grigio/grey	x1	10	460	500	55	0,95	mc. 0,017
132215-091	● blu/blue	x1	10	460	500	55	0,95	mc. 0,017

04 genesis - sottosedile in plastica per telaio 4 gambe e slitta + paracolpi a testa bombata in pvc
genesis - outer plastic seat for four legs and slide + pvc round head bumper

code	finishing	q.kit	q.pack	a	b	c	kg.x1	vol.x1
132203-092	● nero/black	x1	10	505	495	50	0,75	mc. 0,017
132205-092	● bianco/white	x1	10	505	495	50	0,75	mc. 0,017
132204-092	● grigio/grey	x1	10	505	495	50	0,75	mc. 0,017
132215-092	● blu/blue	x1	10	505	495	50	0,75	mc. 0,017

06 genesis - confezione puntali tondi d.22 neri
genesis - black inner round flat caps d.22 package

code	finishing	q.kit	q.pack
137003-073	● nero/black	x4	290

07 genesis - coppia agganci laterali maschio + femmina cromati
genesis - chrome lateral hooks male + female

code	finishing	q.kit	kg.x1	vol.x1
113410-100	● cromato/chrome	x1	0,13	mc. 0,0004

genesis

4-legs with armrests/frame options

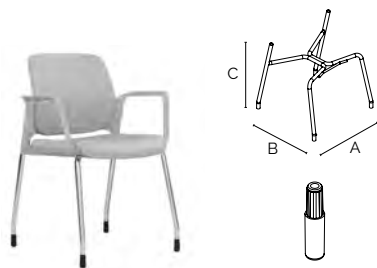

08 genesis - telaio 4 gambe per ruote e piedini alti
genesis - fixed 4 legs frame for castors and long glides

code	finishing	q.kit	q.pack	a	b	c	kg.x1	vol.x1
110103-571	● nero/black	x1	80	525	510	545	3,30	mc. 0,017
110105-571	● bianco/white	x1	80	525	510	545	3,30	mc. 0,017
110104-571	● grigio/grey	x1	80	525	510	545	3,30	mc. 0,017
110110-571	● cromato/chrome	x1	80	525	510	545	3,30	mc. 0,017

09 genesis - piedino alto (per telaio per ruote)
genesis - long glide (for castors frame)

code	finishing	q.kit
134303-064	● nero/black	x4

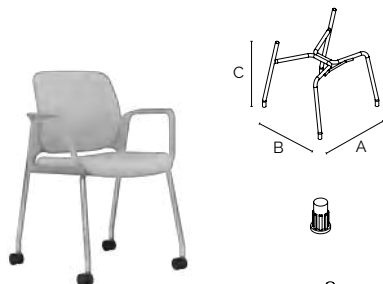

08 genesis - telaio 4 gambe per ruote e piedini alti
genesis - fixed 4 legs frame for castors and long glides

code	finishing	q.kit	q.pack	a	b	c	kg.x1	vol.x1
110103-571	● nero/black	x1	80	525	510	545	3,30	mc. 0,017
110105-571	● bianco/white	x1	80	525	510	545	3,30	mc. 0,017
110104-571	● grigio/grey	x1	80	525	510	545	3,30	mc. 0,017
110110-571	● cromato/chrome	x1	80	525	510	545	3,30	mc. 0,017

10 genesis - riduttore rigato per ruote (per telaio per ruote)
genesis - striped adapter for castors (for castors frame)

code	finishing	q.kit
134303-051	● nero/black	x4

11 genesis - doppia ruota d.50 in desmopan con perno montato
genesis - twin wheel castor d.50 desmopan with pivot mounted

code	finishing	q.kit	kg.x1
134403-003	● nero/black	x5	0,05

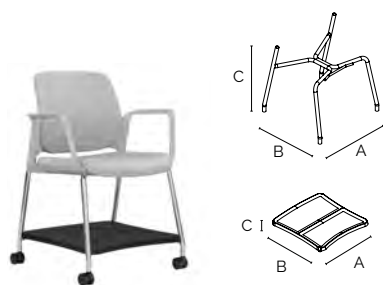

12 genesis - telaio 4 gambe con fori per cestello porta oggetti per ruote e piedini alti
genesis - fixed 4 legs frame with holes for storage basket for castors and long glides

code	finishing	q.kit	q.pack	a	b	c	kg.x1	vol.x1
110103-573	● nero/black	x1	80	525	510	545	3,30	mc. 0,017
110105-573	● bianco/white	x1	80	525	510	545	3,30	mc. 0,017
110104-573	● grigio/grey	x1	80	525	510	545	3,30	mc. 0,017
110110-573	● cromato/chrome	x1	80	525	510	545	3,30	mc. 0,017

13 genesis - vassoio portaoggetti
genesis - storage tray

code	finishing	q.kit	q.pack	a	b	c
134003-225	● nero/black	x1	10	512	530	40

14 genesis - vite autoflettante TC* 5,5x19 zincata bianca (per vassoio porta borse)
genesis - screw auto-thread TC5,5x19 cylindrical head zinc

code	finishing	q.kit
117811-180	● zincata/zinc-plated	x4

4-legs with armrests/backrest options

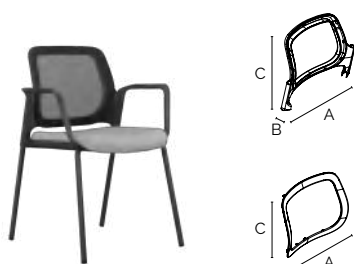

15 genesis - telaio schienale in plastica portante
genesis - outer back frame in plastic

code	finishing	q.kit	q.pack	a	b	c	kg.x1	vol.x1
132103-101	● nero/black	x1	10	530	220	405	0,75	mc. 0,017
132105-101	● bianco/white	x1	10	530	220	405	0,75	mc. 0,017
132104-101	● grigio/grey	x1	10	530	220	405	0,75	mc. 0,017
132115-101	● blu/blue	x1	10	530	220	405	0,75	mc. 0,017

16 genesis - cornice schienale in plastica per rete
genesis - open frame in plastic for mesh

code	finishing	q.kit	q.pack	a	b	c	kg.x1	vol.x1
132103-103	● nero/black	x1	10	425	140	355	0,30	mc. 0,004
132105-103	● bianco/white	x1	10	425	140	355	0,30	mc. 0,004
132104-103	● grigio/grey	x1	10	425	140	355	0,30	mc. 0,004
132115-103	● blu/blue	x1	10	425	140	355	0,30	mc. 0,004

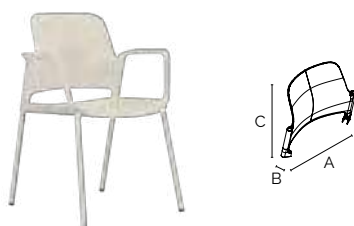

02 genesis - schienale in plastica colorato a vista
genesis - plastic back coloured at sight

code	finishing	q.kit	q.pack	a	b	c	kg.x1	vol.x1
132103-100	● nero/black	x1	10	530	205	395	1,05	mc. 0,017
132105-100	● bianco/white	x1	10	530	205	395	1,05	mc. 0,017
132104-100	● grigio/grey	x1	10	530	205	395	1,05	mc. 0,017
132115-100	● blu/blue	x1	10	530	205	395	1,05	mc. 0,017

genesis

4-legs with writing tablet

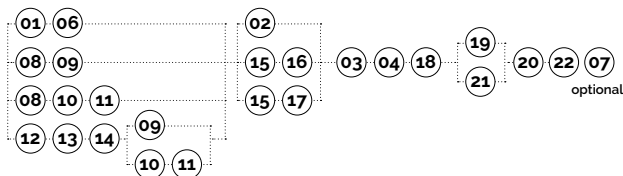

plastic colours

- nero/black
- bianco/white
- grigio/grey
- blu/blue

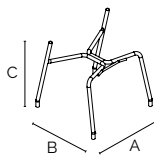

12

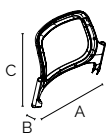

15

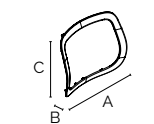

16

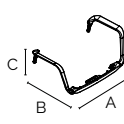

18

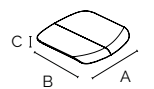

03

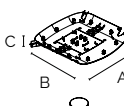

04



19

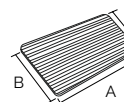

22

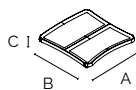

13



10



11

main component sizes

12 genesis - telaio 4 gambe con fori per cestello porta oggetti per ruote e piedini alti
genesis - fixed 4 legs frame with holes for storage basket for castors and long glides

code	finishing	q.kit	q.pack	a	b	c	kg.x1	vol.x1
110103-573	● nero/black	x1	80	525	510	545	3,30	mc. 0.017
110105-573	● bianco/white	x1	80	525	510	545	3,30	mc. 0.017
110104-573	● grigio/grey	x1	80	525	510	545	3,30	mc. 0.017
110110-573	● cromato/chrome	x1	80	525	510	545	3,30	mc. 0.017

15 genesis - telaio schienale in plastica portante
genesis - outer back frame in plastic

code	finishing	q.kit	q.pack	a	b	c	kg.x1	vol.x1
132103-101	● nero/black	x1	10	530	220	405	0,75	mc. 0.017
132105-101	● bianco/white	x1	10	530	220	405	0,75	mc. 0.017
132104-101	● grigio/grey	x1	10	530	220	405	0,75	mc. 0.017
132115-101	● blu/blue	x1	10	530	220	405	0,75	mc. 0.017

16 genesis - cornice schienale in plastica per rete
genesis - open frame in plastic for mesh

code	finishing	q.kit	q.pack	a	b	c	kg.x1	vol.x1
132103-103	● nero/black	x1	10	425	140	355	0,30	mc. 0.004
132105-103	● bianco/white	x1	10	425	140	355	0,30	mc. 0.004
132104-103	● grigio/grey	x1	10	425	140	355	0,30	mc. 0.004
132115-103	● blu/blue	x1	10	425	140	355	0,30	mc. 0.004

18 genesis - struttura braccioli in plastica
genesis - plastic arms structure

code	finishing	q.kit	q.pack	a	b	c	kg.x1	vol.x1
131703-100	● nero/black	x1	5	620	345	365	1,00	mc. 0.0183
131705-100	● bianco/white	x1	5	620	345	365	1,00	mc. 0.0183
131704-100	● grigio/grey	x1	5	620	345	365	1,00	mc. 0.0183
131715-100	● blu/blue	x1	5	620	345	365	1,00	mc. 0.0183

19 genesis - supporto destro per tavoletta
genesis - right support for writing table

code	finishing	q.kit	q.pack
131703-101	● nero/black	x1	/
131705-101	● bianco/white	x1	/
131704-101	● grigio/grey	x1	/
131715-101	● blu/blue	x1	/

22 tl02.cfd - tavoletta legno c/prefori dx verniciata faggio
tl02.cfd - right painted beechwood tablet

code	finishing	q.kit	q.pack	a	b	c	kg.x1	vol.x1
120307-021	● faggio/beech	x1	10	342	245	196	0,65	mc. 0.009

13 genesis - vassoio portaoggetti
genesis - storage tray

code	finishing	q.kit	q.pack	a	b	c
134003-225	● nero/black	x1	10	512	530	40

14 genesis - vite autoflettante TC+ 5,5x19 zincata bianca (per vassoio porta borse)
genesis - screw auto-thread TC5,5x19 cylindrical head zinc

code	finishing	q.kit
117811-180	● zincata/zinc-plated	x4

10 genesis - riduttore rigato per ruote (per telaio per ruote)
genesis - striped adapter for castors (for castors frame)

code	finishing	q.kit
134303-051	● nero/black	x4

11 genesis - doppia ruota d.50 in desmopan con perno montato
genesis - twin wheel castor d.50 desmopan with pivot mounted

code	finishing	q.kit	kg.x1
134403-003	● nero/black	x5	0,05

for the components below.
see previous pages

03 04 07

genesis

4-legs with writing tablet/frame options

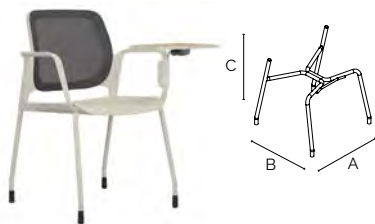

08 genesis - telaio 4 gambe per ruote e piedini alti
genesis - fixed 4 legs frame for castors and long glides

code	finishing	q.kit	q.pack	a	b	c	kg.x1	vol.x1
110103-571	● nero/black	x1	80	525	510	545	3,30	mc. 0,017
110105-571	● bianco/white	x1	80	525	510	545	3,30	mc. 0,017
110104-571	● grigio/grey	x1	80	525	510	545	3,30	mc. 0,017
110110-571	● cromato/chrome	x1	80	525	510	545	3,30	mc. 0,017

and · **09**



08 genesis - telaio 4 gambe per ruote e piedini alti
genesis - fixed 4 legs frame for castors and long glides

code	finishing	q.kit	q.pack	a	b	c	kg.x1	vol.x1
110103-571	● nero/black	x1	80	525	510	545	3,30	mc. 0,017
110105-571	● bianco/white	x1	80	525	510	545	3,30	mc. 0,017
110104-571	● grigio/grey	x1	80	525	510	545	3,30	mc. 0,017
110110-571	● cromato/chrome	x1	80	525	510	545	3,30	mc. 0,017

and · **10** · **11**

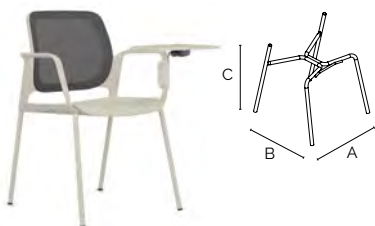

01 genesis - telaio 4 gambe ø.22 senza tappi
genesis - 4 legs frame ø.22 without caps

code	finishing	q.kit	q.pack	a	b	c	kg.x1	vol.x1
110103-564	● nero/black	x1	72	545	555	605	3,92	mc. 0,08
110105-564	● bianco/white	x1	72	545	555	605	3,92	mc. 0,08
110104-564	● grigio/grey	x1	72	545	555	605	3,92	mc. 0,08
110110-564	● cromato/chrome	x1	72	545	555	605	3,92	mc. 0,08

and · **06**

writing tablet options



21 genesis - supporto sinistro per tavoletta
genesis - left support for writing table

code	finishing	q.kit	q.pack
131703-102	● nero/black	x1	/
131705-102	● bianco/white	x1	/
131704-102	● grigio/grey	x1	/
131715-102	● blu/blue	x1	/

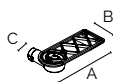

20 genesis - snodo antipanico SPTA per fissaggio tavoletta
genesis - SPTA safety joint for tablet attachment

code	finishing		q.kit	q.pack	a	b	c	kg.x1	vol.x1
111701-900	● alluminio/aluminium	destra/right	x1	10	180	66	15x15	0,365	mc. 0,001
111701-901	● alluminio/aluminium	sinistra/left	x1	10	180	66	15x15	0,365	mc. 0,001

TLT tablet TLT2 tablet TLT3 tablet BEAN tablet TL02 tablet SPT2 mechanism tablet SPTA mechanism antipanic



for writing tablet options, see page 404/405

4-legs with writing tablet/backrest options



15 genesis - telaio schienale in plastica portante
genesis - outer back frame in plastic

code	finishing	q.kit	q.pack	a	b	c	kg.x1	vol.x1
132103-101	● nero/black	x1	10	530	220	405	0,75	mc. 0,017
132105-101	● bianco/white	x1	10	530	220	405	0,75	mc. 0,017
132104-101	● grigio/grey	x1	10	530	220	405	0,75	mc. 0,017
132115-101	● blu/blue	x1	10	530	220	405	0,75	mc. 0,017

and · **17**



02 genesis - schienale in plastica colorato a vista
genesis - plastic back coloured at sight

code	finishing	q.kit	q.pack	a	b	c	kg.x1	vol.x1
132103-100	● nero/black	x1	10	530	205	395	1,05	mc. 0,017
132105-100	● bianco/white	x1	10	530	205	395	1,05	mc. 0,017
132104-100	● grigio/grey	x1	10	530	205	395	1,05	mc. 0,017
132115-100	● blu/blue	x1	10	530	205	395	1,05	mc. 0,017

genesis

cantilever

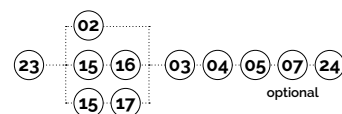
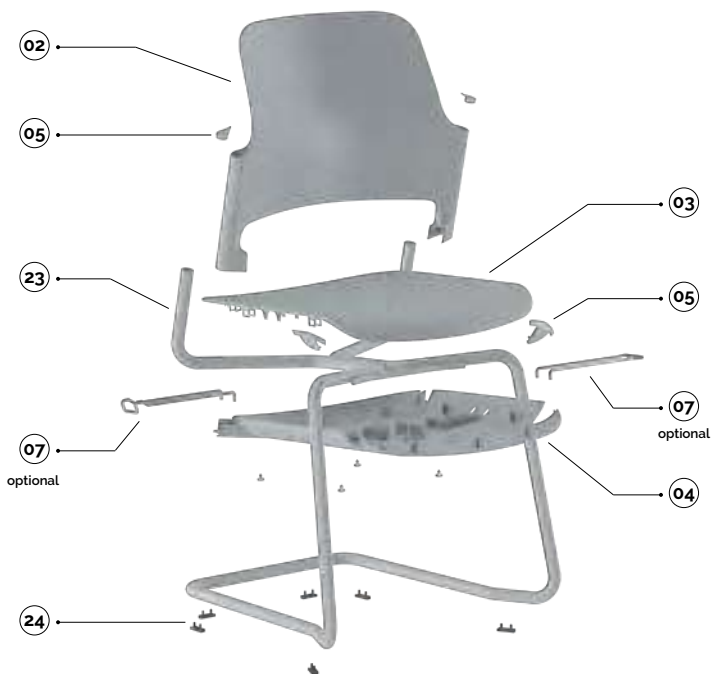

plastic colours

- nero/black
- bianco/white
- grigio/grey
- blu/blue

main component sizes

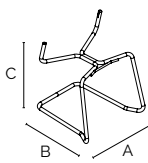

23

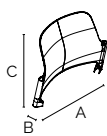

02

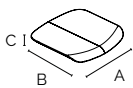

03

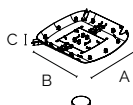

04



05



24

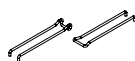

07

23 genesis - base a slitta in tubo asform d.22 tappi esclusi

genesis - cantilever frame asform pipe d.22 without caps

code	finishing	q.kit	q.pack	a	b	c	kg.x1	vol.x1
110503-594	● nero/black	x1	50	530	515	605	4.60	mc. 0.06
110505-594	● bianco/white	x1	50	530	515	605	4.60	mc. 0.06
110504-594	● grigio/grey	x1	50	530	515	605	4.60	mc. 0.06
110510-594	● cromato/chrome	x1	50	530	515	605	4.60	mc. 0.06

02 genesis - schienale in plastica colorato a vista

genesis - plastic back coloured at sight

code	finishing	q.kit	q.pack	a	b	c	kg.x1	vol.x1
132103-100	● nero/black	x1	10	530	205	395	1.05	mc. 0.017
132105-100	● bianco/white	x1	10	530	205	395	1.05	mc. 0.017
132104-100	● grigio/grey	x1	10	530	205	395	1.05	mc. 0.017
132115-100	● blu/blue	x1	10	530	205	395	1.05	mc. 0.017

03 genesis - sedile in plastica colorato a vista

genesis - plastic seat coloured at sight

code	finishing	q.kit	q.pack	a	b	c	kg.x1	vol.x1
132203-091	● nero/black	x1	10	460	500	55	0.95	mc. 0.017
132205-091	● bianco/white	x1	10	460	500	55	0.95	mc. 0.017
132204-091	● grigio/grey	x1	10	460	500	55	0.95	mc. 0.017
132215-091	● blu/blue	x1	10	460	500	55	0.95	mc. 0.017

04 genesis - sottosedile in plastica per telaio 4 gambe e slitta + paracolpi a testa bombata in pvc

genesis - outer plastic seat for four legs and slide + pvc round head bumper

code	finishing	q.kit	q.pack	a	b	c	kg.x1	vol.x1
132203-092	● nero/black	x1	10	505	495	50	0.75	mc. 0.017
132205-092	● bianco/white	x1	10	505	495	50	0.75	mc. 0.017
132204-092	● grigio/grey	x1	10	505	495	50	0.75	mc. 0.017
132215-092	● blu/blue	x1	10	505	495	50	0.75	mc. 0.017

05 genesis - tappi schienale senza braccioli + coppia accessori per sedile senza braccioli

genesis - caps for back without arms + pair of accessories for seat without arms

code	finishing	q.kit	q.pack	kg.x1
131703-104	● nero/black	x1	10	0.015
131705-104	● bianco/white	x1	10	0.015
131704-104	● grigio/grey	x1	10	0.015
131715-104	● blu/blue	x1	10	0.015

24 genesis - pinza due pioli in polietilene nera

genesis - two pins pliers in black polythene

code	finishing	q.kit
134003-003	● nero/black	x6

07 genesis - coppia agganci laterali maschio + femmina cromati

genesis - chrome lateral hooks male + female

code	finishing	q.kit	kg.x1	vol.x1
113410-100	● cromato/chrome	x1	0.13	mc. 0.0004

genesis

cantilever/backrest options

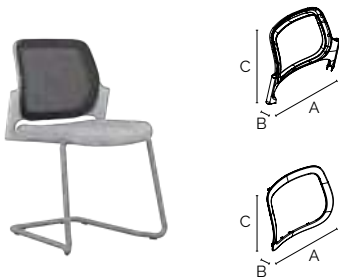

15 genesis - telaio schienale in plastica portante

genesis - outer back frame in plastic

code	finishing	q.kit	q.pack	a	b	c	kg.x1	vol.x1
132103-101	● nero/black	x1	10	530	220	405	0,75	mc. 0,017
132105-101	● bianco/white	x1	10	530	220	405	0,75	mc. 0,017
132104-101	● grigio/grey	x1	10	530	220	405	0,75	mc. 0,017
132115-101	● blu/blue	x1	10	530	220	405	0,75	mc. 0,017

16 genesis - cornice schienale in plastica per rete

genesis - open frame in plastic for mesh

code	finishing	q.kit	q.pack	a	b	c	kg.x1	vol.x1
132103-103	● nero/black	x1	10	425	140	355	0,30	mc. 0,004
132105-103	● bianco/white	x1	10	425	140	355	0,30	mc. 0,004
132104-103	● grigio/grey	x1	10	425	140	355	0,30	mc. 0,004
132115-103	● blu/blue	x1	10	425	140	355	0,30	mc. 0,004

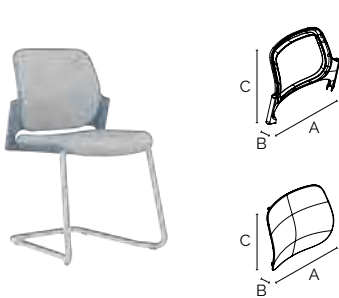

15 genesis - telaio schienale in plastica portante

genesis - outer back frame in plastic

code	finishing	q.kit	q.pack	a	b	c	kg.x1	vol.x1
132103-101	● nero/black	x1	10	530	220	405	0,75	mc. 0,017
132105-101	● bianco/white	x1	10	530	220	405	0,75	mc. 0,017
132104-101	● grigio/grey	x1	10	530	220	405	0,75	mc. 0,017
132115-101	● blu/blue	x1	10	530	220	405	0,75	mc. 0,017

17 genesis - pannello in plastica schienale da tappezzare

genesis - plastic panel back for upholstery

code	finishing	q.kit	q.pack	a	b	c	kg.x1	vol.x1
132103-102	● nero/black	x1	10	425	140	355	0,674	mc. 0,004
132105-102	● bianco/white	x1	10	425	140	355	0,674	mc. 0,004
132104-102	● grigio/grey	x1	10	425	140	355	0,674	mc. 0,004
132115-102	● blu/blue	x1	10	425	140	355	0,674	mc. 0,004

genesis

cantilever with armrests

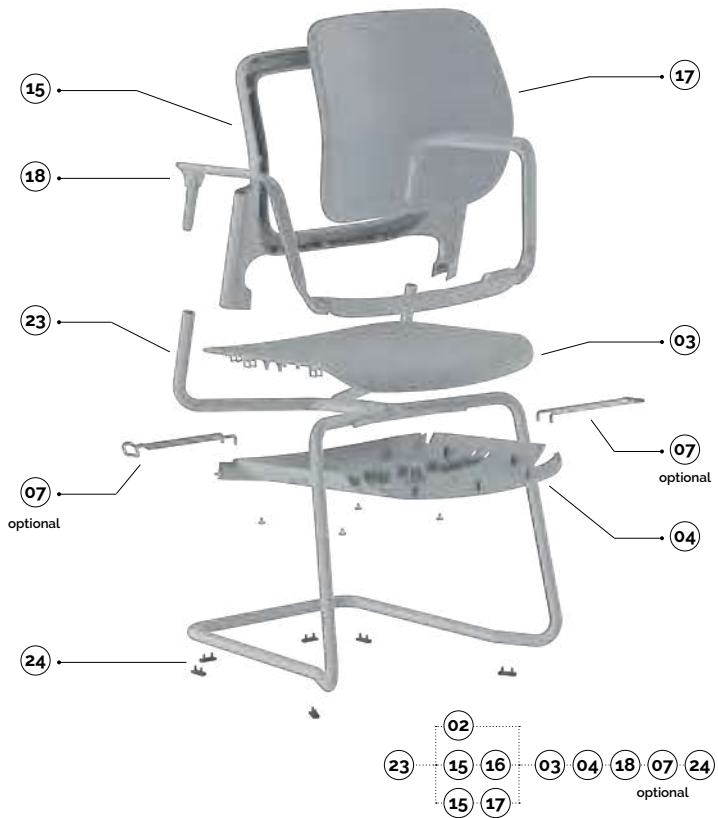

plastic colours

- nero/black
- bianco/white
- grigio/grey
- blu/blue

main component sizes

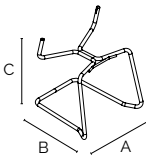

23

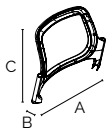

15

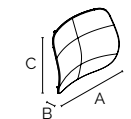

03

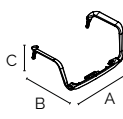

18

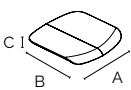

03

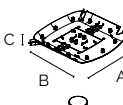

04



24

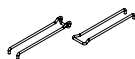

07

23 genesis - base a slitta in tubo asform d.22 tappi esclusi
genesis - cantilever frame asform pipe d.22 without caps

code	finishing	q.kit	q.pack	a	b	c	kg.x1	vol.x1
110503-594	● nero/black	x1	50	530	515	605	4,60	mc. 0,06
110505-594	● bianco/white	x1	50	530	515	605	4,60	mc. 0,06
110504-594	● grigio/grey	x1	50	530	515	605	4,60	mc. 0,06
110510-594	● cromato/chrome	x1	50	530	515	605	4,60	mc. 0,06

15 genesis - telaio schienale in plastica portante
genesis - outer back frame in plastic

code	finishing	q.kit	q.pack	a	b	c	kg.x1	vol.x1
132103-101	● nero/black	x1	10	530	220	405	0,75	mc. 0,017
132105-101	● bianco/white	x1	10	530	220	405	0,75	mc. 0,017
132104-101	● grigio/grey	x1	10	530	220	405	0,75	mc. 0,017
132115-101	● blu/blue	x1	10	530	220	405	0,75	mc. 0,017

17 genesis - pannello in plastica schienale da tappezzare
genesis - plastic panel back for upholstery

code	finishing	q.kit	q.pack	a	b	c	kg.x1	vol.x1
132103-102	● nero/black	x1	10	425	140	355	0,674	mc. 0,004
132105-102	● bianco/white	x1	10	425	140	355	0,674	mc. 0,004
132104-102	● grigio/grey	x1	10	425	140	355	0,674	mc. 0,004
132115-102	● blu/blue	x1	10	425	140	355	0,674	mc. 0,004

18 genesis - struttura braccioli in plastica
genesis - plastic arms structure

code	finishing	q.kit	q.pack	a	b	c	kg.x1	vol.x1
131703-100	● nero/black	x1	5	620	345	365	1,00	mc. 0,0183
131705-100	● bianco/white	x1	5	620	345	365	1,00	mc. 0,0183
131704-100	● grigio/grey	x1	5	620	345	365	1,00	mc. 0,0183
131715-100	● blu/blue	x1	5	620	345	365	1,00	mc. 0,0183

03 genesis - sedile in plastica colorato a vista
genesis - plastic seat coloured at sight

code	finishing	q.kit	q.pack	a	b	c	kg.x1	vol.x1
132203-091	● nero/black	x1	10	460	500	55	0,95	mc. 0,017
132205-091	● bianco/white	x1	10	460	500	55	0,95	mc. 0,017
132204-091	● grigio/grey	x1	10	460	500	55	0,95	mc. 0,017
132215-091	● blu/blue	x1	10	460	500	55	0,95	mc. 0,017

04 genesis - sottosedile in plastica per telaio 4 gambe e slitta + paracolpi a testa bombata in pvc
genesis - outer plastic seat for four legs and slide + pvc round head bumper

code	finishing	q.kit	q.pack	a	b	c	kg.x1	vol.x1
132203-092	● nero/black	x1	10	505	495	50	0,75	mc. 0,017
132205-092	● bianco/white	x1	10	505	495	50	0,75	mc. 0,017
132204-092	● grigio/grey	x1	10	505	495	50	0,75	mc. 0,017
132215-092	● blu/blue	x1	10	505	495	50	0,75	mc. 0,017

24 genesis - pinza due pioli in polietilene nera
genesis - two pins pliers in black polythene

code	finishing	q.kit
134003-003	● nero/black	x6

07 genesis - coppia agganci laterali maschio + femmina cromati
genesis - chrome lateral hooks male + female

code	finishing	q.kit	kg.x1	vol.x1
113410-100	● cromato/chrome	x1	0,13	mc. 0,0004

genesis

cantilever with armrests/backrest options

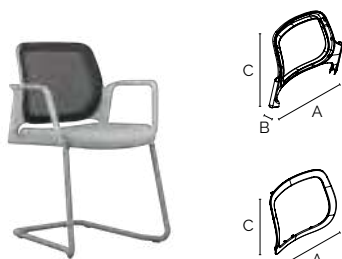

15 genesis - telaio schienale in plastica portante
genesis - outer back frame in plastic

code	finishing	q.kit	q.pack	a	b	c	kg.x1	vol.x1
132103-101	● nero/black	x1	10	530	220	405	0,75	mc. 0,017
132105-101	● bianco/white	x1	10	530	220	405	0,75	mc. 0,017
132104-101	● grigio/grey	x1	10	530	220	405	0,75	mc. 0,017
132115-101	● blu/blue	x1	10	530	220	405	0,75	mc. 0,017

16 genesis - cornice schienale in plastica per rete
genesis - open frame in plastic for mesh

code	finishing	q.kit	q.pack	a	b	c	kg.x1	vol.x1
132103-103	● nero/black	x1	10	425	140	355	0,30	mc. 0,004
132105-103	● bianco/white	x1	10	425	140	355	0,30	mc. 0,004
132104-103	● grigio/grey	x1	10	425	140	355	0,30	mc. 0,004
132115-103	● blu/blue	x1	10	425	140	355	0,30	mc. 0,004

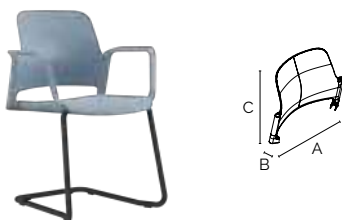

02 genesis - schienale in plastica colorato a vista
genesis - plastic back coloured at sight

code	finishing	q.kit	q.pack	a	b	c	kg.x1	vol.x1
132103-100	● nero/black	x1	10	530	205	395	1,05	mc. 0,017
132105-100	● bianco/white	x1	10	530	205	395	1,05	mc. 0,017
132104-100	● grigio/grey	x1	10	530	205	395	1,05	mc. 0,017
132115-100	● blu/blue	x1	10	530	205	395	1,05	mc. 0,017

genesis

cantilever with writing tablet

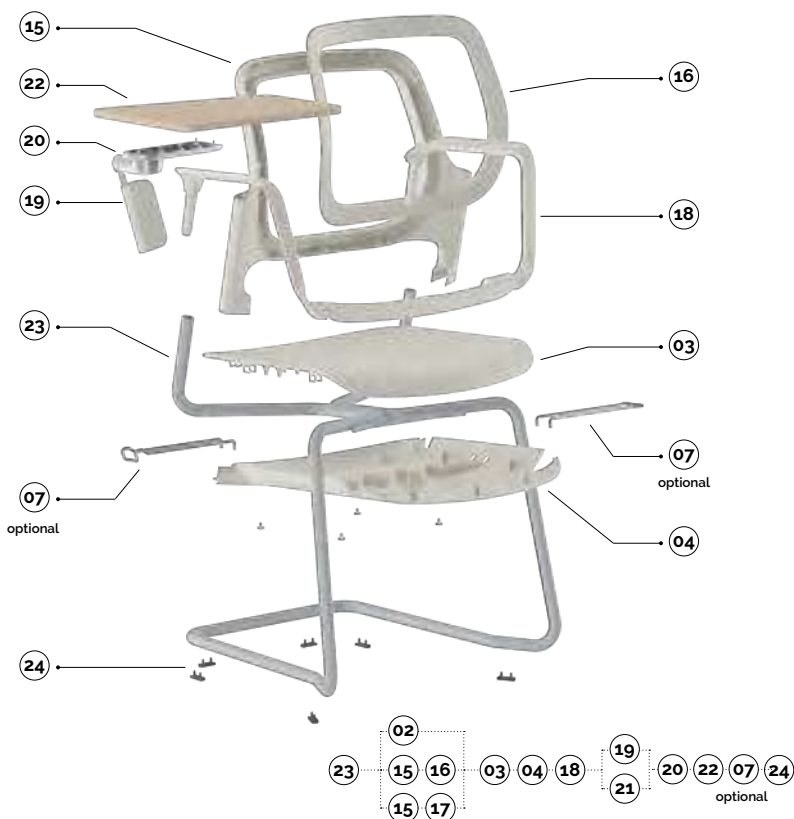

plastic colours

- nero/black
- bianco/white
- grigio/grey
- blu/blue

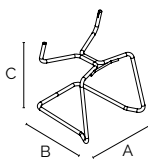

23

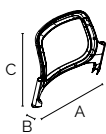

15

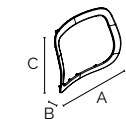

03

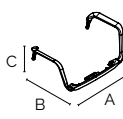

18

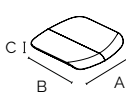

07

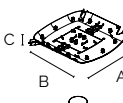

04



19

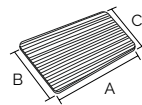

22



24

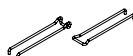

07

main component sizes

23 genesis - base a slitta in tubo asform d.22 tappi esclusi
genesis - cantilever frame asform pipe d.22 without caps

code	finishing	q.kit	q.pack	a	b	c	kg.x1	vol.x1
110503-594	● nero/black	x1	50	530	515	605	4,60	mc. 0,06
110505-594	● bianco/white	x1	50	530	515	605	4,60	mc. 0,06
110504-594	● grigio/grey	x1	50	530	515	605	4,60	mc. 0,06
110510-594	● cromato/chrome	x1	50	530	515	605	4,60	mc. 0,06

15 genesis - telaio schienale in plastica portante
genesis - open frame in plastic

code	finishing	q.kit	q.pack	a	b	c	kg.x1	vol.x1
132103-101	● nero/black	x1	10	530	220	405	0,75	mc. 0,017
132105-101	● bianco/white	x1	10	530	220	405	0,75	mc. 0,017
132104-101	● grigio/grey	x1	10	530	220	405	0,75	mc. 0,017
132115-101	● blu/blue	x1	10	530	220	405	0,75	mc. 0,017

16 genesis - cornice schienale in plastica per rete
genesis - open frame in plastic for mesh

code	finishing	q.kit	q.pack	a	b	c	kg.x1	vol.x1
132103-103	● nero/black	x1	10	425	140	355	0,30	mc. 0,004
132105-103	● bianco/white	x1	10	425	140	355	0,30	mc. 0,004
132104-103	● grigio/grey	x1	10	425	140	355	0,30	mc. 0,004
132115-103	● blu/blue	x1	10	425	140	355	0,30	mc. 0,004

18 genesis - struttura braccioli in plastica
genesis - plastic arms structure

code	finishing	q.kit	q.pack	a	b	c	kg.x1	vol.x1
131703-100	● nero/black	x1	5	620	345	365	1,00	mc. 0,0183
131705-100	● bianco/white	x1	5	620	345	365	1,00	mc. 0,0183
131704-100	● grigio/grey	x1	5	620	345	365	1,00	mc. 0,0183
131715-100	● blu/blue	x1	5	620	345	365	1,00	mc. 0,0183

19 genesis - supporto destro per tavoletta
genesis - right support for writing table

code	finishing	q.kit	q.pack
131703-101	● nero/black	x1	/
131705-101	● bianco/white	x1	/
131704-101	● grigio/grey	x1	/
131715-101	● blu/blue	x1	/

22 tl02.cfd - tavoletta legno c/prefori dx verniciata faggio
tl02.cfd - right painted beechwood tablet

code	finishing	q.kit	q.pack	a	b	c	kg.x1	vol.x1
120307-021	● faggio/beech	x1	10	342	245	196	0,65	mc. 0,009

24 genesis - pinza due pioli in polietilene nera
genesis - two pins pliers in black polythene

code	finishing	q.kit
134003-003	● nero/black	x6

07 genesis - coppia agganci laterali maschio + femmina cromati
genesis - chrome lateral hooks male + female

code	finishing	q.kit	kg.x1	vol.x1
113410-100	● cromato/chrome	x1	0,13	mc. 0,0004

for the components below,
see previous pages

03 04

genesis

cantilever with writing tablet/backrest options

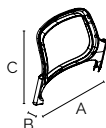

15 genesis - telaio schienale in plastica portante
genesis - outer back frame in plastic

code	finishing	q.kit	q.pack	a	b	c	kg.x1	vol.x1
132103-101	● nero/black	x1	10	530	220	405	0,75	mc. 0,017
132105-101	● bianco/white	x1	10	530	220	405	0,75	mc. 0,017
132104-101	● grigio/grey	x1	10	530	220	405	0,75	mc. 0,017
132115-101	● blu/blue	x1	10	530	220	405	0,75	mc. 0,017

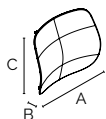

17 genesis - pannello in plastica schienale da tappezzare
genesis - plastic panel back for upholstery

code	finishing	q.kit	q.pack	a	b	c	kg.x1	vol.x1
132103-102	● nero/black	x1	10	425	140	355	0,674	mc. 0,004
132105-102	● bianco/white	x1	10	425	140	355	0,674	mc. 0,004
132104-102	● grigio/grey	x1	10	425	140	355	0,674	mc. 0,004
132115-102	● blu/blue	x1	10	425	140	355	0,674	mc. 0,004

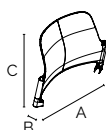

20 genesis - schienale in plastica colorato a vista
genesis - plastic back coloured at sight

code	finishing	q.kit	q.pack	a	b	c	kg.x1	vol.x1
132103-100	● nero/black	x1	10	530	205	395	1,05	mc. 0,017
132105-100	● bianco/white	x1	10	530	205	395	1,05	mc. 0,017
132104-100	● grigio/grey	x1	10	530	205	395	1,05	mc. 0,017
132115-100	● blu/blue	x1	10	530	205	395	1,05	mc. 0,017

writing tablet options



21 genesis - supporto sinistro per tavoletta
genesis - left support for writing table

code	finishing	q.kit	q.pack
131703-102	● nero/black	x1	/
131705-102	● bianco/white	x1	/
131704-102	● grigio/grey	x1	/
131715-102	● blu/blue	x1	/

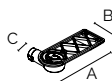

20 genesis - snodo antipanico SPTA per fissaggio tavoletta
genesis - SPTA safety joint for tablet attachment

code	finishing		q.kit	q.pack	a	b	c	kg.x1	vol.x1
111701-900	● alluminio/aluminium	destra/right	x1	10	180	66	15x15	0,365	mc. 0,001
111701-901	● alluminio/aluminium	sinistra/left	x1	10	180	66	15x15	0,365	mc. 0,001

TLT
tablet



TLT2
tablet



TLT3
tablet



BEAN
tablet



TL02
tablet



SPT2
mechanism tablet



SPTA
mechanism antipanico



for writing tablet options, see page 404/405

genesis

swivel

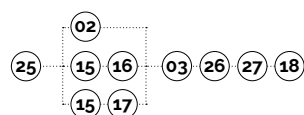

plastic colours

- nero/black
- bianco/white
- grigio/grey
- blu/blue

main component sizes

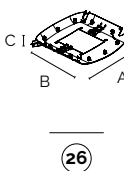
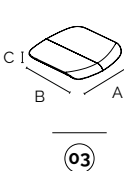
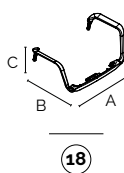
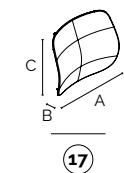
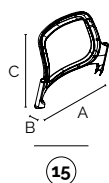
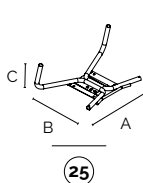

25 genesis - telaio per girevole comando a gas

genesis - swivel frame with gas lever

code	finishing	q.kit	q.pack	a	b	c	kg.x1	vol.x1
110903-297	● nero/black	x1	120	525	350	200	2,55	mc. 0,00704

15 genesis - telaio schienale in plastica portante

genesis - outer back frame in plastic

code	finishing	q.kit	q.pack	a	b	c	kg.x1	vol.x1
132103-101	● nero/black	x1	10	530	220	405	0,75	mc. 0,017
132105-101	● bianco/white	x1	10	530	220	405	0,75	mc. 0,017
132104-101	● grigio/grey	x1	10	530	220	405	0,75	mc. 0,017
132115-101	● blu/blue	x1	10	530	220	405	0,75	mc. 0,017

17 genesis - pannello in plastica schienale da tappezzare

genesis - plastic panel back for upholstery

code	finishing	q.kit	q.pack	a	b	c	kg.x1	vol.x1
132103-102	● nero/black	x1	10	425	140	355	0,674	mc. 0,004
132105-102	● bianco/white	x1	10	425	140	355	0,674	mc. 0,004
132104-102	● grigio/grey	x1	10	425	140	355	0,674	mc. 0,004
132115-102	● blu/blue	x1	10	425	140	355	0,674	mc. 0,004

18 genesis - struttura braccioli in plastica

genesis - plastic arms structure

code	finishing	q.kit	q.pack	a	b	c	kg.x1	vol.x1
131703-100	● nero/black	x1	5	620	345	365	1,00	mc. 0,0183
131705-100	● bianco/white	x1	5	620	345	365	1,00	mc. 0,0183
131704-100	● grigio/grey	x1	5	620	345	365	1,00	mc. 0,0183
131715-100	● blu/blue	x1	5	620	345	365	1,00	mc. 0,0183

03 genesis - sedile in plastica colorato a vista

genesis - plastic seat coloured at sight

code	finishing	q.kit	q.pack	a	b	c	kg.x1	vol.x1
132203-091	● nero/black	x1	10	460	500	55	0,95	mc. 0,017
132205-091	● bianco/white	x1	10	460	500	55	0,95	mc. 0,017
132204-091	● grigio/grey	x1	10	460	500	55	0,95	mc. 0,017
132215-091	● blu/blue	x1	10	460	500	55	0,95	mc. 0,017

26 genesis - sottosedile in plastica per telaio girevole e panca

genesis - outer plastic seat for swivel and bench

code	finishing	q.kit	q.pack	a	b	c	kg.x1	vol.x1
132203-094	● nero/black	x1	10	505	495	50	0,62	mc. 0,017
132205-094	● bianco/white	x1	10	505	495	50	0,62	mc. 0,017
132204-094	● grigio/grey	x1	10	505	495	50	0,62	mc. 0,017
132215-094	● blu/blue	x1	10	505	495	50	0,62	mc. 0,017

27 genesis - coppia tappi per versione con braccioli per girevole e panca + viti

genesis - pair of plastic caps for version with armrests for swivel and bench + screws

code	finishing	q.kit	q.pack	kg.x1
131703-103	● nero/black	x1	10	0,04
131705-103	● bianco/white	x1	10	0,04
131704-103	● grigio/grey	x1	10	0,04
131715-103	● blu/blue	x1	10	0,04

genesis

swivel/backrest options

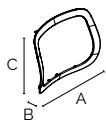
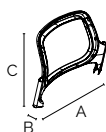

15 genesis - telaio schienale in plastica portante genesis - outer back frame in plastic

code	finishing	q.kit	q.pack	a	b	c	kg.x1	vol.x1
132103-101	● nero/black	x1	10	530	220	405	0,75	mc. 0.017
132105-101	● bianco/white	x1	10	530	220	405	0,75	mc. 0.017
132104-101	● grigio/grey	x1	10	530	220	405	0,75	mc. 0.017
132115-101	● blu/blue	x1	10	530	220	405	0,75	mc. 0.017

16 genesis - cornice schienale in plastica per rete genesis - open frame in plastic for mesh

code	finishing	q.kit	q.pack	a	b	c	kg.x1	vol.x1
132103-103	● nero/black	x1	10	425	140	355	0,30	mc. 0.004
132105-103	● bianco/white	x1	10	425	140	355	0,30	mc. 0.004
132104-103	● grigio/grey	x1	10	425	140	355	0,30	mc. 0.004
132115-103	● blu/blue	x1	10	425	140	355	0,30	mc. 0.004

and 18

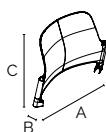

02 genesis - schienale in plastica colorato a vista genesis - plastic back coloured at sight

code	finishing	q.kit	q.pack	a	b	c	kg.x1	vol.x1
132103-100	● nero/black	x1	10	530	205	395	1,05	mc. 0.017
132105-100	● bianco/white	x1	10	530	205	395	1,05	mc. 0.017
132104-100	● grigio/grey	x1	10	530	205	395	1,05	mc. 0.017
132115-100	● blu/blue	x1	10	530	205	395	1,05	mc. 0.017

swivel/kit components

without armrests

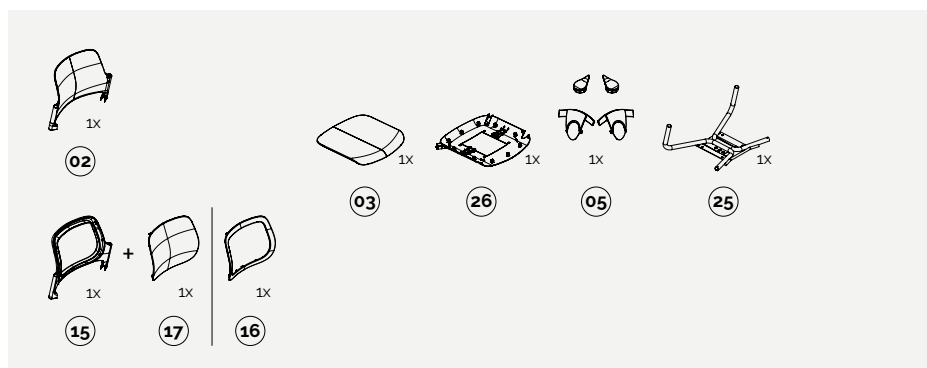
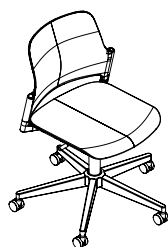

with armrests

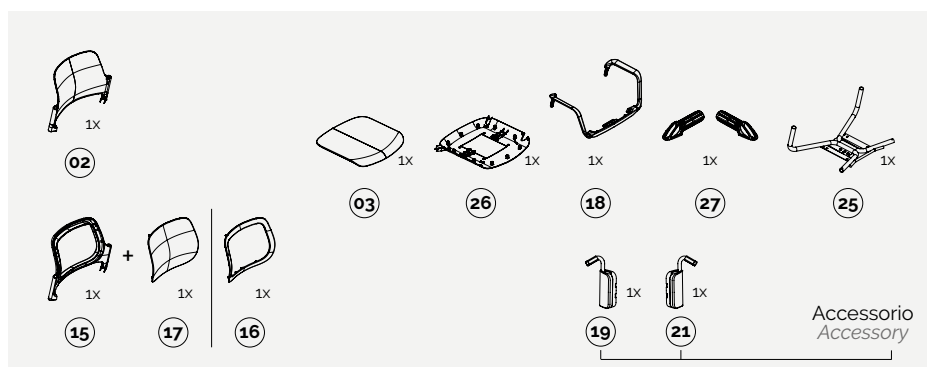
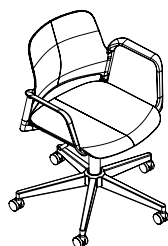

Accessorio
Accessory

genesis

bench

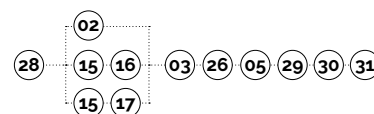

plastic colours

- nero/black
- bianco/white
- grigio/grey
- blu/blue

main component sizes

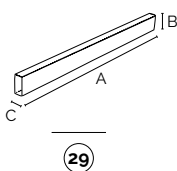
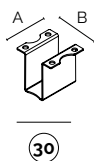
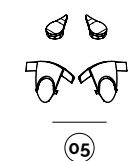
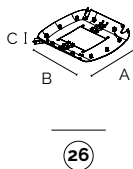
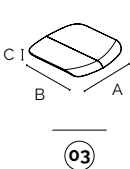
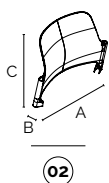
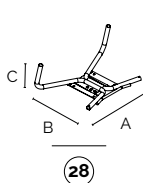

28 genesis - telaio panca genesis - bench frame

code	finishing	q.kit	q.pack	a	b	c	kg.x1	vol.x1
110703-607	● nero/black	x1	120	525	350	200	2,55	mc. 0.00704

02 genesis - schienale in plastica colorato a vista genesis - plastic back coloured at sight

code	finishing	q.kit	q.pack	a	b	c	kg.x1	vol.x1
132103-100	● nero/black	x1	10	530	205	395	1,05	mc. 0.017
132105-100	● bianco/white	x1	10	530	205	395	1,05	mc. 0.017
132104-100	● grigio/grey	x1	10	530	205	395	1,05	mc. 0.017
132115-100	● blu/blue	x1	10	530	205	395	1,05	mc. 0.017

03 genesis - sedile in plastica colorato a vista genesis - plastic seat coloured at sight

code	finishing	q.kit	q.pack	a	b	c	kg.x1	vol.x1
132203-091	● nero/black	x1	10	460	500	55	0,95	mc. 0.017
132205-091	● bianco/white	x1	10	460	500	55	0,95	mc. 0.017
132204-091	● grigio/grey	x1	10	460	500	55	0,95	mc. 0.017
132215-091	● blu/blue	x1	10	460	500	55	0,95	mc. 0.017

26 genesis - sottosedile in plastica per telaio girevole e panca genesis - outer plastic seat for swivel and bench

code	finishing	q.kit	q.pack	a	b	c	kg.x1	vol.x1
132203-094	● nero/black	x1	10	505	495	50	0,62	mc. 0.017
132205-094	● bianco/white	x1	10	505	495	50	0,62	mc. 0.017
132204-094	● grigio/grey	x1	10	505	495	50	0,62	mc. 0.017
132215-094	● blu/blue	x1	10	505	495	50	0,62	mc. 0.017

05 genesis - tappi schienale senza braccioli + coppia accessori per sedile senza braccioli genesis - caps for back without arms + pair of accessories for seat without arms

code	finishing	q.kit	q.pack	kg.x1
131703-104	● nero/black	x1	10	0,015
131705-104	● bianco/white	x1	10	0,015
131704-104	● grigio/grey	x1	10	0,015
131715-104	● blu/blue	x1	10	0,015

29 genesis - 90T(3) trave per panca 80x40 genesis - 90T(3) beam for bench 80x40

code	finishing	q.kit	q.pack	a	b	c	kg.x1	vol.x1	
110703-190	● nero/black	2 posti / 2 seats	x1	1	1160	80	40	3,20	mc. 0.0045
110704-190	● grigio/grey	2 posti / 2 seats	x1	1	1160	80	40	3,20	mc. 0.0045
110703-191	● nero/black	3 posti / 3 seats	x1	1	1710	80	40	4,71	mc. 0.005
110704-191	● grigio/grey	3 posti / 3 seats	x1	1	1710	80	40	4,71	mc. 0.005
110703-192	● nero/black	4 posti / 4 seats	x1	1	2260	80	40	6,22	mc. 0.0085
110704-192	● grigio/grey	4 posti / 4 seats	x1	1	2260	80	40	6,22	mc. 0.0085
110703-193	● nero/black	5 posti / 5 seats	x1	1	2800	80	40	7,72	mc. 0.01
110704-197	● grigio/grey	5 posti / 5 seats	x1	1	2800	80	40	7,72	mc. 0.01

30 genesis - cavalletto sotto trave genesis - under beam support

code	finishing	q.kit	q.pack	a	b	kg.x1	vol.x1
110703-007	● nero/black	x1	50	55	65	0,60	mc. 0.0005

31 genesis - confezione viti M8x12 a testa cilindrica e esagono incassato genesis - M8x12 hexagon socket head screws set

code	finishing	q.kit	q.pack
117003-070	● nero/black	x1	200

for the bench components, see page 417

genesis

bench/backrest options

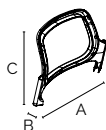

15 genesis - telaio schienale in plastica portante genesis - outer back frame in plastic

code	finishing	q.kit	q.pack	a	b	c	kg.x1	vol.x1
132103-101	● nero/black	x1	10	530	220	405	0,75	mc. 0,017
132105-101	● bianco/white	x1	10	530	220	405	0,75	mc. 0,017
132104-101	● grigio/grey	x1	10	530	220	405	0,75	mc. 0,017
132115-101	● blu/blue	x1	10	530	220	405	0,75	mc. 0,017

16 genesis - cornice schienale in plastica per rete genesis - open frame in plastic for mesh

code	finishing	q.kit	q.pack	a	b	c	kg.x1	vol.x1
132103-103	● nero/black	x1	10	425	140	355	0,30	mc. 0,004
132105-103	● bianco/white	x1	10	425	140	355	0,30	mc. 0,004
132104-103	● grigio/grey	x1	10	425	140	355	0,30	mc. 0,004
132115-103	● blu/blue	x1	10	425	140	355	0,30	mc. 0,004

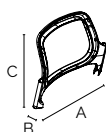

15 genesis - telaio schienale in plastica portante genesis - outer back frame in plastic

code	finishing	q.kit	q.pack	a	b	c	kg.x1	vol.x1
132103-101	● nero/black	x1	10	530	220	405	0,75	mc. 0,017
132105-101	● bianco/white	x1	10	530	220	405	0,75	mc. 0,017
132104-101	● grigio/grey	x1	10	530	220	405	0,75	mc. 0,017
132115-101	● blu/blue	x1	10	530	220	405	0,75	mc. 0,017

17 genesis - pannello in plastica schienale da tappezzare genesis - plastic panel back for upholstery

code	finishing	q.kit	q.pack	a	b	c	kg.x1	vol.x1
132103-102	● nero/black	x1	10	425	140	355	0,674	mc. 0,004
132105-102	● bianco/white	x1	10	425	140	355	0,674	mc. 0,004
132104-102	● grigio/grey	x1	10	425	140	355	0,674	mc. 0,004
132115-102	● blu/blue	x1	10	425	140	355	0,674	mc. 0,004

bench/kit components

without armrests

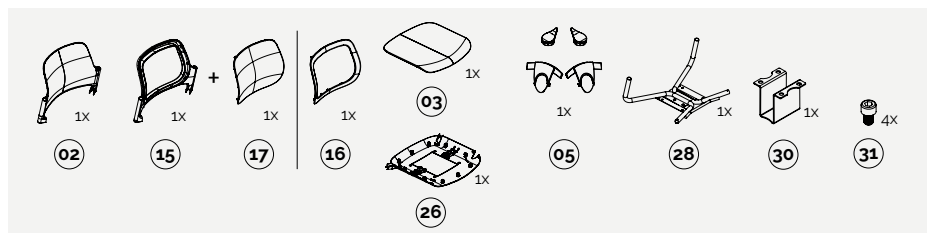
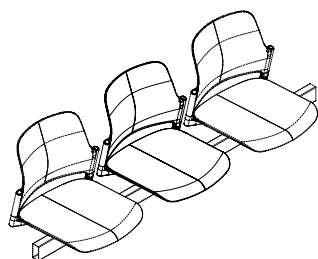

with armrests

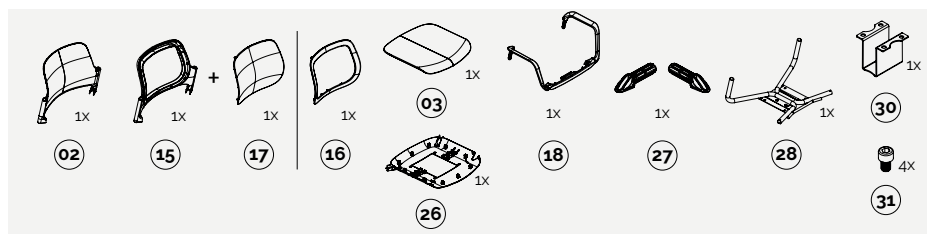
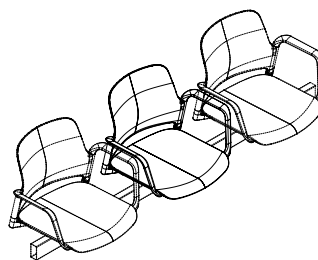

bench/leg options

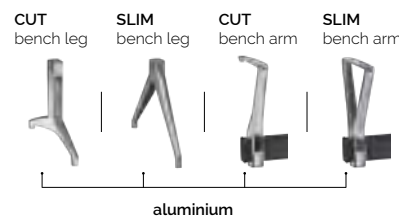

optionals



gemma



discover more about
Gemma Collection

Caratterizzata da linee essenziali e decise, Gemma è una sedia con monoscocca in tecnopolimero proposta per ambienti contract ma anche domestici.

La monoscocca poggia su un'ampia selezione di telai e basi che conferiscono alla collezione una grande dinamicità di impiego, dalle aree d'attesa, a quelle office e di coworking, fino a contesti didattici e di home office.

Characterised by its essential and decisive lines, Gemma is a chair with a technopolymer monoshell proposed for both contract and domestic environments.

The monoshell rests on a wide selection of frames and bases that give the collection great dynamism of use, from waiting areas, to office and coworking spaces, to educational and home office contexts.

Plus

• Monoscocca disponibile in plastica riciclata post-consumo.

- Adatta all'utilizzo in ambienti esterni.
- Alta impilabilità.
- Certificazione EN 16139:2013+AC2013 Livello 1.

• Monoshell available in post-consumer recycled plastic.

- Suitable for outdoor use.
- High stackability.
- EN 16139:2013+AC2013 Level 1 Certification.



designed by:
Stefano Bettio



**recycled
plastic**



**certified
product**



**outdoor
ready**



**UV plastic
protection**



**trolley
available**

gemma

4-legs

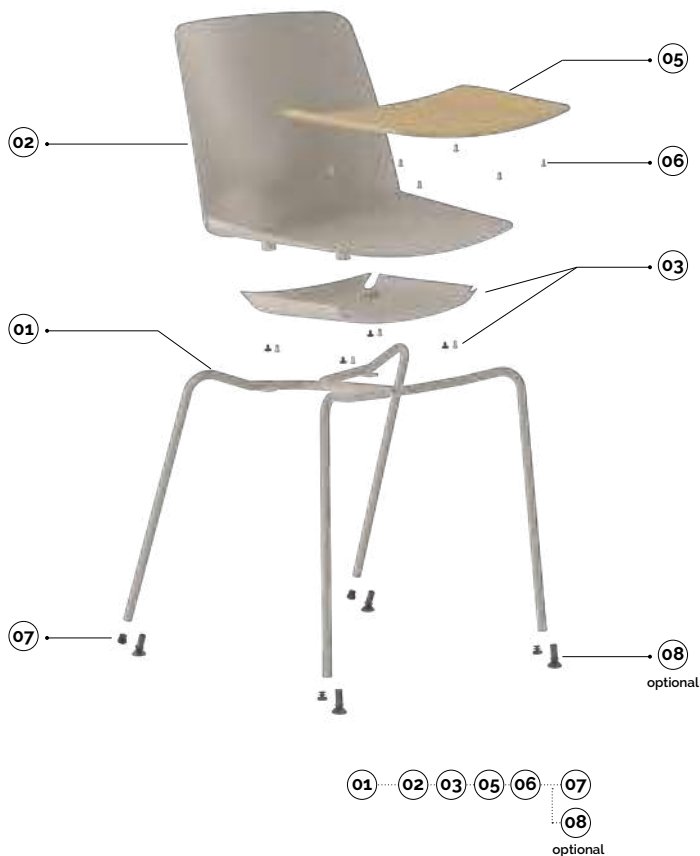
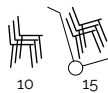

plastic colours

- nero/black
- avorio/ivory
- grigio/grey
- giallo/yellow
- verde/green
- rosso/red

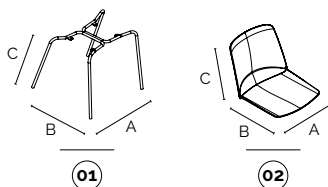

main component sizes

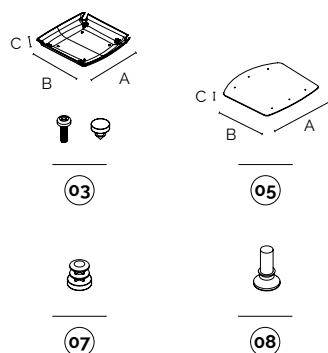

01 gemma - telaio a 4 gambe - ø16 senza tappi gemma - 4-legs frame - ø16 without caps

code	finishing	q.kit	q.pack	a	b	c	kg.x1	vol.x1
110103-527	● nero/black	x1	200	520	535	440	2,15	mc. 0,02
110105-527	● avorio/ivory	x1	200	520	535	440	2,15	mc. 0,02
110104-527	● grigio/grey	x1	200	520	535	440	2,15	mc. 0,02
110108-527	● giallo/yellow	x1	200	520	535	440	2,15	mc. 0,02
110116-527	● verde/green	x1	200	520	535	440	2,15	mc. 0,02
110102-527	● rosso/red	x1	200	520	535	440	2,15	mc. 0,02
110110-527	● cromato/chrome	x1	200	520	535	440	2,15	mc. 0,02

02 gemma - scocca in tecnopolimero anti-UV gemma - anti-UV technopolymer shell

code	finishing	q.kit	q.pack	a	b	c	kg.x1	vol.x1
133903-062	● nero/black - riciclato/recycled	x1	10	450	520	395	2,22	mc. 0,0193
133905-062	● avorio/ivory	x1	10	450	520	395	2,22	mc. 0,0193
133904-062	● grigio/grey	x1	10	450	520	395	2,22	mc. 0,0193
133908-062	● giallo/yellow	x1	10	450	520	395	2,22	mc. 0,0193
133916-062	● verde/green	x1	10	450	520	395	2,22	mc. 0,0193
133902-062	● rosso/red	x1	10	450	520	395	2,22	mc. 0,0193

03 gemma - cover in plastica sotto scocca anti-UV + viti + paracolpi gemma - anti-UV technopolymer undershell cover + screws + spacers

code	finishing	q.kit	q.pack	a	b	c	kg.x1	vol.x1
132203-093	● nero/black - riciclato/recycled	x1	20	302	323	50	0,29	mc. 0,0017
132205-093	● avorio/ivory	x1	20	302	323	50	0,29	mc. 0,0017
132204-093	● grigio/grey	x1	20	302	323	50	0,29	mc. 0,0017
132208-093	● giallo/yellow	x1	20	302	323	50	0,29	mc. 0,0017
132216-093	● verde/green	x1	20	302	323	50	0,29	mc. 0,0017
132202-093	● rosso/red	x1	20	302	323	50	0,29	mc. 0,0017

05 gemma - pannello sedile in multistrato con 6 borchie gemma - seat panel with 6 upholstery nails

code	finishing	q.kit	q.pack	a	b	c	kg.x1	vol.x1
122207-028	● faggio/plywood	x1	20	415	395	6,5	1	mc. 0,001

06 gemma - viti per il fissaggio del pannello gemma - screws for panel fixing

code	finishing	q.kit	q.pack
117011-080	● zincata/zinc	x6	120

07 gemma - tappo alettato tondo - ø16 gemma - inner cap for legs - ø16

code	finishing	q.kit
134203-160	● nero/black	x4

08 gemma - piedino ad inclinazione variabile in plastica ø16 gemma - plastic orientable glide ø16

code	finishing	q.kit
134203-163	● nero/black	x4

30 gemma - carrello porta sedie con accessori gemma - chair trolley with accessories

code	finishing	q.kit
110803-447	● nero/black	x1

gemma

4-legs w/armrests

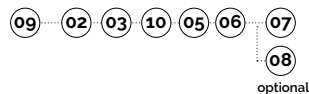
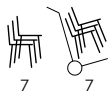

plastic colours

- nero/black
- avorio/ivory
- grigio/grey
- giallo/yellow
- verde/green
- rosso/red

09 gemma - telaio a 4 gambe con braccioni - ø16 senza tappi
gemma - 4-legs frame with armrests - ø16 without caps

code	finishing	q.kit	q.pack	a	b	c	d	kg.x1	vol.x1
110103-536	● nero/black	x1	60	495	555	440	670	2,95	mc. 0.035
110105-536	● avorio/ivory	x1	60	495	555	440	670	2,95	mc. 0.035
110104-536	● grigio/grey	x1	60	495	555	440	670	2,95	mc. 0.035
110110-536	● cromato/chrome	x1	60	495	555	440	670	2,95	mc. 0.035

● ● ● colori disponibili solo in quantità minima d'ordine
colour only available in minimum order quantities

02 gemma - scocca in tecnopolimero anti-UV
gemma - anti-UV technopolymer shell

code	finishing	q.kit	q.pack	a	b	c	kg.x1	vol.x1
133903-062	● nero/black - riciclato/recycled	x1	10	450	520	395	2,22	mc. 0.0193
133905-062	● avorio/ivory	x1	10	450	520	395	2,22	mc. 0.0193
133904-062	● grigio/grey	x1	10	450	520	395	2,22	mc. 0.0193
133908-062	● giallo/yellow	x1	10	450	520	395	2,22	mc. 0.0193
133916-062	● verde/green	x1	10	450	520	395	2,22	mc. 0.0193
133902-062	● rosso/red	x1	10	450	520	395	2,22	mc. 0.0193

03 gemma - cover in plastica sotto scocca anti-UV + viti + paracolpi
gemma - anti-UV technopolymer undershell cover + screws + spacers

code	finishing	q.kit	q.pack	a	b	c	kg.x1	vol.x1
132203-093	● nero/black - riciclato/recycled	x1	20	302	323	50	0,29	mc. 0.0017
132205-093	● avorio/ivory	x1	20	302	323	50	0,29	mc. 0.0017
132204-093	● grigio/grey	x1	20	302	323	50	0,29	mc. 0.0017
132208-093	● giallo/yellow	x1	20	302	323	50	0,29	mc. 0.0017
132216-093	● verde/green	x1	20	302	323	50	0,29	mc. 0.0017
132202-093	● rosso/red	x1	20	302	323	50	0,29	mc. 0.0017

10 gemma - coppia di braccioni in tecnopolimero anti-UV + viti
gemma - pair of anti-UV technopolymer armrests + screws

code	finishing	q.kit	q.pack	a	b	c	kg.x1
131703-076	● nero/black - riciclato/recycled	x1	20	165	50	25	0,075
131705-076	● avorio/ivory	x1	20	165	50	25	0,075
131704-076	● grigio/grey	x1	20	165	50	25	0,075
131708-076	● giallo/yellow	x1	20	165	50	25	0,075
131716-076	● verde/green	x1	20	165	50	25	0,075
131702-076	● rosso/red	x1	20	165	50	25	0,075

main component sizes

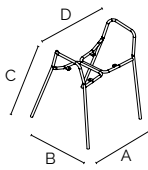

09

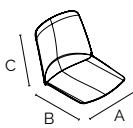

02

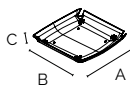

03

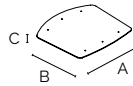

05

07

08

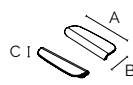

10

for the components below, see the previous pages

05 06 07 08

gemma

4-legs w/writing tablet

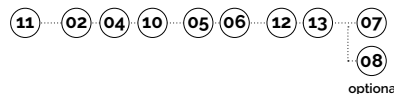
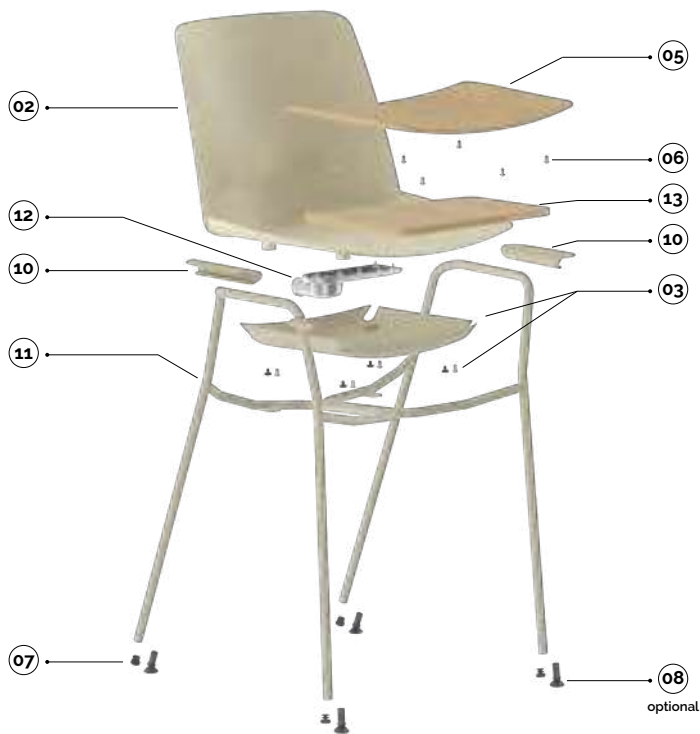
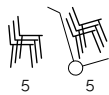

plastic colours

- nero/black
- avorio/ivory
- grigio/grey
- giallo/yellow
- verde/green
- rosso/red

main component sizes

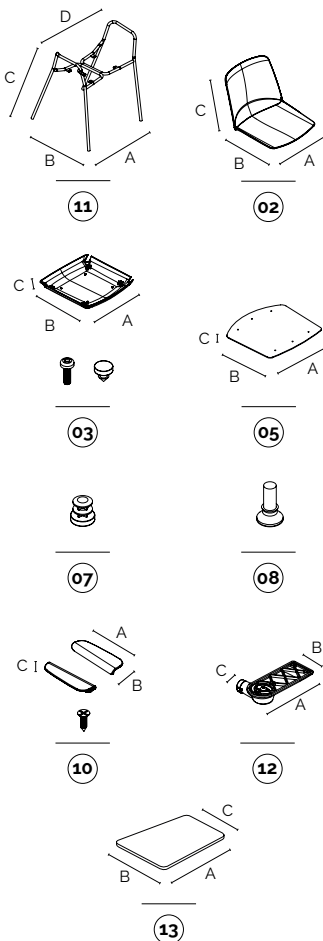

11 gemma - telaio a 4 gambe con braccioli e aggancio porta tavoletta - ø16 senza tappi
gemma - 4-legs frame with armrests and tablet holder attachment - ø16 without caps

code	finishing	q.kit	q.pack	a	b	c	d	kg.x1	vol.x1
110103-577	● nero/black	x1	50	495	555	440	670	3.04	mc. 0.035
110105-577	● avorio/ivory	x1	50	495	555	440	670	3.04	mc. 0.035
110104-577	● grigio/grey	x1	50	495	555	440	670	3.04	mc. 0.035
110110-577	● cromato/chrome	x1	50	495	555	440	670	3.04	mc. 0.035

● ● ● colori disponibili solo in quantità minima d'ordine
colour only available in minimum order quantities

02 gemma - scocca in tecnopolimero anti-UV
gemma - anti-UV technopolymer shell

code	finishing	q.kit	q.pack	a	b	c	kg.x1	vol.x1
133903-062	● nero/black - riciclato/recycled	x1	10	450	520	395	2.22	mc. 0.0193
133905-062	● avorio/ivory	x1	10	450	520	395	2.22	mc. 0.0193
133904-062	● grigio/grey	x1	10	450	520	395	2.22	mc. 0.0193
133908-062	● giallo./yellow	x1	10	450	520	395	2.22	mc. 0.0193
133916-062	● verde/green	x1	10	450	520	395	2.22	mc. 0.0193
133902-062	● rosso/red	x1	10	450	520	395	2.22	mc. 0.0193

03 gemma - cover in plastica sotto scocca anti-UV + viti + paracolpi
gemma - anti-UV technopolymer undershell cover + screws + spacers

code	finishing	q.kit	q.pack	a	b	c	kg.x1	vol.x1
132203-093	● nero/black - riciclato/recycled	x1	20	302	323	50	0.29	mc. 0.0017
132205-093	● avorio/ivory	x1	20	302	323	50	0.29	mc. 0.0017
132204-093	● grigio/grey	x1	20	302	323	50	0.29	mc. 0.0017
132208-093	● giallo./yellow	x1	20	302	323	50	0.29	mc. 0.0017
132216-093	● verde/green	x1	20	302	323	50	0.29	mc. 0.0017
132202-093	● rosso/red	x1	20	302	323	50	0.29	mc. 0.0017

12 gemma - snodo antipatico SPTA per fissaggio tavoletta
gemma - SPTA safety joint for tablet attachment

code	finishing	q.kit	q.pack	a	b	c	kg.x1	vol.x1
111701-900	● alluminio/aluminium destra/right	x1	10	180	66	15x15	0.365	mc. 0.001
111701-901	● alluminio/aluminium sinistra/left	x1	10	180	66	15x15	0.365	mc. 0.001

13 gemma - tavoletta in legno TL02 con prefidi
gemma - TL02 wooden tablet with prefolds

code	finishing	q.kit	q.pack	a	b	c	kg.x1	vol.x1
120307-021	● faggio/plywood destra/right	x1	10	342	245	196	0.65	mc. 0.009
120307-022	● faggio/plywood sinistra/left	x1	10	342	245	196	0.65	mc. 0.009

for the components below, see the previous pages



gemma

4-legs conference

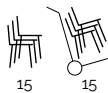

plastic colours

- nero/black
- avorio/ivory
- grigio/grey
- giallo/yellow
- verde/green
- rosso/red

main component sizes

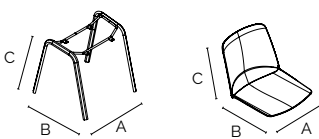

14

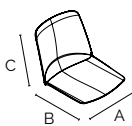

02

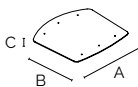

05



15



16



31 gemma - carrello porta sedie con accessori per versione conference
gemma - chair trolley with accessories for conference version

code	finishing	q.kit
110803-465	● nero/black	x1

14 gemma - telaio a 4 gambe conference - senza tappi
gemma - 4-legs conference frame - without caps

code	finishing	q.kit	q.pack	a	b	c	kg.x1	vol.x1
110103-540	● nero/black	x1	80	530	485	485	2,95	/
110105-540	● avorio/ivory	x1	80	530	485	485	2,95	/
110104-540	● grigio/grey	x1	80	530	485	485	2,95	/
110108-540	● giallo/yellow	x1	80	530	485	485	2,95	/
110116-540	● verde/green	x1	80	530	485	485	2,95	/
110102-540	● rosso/red	x1	80	530	485	485	2,95	/
110110-540	● cromato/chrome	x1	80	530	485	485	2,95	/

02 gemma - scocca in tecnopolimero anti-UV
gemma - anti-UV technopolymer shell

code	finishing	q.kit	q.pack	a	b	c	kg.x1	vol.x1
133903-062	● nero/black - riciclato/recycled	x1	10	450	520	395	2,22	mc. 0,0193
133905-062	● avorio/ivory	x1	10	450	520	395	2,22	mc. 0,0193
133904-062	● grigio/grey	x1	10	450	520	395	2,22	mc. 0,0193
133908-062	● giallo/yellow	x1	10	450	520	395	2,22	mc. 0,0193
133916-062	● verde/green	x1	10	450	520	395	2,22	mc. 0,0193
133902-062	● rosso/red	x1	10	450	520	395	2,22	mc. 0,0193

04 gemma - confezione viti TC+combi 6x16 testa cilindrica a croce - per fissaggio scocca senza cover
gemma - screws set TC+combi 6x16 cylindrical cross-head - for mounting shell without cover

code	finishing	q.kit	q.pack
117011-078	● zincata/zinc	x4	40

05 gemma - pannello sedile in multistrato con 6 borchie
gemma - seat panel with 6 upholstery nails

code	finishing	q.kit	q.pack	a	b	c	kg.x1	vol.x1
122207-028	● faggio/plywood	x1	20	415	395	6,5	1	mc. 0,001

06 gemma - viti per il fissaggio del pannello
gemma - screws for panel fixing

code	finishing	q.kit	q.pack
117011-080	● zincata/zinc	x6	120

15 gemma - piedino ovale per gamba per telaio conference - 30x15
gemma - oval leg glide for conference frame - 30x15

code	finishing	q.kit
130303-024	● nero/black	x4

16 gemma - paracolpi testa piastra PF3 per telai conference
gemma - PF3 flat head spacers for conference frames

code	finishing	q.kit
134006-102	● neutro/neutral	x4

gemma

4-legs conference with hooks

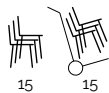

plastic colours

- nero/black
- avorio/ivory
- grigio/grey
- giallo/yellow
- verde/green
- rosso/red

main component sizes

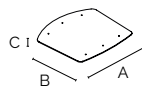
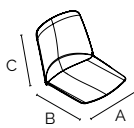
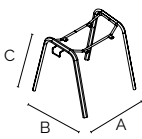

17 gemma - telaio a 4 gambe conference con ganci - senza tappi
gemma - 4-legs conference frame with hooks - without caps

code	finishing	q.kit	q.pack	a	b	c	kg.x1	vol.x1
110103-541	● nero/black	x1	80	530	485	485	3,00	/
110105-541	● avorio/ivory	x1	80	530	485	485	3,00	/
110104-541	● grigio/grey	x1	80	530	485	485	3,00	/
110110-541	● cromato/chrome	x1	80	530	485	485	3,00	/

● ● ● colori disponibili solo in quantità minima d'ordine
colour only available in minimum order quantities

02 gemma - scocca in tecnopolimero anti-UV
gemma - anti-UV technopolymer shell

code	finishing	q.kit	q.pack	a	b	c	kg.x1	vol.x1
133903-062	● nero/black - riciclato/recycled	x1	10	450	520	395	2,22	mc. 0,0193
133905-062	● avorio/ivory	x1	10	450	520	395	2,22	mc. 0,0193
133904-062	● grigio/grey	x1	10	450	520	395	2,22	mc. 0,0193
133908-062	● giallo/yellow	x1	10	450	520	395	2,22	mc. 0,0193
133916-062	● verde/green	x1	10	450	520	395	2,22	mc. 0,0193
133902-062	● rosso/red	x1	10	450	520	395	2,22	mc. 0,0193

04 gemma - confezione viti TC+combi 6x16 testa cilindrica a croce - per fissaggio scocca senza cover
gemma - screws set TC+combi 6x16 cylindrical cross-head - for mounting shell without cover

code	finishing	q.kit	q.pack
117011-078	● zincata/zinc	x4	40

05 gemma - pannello sedile in multistrato con 6 borchie
gemma - seat panel with 6 upholstery nails

code	finishing	q.kit	q.pack	a	b	c	kg.x1	vol.x1
122207-028	● faggio/plywood	x1	20	415	395	6,5	1	mc. 0,001

06 gemma - viti per il fissaggio del pannello
gemma - screws for panel fixing

code	finishing	q.kit	q.pack
117011-080	● zincata/zinc	x6	120

15 gemma - piedino ovale per gamba per telaio conference - 30x15
gemma - oval leg glide for conference frame - 30x15

code	finishing	q.kit
130303-024	● nero/black	x4

16 gemma - paracolpi testa piatta PF3 per telai conference
gemma - PF3 flat head spacers for conference frames

code	finishing	q.kit
134006-102	● neutro/neutral	x4

gemma

sled

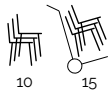

plastic colours

- nero/black
- avorio/ivory
- grigio/grey
- giallo/yellow
- verde/green
- rosso/red

main component sizes

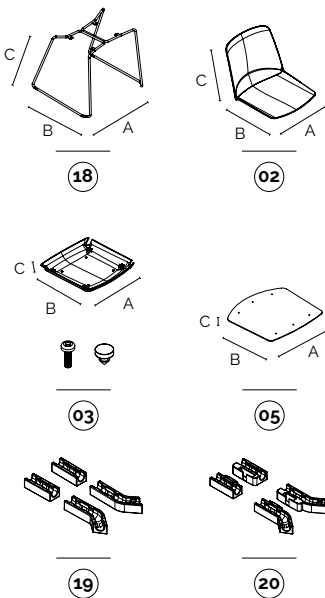

18 gemma - telaio a slitta in tondino - ø12 gemma - sled frame - ø12

code	finishing	q.kit	q.pack	a	b	c	kg.x1	vol.x1
113403-452	● nero/black	x1	100	575	525	480	3,95	mc. 0.03
113405-452	● avorio/ivory	x1	100	575	525	480	3,95	mc. 0.03
113404-452	● grigio/grey	x1	100	575	525	480	3,95	mc. 0.03
113408-452	● giallo/yellow	x1	100	575	525	480	3,95	mc. 0.03
113416-452	● verde/green	x1	100	575	525	480	3,95	mc. 0.03
113402-452	● rosso/red	x1	100	575	525	480	3,95	mc. 0.03
113410-452	● cromato/chrome	x1	100	575	525	480	3,95	mc. 0.03

02 gemma - scocca in tecnopolimero anti-UV gemma - anti-UV technopolymer shell

code	finishing	q.kit	q.pack	a	b	c	kg.x1	vol.x1
133903-062	● nero/black - riciclato/recycled	x1	10	450	520	395	2,22	mc. 0.0193
133905-062	● avorio/ivory	x1	10	450	520	395	2,22	mc. 0.0193
133904-062	● grigio/grey	x1	10	450	520	395	2,22	mc. 0.0193
133908-062	● giallo/yellow	x1	10	450	520	395	2,22	mc. 0.0193
133916-062	● verde/green	x1	10	450	520	395	2,22	mc. 0.0193
133902-062	● rosso/red	x1	10	450	520	395	2,22	mc. 0.0193

03 gemma - cover in plastica sotto scocca anti-UV + viti + paracolpi gemma - anti-UV technopolymer undershell cover + screws + spacers

code	finishing	q.kit	q.pack	a	b	c	kg.x1	vol.x1
132203-093	● nero/black - riciclato/recycled	x1	20	302	323	50	0,29	mc. 0.0017
132205-093	● avorio/ivory	x1	20	302	323	50	0,29	mc. 0.0017
132204-093	● grigio/grey	x1	20	302	323	50	0,29	mc. 0.0017
132208-093	● giallo/yellow	x1	20	302	323	50	0,29	mc. 0.0017
132216-093	● verde/green	x1	20	302	323	50	0,29	mc. 0.0017
132202-093	● rosso/red	x1	20	302	323	50	0,29	mc. 0.0017

05 gemma - pannello sedile in multistrato con 6 borchie gemma - seat panel with 6 upholstery nails

code	finishing	q.kit	q.pack	a	b	c	kg.x1	vol.x1
122207-028	● faggio/plywood	x1	20	415	395	6,5	1	mc. 0.001

06 gemma - viti per il fissaggio del pannello gemma - screws for panel fixing

code	finishing	q.kit	q.pack
117011-080	● zincata/zinc	x6	120

19 gemma - kit piedini BTF gemma - BTF glides kit

code	finishing	q.kit	q.pack
134306-001	● neutro/neutral	x1	100

20 gemma - kit piedini con ganci BTFA gemma - BTFA hooked glides kit

code	finishing	q.kit	q.pack
134306-002	● neutro/neutral	x1	100

gemma

4-spoke base



21 02 04 05 06 22

plastic colours

- nero/black
- avorio/ivory
- grigio/grey
- giallo/yellow
- verde/green
- rosso/red

21 gemma - base fissa a 4 razze per ruote con riduttori

gemma - 4-spoke fixed base with adapter for castors

code	finishing	q.kit	q.pack	a	b	c	kg.x1	vol.x1
110903-293	● nero/black	x1	30	660	475	380	3,45	mc. 0.10
110905-293	● avorio/ivory	x1	30	660	475	380	3,45	mc. 0.10
110904-293	● grigio/grey	x1	30	660	475	380	3,45	mc. 0.10
110910-293	● cromato/chrome	x1	30	660	475	380	3,45	mc. 0.10

● ● ● colori disponibili solo in quantità minima d'ordine
colour only available in minimum order quantities

02 gemma - scocca in tecnopolimero anti-UV

gemma - anti-UV technopolymer shell

code	finishing	q.kit	q.pack	a	b	c	kg.x1	vol.x1
133903-062	● nero/black - riciclato/recycled	x1	10	450	520	395	2,22	mc. 0.0193
133905-062	● avorio/ivory	x1	10	450	520	395	2,22	mc. 0.0193
133904-062	● grigio/grey	x1	10	450	520	395	2,22	mc. 0.0193
133908-062	● giallo/yellow	x1	10	450	520	395	2,22	mc. 0.0193
133916-062	● verde/green	x1	10	450	520	395	2,22	mc. 0.0193
133902-062	● rosso/red	x1	10	450	520	395	2,22	mc. 0.0193

04 gemma - confezione viti TC+combi 6x16 testa cilindrica a croce - per fissaggio scocca senza cover

gemma - screws set TC+combi 6x16 cylindrical cross-head - for mounting shell without cover

code	finishing	q.kit	q.pack
117011-078	● zincata/zinc	x4	40

05 gemma - pannello sedile in multistrato con 6 borchie

gemma - seat panel with 6 upholstery nails

code	finishing	q.kit	q.pack	a	b	c	kg.x1	vol.x1
122207-028	● faggio/plywood	x1	20	415	395	6,5	1	mc. 0.001

06 gemma - viti per il fissaggio del pannello

gemma - screws for panel fixing

code	finishing	q.kit	q.pack
117011-080	● zincata/zinc	x6	120

22 gemma - doppia ruota in desmopan con perno montato - ø50

gemma - twin desmopan castor wheel with mounted pin - ø50

code	finishing	q.kit	kg.x1
134403-003	● nero/black	x4	0,05

main component sizes

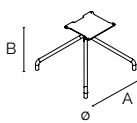

21

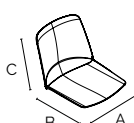

02

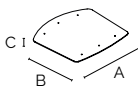

05



22

gemma

swivel base



23 02 04 05 06 24

plastic colours

- nero/black
- avorio/ivory
- grigio/grey
- giallo/yellow
- verde/green
- rosso/red

main component sizes

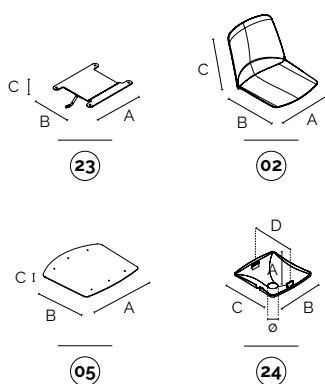

23 gemma - piastra verniciata per base girevole + spatola

gemma - painted plate for swivel base + spatula

code	finishing	q.kit	q.pack	a	b	c	kg.x1	vol.x1
110903-290	● nero/black	x1	10	258	228	75	2,30	mc. 0.004

02 gemma - scocca in tecnopolimero anti-UV

gemma - anti-UV technopolymer shell

code	finishing	q.kit	q.pack	a	b	c	kg.x1	vol.x1
133903-062	● nero/black - riciclato/recycled	x1	10	450	520	395	2,22	mc. 0.0193
133905-062	● avorio/ivory	x1	10	450	520	395	2,22	mc. 0.0193
133904-062	● grigio/grey	x1	10	450	520	395	2,22	mc. 0.0193
133908-062	● giallo./yellow	x1	10	450	520	395	2,22	mc. 0.0193
133916-062	● verde/green	x1	10	450	520	395	2,22	mc. 0.0193
133902-062	● rosso/red	x1	10	450	520	395	2,22	mc. 0.0193

04 gemma - confezione viti TC+combi 6x16 testa cilindrica a croce - per fissaggio scocca senza cover

gemma - screws set TC+combi 6x16 cylindrical cross-head - for mounting shell without cover

code	finishing	q.kit	q.pack
117011-078	● zincata/zinc	x4	40

05 gemma - pannello sedile in multistrato con 6 borchie

gemma - seat panel with 6 upholstery nails

code	finishing	q.kit	q.pack	a	b	c	kg.x1	vol.x1
122207-028	● faggio/plywood	x1	20	415	395	6,5	1	mc. 0.001

06 gemma - viti per il fissaggio del pannello

gemma - screws for panel fixing

code	finishing	q.kit	q.pack
117011-080	● zincata/zinc	x6	120

24 cpg - copertina in plastica per telaio girevole

cpg - plastic cover for swivel frame

code	finishing	q.kit	q.pack	a	b	c	d	ø	kg.x1	vol.x1
130903-000	● nero/black	x1	50	60	200	210	167	36	0.1	mc. 0.0008

gemma

low stool h.650



6

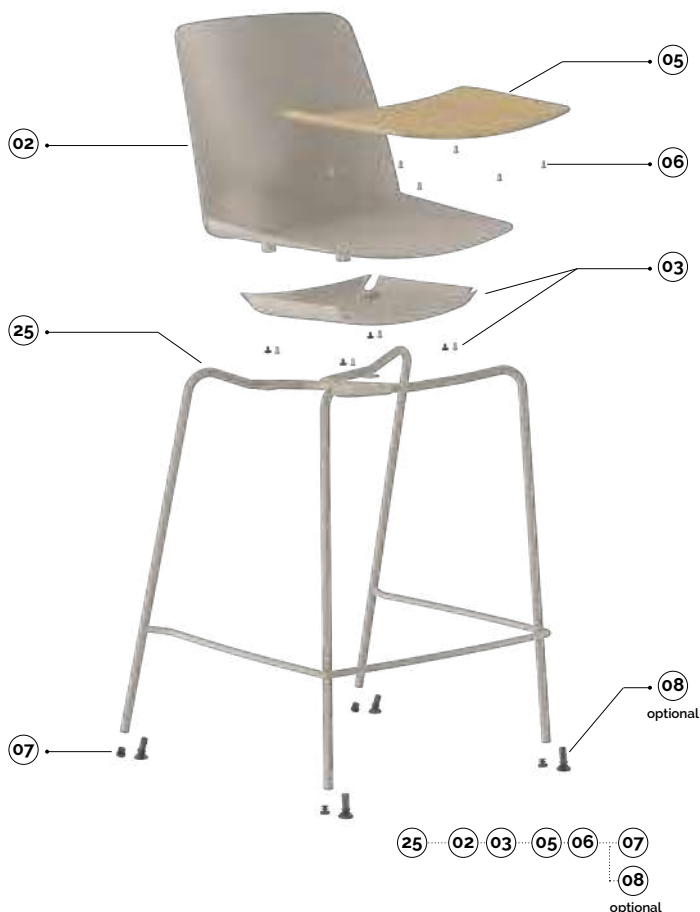

plastic colours

- nero/black
- avorio/ivory
- grigio/grey
- giallo/yellow
- verde/green
- rosso/red

main component sizes

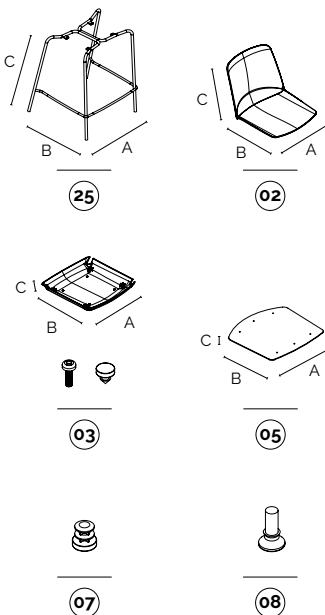

25 gemma - telaio sgabello basso - h.650 ø16 senza tappi
gemma - low stool frame - h.650 ø16 without caps

code	finishing	q.kit	q.pack	a	b	c	kg.x1	vol.x1
110603-692	● nero/black	x1	50	555	545	630	3,92	mc. 0.08
110605-692	● avorio/ivory	x1	50	555	545	630	3,92	mc. 0.08
110604-692	● grigio/grey	x1	50	555	545	630	3,92	mc. 0.08
110610-692	● cromato/chrome	x1	50	555	545	630	3,92	mc. 0.08

● ● ● colori disponibili solo in quantità minima d'ordine
colour only available in minimum order quantities

02 gemma - scocca in tecnopolimero anti-UV
gemma - anti-UV technopolymer shell

code	finishing	q.kit	q.pack	a	b	c	kg.x1	vol.x1
133903-062	● nero/black - riciclato/recycled	x1	10	450	520	395	2,22	mc. 0.0193
133905-062	● avorio/ivory	x1	10	450	520	395	2,22	mc. 0.0193
133904-062	● grigio/grey	x1	10	450	520	395	2,22	mc. 0.0193
133908-062	● giallo/yellow	x1	10	450	520	395	2,22	mc. 0.0193
133916-062	● verde/green	x1	10	450	520	395	2,22	mc. 0.0193
133902-062	● rosso/red	x1	10	450	520	395	2,22	mc. 0.0193

03 gemma - cover in plastica sotto scocca anti-UV + viti + paracolpi
gemma - anti-UV technopolymer undershell cover + screws + spacers

code	finishing	q.kit	q.pack	a	b	c	kg.x1	vol.x1
132203-093	● nero/black - riciclato/recycled	x1	20	302	323	50	0,29	mc. 0.0017
132205-093	● avorio/ivory	x1	20	302	323	50	0,29	mc. 0.0017
132204-093	● grigio/grey	x1	20	302	323	50	0,29	mc. 0.0017
132208-093	● giallo/yellow	x1	20	302	323	50	0,29	mc. 0.0017
132216-093	● verde/green	x1	20	302	323	50	0,29	mc. 0.0017
132202-093	● rosso/red	x1	20	302	323	50	0,29	mc. 0.0017

05 gemma - pannello sedile in multistrato con 6 borchie
gemma - seat panel with 6 upholstery nails

code	finishing	q.kit	q.pack	a	b	c	kg.x1	vol.x1
122207-028	● faggio/plywood	x1	20	415	395	6,5	1	mc. 0.001

06 gemma - viti per il fissaggio del pannello
gemma - screws for panel fixing

code	finishing	q.kit	q.pack
117011-080	● zincata/zinc	x6	120

07 gemma - tappo alettato tondo - ø16
gemma - inner cap for legs - ø16

code	finishing	q.kit
134203-160	● nero/black	x4

08 gemma - piedino ad inclinazione variabile in plastica ø16
gemma - plastic orientable glide ø16

code	finishing	q.kit
134203-163	● nero/black	x4

gemma

high stool h.750



6



plastic colours

- nero/black
- avorio/ivory
- grigio/grey
- giallo/yellow
- verde/green
- rosso/red

main component sizes

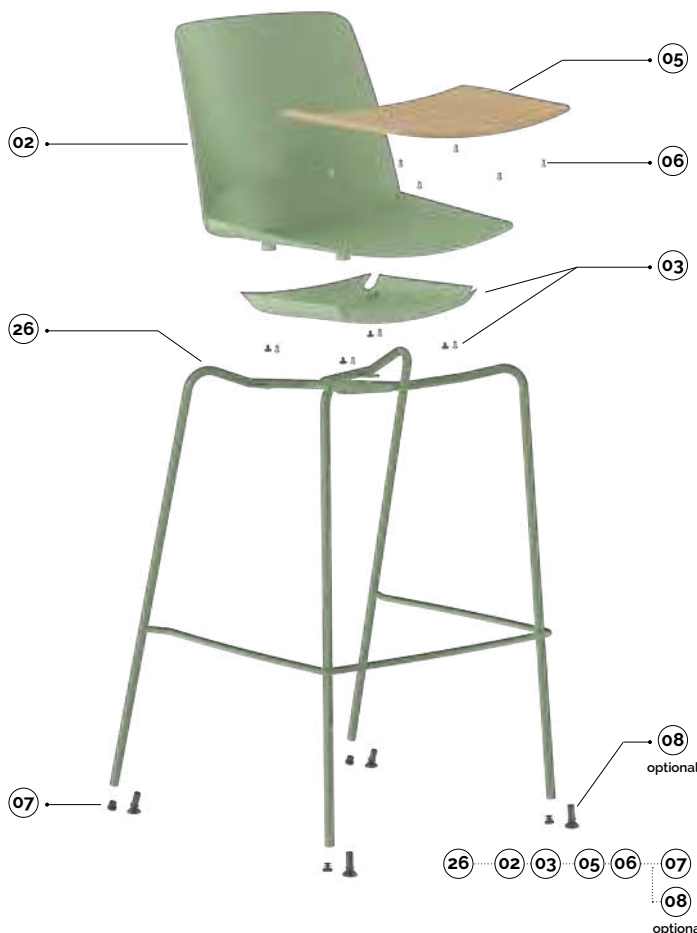
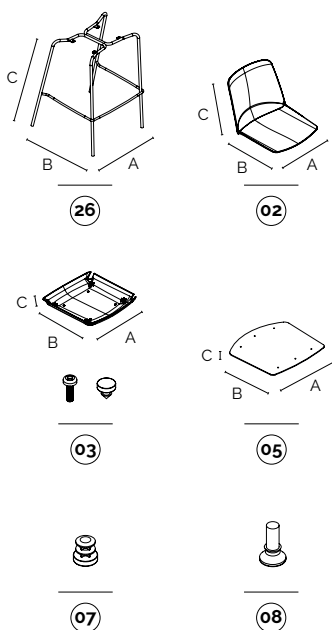

26 gemma - telaio sgabello alto - h.750 ø16 senza tappi
gemma - high stool frame - h.750 ø16 without caps

code	finishing	q.kit	q.pack	a	b	c	kg.x1	vol.x1
110603-696	● nero/black	x1	50	560	545	730	4,20	mc. 0.08
110605-696	● avorio/ivory	x1	50	560	545	730	4,20	mc. 0.08
110604-696	● grigio/grey	x1	50	560	545	730	4,20	mc. 0.08
110610-696	● cromato/chrome	x1	50	560	545	730	4,20	mc. 0.08

● ● ● colori disponibili solo in quantità minima d'ordine
colour only available in minimum order quantities

02 gemma - scocca in tecnopolimero anti-UV
gemma - anti-UV technopolymer shell

code	finishing	q.kit	q.pack	a	b	c	kg.x1	vol.x1
133903-062	● nero/black - riciclato/recycled	x1	10	450	520	395	2,22	mc. 0.0193
133905-062	● avorio/ivory	x1	10	450	520	395	2,22	mc. 0.0193
133904-062	● grigio/grey	x1	10	450	520	395	2,22	mc. 0.0193
133908-062	● giallo/yellow	x1	10	450	520	395	2,22	mc. 0.0193
133916-062	● verde/green	x1	10	450	520	395	2,22	mc. 0.0193
133902-062	● rosso/red	x1	10	450	520	395	2,22	mc. 0.0193

03 gemma - cover in plastica sotto scocca anti-UV + viti + paracolpi
gemma - anti-UV technopolymer undershell cover + screws + spacers

code	finishing	q.kit	q.pack	a	b	c	kg.x1	vol.x1
132203-093	● nero/black - riciclato/recycled	x1	20	302	323	50	0,29	mc. 0.0017
132205-093	● avorio/ivory	x1	20	302	323	50	0,29	mc. 0.0017
132204-093	● grigio/grey	x1	20	302	323	50	0,29	mc. 0.0017
132208-093	● giallo/yellow	x1	20	302	323	50	0,29	mc. 0.0017
132216-093	● verde/green	x1	20	302	323	50	0,29	mc. 0.0017
132202-093	● rosso/red	x1	20	302	323	50	0,29	mc. 0.0017

05 gemma - pannello sedile in multistrato con 6 borchie
gemma - seat panel with 6 upholstery nails

code	finishing	q.kit	q.pack	a	b	c	kg.x1	vol.x1
122207-028	● faggio/plywood	x1	20	415	395	6,5	1	mc. 0.001

06 gemma - viti per il fissaggio del pannello
gemma - screws for panel fixing

code	finishing	q.kit	q.pack
117011-080	● zincata/zinc	x6	120

07 gemma - tappo alettato tondo - ø16
gemma - inner cap for legs - ø16

code	finishing	q.kit
134203-160	● nero/black	x4

08 gemma - piedino ad inclinazione variabile in plastica ø16
gemma - plastic orientable glide ø16

code	finishing	q.kit
134203-163	● nero/black	x4

gemma

bench

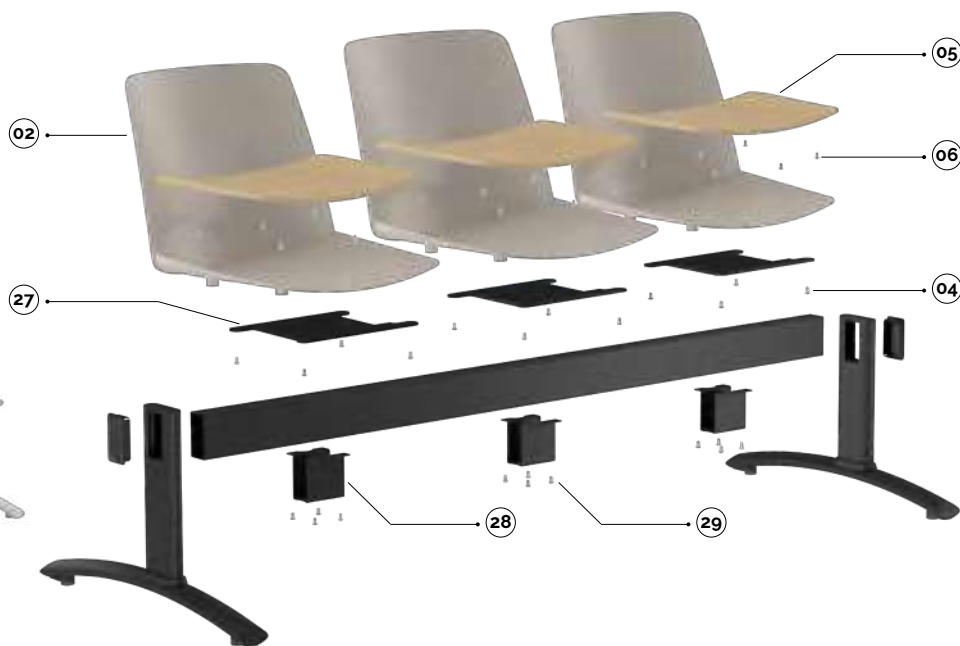

27 02 04 05 06 28 29

plastic colours

- nero/black
- avorio/ivory
- grigio/grey
- giallo/yellow
- verde/green
- rosso/red

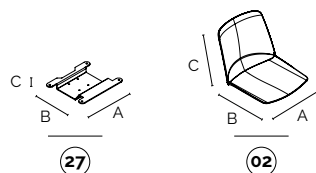

main component sizes

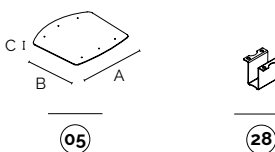

for the bench components, see page 417

27 gemma - piastra verniciata per fissaggio scocca su trave panca
gemma - painted plate for fixing shell on bench beam

code	finishing	q.kit	q.pack	a	b	c	kg.x1	vol.x1
110703-605	● nero/black	x1	10	258	231	40	1,60	mc. 0,0002

02 gemma - scocca in tecnopolimero anti-UV
gemma - anti-UV technopolymer shell

code	finishing	q.kit	q.pack	a	b	c	kg.x1	vol.x1
133903-062	● nero/black - riciclato/recycled	x1	10	450	520	395	2,22	mc. 0,0193
133905-062	● avorio/ivory	x1	10	450	520	395	2,22	mc. 0,0193
133904-062	● grigio/grey	x1	10	450	520	395	2,22	mc. 0,0193
133908-062	● giallo/yellow	x1	10	450	520	395	2,22	mc. 0,0193
133916-062	● verde/green	x1	10	450	520	395	2,22	mc. 0,0193
133902-062	● rosso/red	x1	10	450	520	395	2,22	mc. 0,0193

04 gemma - confezione viti TC+combi 6x16 testa cilindrica a croce - per fissaggio scocca senza cover
gemma - screws set TC+combi 6x16 cylindrical cross-head - for mounting shell without cover

code	finishing	q.kit	q.pack
117011-078	● zincata/zinc	x4	40

05 gemma - pannello sedile in multistrato con 6 borchie
gemma - seat panel with 6 upholstery nails

code	finishing	q.kit	q.pack	a	b	c	kg.x1	vol.x1
122207-028	● faggio/plywood	x1	20	415	395	6,5	1	mc. 0,001

06 gemma - viti per il fissaggio del pannello
gemma - screws for panel fixing

code	finishing	q.kit	q.pack
117011-080	● zincata/zinc	x6	120

28 gemma - cavalletto sotto trave
gemma - under beam support

code	finishing	q.kit	q.pack	a	b	kg.x1	vol.x1
110703-007	● nero/black	x1	50	55	65	0,60	mc. 0,0005

29 gemma - confezione viti M8x12 a testa cilindrica e esagono incassato
gemma - M8x12 hexagon socket head screws set

code	finishing	q.kit	q.pack
117003-070	● nero/black	x4	200



optionals

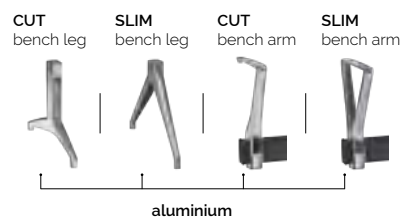
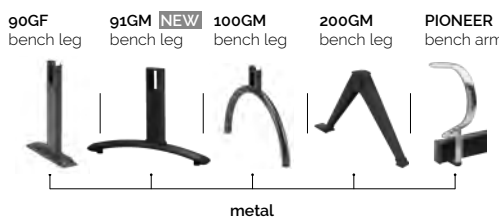





lemon



discover more about
Lemon Collection

Lemon è una completa collezione di sedute e tavoli, ideali per contesti di utilizzo outdoor, ma non solo.

La collezione è offerta in una curata selezione di colori e finiture, sia nelle versioni sedia che sgabello, sia nell'ampia gamma di tavoli e tavolini.

Lemon is a complete collection of seats and tables, ideal for outdoor use, but more than that.

The collection is offered in a refined and contemporary selection of colors and finishes, in both chair and stool versions, as well as in the wide range of tables.

Plus

- Ampia gamma di colori disponibili.
 - Sedie e sgabelli abbinabili a tavoli in diverse dimensioni e formati.
 - Certificazione EN 16139:2013+AC2013 Livello 2.
Certificazione ANSI/BIFMA.
- *Wide range of colors available.*
 - *Chairs and stools that can be combined with tables in various sizes and formats.*
 - *EN 16139:2013+AC2013 Level 2 certification.
ANSI/BIFMA Certification.*



designed by:
Pio e Tito Toso



**outdoor
ready**



**UV plastic
protection**



**certified
product**

lemon

4-legs

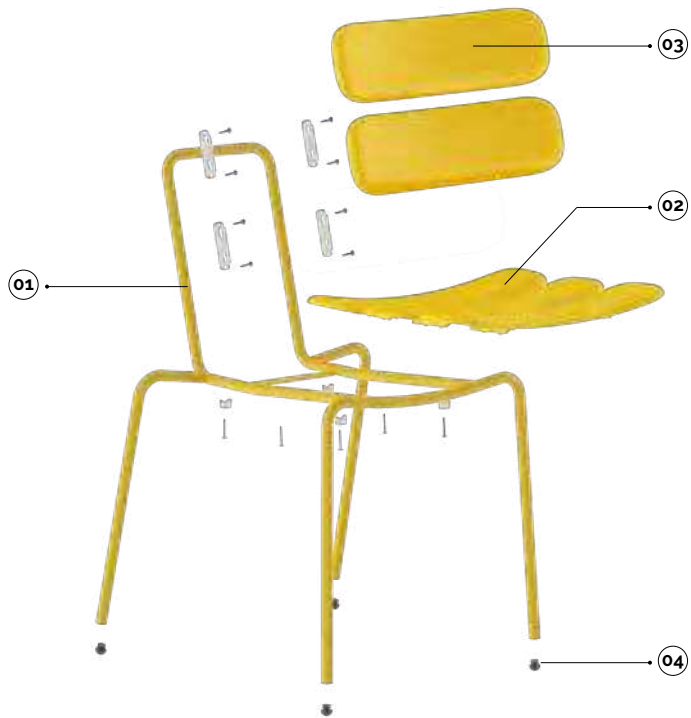
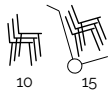

01 02 03 04

plastic colours

- nero/black
- avorio/ivory
- grigio/grey
- giallo/yellow
- verde/green
- rosso/red

main component sizes

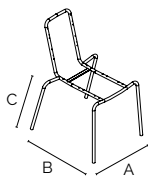

01

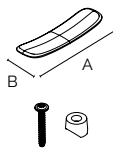

02

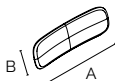

03



04

01 lemon - telaio 4 gambe d.18 senza tappi
lemon - 4 legs frames d.18 without caps

code	finishing	q.kit	q.pack	a	b	c	kg.x1	vol.x1
110103-551	● nero/black*	x1	100	520	565	450	3.20	mc. 0.04
110105-551	● avorio/ivory*	x1	100	520	565	450	3.20	mc. 0.04
110104-551	● grigio/grey*	x1	100	520	565	450	3.20	mc. 0.04
110108-551	● giallo/yellow*	x1	100	520	565	450	3.20	mc. 0.04
110116-551	● verde/green*	x1	100	520	565	450	3.20	mc. 0.04
110102-551	● rosso/red*	x1	100	520	565	450	3.20	mc. 0.04
110110-551	● cromato/chrome**	x1	100	520	565	450	3.20	mc. 0.04

* outdoor/indoor
** indoor

02 lemon - dogia sedile in plastica + viti + paracolpi
lemon - plastic seat stave + screws + buffers

code	finishing	q.kit	q.pack	a	b	kg.x1	vol.x1
132203-110	● nero/black	x3	30	460	135	0.35	mc. 0.002706
132205-110	● avorio/ivory	x3	30	460	135	0.35	mc. 0.002706
132204-110	● grigio/grey	x3	30	460	135	0.35	mc. 0.002706
132208-110	● giallo/yellow	x3	30	460	135	0.35	mc. 0.002706
132216-110	● verde/green	x3	30	460	135	0.35	mc. 0.002706
132202-110	● rosso/red	x3	30	460	135	0.35	mc. 0.002706

03 lemon - dogia schienale in plastica + inserti + viti
lemon - plastic backrest stave + inserts + screws

code	finishing	q.kit	q.pack	a	b	kg.x1	vol.x1
132103-110	● nero/black	x2	20	460	135	0.35	mc. 0.004059
132105-110	● avorio/ivory	x2	20	460	135	0.35	mc. 0.004059
132104-110	● grigio/grey	x2	20	460	135	0.35	mc. 0.004059
132108-110	● giallo/yellow	x2	20	460	135	0.35	mc. 0.004059
132116-110	● verde/green	x2	20	460	135	0.35	mc. 0.004059
132102-110	● rosso/red	x2	20	460	135	0.35	mc. 0.004059

04 lemon - ti18-puntale alettato testa sferica d.18 nero
lemon - ti18-cap d18 spherical head black

code	finishing	q.kit
134203-181	● nero/black	x4

27 lemon - carrello porta sedie con accessori
lemon - chair trolley with accessories

code	finishing	q.kit
110803-449	● nero/black	x1



lemon

4-legs with arms

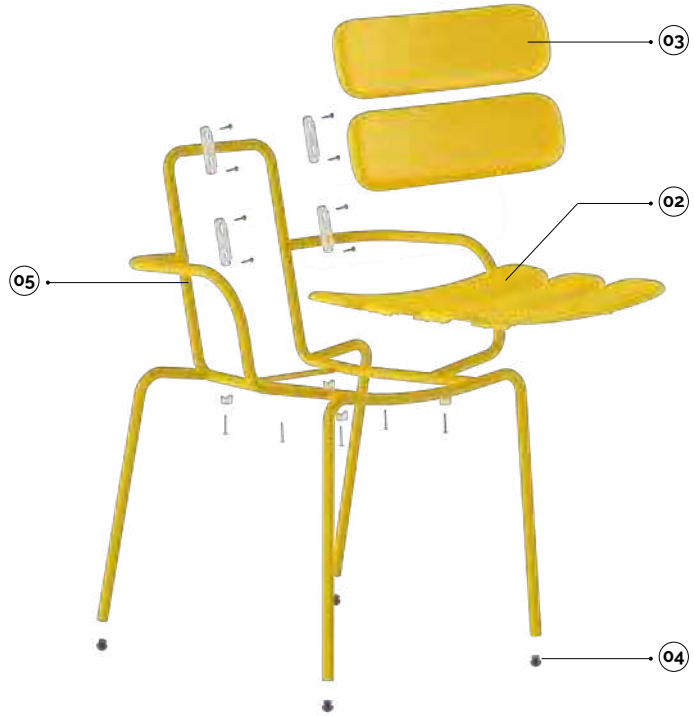
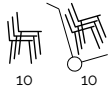

05 02 03 04

plastic colours

- nero/black
- avorio/ivory
- grigio/grey
- giallo/yellow
- verde/green
- rosso/red

main component sizes

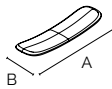
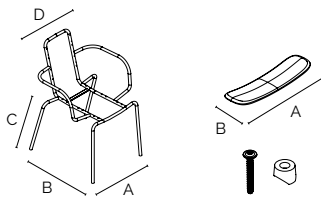

02



03



04

05 lemon - telaio 4 gambe con braccioli d.18 senza tappi
lemon - 4 legs frames with arms d.18 without caps

code	finishing	q.kit	q.pack	a	b	c	d	kg.x1	vol.x1
110103-556	● nero/black*	x1	50	520	565	450	580	4.40	mc. 0.08
110105-556	● avorio/ivory*	x1	50	520	565	450	580	4.40	mc. 0.08
110104-556	● grigio/grey*	x1	50	520	565	450	580	4.40	mc. 0.08
110108-556	● giallo/yellow*	x1	50	520	565	450	580	4.40	mc. 0.08
110116-556	● verde/green*	x1	50	520	565	450	580	4.40	mc. 0.08
110102-556	● rosso/red*	x1	50	520	565	450	580	4.40	mc. 0.08
110110-556	● cromato/chrome**	x1	50	520	565	450	580	4.40	mc. 0.08

* outdoor/indoor
** indoor

02 lemon - dogia sedile in plastica + viti + paracolpi
lemon - plastic seat stave + screws + buffers

code	finishing	q.kit	q.pack	a	b	kg.x1	vol.x1
132203-110	● nero/black	x3	30	460	135	0.35	mc. 0.002706
132205-110	● avorio/ivory	x3	30	460	135	0.35	mc. 0.002706
132204-110	● grigio/grey	x3	30	460	135	0.35	mc. 0.002706
132208-110	● giallo/yellow	x3	30	460	135	0.35	mc. 0.002706
132216-110	● verde/green	x3	30	460	135	0.35	mc. 0.002706
132202-110	● rosso/red	x3	30	460	135	0.35	mc. 0.002706

03 lemon - dogia schienale in plastica + inserti + viti
lemon - plastic backrest stave + inserts + screws

code	finishing	q.kit	q.pack	a	b	kg.x1	vol.x1
132103-110	● nero/black	x2	20	460	135	0.35	mc. 0.004059
132105-110	● avorio/ivory	x2	20	460	135	0.35	mc. 0.004059
132104-110	● grigio/grey	x2	20	460	135	0.35	mc. 0.004059
132108-110	● giallo/yellow	x2	20	460	135	0.35	mc. 0.004059
132116-110	● verde/green	x2	20	460	135	0.35	mc. 0.004059
132102-110	● rosso/red	x2	20	460	135	0.35	mc. 0.004059

04 lemon - ti18-puntale alettato testa sferica d.18 nero
lemon - ti18-cap d.18 spherical head black

code	finishing	q.kit
134203-181	● nero/black	x4

lemon

stool h.650

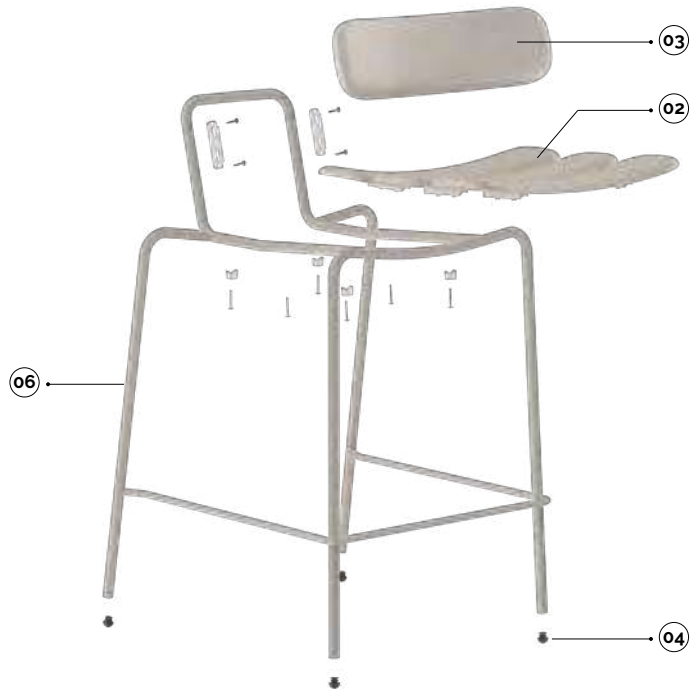

plastic colours

- nero/black
- avorio/ivory
- grigio/grey
- giallo/yellow
- verde/green
- rosso/red

main component sizes

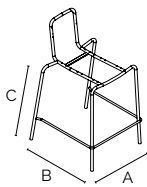

06

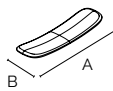

02

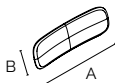

03



04

06 02 03 04

06 lemon - telaio sgabello h650 d.18 senza tappi
lemon - stool frames h650 with arms d.18 without caps

code	finishing	q.kit	q.pack	a	b	c	kg.x1	vol.x1
110603-705	● nero/black	x1	50	530	560	645	5,20	mc. 0,08
110605-705	● avorio/ivory	x1	50	530	560	645	5,20	mc. 0,08
110604-705	● grigio/grey	x1	50	530	560	645	5,20	mc. 0,08
110608-705	● giallo/yellow	x1	50	530	560	645	5,20	mc. 0,08
110616-705	● verde/green	x1	50	530	560	645	5,20	mc. 0,08
110602-705	● rosso/red	x1	50	530	560	645	5,20	mc. 0,08
110610-705	● cromato/chrome**	x1	50	530	560	645	5,20	mc. 0,08

* outdoor/indoor
** indoor

02 lemon - dogia sedile in plastica + viti + paracolpi
lemon - plastic seat stave + screws + buffers

code	finishing	q.kit	q.pack	a	b	kg.x1	vol.x1
132203-110	● nero/black	x3	30	460	135	0,35	mc. 0.002706
132205-110	● avorio/ivory	x3	30	460	135	0,35	mc. 0.002706
132204-110	● grigio/grey	x3	30	460	135	0,35	mc. 0.002706
132208-110	● giallo/yellow	x3	30	460	135	0,35	mc. 0.002706
132216-110	● verde/green	x3	30	460	135	0,35	mc. 0.002706
132202-110	● rosso/red	x3	30	460	135	0,35	mc. 0.002706

03 lemon - dogia schienale in plastica + inserti + viti
lemon - plastic backrest stave + inserts + screws

code	finishing	q.kit	q.pack	a	b	kg.x1	vol.x1
132103-110	● nero/black	x1	20	460	135	0,35	mc. 0.004059
132105-110	● avorio/ivory	x1	20	460	135	0,35	mc. 0.004059
132104-110	● grigio/grey	x1	20	460	135	0,35	mc. 0.004059
132108-110	● giallo/yellow	x1	20	460	135	0,35	mc. 0.004059
132116-110	● verde/green	x1	20	460	135	0,35	mc. 0.004059
132102-110	● rosso/red	x1	20	460	135	0,35	mc. 0.004059

04 lemon - ti18-puntale alettato testa sferica d.18 nero
lemon - ti18-cap d.18 spherical head black

code	finishing	q.kit
134203-181	● nero/black	x4

lemon

stool h.750



plastic colours

- nero/black
- avorio/ivory
- grigio/grey
- giallo/yellow
- verde/green
- rosso/red

main component sizes

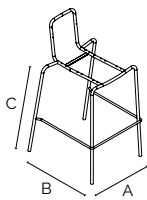

07

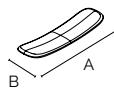

02

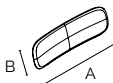

03



04

07 02 03 04

07 lemon - telaio sgabello h750 d.18 senza tappi
lemon - stool frames h750 with arms d.18 without caps

code	finishing	q.kit	q.pack	a	b	c	kg.x1	vol.x1
110603-712	● nero/black	x1	50	530	580	745	5.45	mc. 0.08
110605-712	● avorio/ivory	x1	50	530	580	745	5.45	mc. 0.08
110604-712	● grigio/grey	x1	50	530	580	745	5.45	mc. 0.08
110608-712	● giallo/yellow	x1	50	530	580	745	5.45	mc. 0.08
110616-712	● verde/green	x1	50	530	580	745	5.45	mc. 0.08
110602-712	● rosso/red	x1	50	530	580	745	5.45	mc. 0.08
110610-712	● cromato/chrome**	x1	50	530	580	745	5.45	mc. 0.08

* outdoor/indoor
** indoor

02 lemon - dogia sedile in plastica + viti + paracolpi
lemon - plastic seat stave + screws + buffers

code	finishing	q.kit	q.pack	a	b	kg.x1	vol.x1
132203-110	● nero/black	x3	30	460	135	0.35	mc. 0.002706
132205-110	● avorio/ivory	x3	30	460	135	0.35	mc. 0.002706
132204-110	● grigio/grey	x3	30	460	135	0.35	mc. 0.002706
132208-110	● giallo/yellow	x3	30	460	135	0.35	mc. 0.002706
132216-110	● verde/green	x3	30	460	135	0.35	mc. 0.002706
132202-110	● rosso/red	x3	30	460	135	0.35	mc. 0.002706

03 lemon - dogia schienale in plastica + inserti + viti
lemon - plastic backrest stave + inserts + screws

code	finishing	q.kit	q.pack	a	b	kg.x1	vol.x1
132103-110	● nero/black	x1	20	460	135	0.35	mc. 0.004059
132105-110	● avorio/ivory	x1	20	460	135	0.35	mc. 0.004059
132104-110	● grigio/grey	x1	20	460	135	0.35	mc. 0.004059
132108-110	● giallo/yellow	x1	20	460	135	0.35	mc. 0.004059
132116-110	● verde/green	x1	20	460	135	0.35	mc. 0.004059
132102-110	● rosso/red	x1	20	460	135	0.35	mc. 0.004059

04 lemon - ti18-puntale alettato testa sferica d.18 nero
lemon - ti18-cap d.18 spherical head black

code	finishing	q.kit
134203-181	● nero/black	x4

lemon

medium table



• structure colours

- nero/black
- avorio/ivory
- grigio/grey
- giallo/yellow
- verde/green
- rosso/red
- cromato/chrome

• metal top colours

- nero/black
- avorio/ivory
- grigio/grey
- giallo/yellow
- verde/green
- rosso/red

• hpl top colours

- nero/black
- avorio/ivory

• main component sizes

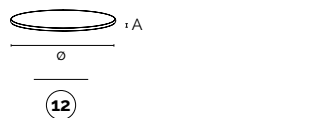
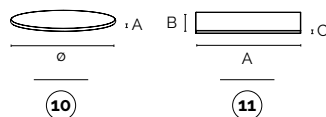
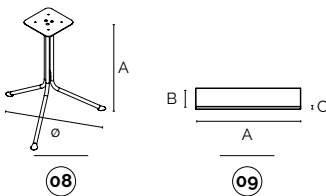

08 lemon - struttura tavolino medio fisso lemon - fixed medium table structure

code	finishing	q.kit	q.pack	ø	a	kg.x1	vol.x1
110303-677	● nero/black*	x1	1	745	730	4,50	mc. 0,0186
110305-677	● avorio/ivory*	x1	1	745	730	4,50	mc. 0,0186
110304-677	● grigio/grey*	x1	1	745	730	4,50	mc. 0,0186
110308-677	● giallo/yellow*	x1	1	745	730	4,50	mc. 0,0186
110316-677	● verde/green*	x1	1	745	730	4,50	mc. 0,0186
110302-677	● rosso/red*	x1	1	745	730	4,50	mc. 0,0186
110310-677	● cromato/chrome**	x1	1	745	730	4,50	mc. 0,0186

* outdoor/indoor
** indoor

09 lemon - top in metallo quadrato 690x690 lemon - metal square top 690x690

code	finishing	q.kit	q.pack	a	b	c	kg.x1	vol.x1
110303-697	● nero/black*/***	x1	1	690	690	20	9,70	mc. 0,0098
110305-697	● avorio/ivory*/***	x1	1	690	690	20	9,70	mc. 0,0098
110304-697	● grigio/grey*/***	x1	1	690	690	20	9,70	mc. 0,0098
110308-697	● giallo/yellow*/***	x1	1	690	690	20	9,70	mc. 0,0098
110316-697	● verde/green*/***	x1	1	690	690	20	9,70	mc. 0,0098
110302-697	● rosso/red*/***	x1	1	690	690	20	9,70	mc. 0,0098

* outdoor/indoor
*** colori disponibili solo in quantità minima d'ordine/colours only available in minimum order quantities

10 lemon - top in metallo rotondo ø700 lemon - metal round top ø700

code	finishing	q.kit	q.pack	ø	a	kg.x1	vol.x1
110303-695	● nero/black*/***	x1	1	700	20	7,70	mc. 0,0098
110305-695	● avorio/ivory*/***	x1	1	700	20	7,70	mc. 0,0098
110304-695	● grigio/grey*/***	x1	1	700	20	7,70	mc. 0,0098
110308-695	● giallo/yellow*/***	x1	1	700	20	7,70	mc. 0,0098
110316-695	● verde/green*/***	x1	1	700	20	7,70	mc. 0,0098
110302-695	● rosso/red*/***	x1	1	700	20	7,70	mc. 0,0098

* outdoor/indoor
*** colori disponibili solo in quantità minima d'ordine/colours only available in minimum order quantities

11 lemon - top in HPL quadrato 690x690 lemon - HPL square top 690x690

code	finishing	q.kit	q.pack	a	b	c	kg.x1	vol.x1
120303-025	● nero/black*	x1	1	690	690	10	7,80	mc. 0,0098
120305-025	● avorio/ivory*	x1	1	690	690	10	7,80	mc. 0,0098

* outdoor/indoor

12 lemon - top in HPL rotondo ø690 lemon - HPL round top ø690

code	finishing	q.kit	q.pack	ø	a	kg.x1	vol.x1
120303-022	● nero/black*	x1	1	690	10	5,70	mc. 0,0098
120305-022	● avorio/ivory*	x1	1	690	10	5,70	mc. 0,0098

* outdoor/indoor

lemon

high table

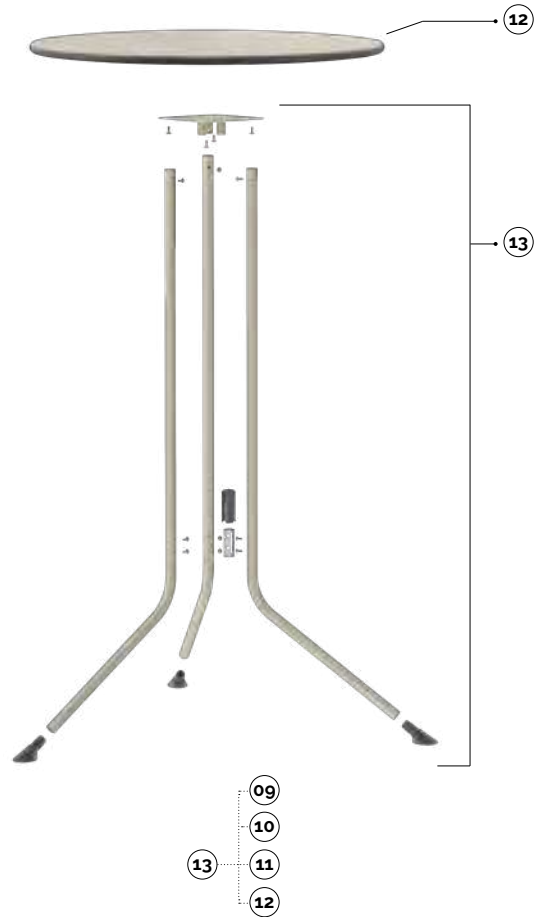
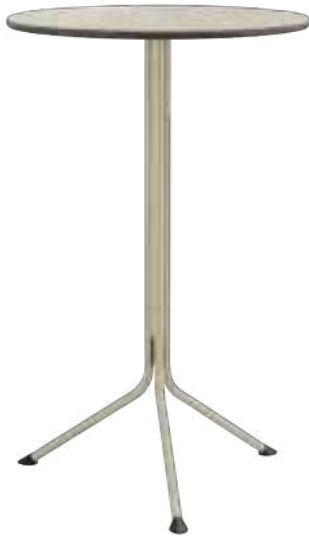

• strutture colours

- nero/black
- avorio/ivory
- grigio/grey
- giallo/yellow
- verde/green
- rosso/red
- cromato/chrome

• metal top colours

- nero/black
- avorio/ivory
- grigio/grey
- giallo/yellow
- verde/green
- rosso/red

• hpl top colours

- nero/black
- avorio/ivory

• main component sizes

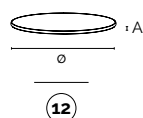
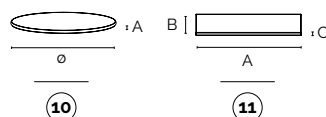
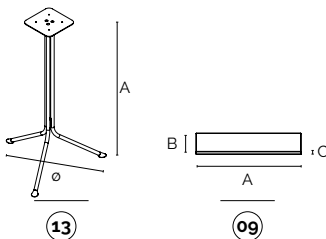

13 lemon - struttura tavolino alto fisso lemon - fixed high table structure

code	finishing	q.kit	q.pack	ø	a	kg.x1	vol.x1
110303-678	● nero/black*	x1	1	745	1100	5,50	mc. 0,0272
110305-678	● avorio/ivory*	x1	1	745	1100	5,50	mc. 0,0272
110304-678	● grigio/grey*	x1	1	745	1100	5,50	mc. 0,0272
110308-678	● giallo/yellow*	x1	1	745	1100	5,50	mc. 0,0272
110316-678	● verde/green*	x1	1	745	1100	5,50	mc. 0,0272
110302-678	● rosso/red*	x1	1	745	1100	5,50	mc. 0,0272
110310-678	● cromato/chrome**	x1	1	745	1100	5,50	mc. 0,0272

* outdoor/indoor
** indoor

09 lemon - top in metallo quadrato 690x690 lemon - metal square top 690x690

code	finishing	q.kit	q.pack	a	b	c	kg.x1	vol.x1
110303-697	● nero/black*/***	x1	1	690	690	20	9,70	mc. 0,0098
110305-697	● avorio/ivory*/***	x1	1	690	690	20	9,70	mc. 0,0098
110304-697	● grigio/grey*/***	x1	1	690	690	20	9,70	mc. 0,0098
110308-697	● giallo/yellow*/***	x1	1	690	690	20	9,70	mc. 0,0098
110316-697	● verde/green*/***	x1	1	690	690	20	9,70	mc. 0,0098
110302-697	● rosso/red*/***	x1	1	690	690	20	9,70	mc. 0,0098

* outdoor/indoor
*** colori disponibili solo in quantità minima d'ordine/colours only available in minimum order quantities

10 lemon - top in metallo rotondo ø700 lemon - metal round top ø700

code	finishing	q.kit	q.pack	ø	a	kg.x1	vol.x1
110303-695	● nero/black*/***	x1	1	700	20	7,70	mc. 0,0098
110305-695	● avorio/ivory*/***	x1	1	700	20	7,70	mc. 0,0098
110304-695	● grigio/grey*/***	x1	1	700	20	7,70	mc. 0,0098
110308-695	● giallo/yellow*/***	x1	1	700	20	7,70	mc. 0,0098
110316-695	● verde/green*/***	x1	1	700	20	7,70	mc. 0,0098
110302-695	● rosso/red*/***	x1	1	700	20	7,70	mc. 0,0098

* outdoor/indoor
*** colori disponibili solo in quantità minima d'ordine/colours only available in minimum order quantities

11 lemon - top in HPL quadrato 690x690 lemon - HPL square top 690x690

code	finishing	q.kit	q.pack	a	b	c	kg.x1	vol.x1
120303-025	● nero/black*	x1	1	690	690	10	7,80	mc. 0,0098
120305-025	● avorio/ivory*	x1	1	690	690	10	7,80	mc. 0,0098

* outdoor/indoor

12 lemon - top in HPL rotondo ø690 lemon - HPL round top ø690

code	finishing	q.kit	q.pack	ø	a	kg.x1	vol.x1
120303-022	● nero/black*	x1	1	690	10	5,70	mc. 0,0098
120305-022	● avorio/ivory*	x1	1	690	10	5,70	mc. 0,0098

* outdoor/indoor

lemon

tilting medium table

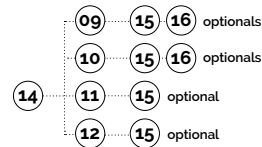
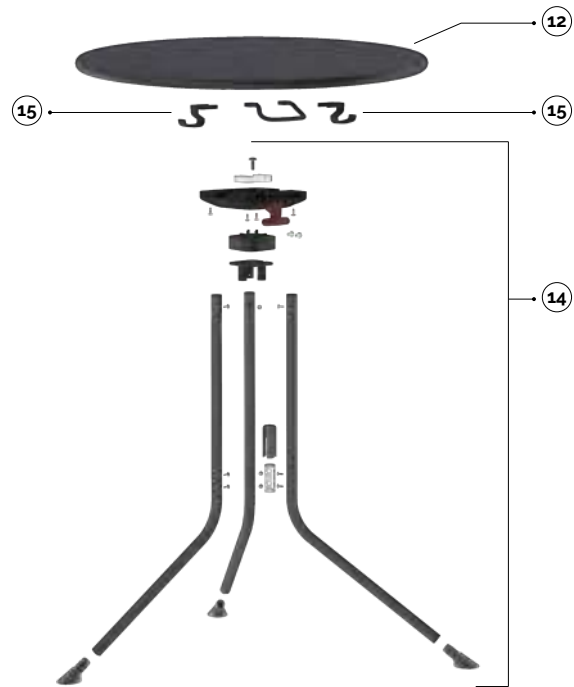

• strutture colours

- nero/black
- avorio/ivory
- grigio/grey
- giallo/yellow
- verde/green
- rosso/red
- cromato/chrome

• metal top colours

- nero/black
- avorio/ivory
- grigio/grey
- giallo/yellow
- verde/green
- rosso/red

• hpl top colours

- nero/black
- avorio/ivory

• main component sizes

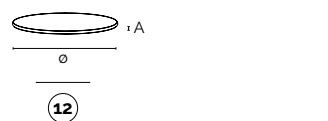
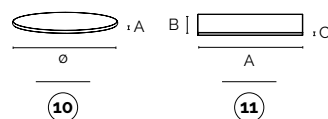
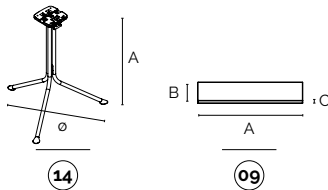

14 lemon - struttura tavolino medio ribaltabile lemon - tilting medium table structure

code	finishing	q.kit	q.pack	ø	a	kg.x1	vol.x1
110303-675	● nero/black*	x1	1	745	730	4.30	mc. 0.0186
110305-675	● avorio/ivory*	x1	1	745	730	4.30	mc. 0.0186
110304-675	● grigio/grey*	x1	1	745	730	4.30	mc. 0.0186
110308-675	● giallo/yellow*	x1	1	745	730	4.30	mc. 0.0186
110316-675	● verde/green*	x1	1	745	730	4.30	mc. 0.0186
110302-675	● rosso/red*	x1	1	745	730	4.30	mc. 0.0186
110310-675	● cromato/chrome**	x1	1	745	730	4.30	mc. 0.0186

* outdoor/indoor
** indoor

09 lemon - top in metallo quadrato 690x690 lemon - metal square top 690x690

code	finishing	q.kit	q.pack	a	b	c	kg.x1	vol.x1
110303-697	● nero/black*/***	x1	1	690	690	20	9.70	mc. 0.0098
110305-697	● avorio/ivory*/***	x1	1	690	690	20	9.70	mc. 0.0098
110304-697	● grigio/grey*/***	x1	1	690	690	20	9.70	mc. 0.0098
110308-697	● giallo/yellow*/***	x1	1	690	690	20	9.70	mc. 0.0098
110316-697	● verde/green*/***	x1	1	690	690	20	9.70	mc. 0.0098
110302-697	● rosso/red*/***	x1	1	690	690	20	9.70	mc. 0.0098

* outdoor/indoor
*** colori disponibili solo in quantità minima d'ordine/colours only available in minimum order quantities

10 lemon - top in metallo rotondo ø700 lemon - metal round top ø700

code	finishing	q.kit	q.pack	ø	a	kg.x1	vol.x1
110303-695	● nero/black*/***	x1	1	700	20	7.70	mc. 0.0098
110305-695	● avorio/ivory*/***	x1	1	700	20	7.70	mc. 0.0098
110304-695	● grigio/grey*/***	x1	1	700	20	7.70	mc. 0.0098
110308-695	● giallo/yellow*/***	x1	1	700	20	7.70	mc. 0.0098
110316-695	● verde/green*/***	x1	1	700	20	7.70	mc. 0.0098
110302-695	● rosso/red*/***	x1	1	700	20	7.70	mc. 0.0098

* outdoor/indoor
*** colori disponibili solo in quantità minima d'ordine/colours only available in minimum order quantities

11 lemon - top in HPL quadrato 690x690 lemon - HPL square top 690x690

code	finishing	q.kit	q.pack	a	b	c	kg.x1	vol.x1
120303-025	● nero/black*	x1	1	690	690	10	7.80	mc. 0.0098
120305-025	● avorio/ivory*	x1	1	690	690	10	7.80	mc. 0.0098

* outdoor/indoor

12 lemon - top in HPL rotondo ø690 lemon - HPL round top ø690

code	finishing	q.kit	q.pack	ø	a	kg.x1	vol.x1
120303-022	● nero/black*	x1	1	690	10	5.70	mc. 0.0098
120305-022	● avorio/ivory*	x1	1	690	10	5.70	mc. 0.0098

* outdoor/indoor

15 lemon - kit maniglia + 2 agganci in plastica neri (per tavolo ribaltabile) lemon - kit black plastic handle + 2 hooks (for folding table structure)

code	finishing	q.kit	q.pack
130303-025	● nero/black*	x1	1

16 lemon - piastra per kit maniglia + agganci con piano in metallo lemon - sheet metal for kit black plastic handle + hooks with metal top

code	finishing	q.kit	q.pack
113003-140	● nero/black*	x1	10

lemon

tilting high table

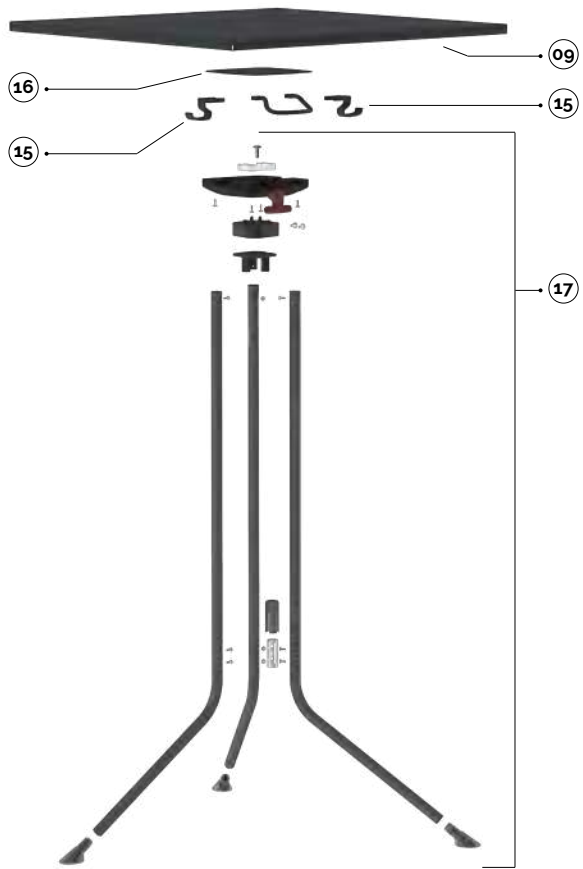

• strutture colours

- nero/black
- avorio/ivory
- grigio/grey
- giallo/yellow
- verde/green
- rosso/red
- cromato/chrome

• metal top colours

- nero/black
- avorio/ivory
- grigio/grey
- giallo/yellow
- verde/green
- rosso/red

• hpl top colours

- nero/black
- avorio/ivory

• main component sizes

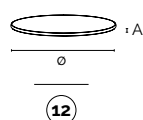
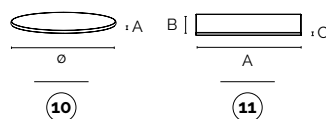
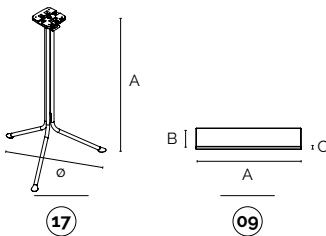

17 lemon - struttura tavolino alto ribaltabile lemon - tilting high table structure

code	finishing	q.kit	q.pack	ø	a	kg.x1	vol.x1
110303-676	● nero/black*	x1	1	745	1100	5,30	mc. 0,0272
110305-676	● avorio/ivory*	x1	1	745	1100	5,30	mc. 0,0272
110304-676	● grigio/grey*	x1	1	745	1100	5,30	mc. 0,0272
110308-676	● giallo/yellow*	x1	1	745	1100	5,30	mc. 0,0272
110316-676	● verde/green*	x1	1	745	1100	5,30	mc. 0,0272
110302-676	● rosso/red*	x1	1	745	1100	5,30	mc. 0,0272
110310-676	● cromato/chrome**	x1	1	745	1100	5,30	mc. 0,0272

* outdoor/indoor
** indoor

09 lemon - top in metallo quadrato 690x690 lemon - metal square top 690x690

code	finishing	q.kit	q.pack	a	b	c	kg.x1	vol.x1
110303-697	● nero/black*/***	x1	1	690	690	20	9,70	mc. 0,0098
110305-697	● avorio/ivory*/***	x1	1	690	690	20	9,70	mc. 0,0098
110304-697	● grigio/grey*/***	x1	1	690	690	20	9,70	mc. 0,0098
110308-697	● giallo/yellow*/***	x1	1	690	690	20	9,70	mc. 0,0098
110316-697	● verde/green*/***	x1	1	690	690	20	9,70	mc. 0,0098
110302-697	● rosso/red*/***	x1	1	690	690	20	9,70	mc. 0,0098

* outdoor/indoor

*** colori disponibili solo in quantità minima d'ordine/colours only available in minimum order quantities

10 lemon - top in metallo rotondo ø700 lemon - metal round top ø700

code	finishing	q.kit	q.pack	ø	a	kg.x1	vol.x1
110303-695	● nero/black*/***	x1	1	700	20	7,70	mc. 0,0098
110305-695	● avorio/ivory*/***	x1	1	700	20	7,70	mc. 0,0098
110304-695	● grigio/grey*/***	x1	1	700	20	7,70	mc. 0,0098
110308-695	● giallo/yellow*/***	x1	1	700	20	7,70	mc. 0,0098
110316-695	● verde/green*/***	x1	1	700	20	7,70	mc. 0,0098
110302-695	● rosso/red*/***	x1	1	700	20	7,70	mc. 0,0098

* outdoor/indoor

*** colori disponibili solo in quantità minima d'ordine/colours only available in minimum order quantities

11 lemon - top in HPL quadrato 690x690 lemon - HPL square top 690x690

code	finishing	q.kit	q.pack	a	b	c	kg.x1	vol.x1
120303-025	● nero/black*	x1	1	690	690	10	7,80	mc. 0,0098
120305-025	● avorio/ivory*	x1	1	690	690	10	7,80	mc. 0,0098

* outdoor/indoor

12 lemon - top in HPL rotondo ø690 lemon - HPL round top ø690

code	finishing	q.kit	q.pack	ø	a	kg.x1	vol.x1
120303-022	● nero/black*	x1	1	690	10	5,70	mc. 0,0098
120305-022	● avorio/ivory*	x1	1	690	10	5,70	mc. 0,0098

* outdoor/indoor

for the components below, see previous pages

15 16

lemon

rectangular medium table



• structure colours

- nero/black
- avorio/ivory
- grigio/grey
- giallo/yellow
- verde/green
- rosso/red
- cromato/chrome

• metal top colours

- nero/black
- avorio/ivory
- grigio/grey
- giallo/yellow
- verde/green
- rosso/red

• hpl top colours

- nero/black
- avorio/ivory

• main component sizes

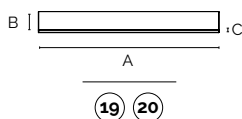
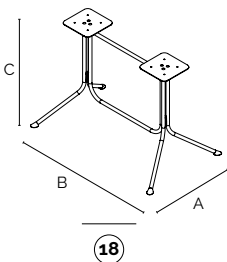

18 lemon - kit struttura tavolo medio fisso rettangolare
lemon - kit fixed rectangular medium table structure

code	finishing	q.kit	q.pack	a	b	c	kg.x1	vol.x1
110303-679	● nero/black*	x1	1	650	1070	730	9.45	mc. 0.025
110305-679	● avorio/ivory*	x1	1	650	1070	730	9.45	mc. 0.025
110304-679	● grigio/grey*	x1	1	650	1070	730	9.45	mc. 0.025
110308-679	● giallo/yellow*	x1	1	650	1070	730	9.45	mc. 0.025
110316-679	● verde/green*	x1	1	650	1070	730	9.45	mc. 0.025
110302-679	● rosso/red*	x1	1	650	1070	730	9.45	mc. 0.025
110310-679	● cromato/chrome**	x1	1	650	1070	730	9.45	mc. 0.025

* outdoor/indoor
** indoor

19 lemon - top in metallo rettangolare 1190x690
lemon - metal rectangular top 1190x690

code	finishing	q.kit	q.pack	a	b	c	kg.x1	vol.x1
110303-698	● nero/black*/***	x1	1	1190	690	20	17.80	mc. 0.0168
110305-698	● avorio/ivory*/***	x1	1	1190	690	20	17.80	mc. 0.0168
110304-698	● grigio/grey*/***	x1	1	1190	690	20	17.80	mc. 0.0168
110308-698	● giallo/yellow*/***	x1	1	1190	690	20	17.80	mc. 0.0168
110316-698	● verde/green*/***	x1	1	1190	690	20	17.80	mc. 0.0168
110302-698	● rosso/red*/***	x1	1	1190	690	20	17.80	mc. 0.0168

* outdoor/indoor
*** colori disponibili solo in quantità minima d'ordine/colours only available in minimum order quantities

20 lemon - top in HPL rettangolare 1190x690
lemon - HPL rectangular top 1190x690

code	finishing	q.kit	q.pack	a	b	c	kg.x1	vol.x1
120303-020	● nero/black*	x1	1	1190	690	10	13.5	mc. 0.0168
120305-020	● avorio/ivory*	x1	1	1190	690	10	13.5	mc. 0.0168

* outdoor/indoor

lemon

rectangular medium table



• structure colours

- nero/black
- avorio/ivory
- grigio/grey
- giallo/yellow
- verde/green
- rosso/red
- cromato/chrome

• metal top colours

- nero/black
- avorio/ivory
- grigio/grey
- giallo/yellow
- verde/green
- rosso/red

• hpl top colours

- nero/black
- avorio/ivory

• main component sizes

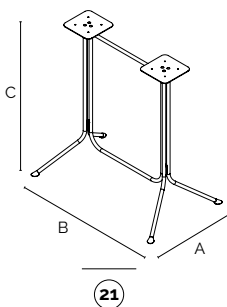

21

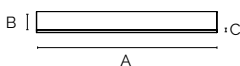

19 20

21 lemon - kit struttura tavolo alto fisso rettangolare
lemon - kit fixed rectangular high table structure

code	finishing	q.kit	q.pack	a	b	c	kg.x1	vol.x1
110303-686	● nero/black*	x1	1	650	1070	1100	11,57	mc. 0,037
110305-686	● avorio/ivory*	x1	1	650	1070	1100	11,57	mc. 0,037
110304-686	● grigio/grey*	x1	1	650	1070	1100	11,57	mc. 0,037
110308-686	● giallo/yellow*	x1	1	650	1070	1100	11,57	mc. 0,037
110316-686	● verde/green*	x1	1	650	1070	1100	11,57	mc. 0,037
110302-686	● rosso/red*	x1	1	650	1070	1100	11,57	mc. 0,037
110310-686	● cromato/chrome**	x1	1	650	1070	1100	11,57	mc. 0,037

* outdoor/indoor
** indoor

19 lemon - top in metallo rettangolare 1190x690
lemon - metal rectangular top 1190x690

code	finishing	q.kit	q.pack	a	b	c	kg.x1	vol.x1
110303-698	● nero/black*/***	x1	1	1190	690	20	17,80	mc. 0,0168
110305-698	● avorio/ivory*/***	x1	1	1190	690	20	17,80	mc. 0,0168
110304-698	● grigio/grey*/***	x1	1	1190	690	20	17,80	mc. 0,0168
110308-698	● giallo/yellow*/***	x1	1	1190	690	20	17,80	mc. 0,0168
110316-698	● verde/green*/***	x1	1	1190	690	20	17,80	mc. 0,0168
110302-698	● rosso/red*/***	x1	1	1190	690	20	17,80	mc. 0,0168

* outdoor/indoor
*** colori disponibili solo in quantità minima d'ordine/colours only available in minimum order quantities

20 lemon - top in HPL rettangolare 1190x690
lemon - HPL rectangular top 1190x690

code	finishing	q.kit	q.pack	a	b	c	kg.x1	vol.x1
120303-020	● nero/black*	x1	1	1190	690	10	13,5	mc. 0,0168
120305-020	● avorio/ivory*	x1	1	1190	690	10	13,5	mc. 0,0168

* outdoor/indoor

lemon

coffee table

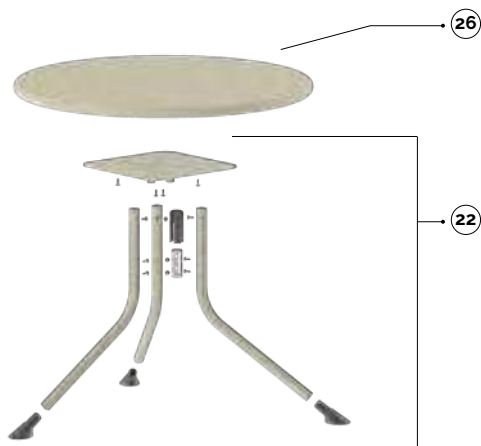

• strutture colours

- nero/black
- avorio/ivory
- grigio/grey
- giallo/yellow
- verde/green
- rosso/red
- cromato/chrome

• metal top colours

- nero/black
- avorio/ivory
- grigio/grey
- giallo/yellow
- verde/green
- rosso/red

• hpl top colours

- nero/black
- avorio/ivory

• main component sizes

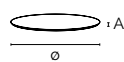
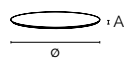
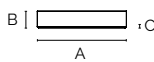
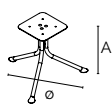

22 lemon - struttura tavolino coffee fisso lemon - fixed coffee table structure

code	finishing	q.kit	q.pack	ø	a	kg.x1	vol.x1
110303-726	● nero/black*	x1	2	590	390	3,50	mc. 0.0093
110305-726	● avorio/ivory*	x1	2	590	390	3,50	mc. 0.0093
110304-726	● grigio/grey*	x1	2	590	390	3,50	mc. 0.0093
110308-726	● giallo/yellow*	x1	2	590	390	3,50	mc. 0.0093
110316-726	● verde/green*	x1	2	590	390	3,50	mc. 0.0093
110302-726	● rosso/red*	x1	2	590	390	3,50	mc. 0.0093
110310-726	● cromato/chrome**	x1	2	590	390	3,50	mc. 0.0093

* outdoor/indoor
** indoor

23 lemon - top in metallo quadrato 590x590 lemon - metal square top 590x590

code	finishing	q.kit	q.pack	a	b	c	kg.x1	vol.x1
110303-696	● nero/black'/'**	x1	1	590	590	20	7,45	mc. 0.0072
110305-696	● avorio/ivory'/'**	x1	1	590	590	20	7,45	mc. 0.0072
110304-696	● grigio/grey'/'**	x1	1	590	590	20	7,45	mc. 0.0072
110308-696	● giallo/yellow'/'**	x1	1	590	590	20	7,45	mc. 0.0072
110316-696	● verde/green'/'**	x1	1	590	590	20	7,45	mc. 0.0072
110302-696	● rosso/red'/'**	x1	1	590	590	20	7,45	mc. 0.0072

* outdoor/indoor
** colori disponibili solo in quantità minima d'ordine/colours only available in minimum order quantities

24 lemon - top in metallo rotondo ø600 lemon - metal round top ø600

code	finishing	q.kit	q.pack	ø	a	kg.x1	vol.x1
110303-694	● nero/black'/'**	x1	1	600	20	5,80	mc. 0.0072
110305-694	● avorio/ivory'/'**	x1	1	600	20	5,80	mc. 0.0072
110304-694	● grigio/grey'/'**	x1	1	600	20	5,80	mc. 0.0072
110308-694	● giallo/yellow'/'**	x1	1	600	20	5,80	mc. 0.0072
110316-694	● verde/green'/'**	x1	1	600	20	5,80	mc. 0.0072
110302-694	● rosso/red'/'**	x1	1	600	20	5,80	mc. 0.0072

* outdoor/indoor
** colori disponibili solo in quantità minima d'ordine/colours only available in minimum order quantities

25 lemon - top in HPL quadrato 590x590 lemon - HPL square top 590x590

code	finishing	q.kit	q.pack	a	b	c	kg.x1	vol.x1
120303-024	● nero/black*	x1	1	590	590	10	5,70	mc. 0.0072
120305-024	● avorio/ivory*	x1	1	590	590	10	5,70	mc. 0.0072

* outdoor/indoor

26 lemon - top in HPL rotondo ø590 lemon - HPL round top ø590

code	finishing	q.kit	q.pack	ø	a	kg.x1	vol.x1
120303-021	● nero/black*	x1	1	590	10	4,00	mc. 0.0072
120305-021	● avorio/ivory*	x1	1	590	10	4,00	mc. 0.0072

* outdoor/indoor





xylo



discover more about
Xylo Collection

Una collezione di sedie e sgabelli con monoscocca in legno di faggio o impiallacciata rovere, poggiata su una larga varietà di telai in metallo, dal classico quattro gambe, alla versatile base a 4 razze su ruote, fino alla versione panca.

La relazione tra legno e metallo fa della collezione di sedute Xylo una soluzione d'arredo senza tempo, capace di trovare facilmente spazio in qualsiasi ambiente, dalle zone ristorazione collettive ai contesti domestici.

A collection of chairs and stools with beech or plywood monoshell resting on a wide variety of metal frames, from the classic four-leg, to the versatile 4-spoke base on wheels, to the bench version.

The relationship between wood and metal makes the Xylo seating collection a timeless furniture solution that can easily find a place in any environment, from collective dining areas to domestic settings.

Plus

- Ampio assortimento di telai e basi.
- Certificazione EN 16139:2013+AC2013 Livello1.
- Monoscocca tappezzabile.
- *Wide assortment of frames and bases.*
- *EN 16139:2013+AC2013 Level 1 Certification.*
- *Upholsterable monoshell.*



designed by:
Stefano Bettio



**certified
product**



**trolley
available**

xylo

4-legs

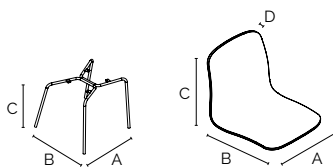
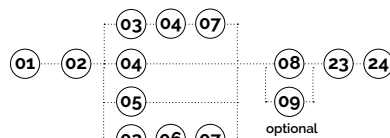
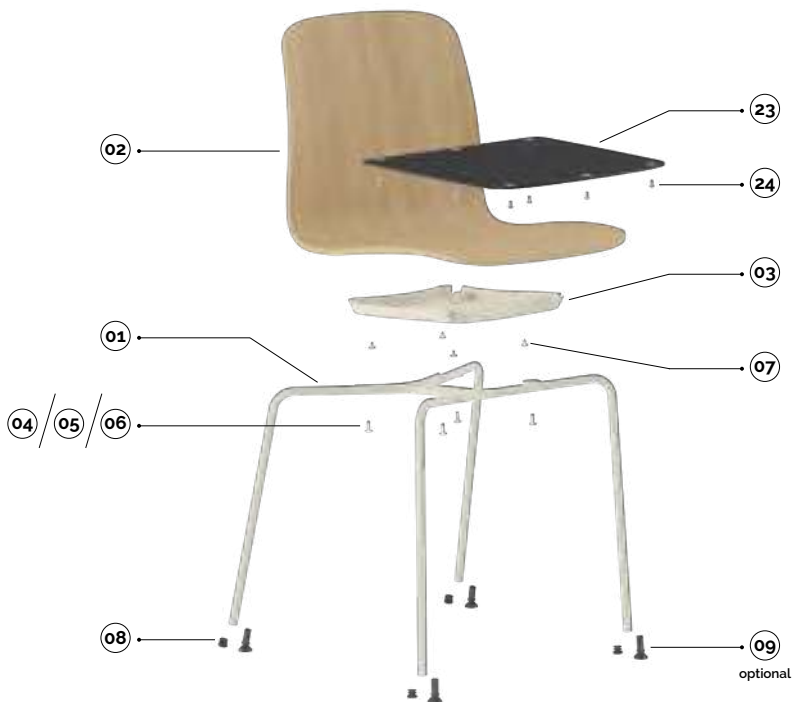
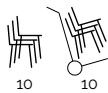

01

02

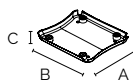

03



04

05

06

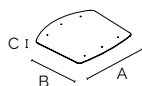

07



08



09



22 xylo - carrello porta sedie con accessori
xylo - chair trolley with accessories

code	finishing	q.kit
110803-448	● nero/black	x1

01 xylo - telaio 4 gambe d.16 senza tappi
xylo - 4 legs frames d.16 without caps

code	finishing	q.kit	q.pack	a	b	c	kg.x1	vol.x1
110103-464	● nero/black	x1	200	535	505	455	2.00	mc. 0.02
110105-464	● avorio/ivory	x1	200	535	505	455	2.00	mc. 0.02
110110-464	● cromato/chrome	x1	200	535	505	455	2.00	mc. 0.02

02 xylo - scocca in legno per telaio 4 gambe/slitta/base fissa 4 razze/panca
xylo - plywood shell for 4-legs/slide/4 star fixed base/bench frames

code	finishing	q.kit	q.pack	a	b	c	d	kg.x1	vol.x1
123907-004	● faggio/beech wood	x1	5	440	510	410	12	3.00	mc. 0.0312
123907-006	● rovere/oak wood	x1	5	440	510	410	12	3.00	mc. 0.0312
123901-000	● grezza da tappezzare/upholsterable version	x1	5	440	510	410	12	3.00	mc. 0.0312

03 xylo - copertina in plastica
xylo - plastic cover

code	finishing	q.kit	q.pack	a	b	c	kg.x1	vol.x1
132203-043	● nero/black	x1	10	260	310	30	0.25	mc. 0.0025
132205-040	● avorio/ivory	x1						

04 xylo - vite m6x16 per fissaggio scocca faggio/rovere con copertina o per fissaggio scocca da tappezzare senza copertina
xylo - m6x16 screw for fixing beech/oak shell with cover or for fixing upholsterable shell without cover

code	finishing	q.kit
117711-185	○ zincat bianca/white zinc	x4

05 xylo - vite TBEI m6x10 per fissaggio scocca faggio/rovere senza copertina
xylo - TBEI screw m6x10 for fixing beech/oak shell without cover

code	finishing	q.kit
117711-540	○ zincat bianca/white zinc	x4

06 xylo - vite TBEI 10.g M6x20 per fissaggio scocca da tappezzare con copertina
xylo - TBEI screw 10.g fm6x20 for fixing upholsterable shell with cover

code	finishing	q.kit
117711-211	○ zincat bianca/white zinc	x4

07 xylo - paracolpi in PVC con testa bombata
xylo - PVC buffer with round head

code	finishing	q.kit
134406-000	○ neutro/neutral	x4

08 xylo - puntale alettato tondo d.16 nero
xylo - inner cap for legs d.16 black

code	finishing	q.kit
134203-160	● nero/black	x4

09 xylo - piedino ad inclinazione variabile d.16 nero
xylo - variable inclination glide d.16 black

code	finishing	q.kit
134203-163	● nero/black	x4

for the components below, see next page

23 24

xylo

4-legs w/armrests

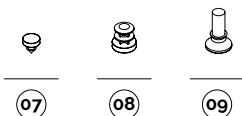
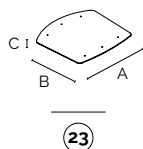
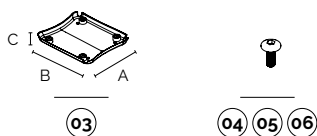
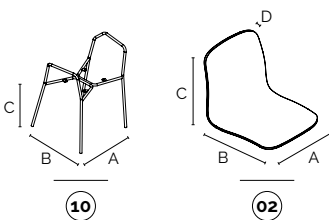
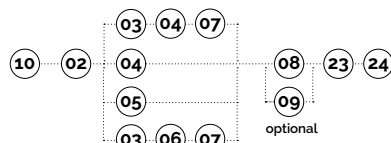
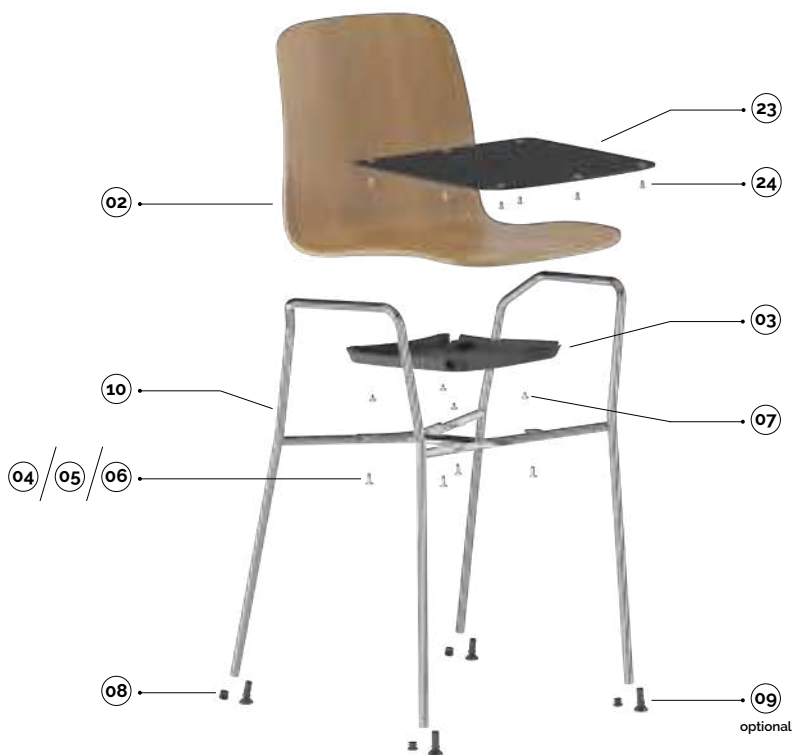
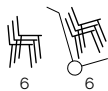

main component sizes

10 xylo - telaio 4 gambe con braccioli d.16 senza tappi
xylo - 4 legs frames with arms d.16 without caps

code	finishing	q.kit	q.pack	a	b	c	kg.x1	vol.x1
110103-463	● nero/black	x1	60	535	505	455	3.15	mc. 0.035
110105-463	● avorio/ivory	x1	60	535	505	455	3.15	mc. 0.035
110110-463	● cromato/chrome	x1	60	535	505	455	3.15	mc. 0.035

02 xylo - scocca in legno per telaio 4 gambe/slitta/base fissa 4 razze/panca
xylo - plywood shell for 4-legs/slide/4 star fixed base/bench frames

code	finishing	q.kit	q.pack	a	b	c	d	kg.x1	vol.x1
123907-004	● faggio/beech wood	x1	5	440	510	410	12	3.00	mc. 0.0312
123907-006	● rovere/oak wood	x1	5	440	510	410	12	3.00	mc. 0.0312
123901-000	● grezza da tappezzare/upholsterable version	x1	5	440	510	410	12	3.00	mc. 0.0312

03 xylo - copertina in plastica
xylo - plastic cover

code	finishing	q.kit	q.pack	a	b	c	kg.x1	vol.x1
132203-043	● nero/black	x1	10	260	310	30	0.25	mc. 0.0025
132205-040	● avorio/ivory	x1						

04 xylo - vite m6x16 per fissaggio scocca faggio/rovere con copertina o per fissaggio scocca da tappezzare senza copertina
xylo - m6x16 screw for fixing beech/oak shell with cover or for fixing upholsterable shell without cover

code	finishing	q.kit
117711-185	○ zincat bianca/white zinc	x4

05 xylo - vite TBEI m6x10 per fissaggio scocca faggio/rovere senza copertina
xylo - TBEI screw m6x10 for fixing beech/oak shell without cover

code	finishing	q.kit
117711-540	○ zincat bianca/white zinc	x4

06 xylo - vite TBEI 10.g M6x20 per fissaggio scocca da tappezzare con copertina
xylo - TBEI screw 10.g fm6x20 for fixing upholsterable shell with cover

code	finishing	q.kit
117711-211	○ zincat bianca/white zinc	x4

23 xylo - pannello sedile in plastica con 6 borchie
xylo - plastic seat panel with 6 upholstery nails

code	finishing	q.kit	a	b	c	kg.x1
132203-095	● nero/black	x1	413	387	4	0.60

24 xylo - viti per il fissaggio del pannello
xylo - screws for panel fixing

code	finishing	q.kit
117711-120	○ zincat bianca/white zinc	x6

for the components below, see previous page

07 **08** **09**

xylo

stool h.650

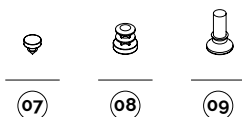
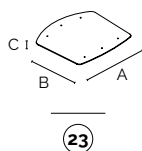
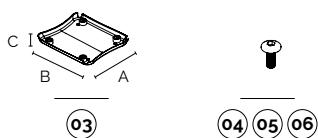
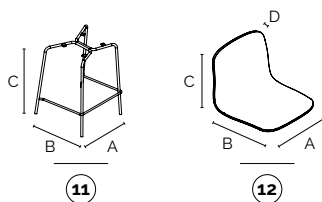
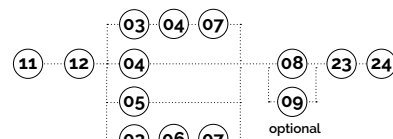
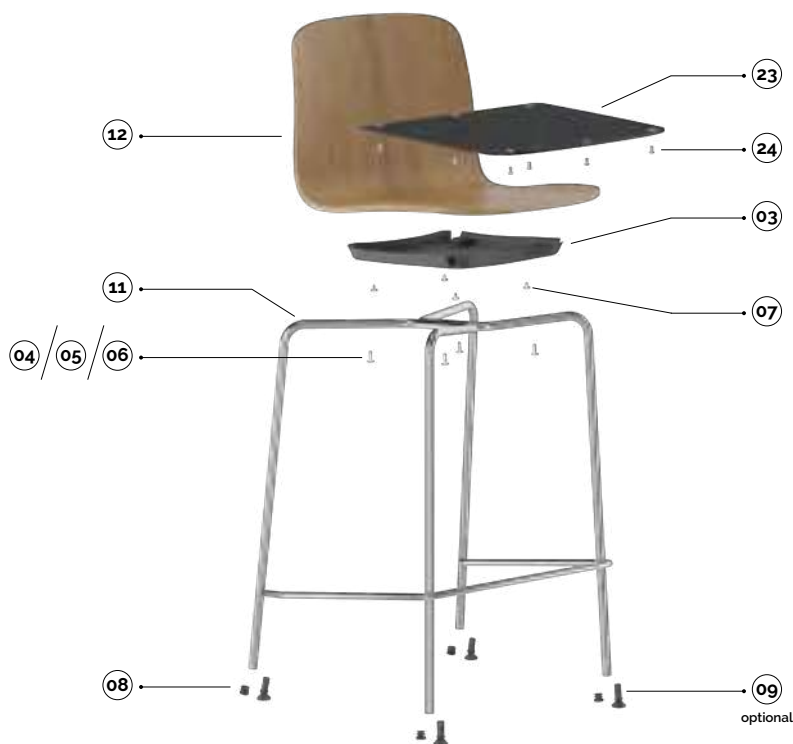

11 xylo - telaio sgabello h.650 d.16 senza tappi

xylo - stool frames h.650 d.16 without caps

code	finishing	q.kit	q.pack	a	b	c	kg.x1	vol.x1
110603-660	● nero/black	x1	50	485	465	640	3,70	mc. 0,08
110605-660	● avorio/ivory ral 1013	x1	50	485	465	640	3,70	mc. 0,08
110610-660	● cromato/chrome	x1	50	485	465	640	3,70	mc. 0,08

12 xylo - scocca in legno per telaio sgabello

xylo - plywood shell for stool frame

code	finishing	q.kit	q.pack	a	b	c	d	kg.x1	vol.x1
123907-005	● faggio/beech wood	x1	5	410	420	340	12	2,30	mc. 0,0312
123907-007	● rovere/oak wood	x1	5	410	420	340	12	2,30	mc. 0,0312
123901-001	● grezza da tappezzare/upholsterable version	x1	5	410	420	340	12	2,30	mc. 0,0312

03 xylo - copertina in plastica

xylo - plastic cover

code	finishing	q.kit	q.pack	a	b	c	kg.x1	vol.x1
132203-043	● nero/black ral 9005	x1	10	260	310	30	0,25	mc. 0,0025
132205-040	● avorio/ivory ral 1013	x1						

04 xylo - vite m6x16 per fissaggio scocca faggio/rovere con copertina o per fissaggio scocca da tappezzare senza copertina

xylo - m6x16 screw for fixing beech/oak shell with cover or for fixing upholsterable shell without cover

code	finishing	q.kit
117711-185	○ zincat bianca/white zinc	x4

05 xylo - vite TBEI m6x10 per fissaggio scocca faggio/rovere senza copertina

xylo - TBEI screw m6x10 for fixing beech/oak shell without cover

code	finishing	q.kit
117711-540	○ zincat bianca/white zinc	x4

06 xylo - vite TBEI 10.g M6x20 per fissaggio scocca da tappezzare con copertina

xylo - TBEI screw 10.g fm6x20 for fixing upholsterable shell with cover

code	finishing	q.kit
117711-211	○ zincat bianca/white zinc	x4

07 xylo - paracolpi in PVC con testa bombata

xylo - PVC buffer with round head

code	finishing	q.kit
134406-000	○ neutro/neutral	x4

08 xylo - puntale alettato tondo d.16 nero

xylo - inner cap for legs d.16 black

code	finishing	q.kit
134203-160	● nero/black	x4

09 xylo - piedino ad inclinazione variabile d.16 nero

xylo - variable inclination glide d.16 black

code	finishing	q.kit
134203-163	● nero/black	x4

for the components below, see next page



xylo

stool h.750

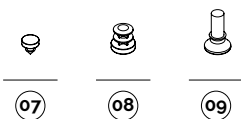
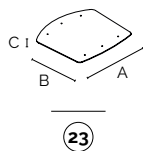
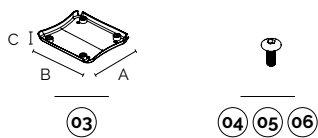
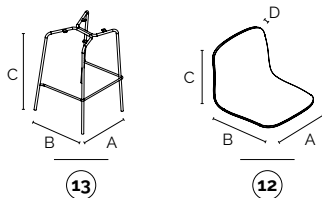
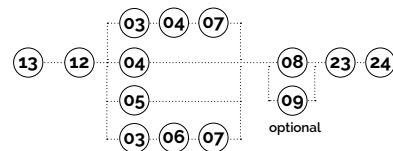
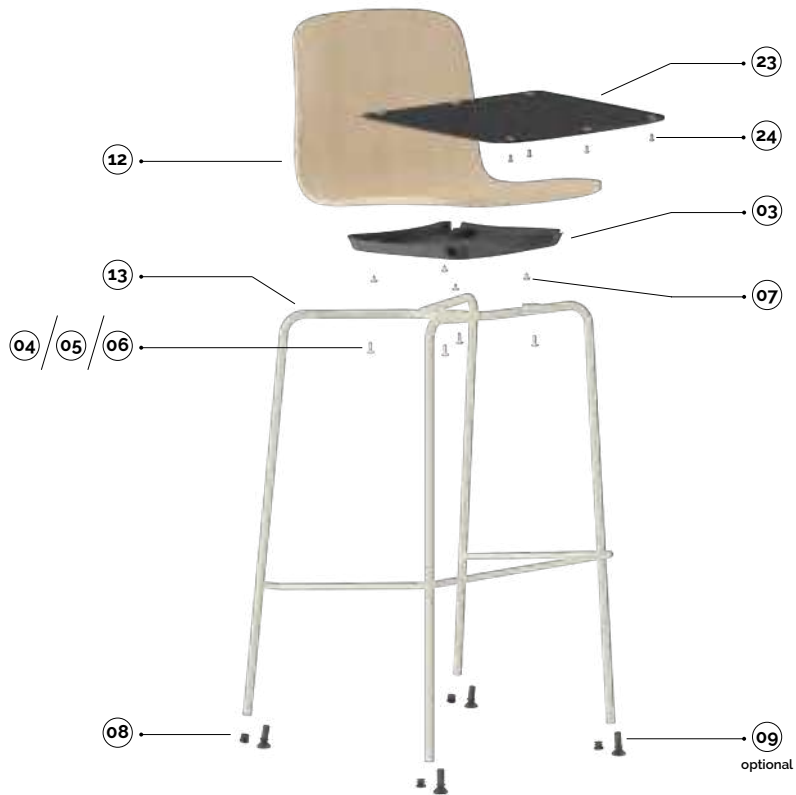

main component sizes

13 xylo - telaio sgabello h.750 d.16 senza tappi xylo - stool frames h.750 d.16 without caps

code	finishing	q.kit	q.pack	a	b	c	kg.x1	vol.x1
110603-666	● nero/black	x1	50	490	480	740	3,90	mc. 0.08
110605-666	● avorio/ivory	x1	50	490	480	740	3,90	mc. 0.08
110610-666	● cromato/chrome	x1	50	490	480	740	3,90	mc. 0.08

12 xylo - scocca in legno per telaio sgabello xylo - plywood shell for stool frame

code	finishing	q.kit	q.pack	a	b	c	d	kg.x1	vol.x1
123907-005	● faggio/beech wood	x1	5	410	420	340	12	2,30	mc. 0.0312
123907-007	● rovere/oak wood	x1	5	410	420	340	12	2,30	mc. 0.0312
123901-001	● grezza da tappezzare/upholsterable version	x1	5	410	420	340	12	2,30	mc. 0.0312

03 xylo - copertina in plastica xylo - plastic cover

code	finishing	q.kit	q.pack	a	b	c	kg.x1	vol.x1
132203-043	● nero/black	x1	10	260	310	30	0,25	mc. 0.0025
132205-040	● avorio/ivory	x1						

04 xylo - vite m6x16 per fissaggio scocca faggio/rovere con copertina o per fissaggio scocca da tappezzare senza copertina xylo - m6x16 screw for fixing beech/oak shell with cover or for fixing upholsterable shell without cover

code	finishing	q.kit
117711-185	○ zincat bianca/white zinc	x4

05 xylo - vite TBEI m6x10 per fissaggio scocca faggio/rovere senza copertina xylo - TBEI screw m6x10 for fixing beech/oak shell without cover

code	finishing	q.kit
117711-540	○ zincat bianca/white zinc	x4

06 xylo - vite TBEI 10 g M6x20 per fissaggio scocca da tappezzare con copertina xylo - TBEI screw 10.g fm6x20 for fixing upholsterable shell with cover

code	finishing	q.kit
117711-211	○ zincat bianca/white zinc	x4

23 xylo - pannello sedile in plastica con 6 borchie xylo - plastic seat panel with 6 upholstery nails

code	finishing	q.kit	a	b	c	kg.x1
132203-095	● nero/black	x1	413	387	4	0,60

24 xylo - viti per il fissaggio del pannello xylo - screws for panel fixing

code	finishing	q.kit
117711-120	○ zincat bianca/white zinc	x6

for the components below, see previous page

07 08 09

xylo

slide

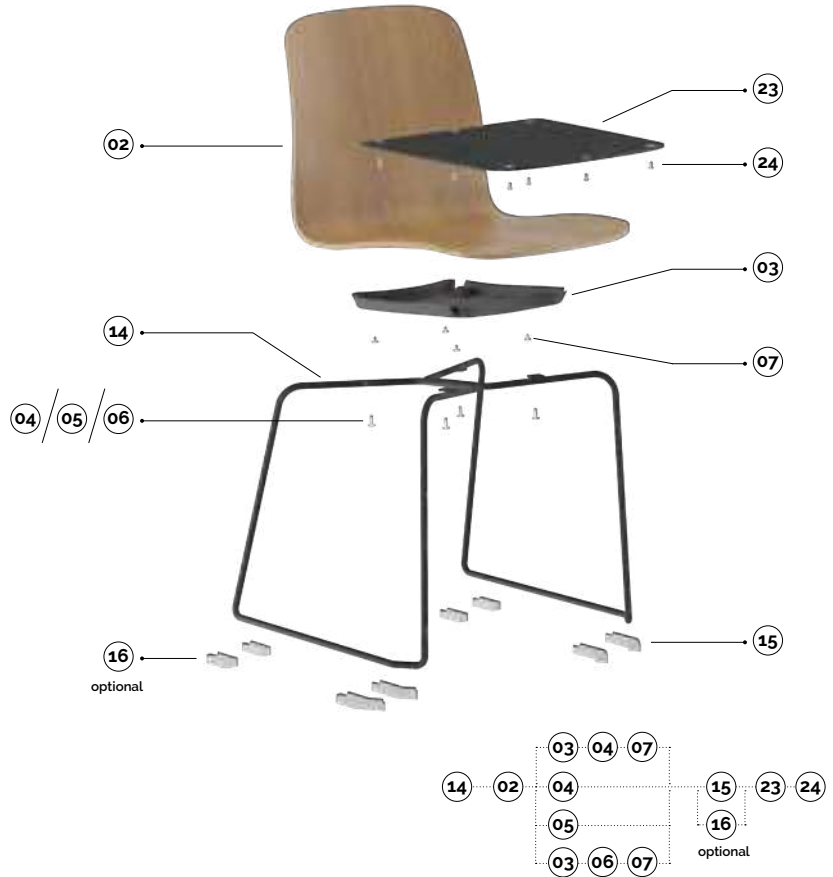
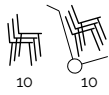

14 xylo - telaio a slitta in tondino d.12
xylo - slide wire frame d.12

code	finishing	q.kit	q.pack	a	b	c	kg.x1	vol.x1
110503-549	● nero/black	x1	100	555	495	455	3,70	mc.0.03
110505-549	● avorio/ivory	ral 1013	x1	100	555	495	455	3,70
110510-549	● cromato/chrome	x1	100	555	495	455	3,70	mc.0.03

02 xylo - scocca in legno per telaio 4 gambe/slitta/base fissa 4 razze/panca
xylo - plywood shell for 4-legs/slide/4 star fixed base/bench frames

code	finishing	q.kit	q.pack	a	b	c	d	kg.x1	vol.x1
123907-004	● faggio/beech wood	x1	5	440	510	410	12	3,00	mc. 0.0312
123907-006	● rovere/oak wood	x1	5	440	510	410	12	3,00	mc. 0.0312
123901-000	● grezza da tappezzare/upholsterable version	x1	5	440	510	410	12	3,00	mc. 0.0312

03 xylo - copertina in plastica
xylo - plastic cover

code	finishing	q.kit	q.pack	a	b	c	kg.x1	vol.x1
132203-043	● nero/black	ral 9005	x1	10	260	310	30	0,25
132205-040	● avorio/ivory	ral 1013	x1					

04 xylo - vite m6x16 per fissaggio scocca faggio/rovere con copertina o per fissaggio scocca da tappezzare senza copertina
xylo - m6x16 screw for fixing beech/oak shell with cover or for fixing upholsterable shell without cover

code	finishing	q.kit
117711-185	○ zincat bianca/white zinc	x4

05 xylo - vite TBEI m6x10 per fissaggio scocca faggio/rovere senza copertina
xylo - TBEI screw m6x10 for fixing beech/oak shell without cover

code	finishing	q.kit
117711-540	○ zincat bianca/white zinc	x4

06 xylo - vite TBEI 10.9 M6x20 per fissaggio scocca da tappezzare con copertina
xylo - TBEI screw 10.9 fm6x20 for fixing upholsterable shell with cover

code	finishing	q.kit
117711-211	○ zincat bianca/white zinc	x4

07 xylo - paracolpi in PVC con testa bombata
xylo - PVC buffer with round head

code	finishing	q.kit
134406-000	○ neutro/neutral	x4

15 xylo - btf-kit piedini
xylo - btf-kit feet

code	finishing	q.kit	q.pack
134306-001	○ neutro/neutral	x1	100

16 xylo - btfa-kit piedini con ganci
xylo - btfa-kit feet with hooks

code	finishing	q.kit	q.pack
134306-002	○ neutro/neutral	x1	100

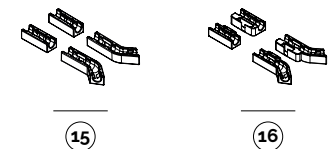
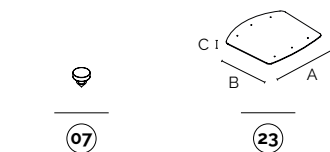
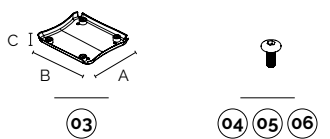
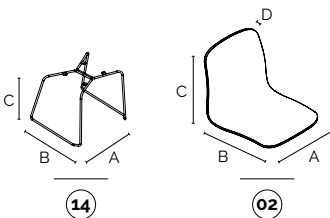

main component sizes

for the components below, see next page

23 **24**

xylo

4-spoke base

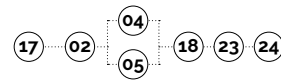
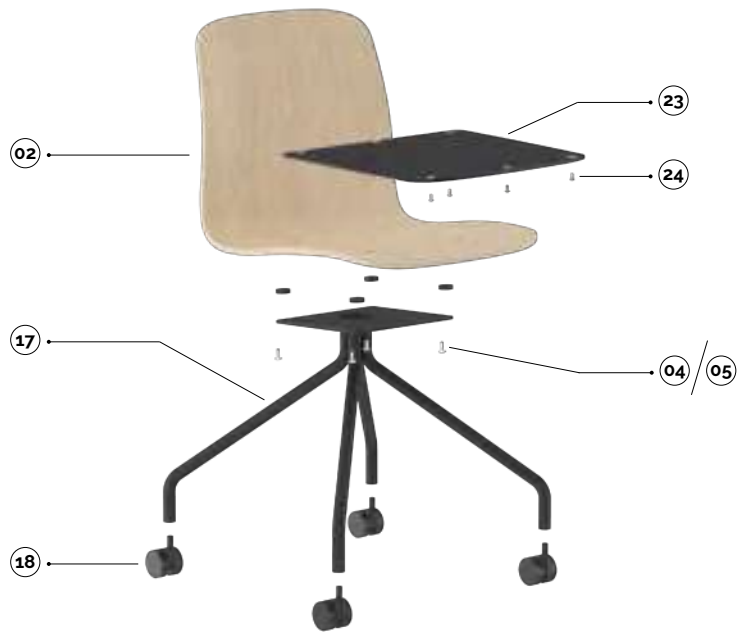

main component sizes

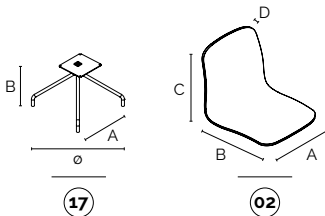

17

02

04 05

18

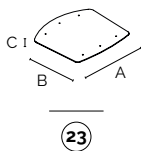

23

17 xylo - base fissa a 4 razze con riduttori per ruote + distanziatori
xylo - 4-spoke fixed base with adapter for castors + spacers

code	finishing	q.kit	q.pack	ø	a	b	kg.x1	vol.x1
110203-165	● nero/black	x1	30	680	490	380	4,00	mc. 0.1
110205-165	● avorio/ivory ral 1013	x1	30	680	490	380	4,00	mc. 0.1
110210-165	● cromato/chrome	x1	30	680	490	380	4,00	mc. 0.1

02 xylo - scocca in legno per telaio 4 gambe/slitta/base fissa 4 razze/panca
xylo - plywood shell for 4-legs/slide/4 star fixed base/bench frames

code	finishing	q.kit	q.pack	a	b	c	d	kg.x1	vol.x1
123907-004	● faggio/beech wood	x1	5	440	510	410	12	3,00	mc. 0.0312
123907-006	● rovere/oak wood	x1	5	440	510	410	12	3,00	mc. 0.0312
123901-000	● grezza da tappezzare/upholsterable version	x1	5	440	510	410	12	3,00	mc. 0.0312

04 xylo - vite m6x16 per fissaggio scocca faggio/rovere con copertina o per fissaggio scocca da tappezzare senza copertina
xylo - m6x16 screw for fixing beech/oak shell with cover or for fixing upholsterable shell without cover

code	finishing	q.kit
117711-185	○ zincat bianca/white zinc	x4

05 xylo - vite TBEI m6x10 per fissaggio scocca faggio/rovere senza copertina
xylo - TBEI screw m6x10 for fixing beech/oak shell without cover

code	finishing	q.kit
117711-540	○ zincat bianca/white zinc	x4

18 doppia ruota d.50 in desmopan con perno montato
twin wheel castor d.50 desmopan with pivot mounted

code	finishing	q.kit	kg.x1
134403-003	● nero/black	x4	0,05

23 xylo - pannello sedile in plastica con 6 borchie
xylo - plastic seat panel with 6 upholstery nails

code	finishing	q.kit	a	b	c	kg.x1
132203-095	● nero/black	x1	413	387	4	0,60

24 xylo - viti per il fissaggio del pannello
xylo - screws for panel fixing

code	finishing	q.kit
117711-120	○ zincat bianca/white zinc	x6

xylo

bench

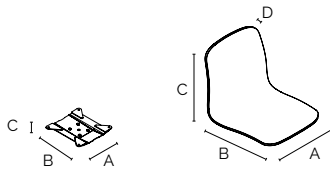
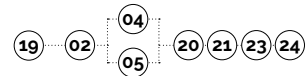
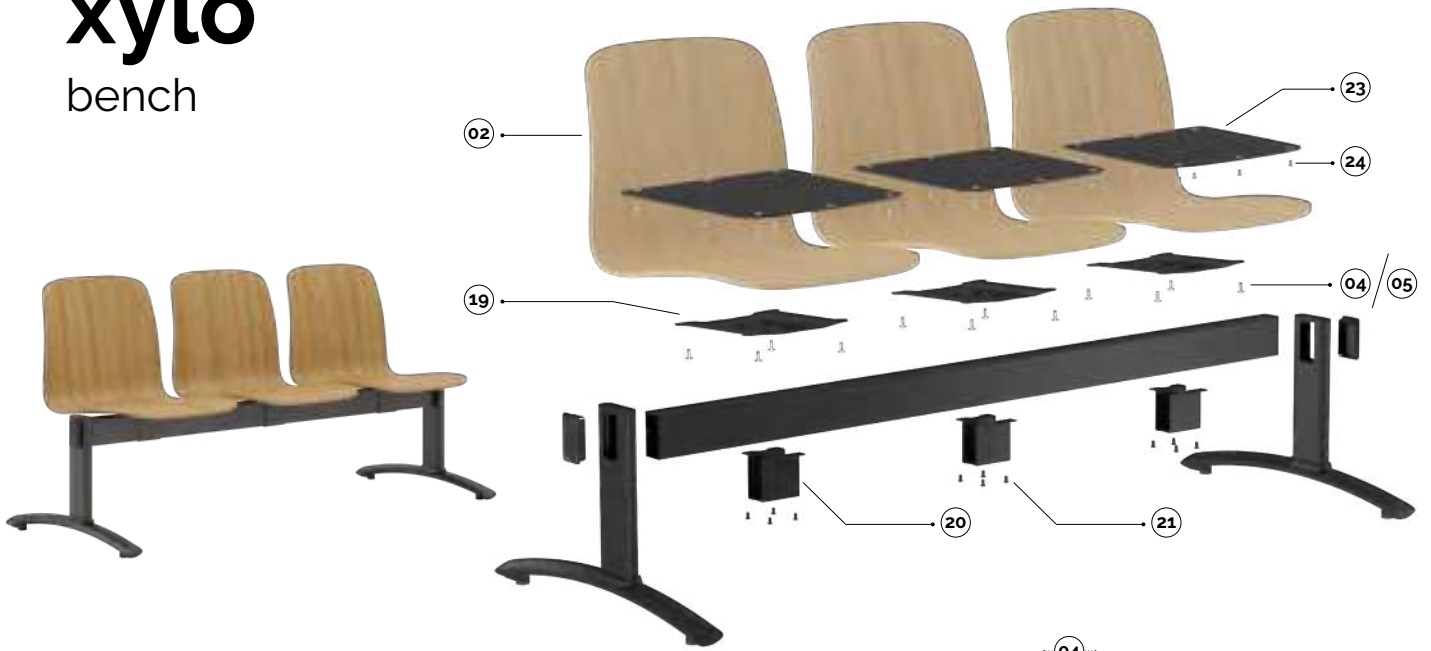

19

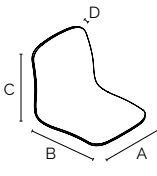

02



04 05

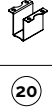

20



21

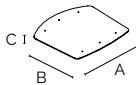

23

19 xylo - telaio panca verniciata
xylo - frame for bench paint

code	finishing	q.kit	q.pack	a	b	c	kg.x1	vol.x1
110703-606	● nero/black	x1	10	225	225	20	1,05	mc. 0,002

02 xylo - scocca in legno per telaio 4 gambe/slitta/base fissa 4 razze/panca
xylo - plywood shell for 4-legs/slide/4 star fixed base/bench frames

code	finishing	q.kit	q.pack	a	b	c	d	kg.x1	vol.x1
123907-004	● faggio/beech wood	x1	5	440	510	410	12	3,00	mc. 0,0312
123907-006	● rovere/oak wood	x1	5	440	510	410	12	3,00	mc. 0,0312
123901-000	● grezza da tappezzare/upholsterable version	x1	5	440	510	410	12	3,00	mc. 0,0312

04 xylo - vite m6x16 per fissaggio scocca faggio/rovere con copertina o per fissaggio scocca da tappezzare senza copertina
xylo - m6x16 screw for fixing beech/oak shell with cover or for fixing upholsterable shell without cover

code	finishing	q.kit
117711-185	○ zincat bianca/white zinc	x4

05 xylo - vite TBEI m6x10 per fissaggio scocca faggio/rovere senza copertina
xylo - TBEI screw m6x10 for fixing beech/oak shell without cover

code	finishing	q.kit
117711-540	○ zincat bianca/white zinc	x4

20 xylo - cavallotto sotto trave
xylo - under beam support

code	finishing	q.kit	q.pack	a	b	kg.x1	vol.x1
110703-007	● nero/black	x1	50	55	65	0,60	mc. 0,0005

21 xylo - confezione viti M8x12 a testa cilindrica e esagono incassato
xylo - M8x12 hexagon socket head screws set

code	finishing	q.kit	q.pack
117003-070	● nero/black	x4	200

23 xylo - pannello sedile in plastica con 6 borchie
xylo - plastic seat panel with 6 upholstery nails

code	finishing	q.kit	a	b	c	kg.x1
132203-095	● nero/black	x1	413	387	4	0,60

24 xylo - viti per il fissaggio del pannello
xylo - screws for panel fixing

code	finishing	q.kit
117711-120	○ zincat bianca/white zinc	x6

for the bench components, see page 417

main component sizes

optionals

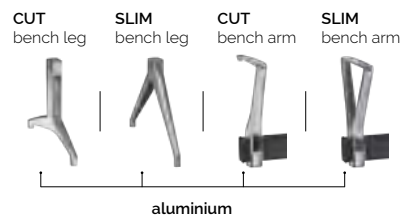
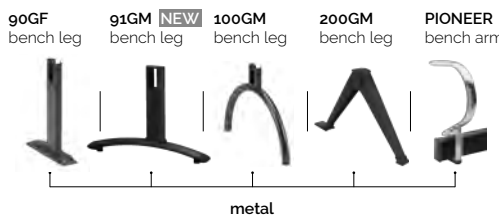





jota



discover more about
Jota Collection

Una collezione di sedute pratica e compatta, ideale per il settore contract, ma non solo. Jota comprende una sedia, disponibile con o senza braccioli, e uno sgabello, entrambi caratterizzati da un design distintivo e contemporaneo. Il linguaggio di Jota si adatta facilmente a qualsiasi tipo di ambiente grazie alla varietà di finiture e alla gamma di colori disponibili. Le scocche, sia per la sedia che per lo sgabello, sono realizzate in tecnopolimero, disponibile in 4 colori, o in Bio-Lolla. Inoltre, è possibile tappezzare le scocche del sedile e l'apposito pannello dello schienale per ottenere una maggiore personalizzazione.

A collection of practical and compact seatings, ideal for the contract sector, but not only. Jota includes a chair, available with or without armrests, and a stool, both featuring a distinctive and contemporary design.

Jota's language easily adapts to any type of environment thanks to the variety of finishes and range of colors available. The shells, for both chair and stool, are made of technopolymer, available in 4 colors, or Bio-Lolla. In addition, it is possible to upholster the seat and the dedicated backrest panel to achieve greater customization.

Plus

- Disponibile nelle versioni sedia, sedia con braccioli e sgabello.
- Possibilità di tappezzare sedile ed apposito pannello per schienale.
- Scocche sedile e schienale in materiale riciclato a base di lolla di riso (Bio-Lolla).
- Available in chair, chair with armrests and stool versions.
- Possibility of upholstering seat and dedicated backrest panel.
- Seat and backrest shells made of recycled rice husk-based material (Bio-Lolla).



designed by:
Studio Irvine

jota

4-legs

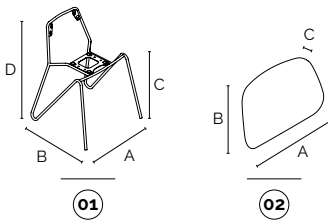
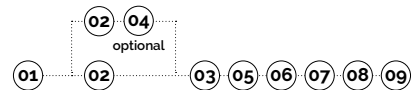
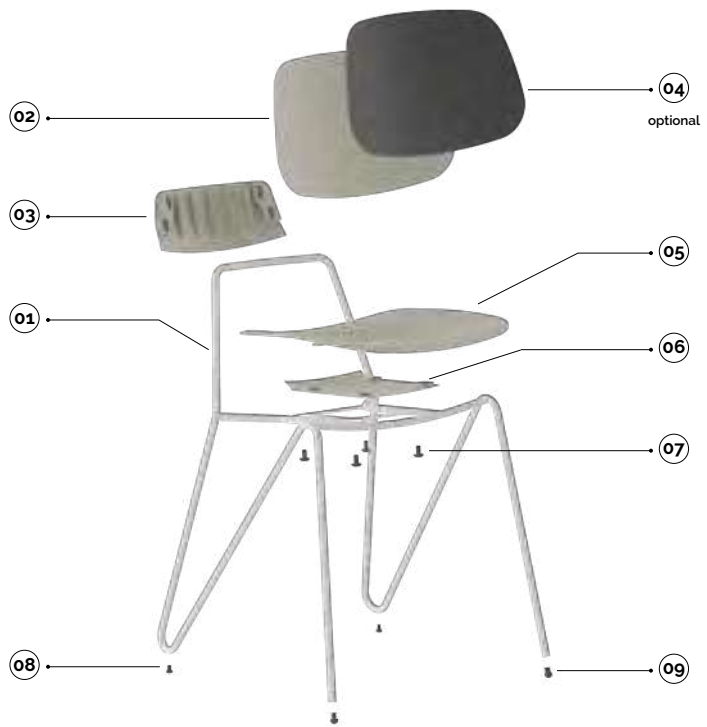

01

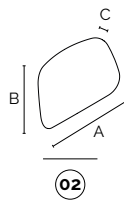

02

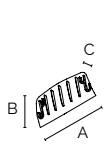

03

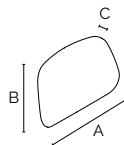

04

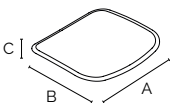

05

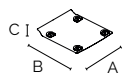

06



07



08



09

01 jota sedia - telaio a 4 gambe in metallo jota chair - 4-legs metal frame

code	finishing	q.kit	q.pack	a	b	c	d	kg.x1	vol.x1
A110103-072	● nero/black	x1	40	500	500	458	680	3,25	/
A110105-072	● bianco/white	x1	40	500	500	458	680	3,25	/
A110110-072	● cromato/chrome	x1	40	500	500	458	680	3,25	/

02 jota sedia & sgabello - schienale in tecnopolimero jota chair & stool - technopolymer backrest

code	finishing	q.kit	q.pack	a	b	c	kg.x1	vol.x1
A132103-000	● nero/black	x1	30	400	260	6,5	0,60	mc. 0.0031
A132104-000	● grigio/grey	x1	30	400	260	6,5	0,60	mc. 0.0031
A132102-000	● rosso/red	x1	30	400	260	6,5	0,60	mc. 0.0031
A132116-000	● verde/green	x1	30	400	260	6,5	0,60	mc. 0.0031
A132107-000	● bio-lolla/bio-husk	x1	30	400	260	6,5	0,60	mc. 0.0031

03 jota sedia & sgabello - copertina schienale in tecnopolimero jota chair & stool - backrest technopolymer cover

code	finishing	q.kit	q.pack	a	b	c	kg.x1	vol.x1
A132103-001	● nero/black	x1	60	285	120	3	0,09	mc. 0.00055
A132104-001	● grigio/grey	x1	60	285	120	3	0,09	mc. 0.00055
A132102-001	● rosso/red	x1	60	285	120	3	0,09	mc. 0.00055
A132116-001	● verde/green	x1	60	285	120	3	0,09	mc. 0.00055
A132107-001	● bio-lolla/bio-husk	x1	60	285	120	3	0,09	mc. 0.00055

04 jota sedia & sgabello - pannellino per schienale in plastica tappezzabile jota chair & stool - upholsterable plastic backrest panel

code	finishing	q.kit	q.pack	a	b	c	kg.x1	vol.x1
A132103-003	● nero/black	x1	30	395	255	5	0,40	mc. 0.0031

05 jota sedia & sgabello - sedile in tecnopolimero tappezzabile jota chair & stool - technopolymer seat upholsterable

code	finishing	q.kit	q.pack	a	b	c	kg.x1	vol.x1
A132203-000	● nero/black	x1	20	400	380	8	0,95	mc. 0.0047
A132204-002	● grigio/grey	x1	20	400	380	8	0,95	mc. 0.0047
A132202-000	● rosso/red	x1	20	400	380	8	0,95	mc. 0.0047
A132216-000	● verde/green	x1	20	400	380	8	0,95	mc. 0.0047
A132207-000	● bio-lolla/bio-husk	x1	20	400	380	8	0,95	mc. 0.0047

06 jota sedia & sgabello - copertina sedile in tecnopolimero jota chair & stool - seat technopolymer cover

code	finishing	q.kit	q.pack	a	b	c	kg.x1	vol.x1
A132203-001	● nero/black	x1	40	185	215	3	0,10	mc. 0.0008
A132204-001	● grigio/grey	x1	40	185	215	3	0,10	mc. 0.0008
A132202-001	● rosso/red	x1	40	185	215	3	0,10	mc. 0.0008
A132216-001	● verde/green	x1	40	185	215	3	0,10	mc. 0.0008
A132207-001	● bio-lolla/bio-husk	x1	40	185	215	3	0,10	mc. 0.0008

07 jota sedia & sgabello - PF2 - paracolpi a testa bombata in polietilene jota chair & stool - PF2 - polyethylene round-head buffer

code	finishing	q.kit
134403-101	● nero/black	x4

08 jota sedia & sgabello - T114 - puntale alettato a testa sferica - d.14 jota chair & stool - T114 - ribbed spherical head insert - d.14

code	finishing	q.kit
134203-140	● nero/black	x2

09 jota sedia - IRA - Puntale alettato in polietilene - d.12 jota chair - IRA - Polyethylene ribbed insert - d.12

code	finishing	q.kit
134203-030	● nero/black	x2

main component sizes

jota

4-legs w/armrests

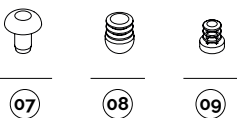
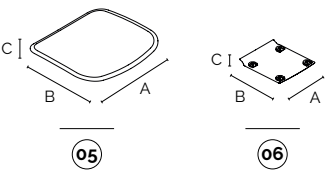
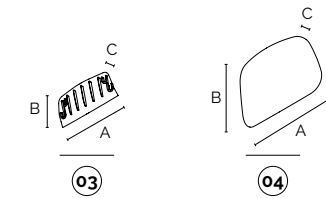
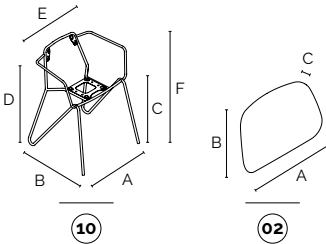
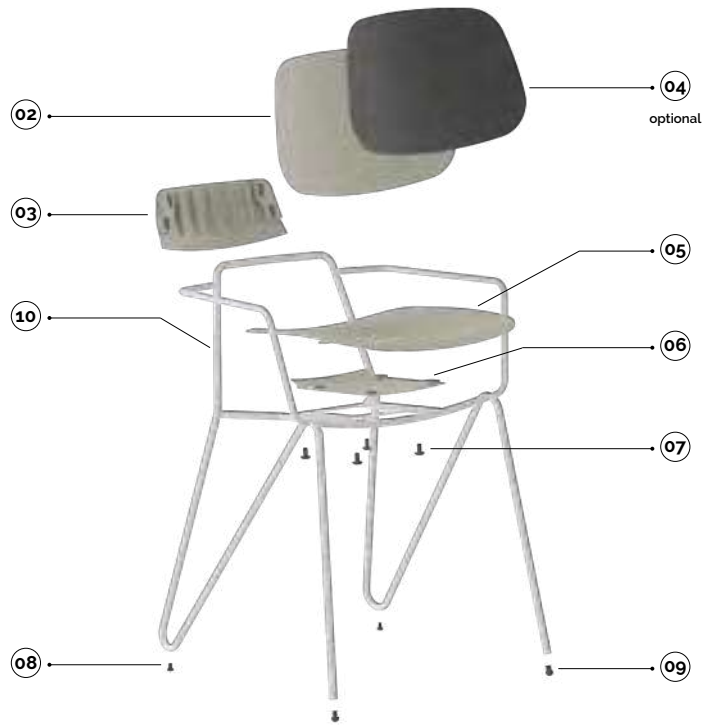

main component sizes

10 jota sedia - telaio a 4 gambe in metallo con braccioli
jota chair - 4-legs metal frame with armrests

code	finishing	q.kit	q.pack	a	b	c	d	e	f	kg.x1	vol.x1
A110103-075	● nero/black	x1	30/40	500	500	458	649	540	680	4.17	/
A110105-075	● bianco/white	x1	30/40	500	500	458	649	540	680	4.17	/
A110110-075	● cromato/chrome	x1	30/40	500	500	458	649	540	680	4.17	/

02 jota sedia & sgabello - schienale in tecnopolimero
jota chair & stool - technopolymer backrest

code	finishing	q.kit	q.pack	a	b	c	kg.x1	vol.x1
A132103-000	● nero/black	x1	30	400	260	6,5	0,60	mc. 0.0031
A132104-000	● grigio/grey	x1	30	400	260	6,5	0,60	mc. 0.0031
A132102-000	● rosso/red	x1	30	400	260	6,5	0,60	mc. 0.0031
A132116-000	● verde/green	x1	30	400	260	6,5	0,60	mc. 0.0031
A132107-000	● bio-lolla/bio-husk	x1	30	400	260	6,5	0,60	mc. 0.0031

03 jota sedia & sgabello - copertina schienale in tecnopolimero
jota chair & stool - backrest technopolymer cover

code	finishing	q.kit	q.pack	a	b	c	kg.x1	vol.x1
A132103-001	● nero/black	x1	60	285	120	3	0,09	mc. 0.00055
A132104-001	● grigio/grey	x1	60	285	120	3	0,09	mc. 0.00055
A132102-001	● rosso/red	x1	60	285	120	3	0,09	mc. 0.00055
A132116-001	● verde/green	x1	60	285	120	3	0,09	mc. 0.00055
A132107-001	● bio-lolla/bio-husk	x1	60	285	120	3	0,09	mc. 0.00055

04 jota sedia & sgabello - pannello per schienale in plastica tappezziabile
jota chair & stool - upholsterable plastic backrest panel

code	finishing	q.kit	q.pack	a	b	c	kg.x1	vol.x1
A132103-003	● nero/black	x1	30	395	255	5	0,40	mc. 0.0031

05 jota sedia & sgabello - sedile in tecnopolimero tappezziabile
jota chair & stool - technopolymer seat upholsterable

code	finishing	q.kit	q.pack	a	b	c	kg.x1	vol.x1
A132203-000	● nero/black	x1	20	400	380	8	0,95	mc. 0.0047
A132204-002	● grigio/grey	x1	20	400	380	8	0,95	mc. 0.0047
A132202-000	● rosso/red	x1	20	400	380	8	0,95	mc. 0.0047
A132216-000	● verde/green	x1	20	400	380	8	0,95	mc. 0.0047
A132207-000	● bio-lolla/bio-husk	x1	20	400	380	8	0,95	mc. 0.0047

06 jota sedia & sgabello - copertina sedile in tecnopolimero
jota chair & stool - seat technopolymer cover

code	finishing	q.kit	q.pack	a	b	c	kg.x1	vol.x1
A132203-001	● nero/black	x1	40	185	215	3	0,10	mc. 0.0008
A132204-001	● grigio/grey	x1	40	185	215	3	0,10	mc. 0.0008
A132202-001	● rosso/red	x1	40	185	215	3	0,10	mc. 0.0008
A132216-001	● verde/green	x1	40	185	215	3	0,10	mc. 0.0008
A132207-001	● bio-lolla/bio-husk	x1	40	185	215	3	0,10	mc. 0.0008

07 jota sedia & sgabello - PF2 - paracolpi a testa bombata in polietilene
jota chair & stool - PF2 - polyethylene round-head buffer

code	finishing	q.kit
134403-101	● nero/black	x4

08 jota sedia & sgabello - T114 - puntale alettato a testa sferica - d.14
jota chair & stool - T114 - ribbed spherical head insert - d.14

code	finishing	q.kit
134203-140	● nero/black	x2

09 jota sedia - IRA - Puntale alettato in polietilene - d.12
jota chair - IRA - Polyethylene ribbed insert - d.12

code	finishing	q.kit
134203-030	● nero/black	x2

jota

stool h.650

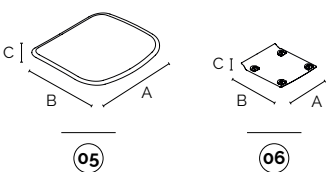
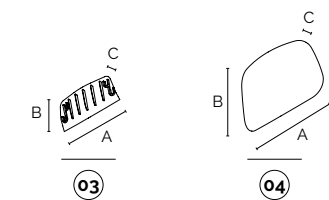
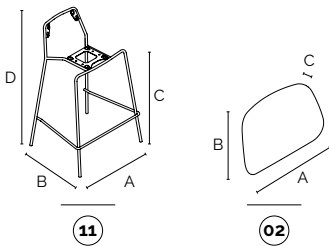
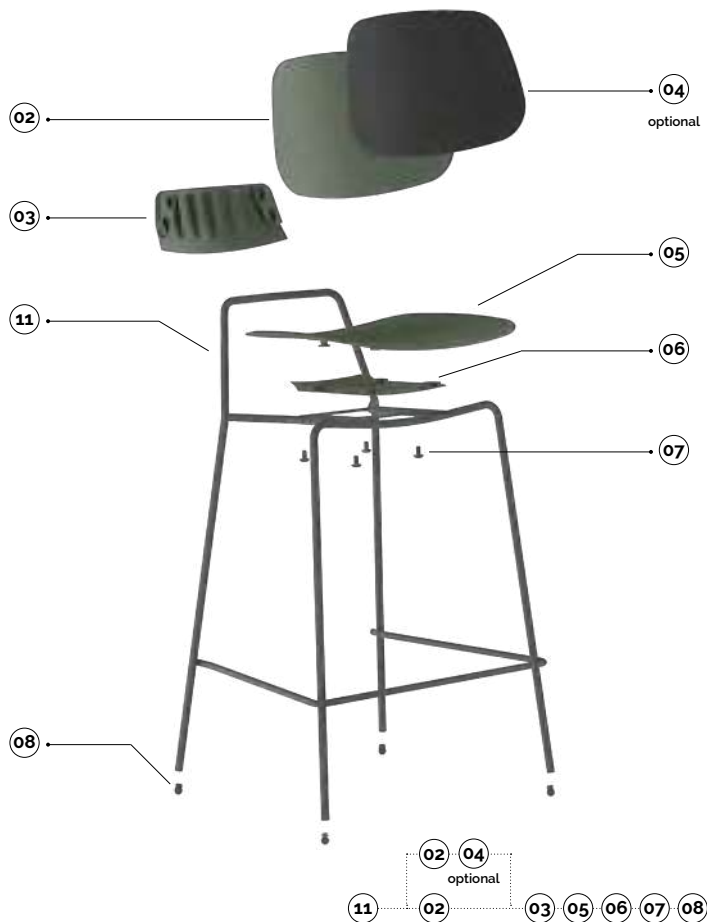

11 jota sgabello basso - telaio a 4 gambe in metallo - h.650
jota low stool - 4-legs metal frame - h.650

code	finishing	q.kit	q.pack	a	b	c	d	kg.x1	vol.x1
A110603-034	● nero/black	x1	20/30	530	470	640	830	3,95	/
A110605-034	● bianco/white	x1	20/30	530	470	640	830	3,95	/
A110610-034	● cromato/chrome	x1	20/30	530	470	640	830	3,95	/

02 jota sedia & sgabello - schienale in tecnopolimero
jota chair & stool - technopolymer backrest

code	finishing	q.kit	q.pack	a	b	c	kg.x1	vol.x1
A132103-000	● nero/black	x1	30	400	260	6,5	0,60	mc. 0.00031
A132104-000	● grigio/grey	x1	30	400	260	6,5	0,60	mc. 0.00031
A132102-000	● rosso/red	x1	30	400	260	6,5	0,60	mc. 0.00031
A132116-000	● verde/green	x1	30	400	260	6,5	0,60	mc. 0.00031
A132107-000	● bio-lolla/bio-husk	x1	30	400	260	6,5	0,60	mc. 0.00031

03 jota sedia & sgabello - copertina schienale in tecnopolimero
jota chair & stool - backrest technopolymer cover

code	finishing	q.kit	q.pack	a	b	c	kg.x1	vol.x1
A132103-001	● nero/black	x1	60	285	120	3	0,09	mc. 0.00055
A132104-001	● grigio/grey	x1	60	285	120	3	0,09	mc. 0.00055
A132102-001	● rosso/red	x1	60	285	120	3	0,09	mc. 0.00055
A132116-001	● verde/green	x1	60	285	120	3	0,09	mc. 0.00055
A132107-001	● bio-lolla/bio-husk	x1	60	285	120	3	0,09	mc. 0.00055

04 jota sedia & sgabello - pannello per schienale in plastica tappezziabile
jota chair & stool - upholsterable plastic backrest panel

code	finishing	q.kit	q.pack	a	b	c	kg.x1	vol.x1
A132103-003	● nero/black	x1	30	395	255	5	0,40	mc. 0.00031

05 jota sedia & sgabello - sedile in tecnopolimero tappezziabile
jota chair & stool - technopolymer seat upholsterable

code	finishing	q.kit	q.pack	a	b	c	kg.x1	vol.x1
A132203-000	● nero/black	x1	20	400	380	8	0,95	mc. 0.00047
A132204-002	● grigio/grey	x1	20	400	380	8	0,95	mc. 0.00047
A132202-000	● rosso/red	x1	20	400	380	8	0,95	mc. 0.00047
A132216-000	● verde/green	x1	20	400	380	8	0,95	mc. 0.00047
A132207-000	● bio-lolla/bio-husk	x1	20	400	380	8	0,95	mc. 0.00047

06 jota sedia & sgabello - copertina sedile in tecnopolimero
jota chair & stool - seat technopolymer cover

code	finishing	q.kit	q.pack	a	b	c	kg.x1	vol.x1
A132203-001	● nero/black	x1	40	185	215	3	0,10	mc. 0.00008
A132204-001	● grigio/grey	x1	40	185	215	3	0,10	mc. 0.00008
A132202-001	● rosso/red	x1	40	185	215	3	0,10	mc. 0.00008
A132216-001	● verde/green	x1	40	185	215	3	0,10	mc. 0.00008
A132207-001	● bio-lolla/bio-husk	x1	40	185	215	3	0,10	mc. 0.00008

07 jota sedia & sgabello - PF2 - paracolpi a testa bombata in polietilene
jota chair & stool - PF2 - polyethylene round-head buffer

code	finishing	q.kit
134403-101	● nero/black	x4

08 jota sedia & sgabello - T114 - puntale alettato a testa sferica - d.14
jota chair & stool - T114 - ribbed spherical head insert - d.14

code	finishing	q.kit
134203-140	● nero/black	x4

main component sizes

jota

stool h.750

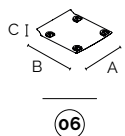
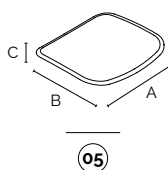
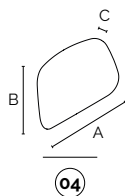
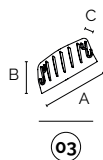
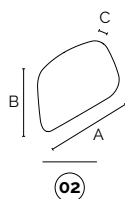
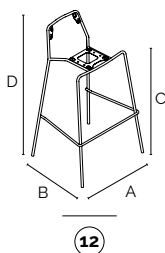
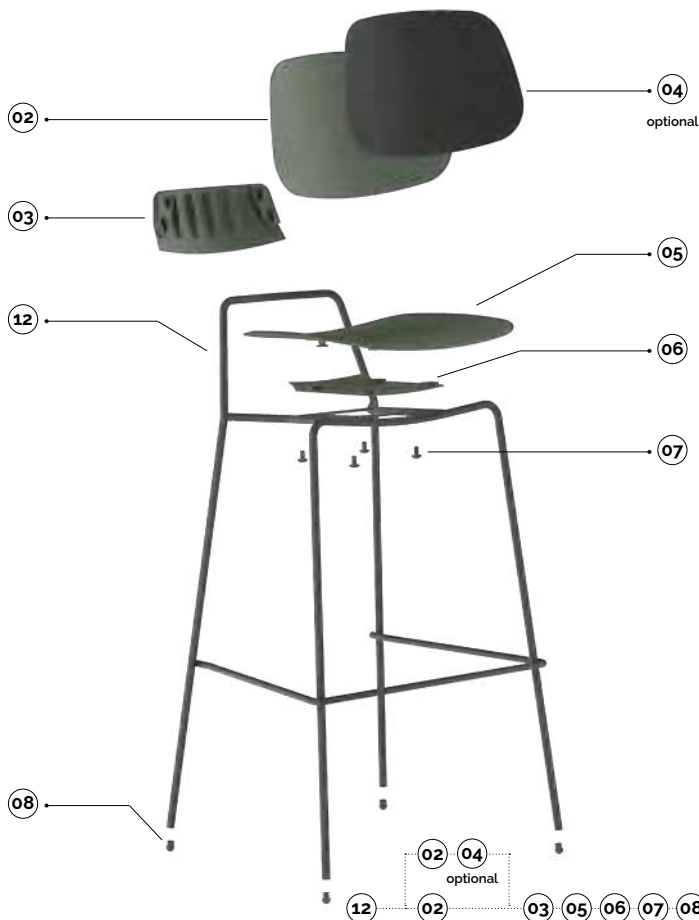

main component sizes

12 jota sgabello alto - telaio a 4 gambe in metallo - h.750
jota high stool - 4-legs metal frame - h.750

code	finishing	q.kit	q.pack	a	b	c	d	kg.x1	vol.x1
A110603-039	● nero/black	x1	20/30	540	480	740	930	4.18	/
A110605-039	● bianco/white	x1	20/30	540	480	740	930	4.18	/
A110610-039	● cromato/chrome	x1	20/30	540	480	740	930	4.18	/

02 jota sedia & sgabello - schienale in tecnopolimero
jota chair & stool - technopolymer backrest

code	finishing	q.kit	q.pack	a	b	c	kg.x1	vol.x1
A132103-000	● nero/black	x1	30	400	260	6,5	0,60	mc. 0.0031
A132104-000	● grigio/grey	x1	30	400	260	6,5	0,60	mc. 0.0031
A132102-000	● rosso/red	x1	30	400	260	6,5	0,60	mc. 0.0031
A132116-000	● verde/green	x1	30	400	260	6,5	0,60	mc. 0.0031
A132107-000	● bio-lolla/bio-husk	x1	30	400	260	6,5	0,60	mc. 0.0031

03 jota sedia & sgabello - copertina schienale in tecnopolimero
jota chair & stool - backrest technopolymer cover

code	finishing	q.kit	q.pack	a	b	c	kg.x1	vol.x1
A132103-001	● nero/black	x1	60	285	120	3	0,09	mc. 0.00055
A132104-001	● grigio/grey	x1	60	285	120	3	0,09	mc. 0.00055
A132102-001	● rosso/red	x1	60	285	120	3	0,09	mc. 0.00055
A132116-001	● verde/green	x1	60	285	120	3	0,09	mc. 0.00055
A132107-001	● bio-lolla/bio-husk	x1	60	285	120	3	0,09	mc. 0.00055

04 jota sedia & sgabello - pannello per schienale in plastica tappezzabile
jota chair & stool - upholsterable plastic backrest panel

code	finishing	q.kit	q.pack	a	b	c	kg.x1	vol.x1
A132103-003	● nero/black	x1	30	395	255	5	0,40	mc. 0.0031

05 jota sedia & sgabello - sedile in tecnopolimero tappezzabile
jota chair & stool - technopolymer seat upholsterable

code	finishing	q.kit	q.pack	a	b	c	kg.x1	vol.x1
A132203-000	● nero/black	x1	20	400	380	8	0,95	mc. 0.0047
A132204-002	● grigio/grey	x1	20	400	380	8	0,95	mc. 0.0047
A132202-000	● rosso/red	x1	20	400	380	8	0,95	mc. 0.0047
A132216-000	● verde/green	x1	20	400	380	8	0,95	mc. 0.0047
A132207-000	● bio-lolla/bio-husk	x1	20	400	380	8	0,95	mc. 0.0047

06 jota sedia & sgabello - copertina sedile in tecnopolimero
jota chair & stool - seat technopolymer cover

code	finishing	q.kit	q.pack	a	b	c	kg.x1	vol.x1
A132203-001	● nero/black	x1	40	185	215	3	0,10	mc. 0.0008
A132204-001	● grigio/grey	x1	40	185	215	3	0,10	mc. 0.0008
A132202-001	● rosso/red	x1	40	185	215	3	0,10	mc. 0.0008
A132216-001	● verde/green	x1	40	185	215	3	0,10	mc. 0.0008
A132207-001	● bio-lolla/bio-husk	x1	40	185	215	3	0,10	mc. 0.0008

07 jota sedia & sgabello - PF2 - paracolpi a testa bombata in polietilene
jota chair & stool - PF2 - polyethylene round-head buffer

code	finishing	q.kit
134403-101	● nero/black	x4

08 jota sedia & sgabello - T114 - puntale alettato a testa sferica - d.14
jota chair & stool - T114 - ribbed spherical head insert - d.14

code	finishing	q.kit
134203-140	● nero/black	x4



maui



discover more about
Maui Collection

Maui è una completa e versatile collezione di sedute imbottite da tappezzare, adatte a spazi contract, ambienti residenziali e ricettivi.

Le poltroncine Maui sono disponibili in tre diverse tipologie di scocche in poliuretano: Dining, Lounge, Lounge Plus, tutte abbinabili a basi girevoli in alluminio o a slitta in tondino metallico. La collezione si completa con un versatile tavolino con base in metallo.

Le scocche sono fornite grezze, da tappezzare.

Maui is a complete and versatile soft seating collection to be upholstered, suitable for contract spaces, residential settings, and receptive environments. Maui armchairs are available in three different types of polyurethane shells: Dining, Lounge, Lounge Plus, all of which can be combined with aluminium swivel or metal rod sled bases.

The collection is rounded out with a versatile coffee table with a metal base.

Shells are supplied unfinished, to be upholstered.

Plus

- Ideale per contract e ambienti residenziali, ricettivi e domestici.
- 3 varianti: Dining, Lounge e Lounge Plus.
- Versatile coffee table da abbinare alle sedute.
- *Ideal for contract and residential, hospitality and home environments.*
- *3 variants: Dining, Lounge and Lounge Plus.*
- *Versatile coffee table to match the seats.*



designed by:
StudioPANG

maui

dining sled

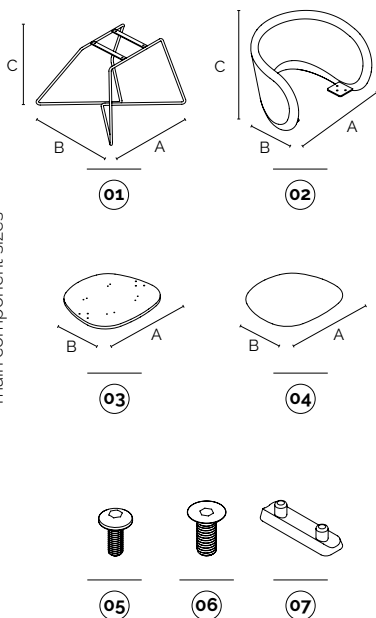
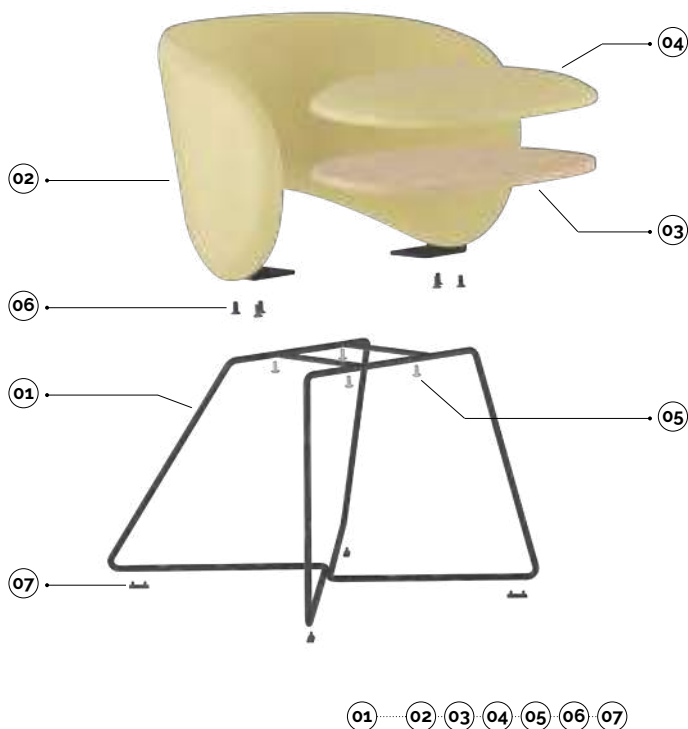

main component sizes

01 maui dining - telaio a slitta ø12

maui dining - sled frame ø12

code	finishing	q.kit	q.pack	a	b	c	kg.x1	vol.x1
A113403-115	● nero/black	x1	/	560	540	410	3.95	/
A113405-115	● bianco/white	x1	/	560	540	410	3.95	/
113410-115	● cromato/chrome	x1	/	560	540	410	3.95	/

02 maui dining - scocca schienale

maui dining - backrest shell

code	finishing	q.kit	q.pack	a	b	c	kg.x1	vol.x1
A133908-008	∅ da tappezzare/to be upholstered	x1	/	590	490	400	8.00	/

03 maui dining - pannello in multistrato per sedile

maui dining - plywood seat panel

code	finishing	q.kit	q.pack	a	b	kg.x1	vol.x1
A123607-069	● pino/pinewood	x1	/	470	450	1.60	/

04 maui dining - cuscino per sedile

maui dining - seat cushion

code	finishing	q.kit	q.pack	a	b	kg.x1	vol.x1
A134001-006	∅ da tappezzare/to be upholstered	x1	/	470	450	0.332	/

05 telai a slitta - vite dentellata TBEI M6x16

sled frames - TBEI M6x16 knurkled screw

code	finishing	q.kit	q.pack
117711-185	● bianco zincato/zinc-plated white	x4	/

06 maui dining - lounge - lounge plus - vite con frenafletti TSPEI m8x20

maui dining - lounge - lounge plus - TSPEI m8x20 screw with threadlocking

code	finishing	q.kit	q.pack
117703-257	● nero brunito0/burnished black	x6	/

07 telai a slitta - piedino in plastica a due pioli

sled frames - two pins plastic glide

code	finishing	q.kit	q.pack
A134303-000	● nero/black	x4	/

maui

dining swivel

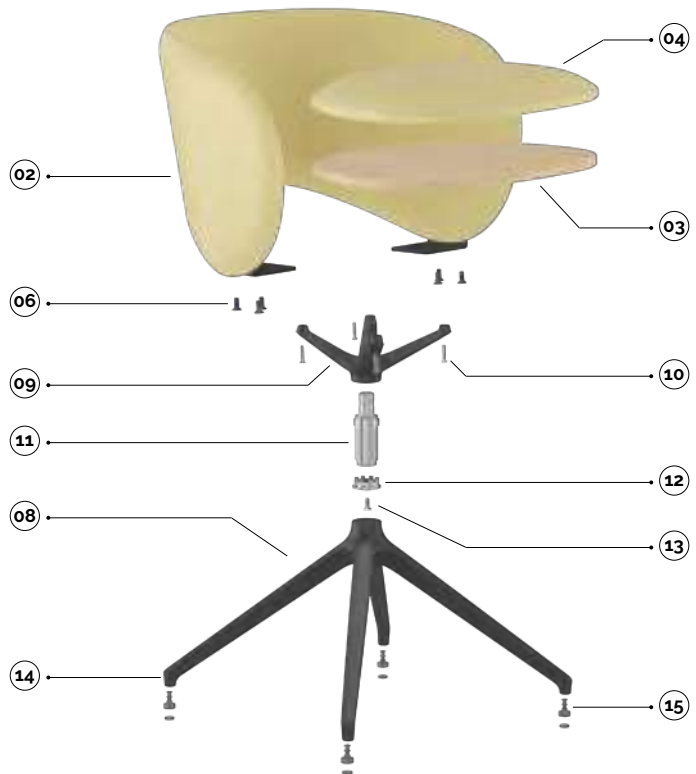

08 02 03 04 06 09 10 11 12 13 14 15

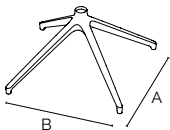

08

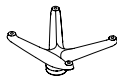

09



10



11



12



13



14



15

main component sizes

08 maui dining - base kylie in alluminio a 4 razze - ø720
maui dining - kylie 4-spokes aluminium base - ø720

code	finishing	q.kit	q.pack	a	b	kg.x1	vol.x1
A110203-100	● nero/black	x1	6	515	515	2,79	/
A110210-000	○ lucido/polished	x1	6	515	515	2,79	/

09 maui dining - supporto in alluminio per base kylie - ø720
maui dining - aluminium support for kylie base - ø720

code	finishing	q.kit	q.pack	kg.x1	vol.x1
A110203-103	● nero/black	x1	6	0,71	/
A110210-003	○ lucido/polished	x1	6	0,71	/

10 basi in alluminio a 4 razze kylie - vite TSP+ m6x30
kylie 4-spoke aluminium bases - TSP+ m6x30 screw

code	finishing	q.kit	q.pack
117711-192	● bianco zincato/zinc-plated white	x4	/

11 basi in alluminio a 4 razze kylie - adattatore in metallo
kylie 4-spoke aluminium bases - metal adapter

code	finishing	q.kit	q.pack	kg.x1
A110210-001	● zincato/zinc-plated	x1	6	/

12 basi in alluminio a 4 razze kylie - tappo sottobase
kylie 4-spoke aluminium bases - under-base cap

code	finishing	q.kit	q.pack	kg.x1
A110210-002	● grigio/grey	x1	6	/

13 basi in alluminio a 4 razze kylie - vite TSP+ m6x20
kylie 4-spoke aluminium bases - TSP+ m6x20 screw

code	finishing	q.kit	q.pack
117711-203	● bianco zincato/zinc-plated white	x1	6

14 basi in alluminio a 4 razze kylie - piedino in polipropilene
kylie 4-spoke aluminium bases - polypropylene glide

code	finishing	q.kit	q.pack	kg.x1
A110210-004	● grigio/grey	x4	24	/

15 basi in alluminio a 4 razze kylie - feltro per piedino in polipropilene
kylie 4-spoke aluminium bases - polypropylene glide felt

code	finishing	q.kit	q.pack
A110210-005	● nero/black	x4	24

for the components below, see previous page

02 03 04 06

maui

lounge sled

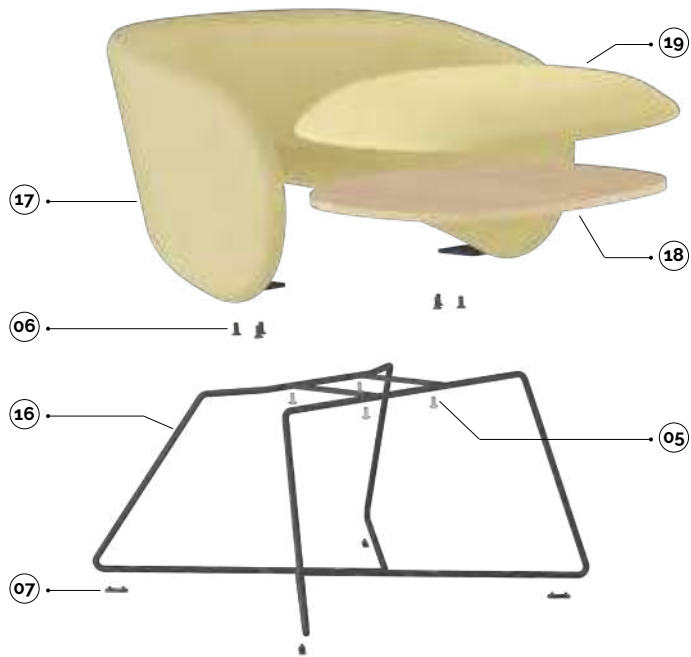

16 17 18 19 05 06 07

main component sizes

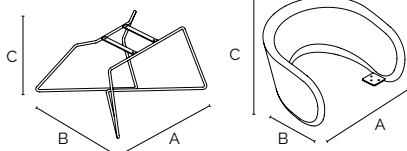

16

17

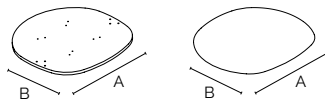

18

19

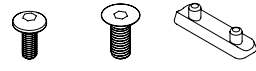

05

06

07

16 maui lounge - lounge plus - telaio a slitta - ø12 maui lounge - lounge plus - sled frame ø12

code	finishing	q.kit	q.pack	a	b	c	kg.x1	vol.x1
A113403-110	● nero/black	x1	/	650	610	360	4.30	/
A113405-110	● bianco/white	x1	/	650	610	360	4.30	/
113410-110	● cromato/chrome	x1	/	650	610	360	4.30	/

17 maui lounge - scocca schienale maui lounge - backrest shell

code	finishing	q.kit	q.pack	a	b	c	kg.x1	vol.x1
A133908-010	∅ da tappezzare/to be upholstered	x1	/	720	670	410	10.80	/

18 maui lounge - lounge plus - pannello in multistrato per sedile maui lounge - lounge plus - plywood seat panel

code	finishing	q.kit	q.pack	a	b	kg.x1	vol.x1
A123607-070	● pino/pinewood	x1	/	580	580	2.78	/

19 maui lounge - lounge plus - cuscino per sedile maui lounge - lounge plus - seat cushion

code	finishing	q.kit	q.pack	a	b	kg.x1	vol.x1
A134001-005	∅ da tappezzare/to be upholstered	x1	/	580	580	0.57	/

05 telai a slitta - vite dentellata TBEI M6x16 sled frames - TBEI M6x16 knurled screw

code	finishing	q.kit	q.pack
117711-185	● bianco zincato/zinc-plated white	x4	/

06 maui dining - lounge - lounge plus - vite con frenafletti TSPEI m8x20 maui dining - lounge - lounge plus - TSPEI m8x20 screw with threadlocking

code	finishing	q.kit	q.pack
117703-257	● nero brunito0/burnished black	x6	/

07 telai a slitta - piedino in plastica a due pioli sled frames - two pins plastic glide

code	finishing	q.kit	q.pack
A134303-000	● nero/black	x4	/

maui

lounge swivel

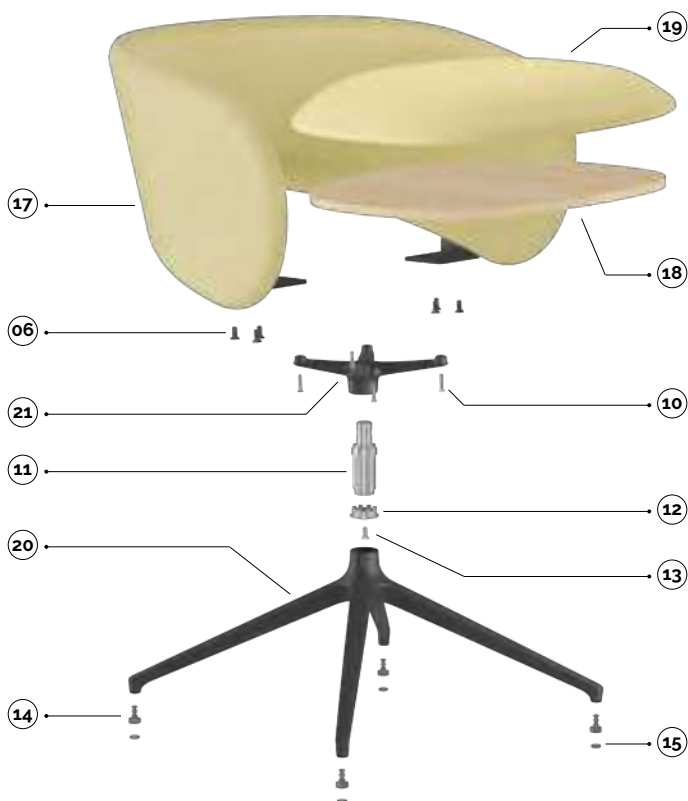

20 17 18 19 06 21 10 11 12 13 14 15

20 maui lounge - lounge plus - base kylie in alluminio a 4 razze - ø840
maui lounge - lounge plus - kylie 4-spokes aluminium base - ø840

code	finishing	q.kit	q.pack	a	b	kg.x1	vol.x1
A110203-101	● nero/black	x1	6	600	600	3.33	/
A110210-016	○ lucido/polished	x1	6	600	600	3.33	/

21 maui lounge - lounge plus - supporto in alluminio per base kylie - ø840
maui lounge - lounge plus - aluminium support for kylie base - ø840

code	finishing	q.kit	q.pack	kg.x1	vol.x1
A110203-104	● nero/black	x1	6	0.65	/
A110210-008	○ lucido/polished	x1	6	0.65	/

10 basi in alluminio a 4 razze kylie - vite TSP+ m6x30
kylie 4-spoke aluminium bases - TSP+ m6x30 screw

code	finishing	q.kit	q.pack
117711-192	● bianco zincato/zinc-plated white	x4	/

11 basi in alluminio a 4 razze kylie - adattatore in metallo
kylie 4-spoke aluminium bases - metal adapter

code	finishing	q.kit	q.pack	kg.x1
A110210-001	● zincato/zinc-plated	x1	6	/

12 basi in alluminio a 4 razze kylie - tappo sottobase
kylie 4-spoke aluminium bases - under-base cap

code	finishing	q.kit	q.pack	kg.x1
A110210-002	● grigio/grey	x1	6	/

13 basi in alluminio a 4 razze kylie - vite TSP+ m6x20
kylie 4-spoke aluminium bases - TSP+ m6x20 screw

code	finishing	q.kit	q.pack
117711-203	● bianco zincato/zinc-plated white	x1	6

14 basi in alluminio a 4 razze kylie - piedino in polipropilene
kylie 4-spoke aluminium bases - polypropylene glide

code	finishing	q.kit	q.pack	kg.x1
A110210-004	● grigio/grey	x4	24	/

15 basi in alluminio a 4 razze kylie - feltro per piedino in polipropilene
kylie 4-spoke aluminium bases - polypropylene glide felt

code	finishing	q.kit	q.pack
A110210-005	● nero/black	x4	24

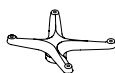
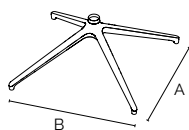

20

21



10

11



12

13



14

15

main component sizes

for the components below, see previous page

17 18 19 06

maui

lounge plus sled

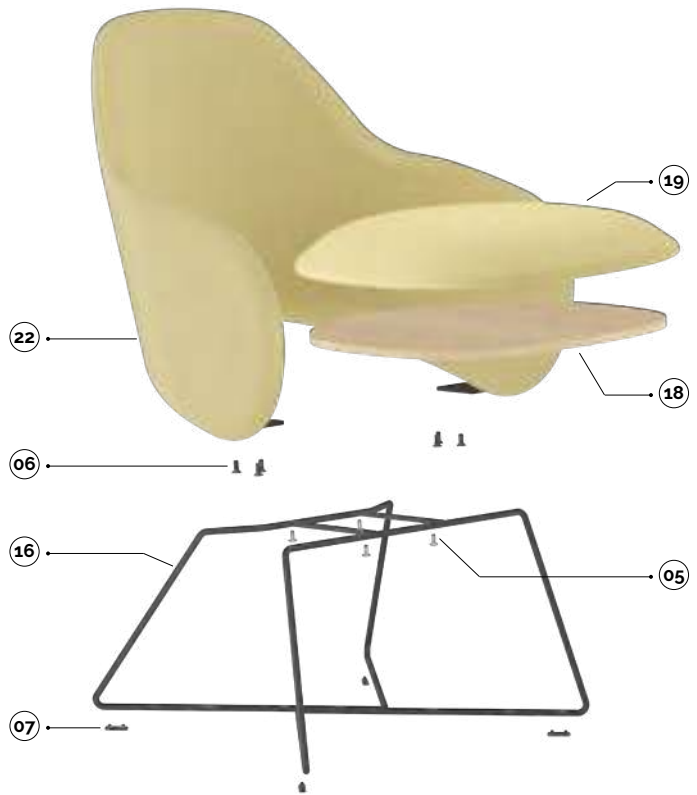

16 22 18 19 05 06 07

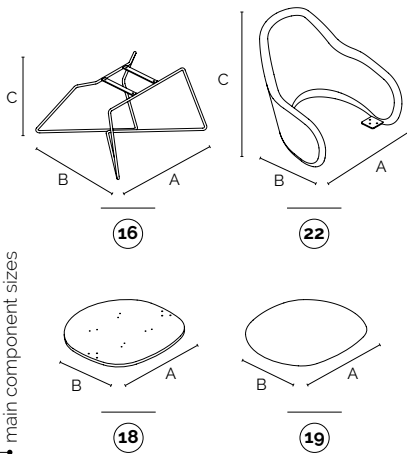

main component sizes

16

22

18

19

05

06

07

16 maui lounge - lounge plus - telaio a slitta - ø12 maui lounge - lounge plus - sled frame ø12

code	finishing	q.kit	q.pack	a	b	c	kg.x1	vol.x1
A113403-110	● nero/black	x1	/	650	610	360	4.30	/
A113405-110	● bianco/white	x1	/	650	610	360	4.30	/
113410-110	● cromato/chrome	x1	/	650	610	360	4.30	/

22 maui lounge plus - scocca schienale maui lounge plus - backrest shell

code	finishing	q.kit	q.pack	a	b	c	kg.x1	vol.x1
A133908-009	∅ da tappezzare/to be upholstered	x1	/	720	755	670	11.30	/

18 maui lounge - lounge plus - pannello in multistrato per sedile maui lounge - lounge plus - plywood seat panel

code	finishing	q.kit	q.pack	a	b	kg.x1	vol.x1
A123607-070	● pino/pinewood	x1	/	580	580	2.78	/

19 maui lounge - lounge plus - cuscino per sedile maui lounge - lounge plus - seat cushion

code	finishing	q.kit	q.pack	a	b	kg.x1	vol.x1
A134001-005	∅ da tappezzare/to be upholstered	x1	/	580	580	0.57	/

05 telai a slitta - vite dentellata TBEI M6x16 sled frames - TBEI M6x16 knurkled screw

code	finishing	q.kit	q.pack
117711-185	● bianco zincato/zinc-plated white	x4	/

06 maui dining - lounge - lounge plus - vite con frenafletti TSPEI m8x20 maui dining - lounge - lounge plus - TSPEI m8x20 screw with threadlocking

code	finishing	q.kit	q.pack
117703-257	● nero brunito0/burnished black	x6	/

07 telai a slitta - piedino in plastica a due pioli sled frames - two pins plastic glide

code	finishing	q.kit	q.pack
A134303-000	● nero/black	x4	/

maui

lounge plus swivel

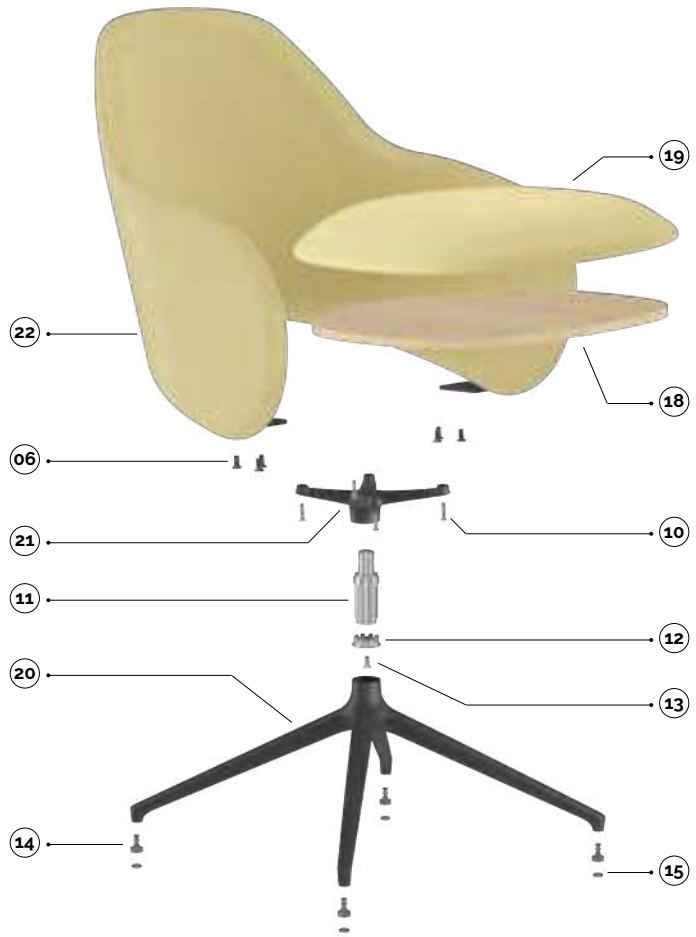

20 22 18 19 06 21 10 11 12 13 14 15

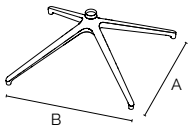

20

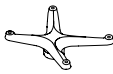

21



10



11



12



13



14



15

main component sizes

20 maui lounge - lounge plus - base kylie in alluminio a 4 razze - ø840
maui lounge - lounge plus - kylie 4-spokes aluminium base - ø840

code	finishing	q.kit	q.pack	a	b	kg.x1	vol.x1
A110203-101	● nero/black	x1	6	600	600	3.33	/
A110210-016	○ lucido/polished	x1	6	600	600	3.33	/

21 maui lounge - lounge plus - supporto in alluminio per base kylie - ø840
maui lounge - lounge plus - aluminium support for kylie base - ø840

code	finishing	q.kit	q.pack	kg.x1	vol.x1
A110203-104	● nero/black	x1	6	0.65	/
A110210-008	○ lucido/polished	x1	6	0.65	/

10 basi in alluminio a 4 razze kylie - vite TSP+ m6x30
kylie 4-spoke aluminium bases - TSP+ m6x30 screw

code	finishing	q.kit	q.pack
117711-192	● bianco zincato/zinc-plated white	x4	/

11 basi in alluminio a 4 razze kylie - adattatore in metallo
kylie 4-spoke aluminium bases - metal adapter

code	finishing	q.kit	q.pack	kg.x1
A110210-001	● zincato/zinc-plated	x1	6	/

12 basi in alluminio a 4 razze kylie - tappo sottobase
kylie 4-spoke aluminium bases - under-base cap

code	finishing	q.kit	q.pack	kg.x1
A110210-002	● grigio/grey	x1	6	/

13 basi in alluminio a 4 razze kylie - vite TSP+ m6x20
kylie 4-spoke aluminium bases - TSP+ m6x20 screw

code	finishing	q.kit	q.pack
117711-203	● bianco zincato/zinc-plated white	x1	6

14 basi in alluminio a 4 razze kylie - piedino in polipropilene
kylie 4-spoke aluminium bases - polypropylene glide

code	finishing	q.kit	q.pack	kg.x1
A110210-004	● grigio/grey	x4	24	/

15 basi in alluminio a 4 razze kylie - feltro per piedino in polipropilene
kylie 4-spoke aluminium bases - polypropylene glide felt

code	finishing	q.kit	q.pack
A110210-005	● nero/black	x4	24

for the components below, see previous page

22 18 19 06

maui

metal rod
coffee table

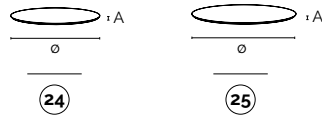
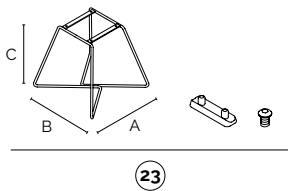
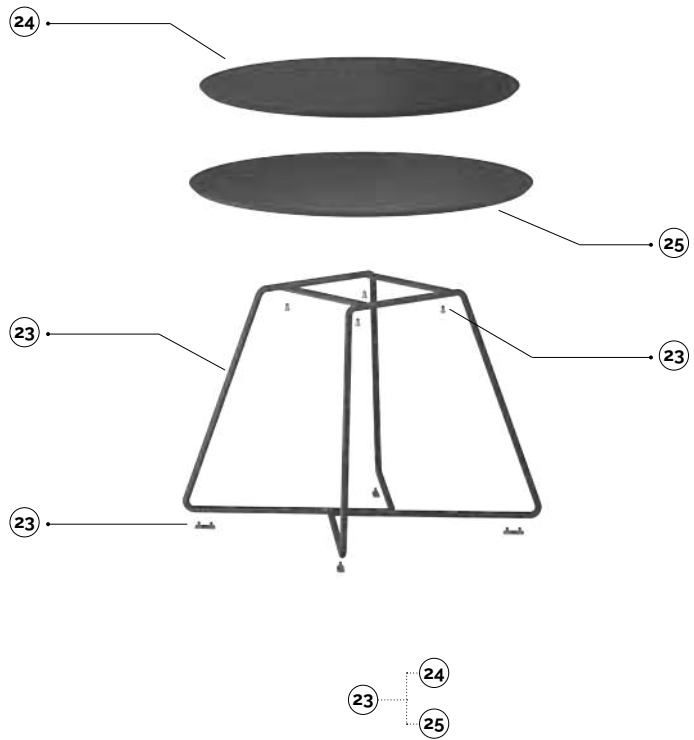

23 base in tondino - accessori: piedini, viti per piano
metal rod base - accessories: glides, tabletop fixing screws

code	finishing	q.kit	q.pack	a	b	c	kg.x1	vol.x1
110303-706	● nero/black	x1	30	447	455	408	3.55	mc. 0.1232
110304-705	● grigio/grey	x1	30	447	455	408	3.55	mc. 0.1232
110305-705	● avorio/ivory	x1	30	447	455	408	3.55	mc. 0.1232
110310-706	● cromato/chrome	x1	30	447	455	408	3.55	mc. 0.1232

24 top rotondo ø590
round top ø590

code	finishing	outdoor/indoor	q.kit	q.pack	ø	a	kg.x1	vol.x1
120303-021	● nero/black	outdoor/indoor	x1	1	590	10	4.00	mc. 0.0072
120305-021	● avorio/ivory	outdoor/indoor	x1	1	590	10	4.00	mc. 0.0072

25 top rotondo ø690
round top ø690

code	finishing	outdoor/indoor	q.kit	q.pack	ø	a	kg.x1	vol.x1
120303-022	● nero/black	outdoor/indoor	x1	1	690	10	5.70	mc. 0.0098
120305-022	● avorio/ivory	outdoor/indoor	x1	1	690	10	5.70	mc. 0.0098

main component sizes





meti



discover more about
Meti Collection

Meti è una collezione di sedute con e senza braccioli, con struttura in metallo e una scocca in poliuretano da rivestire in tessuto. Il suo schienale è avvolgente, comodo e accogliente, e le conferisce una linea elegante e pulita.

Le scocche sono fornite grezze, da tappezzare.

Meti is a collection of seats with and without armrests, with a metal frame and a polyurethane shell to be covered in fabric. Its backrest is enveloping, comfortable and welcoming, and gives it an elegant and clean line.

Shells are supplied unfinished, to be upholstered.

Plus

- Ideale per contract e ambienti residenziali, ricettivi e domestici
- *Ideal for contract and residential, hospitality and home environments.*
- 2 varianti: sedia e poltroncina.
- *2 variants: chair and armchair.*



designed by:
R&D Alba

meti

chair

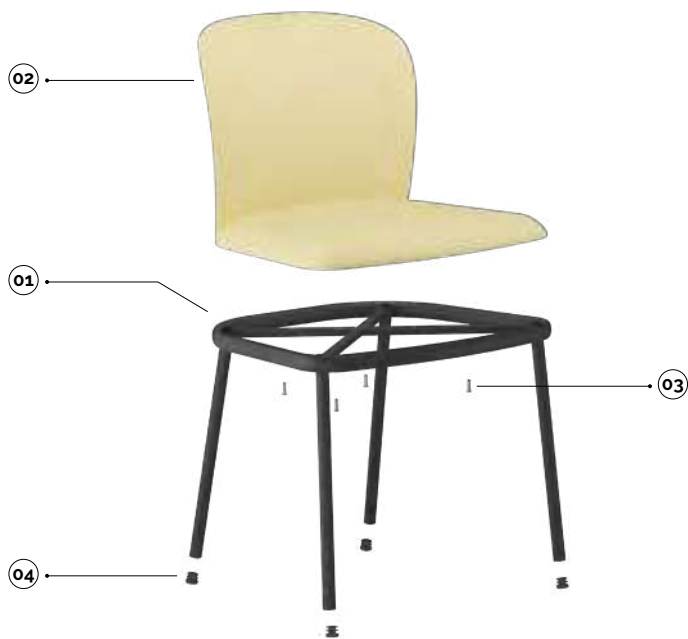

01 02 03 04

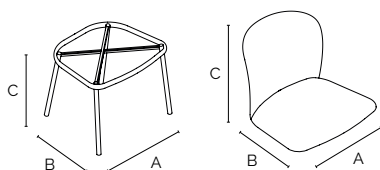

01

02



03



04

01 meti sedia - telaio a 4 gambe
meti chair - 4 legs frame

code	finishing	q.kit	q.pack	a	b	c	kg.x1	vol.x1
A110103-061	● nero/black	x1	1	550	490	430	3,80	/
A110105-061	● bianco/white	x1	1	550	490	430	3,80	/
A110110-061	● cromato/chrome	x1	1	550	490	430	3,80	/

02 meti sedia - scocca in poliuretano
meti chair - polyurethane shell

code	finishing	q.kit	q.pack	a	b	c	kg.x1	vol.x1
A133904-019	∅ da tappezzare/to be upholstered	x1	1	540	540	375	4,29	/

03 vite TBEI M6x25
TBEI M6x26 screw

code	finishing	q.kit
117711-194	● zincato/zinc-plated	x4

04 puntale alettato tondo Tl22 - Ø22
Tl22 inner cap for leg - Ø22

code	finishing	q.kit
134203-220	● nero/black	x4

meti

armchair

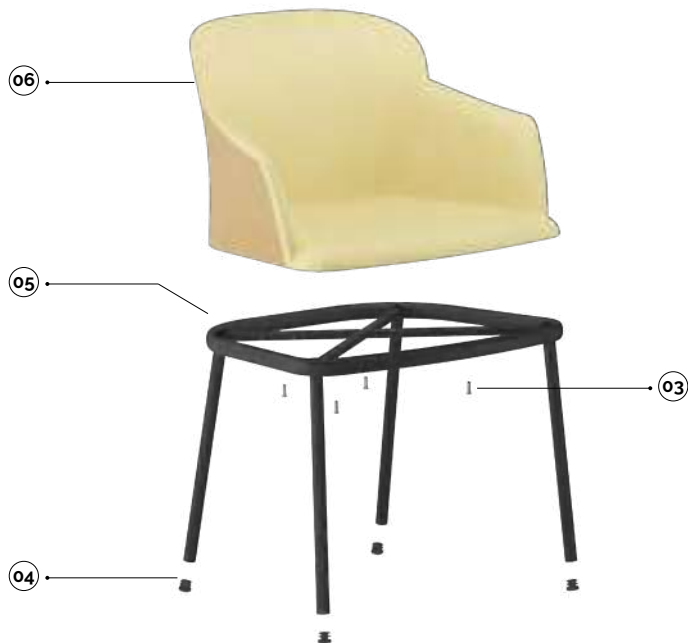

05 06 03 04

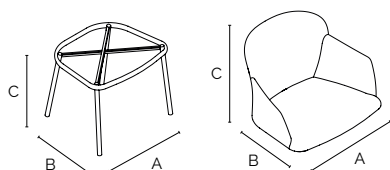

01

02



03



04

main component sizes

05 meti poltroncina - telaio a 4 gambe meti armchair - 4 legs frame

code	finishing	q.kit	q.pack	a	b	c	kg.x1	vol.x1
A111603-095	● nero/black	x1	1	590	490	430	3,95	/
A111605-095	● bianco/white	x1	1	590	490	430	3,95	/
A111610-095	● cromato/chrome	x1	1	590	490	430	3,95	/

06 meti poltroncina - scocca in poliuretano meti armchair - polyurethane shell

code	finishing	q.kit	q.pack	a	b	c	kg.x1	vol.x1
A133904-018	∅ da tappezzare/to be upholstered	x1	1	620	540	375	7,00	/

03 vite TBEI M6x25 TBEI M6x26 screw

code	finishing	q.kit
117711-194	● zincato/zinc-plated	x4

04 puntale alettato tondo Tl22 - Ø22 Tl22 inner cap for leg - Ø22

code	finishing	q.kit
134203-220	● nero/black	x4



tipper



discover more about
Tipper Collection

Ideale per gli ambienti conference e di co-working, la collezione Tipper garantisce vantaggi funzionali e distintivi: vanta infatti sia totale accatastabilità orizzontale, grazie alle gambe a chiusura inclinata, sia massima praticità, grazie alle maniglie blocca-sblocca poste su entrambi i lati, che consentono di ribaltare il piano anche con una sola mano.

Ideal for conference and co-working environments, the Tipper collection provides functional and distinctive advantages: it boasts both total horizontal stackability, thanks to the pivoting legs, and maximum practicality, thanks to the lock-and-unlock handles located on both sides, which allow the top to be tilted using even a single hand.

Plus

- Meccanismo di ribaltamento del piano brevettato.
- Certificazione ANSI/BIFMA X5.1.
- 3 diversi modelli di gamba: Duo, Classic e Pro.
- Compatibile con tutti i top standard.
- 6 lunghezze di traverso.
- *Patented tabletop tilting mechanism.*
- *ANSI/BIFMA X5.1 certification.*
- *3 different leg models: Duo, Classic and Pro.*
- *Compatible with all standard tabletops.*
- *6 beam lengths.*



designed by:
Esedra & R&D Alba



**certified
product**



**patented
product**

tipper

components

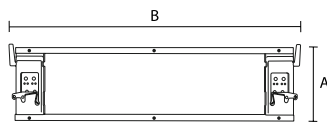

01 02 03 04 05 06

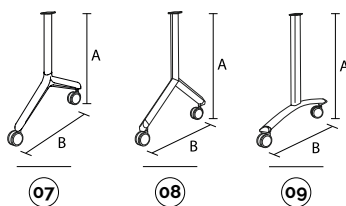

main component sizes

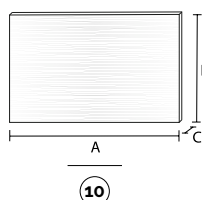

01 mech.1000 meccanismo ribaltabile per tavolo per piani L1000

mech.1000 mechanism for folding table for top L1000

code	finishing	q.kit	q.pack	a	b	kg.x1	vol.x1
110311-660	● zincato/zinc	x1	1	360	965	7,18	mc. 0.0543

02 mech.1200 meccanismo ribaltabile per tavolo per piani L1200

mech.1200 mechanism for folding table for top L1200

code	finishing	q.kit	q.pack	a	b	kg.x1	vol.x1
110311-007	● zincato/zinc	x1	1	360	1165	8,09	mc. 0.0543

03 mech.1400 meccanismo ribaltabile per tavolo per piani L1400

mech.1400 mechanism for folding table for top L1400

code	finishing	q.kit	q.pack	a	b	kg.x1	vol.x1
110311-661	● zincato/zinc	x1	1	360	1365	8,98	mc. 0.0627

04 mech.1500 meccanismo ribaltabile per tavolo per piani L1500

mech.1500 mechanism for folding table for top L1500

code	finishing	q.kit	q.pack	a	b	kg.x1	vol.x1
110311-008	● zincato/zinc	x1	1	360	1465	9,30	mc. 0.0627

05 mech.1600 meccanismo ribaltabile per tavolo per piani L1600

mech.1600 mechanism for folding table for top L1600

code	finishing	q.kit	q.pack	a	b	kg.x1	vol.x1
110311-662	● zincato/zinc	x1	1	360	1565	9,64	mc. 0.0627

06 mech.1800 meccanismo ribaltabile per tavolo per piani L1800

mech.1800 mechanism for folding table for top L1800

code	finishing	q.kit	q.pack	a	b	kg.x1	vol.x1
110311-009	● zincato/zinc	x1	1	360	1765	10,57	mc. 0.0752

07 duo-gamba per tavolo con accessori

duo-leg for table with accessories

code	finishing - metal frame	finishing - plastic foot	leg width	q.kit	q.pack	a	b	kg.x1	vol.x1
110303-270	● nero/black ral.g005	● nero/black ral.g005	600	x2	2	725	600	2,16	mc. 0.0126
110305-270	● bianco/white ral.g010	● bianco/white ral.g010	600	x2	2	725	600	2,16	mc. 0.0126
110304-270	● grigio/grey drylac	● grigio/grey drylac	600	x2	2	725	600	2,16	mc. 0.0126
110310-270	● cromato/chrome	● nero/black ral.g005	600	x2	2	725	600	2,16	mc. 0.0126
110303-273	● nero/black ral.g005	● nero/black ral.g005	750	x2	2	725	750	2,32	mc. 0.0146
110305-273	● bianco/white ral.g010	● bianco/white ral.g010	750	x2	2	725	750	2,32	mc. 0.0146
110304-273	● grigio/grey drylac	● grigio/grey drylac	750	x2	2	725	750	2,32	mc. 0.0146
110310-273	● cromato/chrome	● nero/black ral.g005	750	x2	2	725	750	2,32	mc. 0.0146

08 pro-gamba per tavolo con accessori

pro-leg for table with accessories

code	finishing	leg width	q.kit	q.pack	a	b	kg.x1	vol.x1
110303-197	● nero rag./black	600	x2	2	725	600	3,55	mc. 0.0328
110305-197	○ bianco/white	600	x2	2	725	600	3,55	mc. 0.0328
110304-197	● grigio/grey	600	x2	2	725	600	3,55	mc. 0.0328
110303-199	● nero rag./black	750	x2	2	725	750	3,75	mc. 0.0328
110305-199	○ bianco/white	750	x2	2	725	750	3,75	mc. 0.0328
110304-199	● grigio/grey	750	x2	2	725	750	3,75	mc. 0.0328

09 classic-gamba per tavolo con accessori

classic-leg for table with accessories

code	finishing	leg width	q.kit	q.pack	a	b	kg.x1	vol.x1
110303-196	● nero rag./black	600	x2	2	725	600	3,7	mc. 0.0328
110305-196	○ bianco/white	600	x2	2	725	600	3,7	mc. 0.0328
110304-196	● grigio/grey	600	x2	2	725	600	3,7	mc. 0.0328
110310-196	● cromato/chrome	600	x2	2	725	600	3,7	mc. 0.0328
110303-198	● nero rag./black	750	x2	2	725	750	3,9	mc. 0.0328
110305-198	○ bianco/white	750	x2	2	725	750	3,9	mc. 0.0328
110304-198	● grigio/grey	750	x2	2	725	750	3,9	mc. 0.0328
110310-198	● cromato/chrome	750	x2	2	725	750	3,9	mc. 0.0328

10 top piano nobilitato rovere

top wooden oak

code	finishing	q.kit	q.pack	a	b	c	kg.x1	vol.x1
120307-007	● nobilitato rovere / wooden oak	x1	1	1200	800	18	12,50	mc. 0.0173
120307-008	● nobilitato rovere / wooden oak	x1	1	1500	900	18	17,50	mc. 0.0243
120307-009	● nobilitato rovere / wooden oak	x1	1	1800	900	18	21,00	mc. 0.0291

tipper

components and optionals

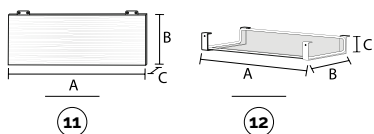

11 modesty panel con accessori
modesty panel with accessories

code	finishing	q.kit	q.pack	a	b	c	kg.x1	vol.x1
120307-010	● nobilitato rovere / wooden oak	x1	1	800	300	18	3,20	mc. 0.0043
120307-011	● nobilitato rovere / wooden oak	x1	1	1100	300	18	4,30	mc. 0.0059
120307-012	● nobilitato rovere / wooden oak	x1	1	1400	300	18	5,40	mc. 0.0075

12 portalibri
bookshelf

code	finishing	q.kit	q.pack	a	b	c	kg.x1	vol.x1
113403-403	● nero rag./black	x1	1	800	363	95	3,20	mc. 0.0244
113405-403	○ bianco/white	x1	1	800	363	95	3,20	mc. 0.0244
113404-403	● grigio/grey	x1	1	800	363	95	3,20	mc. 0.0244

13 gancio tipper—coppia ganci di unione per tavoli
tipper hook—pair of table linking device

code	finishing	q.kit	q.pack	kg.x1
134003-223	● nero rag./black	x2	20	0.005

14 coppia cerniere per modesty panel + viti
pair of hinges for modesty panel + screws

code	finishing	q.kit
120307-017	● zincato/zinc	x1

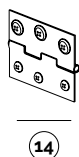
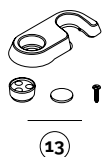

optionals

packaging

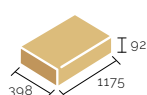

01

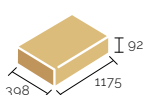

02

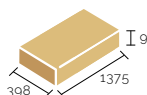

03

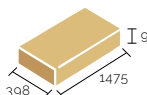

04

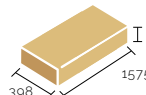

05

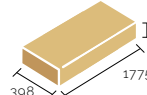

06

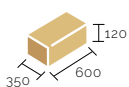

07
L 600

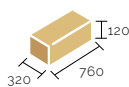

07
L 750

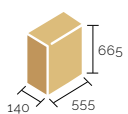

08
L 600

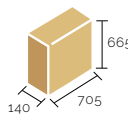

08
L 750

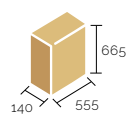

09
L 600

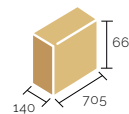

09
L 750

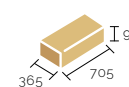

10

packaging specifications

article	version	q.pack	q.pallet	pallet size
Duo leg	600mm	2	144	800x1200x2300mm
Duo leg	750mm	2	132	800x1200x2300mm
Pro leg	600mm	2	84	1000x1200x2200mm
Pro leg	750mm	2	60	1000x1200x2200mm
Classic leg	600mm	2	84	1000x1200x2200mm
Classic leg	750mm	2	60	1000x1200x2200mm
Mechanism	1000mm	1	50	1000x1200x2050mm
Mechanism	1200mm	1	50	1000x1200x2050mm
Mechanism	1400mm	1	50	1000x1400x2050mm
Mechanism	1500mm	1	50	1000x1500x2050mm
Mechanism	1600mm	1	50	1000x1600x2050mm
Mechanism	1800mm	1	50	1000x1800x2050mm



clever



discover more about
Clever Collection

La struttura tavolo motorizzata e regolabile in altezza (da 60 cm a 125 cm) che pensa alla salute della vostra schiena. Il meccanismo, preciso e silenzioso grazie ai due motori elettrici sincronizzati, permette di memorizzare 4 posizioni personalizzate sul comodo ed elegante display.

La solida struttura in acciaio regolabile in larghezza (101 cm - 181 cm) garantisce la massima adattabilità ad ogni esigenza.

Disponibile in grigio e bianco.

The motorized and height adjustable (from 60 cm to 125 cm) table system, designed with your back care in mind. The mechanism, precise and silent thanks to the two synchronized electric motors, allows you to store 4 customized positions on a convenient and elegant display.

The solid, adjustable steel frame (width 101 cm - 181 cm) guarantees maximum adaptability to every need.

Available in grey and white.

Plus

- Trave telescopica compatibile con un gran numero di piani.
- Gambe telescopiche allungabili da 600 a 1250mm.
- Altezza regolabile tramite display a 4 memorie grazie a due motori elettrici sincronizzati.
- Optional: porta CPU.
- *Telescopic beam compatible with a large number of tabletops.*
- *Telescopic legs extendable from 600 to 1250mm.*
- *Height adjustable via 4-memory display by two synchronized electric motors.*
- *Optional: CPU holder.*

clever

components

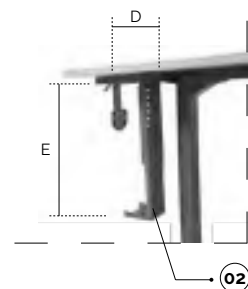
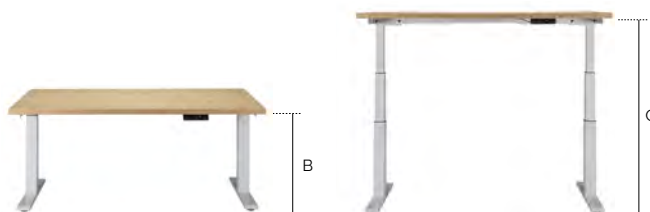
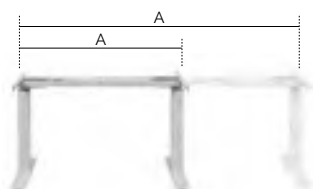
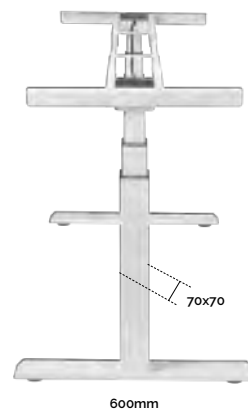
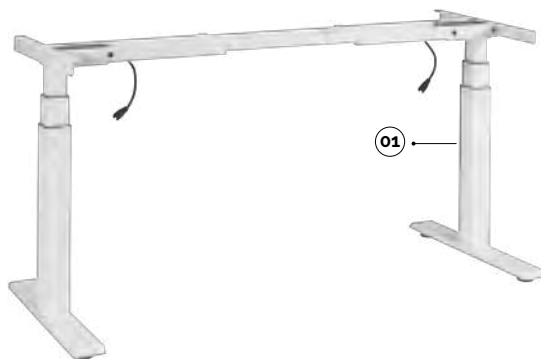

01 clever-struttura in metallo per tavolo elettrico regolabile in altezza
clever-electric height-adjustable desk metal frame

code	finishing		q.kit	q.pack	a	b	c	kg.x1	vol.x1
110304-102	● grigio/grey	ral 7045	x1	1	1010-1810	600	1250	29,00	mc. 0,063
110305-102	○ bianco/white	ral 9016	x1	1	1010-1810	600	1250	29,00	mc. 0,063

02 clever-porta cpu
clever-cpu holder

code	finishing		q.kit	q.pack	d	e	kg.x1	vol.x1
110304-103	● grigio/grey	ral 7045	x1	1	80-220	325-555	2,85	mc. 0,020
110305-103	○ bianco/white	ral 9016	x1	1	80-220	325-555	2,85	mc. 0,020

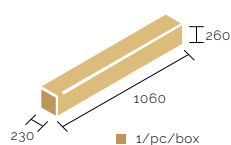

01

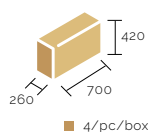

02





Frame width adjustable



Electric height-adjustable frame

Height range	60 cm → 125 cm
Load capacity	100 kg
Frame width adjustable	101 cm → 181 cm
Desktop sizes compatibility	110x60 cm → 240x120 cm
Travel speed	38 mm per seconds
Frame color	Grey RAL 7045 / White RAL 9016
Synchronized motors	2
Legs stage	3
Handset	Digital display & 4 preset buttons





contract tables

maui coffee table
riace collection



discover more about
Maui Coffee table



discover more about
Riace Collection

Contract Tables comprende il tavolino Maui e la collezione Riace, una gamma di tavoli e tavolini ideale per ogni spazio, in particolare il contesto Ho.Re.Ca. e home, grazie alla versatilità assicurata dalla sua ampia gamma di formati e dimensioni. Molteplici sono anche le finiture disponibili per i piani e per le strutture in metallo.

Contract Tables includes the Maui coffee table and the Riace collection, a range of tables and side tables ideal for any space, especially the Ho.Re.Ca. and home context, thanks to the versatility ensured by its wide range of formats and sizes. Multiple finishes are also available for the tops and metal frames.

Plus

- Ideale per contract e ambienti residenziali, ricettivi e domestici.
- Strutture disponibili in 3 diverse altezze e formati.
- Basi e colonne disponibili a sezione quadrata o tonda.
- *Ideal for contract and residential, hospitality and home environments.*
- *Structures available in 3 different heights and sizes.*
- *Bases and columns available in square or round sections.*



designed by:
R&D Alba

maui

metal rod
coffee table

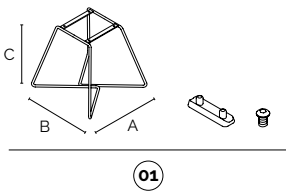
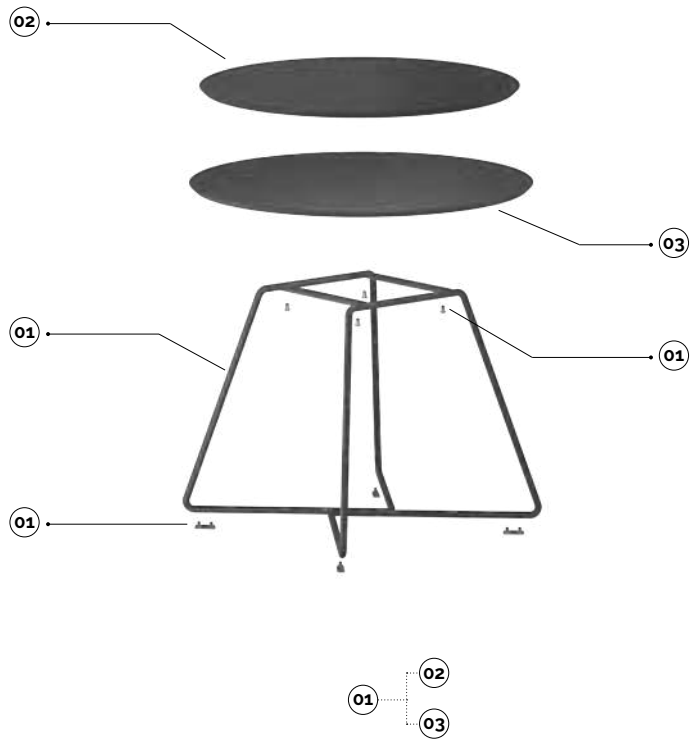

01

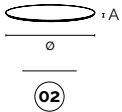

02

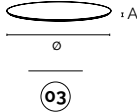

03

01 base in tondino - accessori: piedini, viti per piano
metal rod base - accessories: glides, tabletop fixing screws

code	finishing	q.kit	q.pack	a	b	c	kg.x1	vol.x1
110303-706	● nero/black	x1	30	447	455	408	3.55	mc. 0.1232
110304-705	● grigio/grey	x1	30	447	455	408	3.55	mc. 0.1232
110305-705	● avorio/ivory	x1	30	447	455	408	3.55	mc. 0.1232
110310-706	● cromato/chrome	x1	30	447	455	408	3.55	mc. 0.1232

02 top rotondo ø590
round top ø590

code	finishing	q.kit	q.pack	ø	a	kg.x1	vol.x1
120303-021	● nero/black outdoor/indoor	x1	1	590	10	4.00	mc. 0.0072
120305-021	● avorio/ivory outdoor/indoor	x1	1	590	10	4.00	mc. 0.0072

03 top rotondo ø690
round top ø690

code	finishing	q.kit	q.pack	ø	a	kg.x1	vol.x1
120303-022	● nero/black outdoor/indoor	x1	1	690	10	5.70	mc. 0.0098
120305-022	● avorio/ivory outdoor/indoor	x1	1	690	10	5.70	mc. 0.0098

main component sizes

riace

square low table

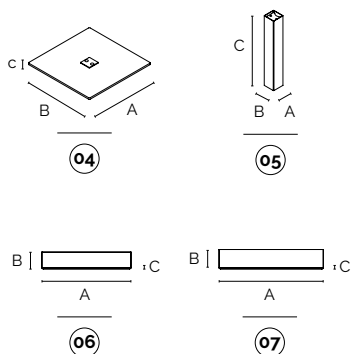
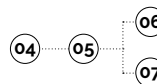
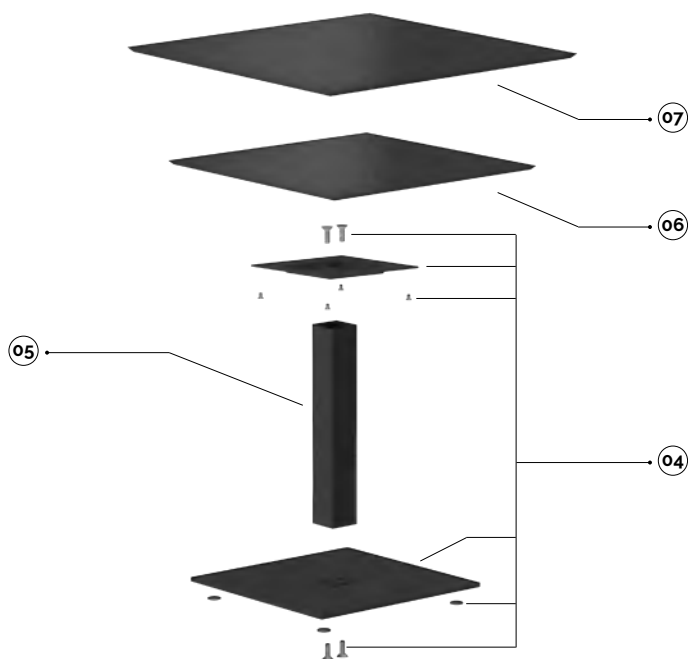

main component sizes

04 base quadrata - piastra per fissaggio piano - accessori: feltrini, viti per colonna, viti per piano
square base - tabletop fixing plate - accessories: adhesive felt pads, column fixing screws, tabletop fixing screws

code	finishing	q.kit	q.pack	a	b	c	kg.x1	vol.x1
110303-292	● nero/black	x1	1	390	390	8	10,65	mc. 0,0089
110304-282	● grigio/grey	x1	1	390	390	8	10,65	mc. 0,0089
110305-282	● avorio/ivory	x1	1	390	390	8	10,65	mc. 0,0089

05 colonna tavolino da caffè a sezione quadrata
coffee table square-section column

code	finishing	q.kit	q.pack	a	b	c	kg.x1	vol.x1
110303-293	● nero/black	x1	1	60	60	378	1,46	mc. 0,0043
110304-283	● grigio/grey	x1	1	60	60	378	1,46	mc. 0,0043
110305-283	● avorio/ivory	x1	1	60	60	378	1,46	mc. 0,0043

06 top quadrato 590x590
square top 590x590

code	finishing	q.kit	q.pack	a	b	c	kg.x1	vol.x1
120303-024	● nero/black	x1	1	590	590	10	5,70	mc. 0,0072
120305-024	● avorio/ivory	x1	1	590	590	10	5,70	mc. 0,0072

07 top quadrato 690x690
square top 690x690

code	finishing	q.kit	q.pack	a	b	c	kg.x1	vol.x1
120303-025	● nero/black	x1	1	690	690	10	7,80	mc. 0,0098
120305-025	● avorio/ivory	x1	1	690	690	10	7,80	mc. 0,0098

riace

round low table

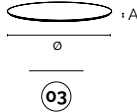
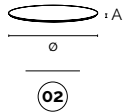
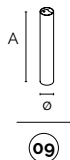
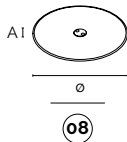
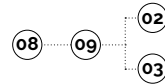
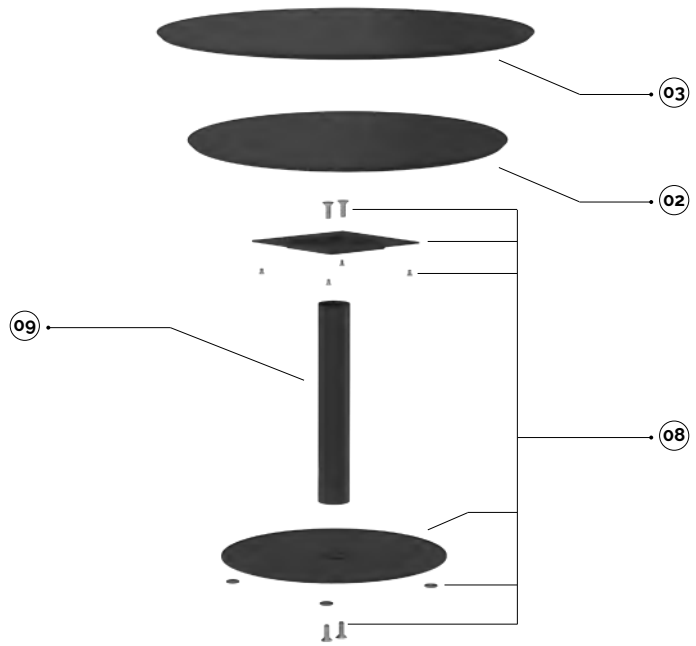

main component sizes

08 base tonda - piastra per fissaggio piano - accessori: feltrini, viti per colonna, viti per piano
round base - tabletop fixing plate - accessories: adhesive felt pads, column fixing screws, tabletop fixing screws

code	finishing	q.kit	q.pack	ø	a	kg.x1	vol.x1
110303-290	● nero/black	x1	1	420	6	8.42	mc. 0.0089
110304-280	● grigio/grey	x1	1	420	6	8.42	mc. 0.0089
110305-280	● avorio/ivory	x1	1	420	6	8.42	mc. 0.0089

09 colonna tavolino da caffè a sezione tonda
coffee table round-section column

code	finishing	q.kit	q.pack	ø	a	kg.x1	vol.x1
110303-291	● nero/black	x1	1	60	380	1.20	mc. 0.0043
110304-281	● grigio/grey	x1	1	60	380	1.20	mc. 0.0043
110305-281	● avorio/ivory	x1	1	60	380	1.20	mc. 0.0043

02 top rotondo ø590
round top ø590

code	finishing	q.kit	q.pack	ø	a	kg.x1	vol.x1
120303-021	● nero/black	x1	1	590	10	4.00	mc. 0.0072
120305-021	● avorio/ivory	x1	1	590	10	4.00	mc. 0.0072

03 top rotondo ø690
round top ø690

code	finishing	q.kit	q.pack	ø	a	kg.x1	vol.x1
120303-022	● nero/black	x1	1	690	10	5.70	mc. 0.0098
120305-022	● avorio/ivory	x1	1	690	10	5.70	mc. 0.0098

riace

square medium table

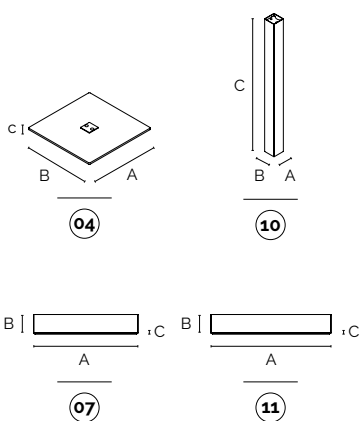
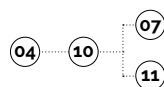
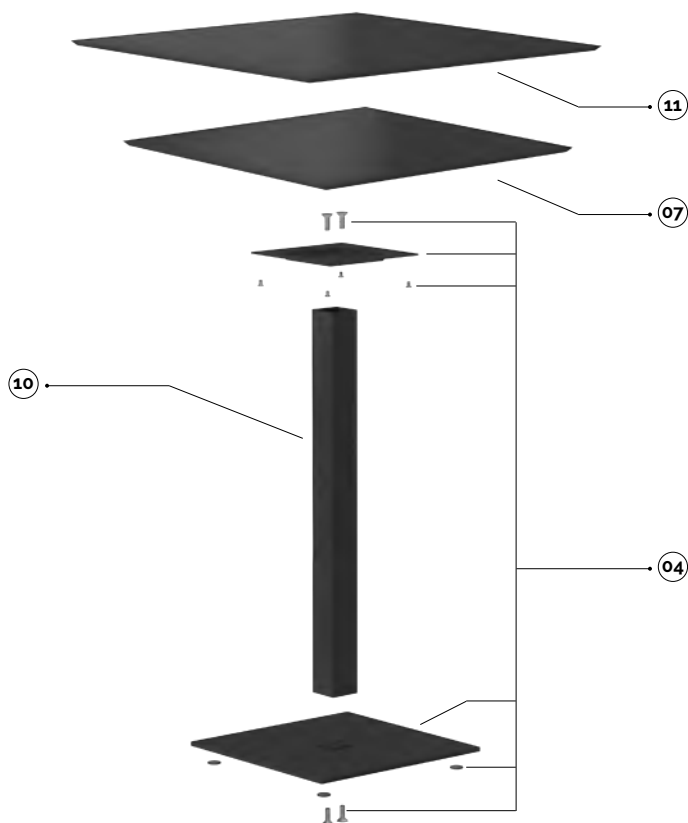

04 base quadrata - piastra per fissaggio piano - accessori: feltrini, viti per colonna, viti per piano
square base - tabletop fixing plate - accessories: adhesive felt pads, column fixing screws, tabletop fixing screws

code	finishing	q.kit	q.pack	a	b	c	kg.x1	vol.x1
110303-292	● nero/black	x1	1	390	390	8	10,65	mc. 0,0089
110304-282	● grigio/grey	x1	1	390	390	8	10,65	mc. 0,0089
110305-282	● avorio/ivory	x1	1	390	390	8	10,65	mc. 0,0089

10 colonna media a sezione quadrata
medium square-section column

code	finishing	q.kit	q.pack	a	b	c	kg.x1	vol.x1
110303-295	● nero/black	x1	1	60	60	720	2,72	mc. 0,0043
110304-285	● grigio/grey	x1	1	60	60	720	2,72	mc. 0,0043
110305-285	● avorio/ivory	x1	1	60	60	720	2,72	mc. 0,0043

07 top quadrato 690x690
square top 690x690

code	finishing	q.kit	q.pack	a	b	c	kg.x1	vol.x1
120303-025	● nero/black	x1	1	690	690	10	7,80	mc. 0,0098
120305-025	● avorio/ivory	x1	1	690	690	10	7,80	mc. 0,0098

11 top quadrato 790x790
square top 790x790

code	finishing	q.kit	q.pack	a	b	c	kg.x1	vol.x1
120303-026	● nero/black	x1	1	790	790	10	10,70	mc. 0,0128
120305-026	● avorio/ivory	x1	1	790	790	10	10,70	mc. 0,0128

main component sizes

riace

round medium table

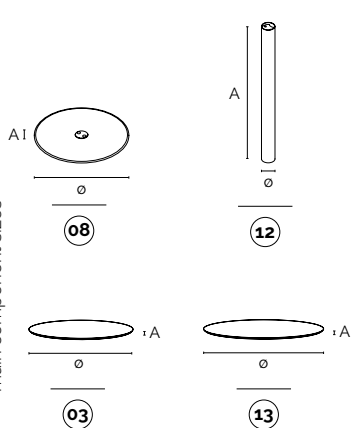
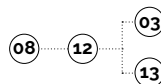
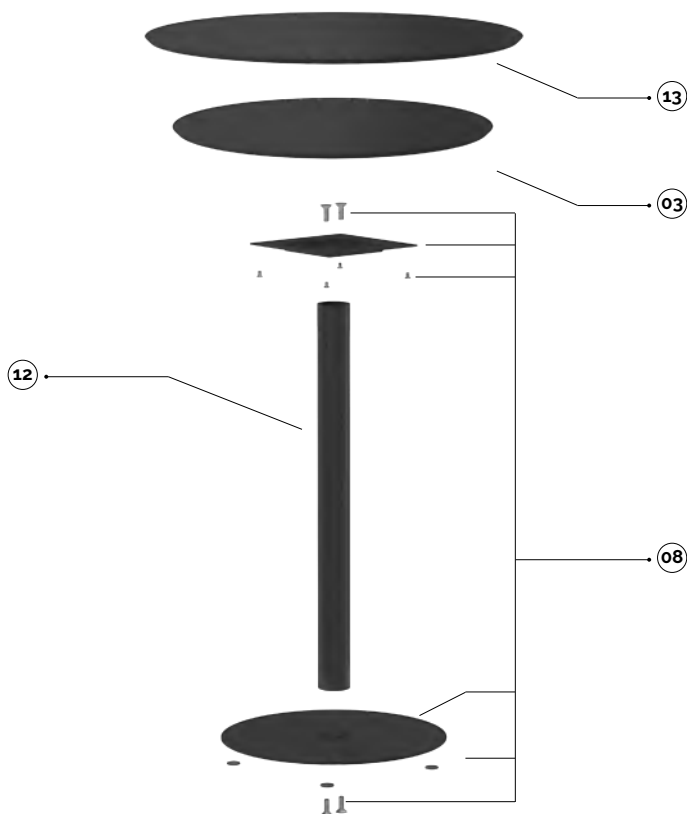

08 base tonda - piastra per fissaggio piano - accessori: feltrini, viti per colonna, viti per piano
round base - tabletop fixing plate - accessories: adhesive felt pads, column fixing screws, tabletop fixing screws

code	finishing	q.kit	q.pack	ø	a	kg.x1	vol.x1
110303-290	● nero/black	x1	1	420	6	8.42	mc. 0.0089
110304-280	● grigio/grey	x1	1	420	6	8.42	mc. 0.0089
110305-280	● avorio/ivory	x1	1	420	6	8.42	mc. 0.0089

12 colonna media a sezione tonda
medium round-section column

code	finishing	q.kit	q.pack	ø	a	kg.x1	vol.x1
110303-294	● nero/black	x1	1	60	722	1.92	mc. 0.0043
110304-284	● grigio/grey	x1	1	60	722	1.92	mc. 0.0043
110305-284	● avorio/ivory	x1	1	60	722	1.92	mc. 0.0043

03 top rotondo ø690
round top ø690

code	finishing	q.kit	q.pack	ø	a	kg.x1	vol.x1
120303-022	● nero/black	x1	1	690	10	5.70	mc. 0.0098
120305-022	● avorio/ivory	x1	1	690	10	5.70	mc. 0.0098

13 top rotondo ø790
round top ø790

code	finishing	q.kit	q.pack	ø	a	kg.x1	vol.x1
120303-023	● nero/black	x1	1	790	10	8.40	mc. 0.0128
120305-023	● avorio/ivory	x1	1	790	10	8.40	mc. 0.0128

riace

rectangular medium table

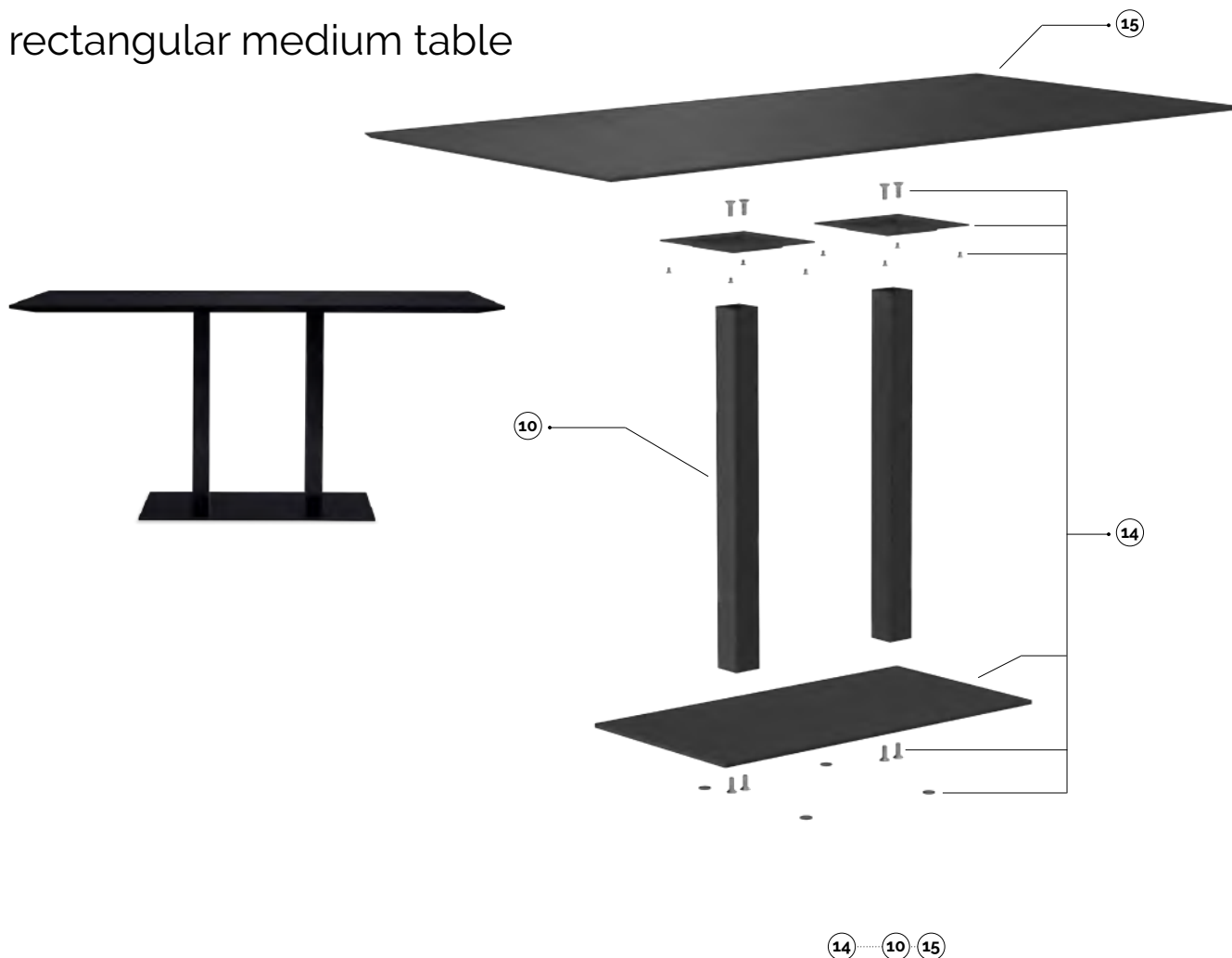

main component sizes

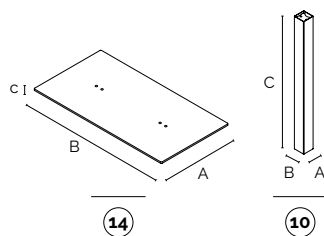

14

10

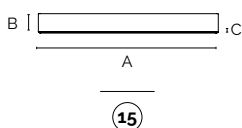

15

14 base rettangolare - piastra per fissaggio piano - accessori: feltrini, viti per colonna, viti per piano
 rectangular base - tabletop fixing plate - accessories: adhesive felt pads, column fixing screws, tabletop fixing screws

code	finishing	q.kit	q.pack	a	b	c	kg.x1	vol.x1
110303-288	● nero/black	x1	1	800	420	8	23,5	mc. 0.018
110304-288	● grigio/grey	x1	1	800	420	8	23,5	mc. 0.018
110305-288	● avorio/ivory	x1	1	800	420	8	23,5	mc. 0.018

10 colonna media a sezione quadrata
 medium square-section column

code	finishing	q.kit	q.pack	a	b	c	kg.x1	vol.x1
110303-295	● nero/black	x2	1	60	60	720	2,72	mc. 0.0043
110304-285	● grigio/grey	x2	1	60	60	720	2,72	mc. 0.0043
110305-285	● avorio/ivory	x2	1	60	60	720	2,72	mc. 0.0043

15 top rettangolare 1590x790
 rectangular top 1590x790

code	finishing		q.kit	q.pack	a	b	c	kg.x1	vol.x1
120303-027	● nero/black	outdoor/indoor	x1	1	1590	790	10	13,5	mc. 0.0168
120305-027	● avorio/ivory	outdoor/indoor	x1	1	1590	790	10	13,5	mc. 0.0168

riace

square high table

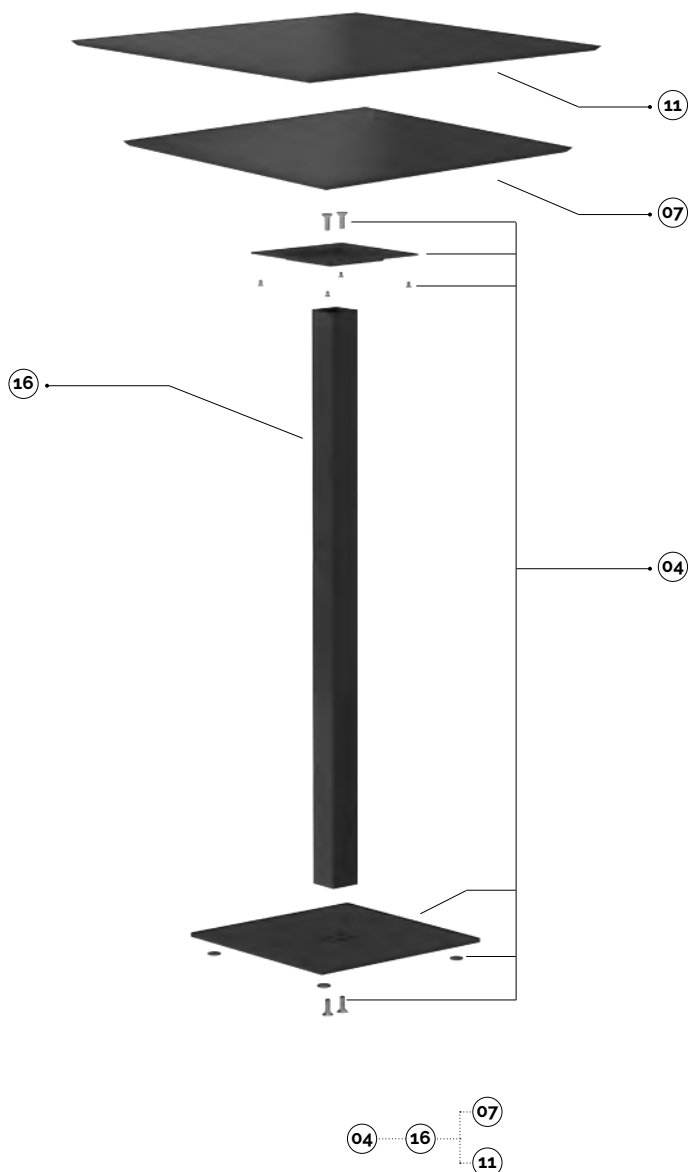

main component sizes

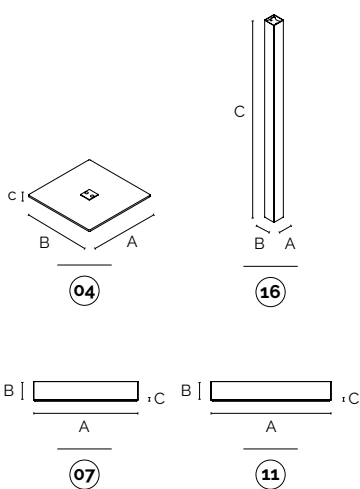

04 base quadrata - piastra per fissaggio piano - accessori: feltrini, viti per colonna, viti per piano
square base - tabletop fixing plate - accessories: adhesive felt pads, column fixing screws, tabletop fixing screws

code	finishing	q.kit	q.pack	a	b	c	kg.x1	vol.x1
110303-292	● nero/black	x1	1	390	390	8	10.65	mc. 0.008g
110304-282	● grigio/grey	x1	1	390	390	8	10.65	mc. 0.008g
110305-282	● avorio/ivory	x1	1	390	390	8	10.65	mc. 0.008g

16 colonna alta a sezione quadrata
high square-section column

code	finishing	q.kit	q.pack	a	b	c	kg.x1	vol.x1
110303-297	● nero/black	x1	1	60	60	1070	3.30	mc. 0.006
110304-287	● grigio/grey	x1	1	60	60	1070	3.30	mc. 0.006
110305-287	● avorio/ivory	x1	1	60	60	1070	3.30	mc. 0.006

07 top quadrato 690x690
square top 690x690

code	finishing	outdoor/indoor	q.kit	q.pack	a	b	c	kg.x1	vol.x1
120303-025	● nero/black	outdoor/indoor	x1	1	690	690	10	7.80	mc. 0.0098
120305-025	● avorio/ivory	outdoor/indoor	x1	1	690	690	10	7.80	mc. 0.0098

11 top quadrato 790x790
square top 790x790

code	finishing	outdoor/indoor	q.kit	q.pack	a	b	c	kg.x1	vol.x1
120303-026	● nero/black	outdoor/indoor	x1	1	790	790	10	10.70	mc. 0.0128
120305-026	● avorio/ivory	outdoor/indoor	x1	1	790	790	10	10.70	mc. 0.0128

riace

round high table

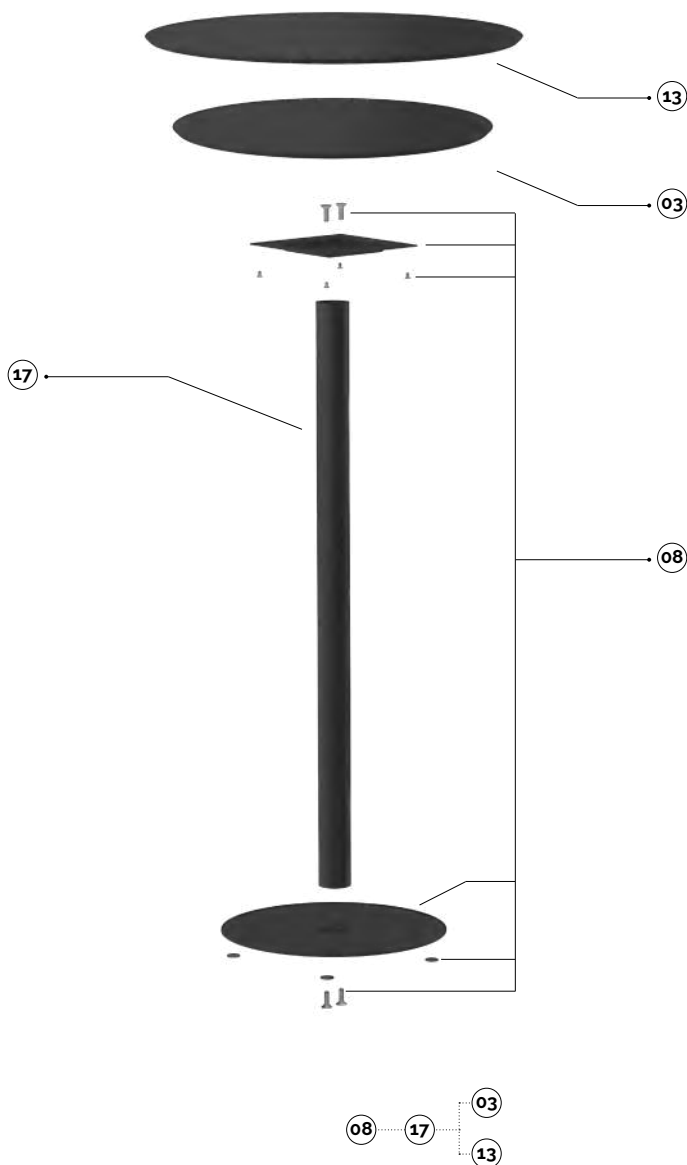

main component sizes

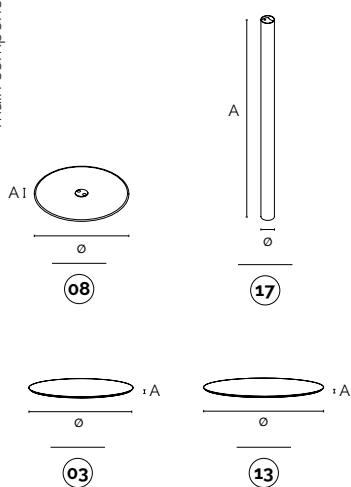

08 base tonda - piastra per fissaggio piano - accessori: feltrini, viti per colonna, viti per piano
round base - tabletop fixing plate - accessories: adhesive felt pads, column fixing screws, tabletop fixing screws

code	finishing	q.kit	q.pack	ø	a	kg.x1	vol.x1
110303-290	● nero/black	x1	1	420	6	8.42	mc. 0.0089
110304-280	● grigio/grey	x1	1	420	6	8.42	mc. 0.0089
110305-280	● avorio/ivory	x1	1	420	6	8.42	mc. 0.0089

17 colonna alta a sezione tonda
high round-section column

code	finishing	q.kit	q.pack	ø	a	kg.x1	vol.x1
110303-296	● nero/black	x1	1	60	1072	2.72	mc. 0.006
110304-286	● grigio/grey	x1	1	60	1072	2.72	mc. 0.006
110305-286	● avorio/ivory	x1	1	60	1072	2.72	mc. 0.006

03 top rotondo ø690
round top ø690

code	finishing	q.kit	q.pack	ø	a	kg.x1	vol.x1
120303-022	● nero/black	x1	1	690	10	5.70	mc. 0.0098
120305-022	● avorio/ivory	x1	1	690	10	5.70	mc. 0.0098

13 top rotondo ø790
round top ø6790

code	finishing	q.kit	q.pack	ø	a	kg.x1	vol.x1
120303-023	● nero/black	x1	1	790	10	8.40	mc. 0.0128
120305-023	● avorio/ivory	x1	1	790	10	8.40	mc. 0.0128

riace

rectangular high table

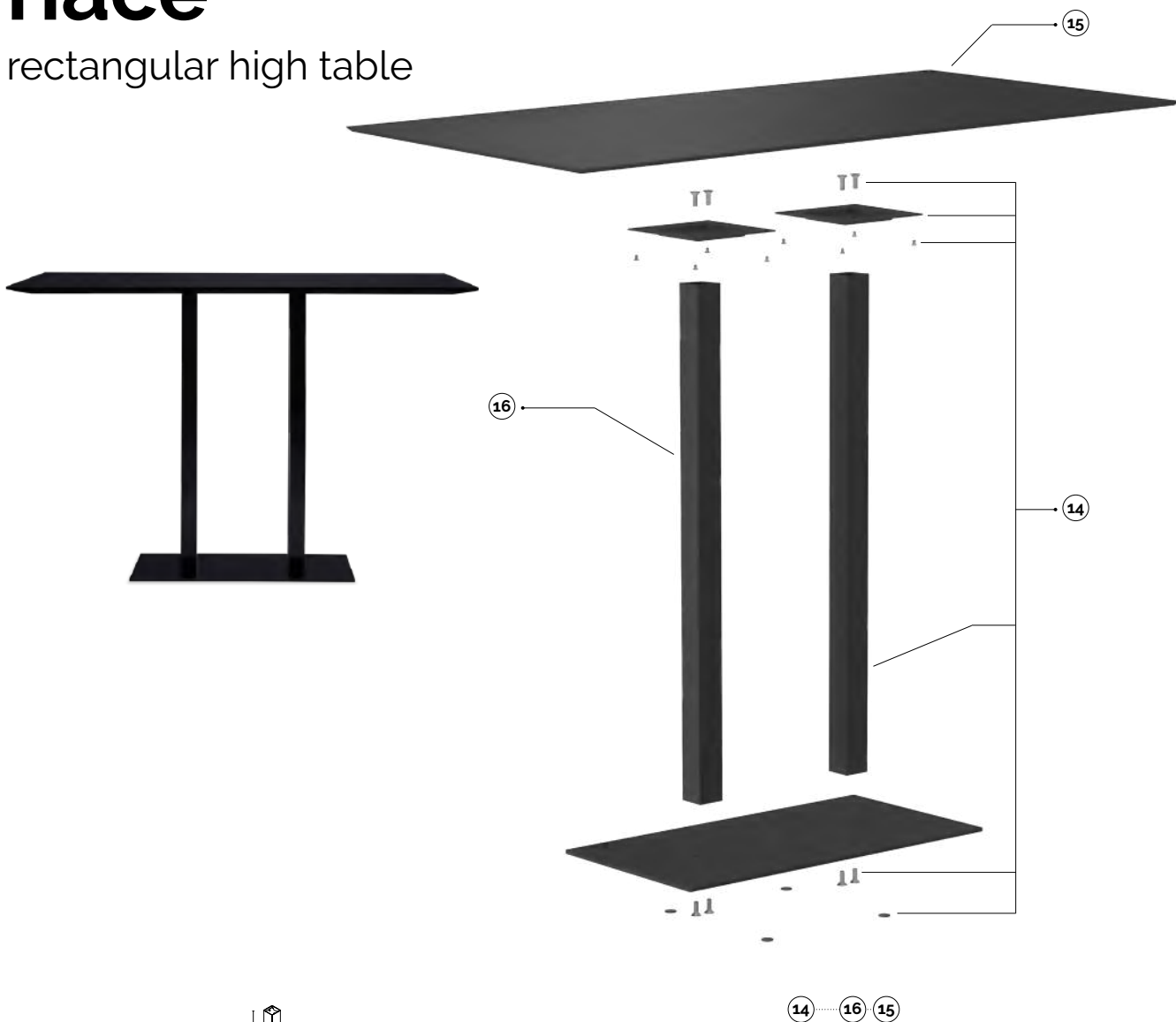

main component sizes

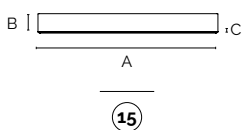
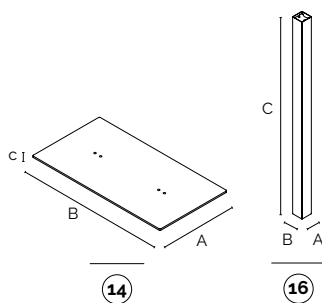

14 base rettangolare - piastra per fissaggio piano - accessori: feltrini, viti per colonna, viti per piano
 rectangular base - tabletop fixing plate - accessories: adhesive felt pads, column fixing screws, tabletop fixing screws

code	finishing	q.kit	q.pack	a	b	c	kg.x1	vol.x1
110303-288	● nero/black	x1	1	800	420	8	23,5	mc. 0.018
110304-288	● grigio/grey	x1	1	800	420	8	23,5	mc. 0.018
110305-288	● avorio/ivory	x1	1	800	420	8	23,5	mc. 0.018

16 colonna alta a sezione quadrata
 high square-section column

code	finishing	q.kit	q.pack	a	b	c	kg.x1	vol.x1
110303-297	● nero/black	x2	1	60	60	1070	3,30	mc. 0.006
110304-287	● grigio/grey	x2	1	60	60	1070	3,30	mc. 0.006
110305-287	● avorio/ivory	x2	1	60	60	1070	3,30	mc. 0.006

15 top rettangolare 1590x790
 rectangular top 1590x790

code	finishing	q.kit	q.pack	a	b	c	kg.x1	vol.x1
120303-027	● nero/black outdoor/indoor	x1	1	1590	790	10	13,5	mc. 0.0168
120305-027	● avorio/ivory outdoor/indoor	x1	1	1590	790	10	13,5	mc. 0.0168





tapas



discover more about
Tapas Collection

La nuova linea per l'ambiente Ho.re.ca.
Una collezione innovativa e completa,
che si sviluppa in due famiglie.

La prima, per uso indoor & outdoor, è
completamente smontabile, pratica
nell'assemblaggio e di grande solidità,
con un design funzionale e versatile
grazie alle numerose varianti di finitura.
La seconda è pensata appositamente
per l'outdoor, con telai dedicati e
finiture dei materiali ideali per questo
tipo di utilizzo.

Tapas è ideale per l'ambiente Contract.

*The new product line for the Ho.re.ca
environment. An innovative and complete
collection that is divided into two families.*

*The first, for indoor & outdoor use, can
be completely disassembled, is easy
to assemble and is very solid, with a
functional and versatile design due to its
numerous finish variations.
The second is designed specifically for
outdoor use, with dedicated frames and
material finishes that are ideal for this
type of use.*

*Tapas is ideal for the Contract
environment.*

Plus

- Numerose varianti di finitura.
- Versatilità nell'utilizzo grazie alle specifiche finiture per l'outdoor.
- I kit della famiglia indoor & outdoor prevedono un imballo smontato per ridurre i costi di movimentazione.
- Semplice da assemblare.
- Sgabelli certificati
EN 16139:2013+AC2013 Livello 2.
- Tavoli certificati
EN 15372:2016 Livello 2.
- Numerous finish variations.
- Versatility in its use due to the specific finished for outdoor use.
- The indoor & outdoor family kits come in a disassembled package to reduce handling costs.
- Easy to assemble.
- Stools certified
EN 16139:2013+AC2013 Level 2.
- Tables certified to
EN 15372:2016 Level 2.



designed by:
Edi & Paolo Ciani Design



**outdoor
ready**



**UV plastic
protection**

tapas

stool

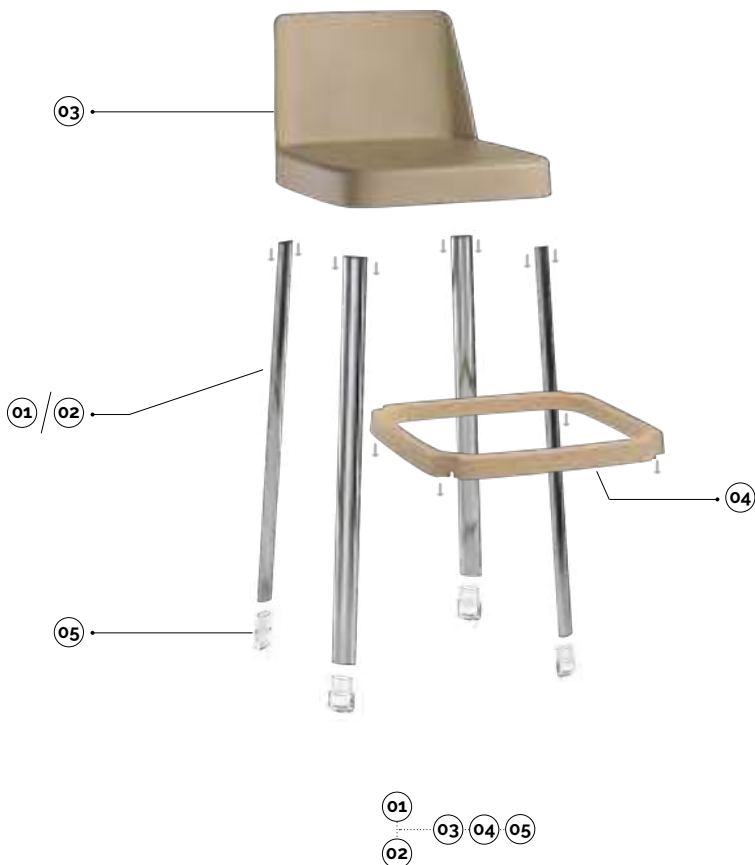

plastic colours

- avorio/ivory ral1013
- nocciola/hazelnut 2312u
- grigio/grey ig2621
- nero/black ral9005

Corten ● *Specifica caratteristica del Corten è la variabilità nella tonalità della finitura.
* A specific characteristic of Corten is the variability in the tone of the finish.

main component sizes

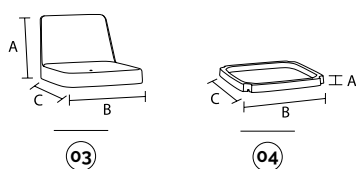
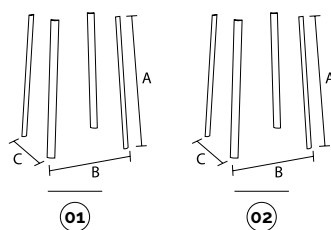

01 tapas-sgabello h650 kit n'4 gambe con viti

tapas-kit stool h650 n'4 legs with screws

code	finishing	q.kit	q.pack	a	b	c	kg.x1	vol.x1
110603-637	● nero/black	x1	5	650	410	410	3.54	mc. 0.0035
110604-637	● grigio/grey ig2621	x1	5	650	410	410	3.54	mc. 0.0035
110605-637	● avorio/ivory ral 1013	x1	5	650	410	410	3.54	mc. 0.0035
110607-637	● corten*	x1	5	650	410	410	3.54	mc. 0.0035
110610-637	● cromato/chrome	x1	5	650	410	410	3.54	mc. 0.0035
110603-638	● nero/black	x1	5	650	410	410	3.54	mc. 0.0035
110604-638	● grigio/grey ig2621	x1	5	650	410	410	3.54	mc. 0.0035
110605-638	● avorio/ivory ral 1013	x1	5	650	410	410	3.54	mc. 0.0035
110607-638	● corten*	x1	5	650	410	410	3.54	mc. 0.0035

02 tapas-sgabello h750 kit n'4 gambe con viti

tapas-kit stool h750 n'4 legs with screws

code	finishing	q.kit	q.pack	a	b	c	kg.x1	vol.x1
110603-635	● nero/black	x1	5	750	422	422	3.54	mc. 0.0035
110604-635	● grigio/grey ig2621	x1	5	750	422	422	3.54	mc. 0.0035
110605-635	● avorio/ivory ral 1013	x1	5	750	422	422	3.54	mc. 0.0035
110607-635	● corten*	x1	5	750	422	422	3.54	mc. 0.0035
110610-635	● cromato/chrome	x1	5	750	422	422	3.54	mc. 0.0035
110603-636	● nero/black	x1	5	750	422	422	3.54	mc. 0.0035
110604-636	● grigio/grey ig2621	x1	5	750	422	422	3.54	mc. 0.0035
110605-636	● avorio/ivory ral 1013	x1	5	750	422	422	3.54	mc. 0.0035
110607-636	● corten*	x1	5	750	422	422	3.54	mc. 0.0035

03 tapas-scocca seduta sgabello

tapas-stool plastic shell

code	finishing	q.kit	q.pack	a	b	c	kg.x1	vol.x1
130603-003	● nero/black	x1	5	276	382	458	2.06	mc. 0.02045
130604-003	● grigio/grey 650	x1	5	276	382	458	2.06	mc. 0.02045
130605-003	● avorio/ivory ral 1013	x1	5	276	382	458	2.06	mc. 0.02045
130607-003	● nocciola/hazelnut 2312u	x1	5	276	382	458	2.06	mc. 0.02045

04 tapas-poggiapiedi sgabello

tapas-stool footrest

code	finishing	q.kit	a	b	c	kg.x1		
130603-000	● nero/black	x1	5	34	417	417	0.874	mc. 0.01092
130604-000	● grigio/grey 650	x1	5	34	417	417	0.874	mc. 0.01092
130605-002	● avorio/ivory ral 1013	x1	5	34	417	417	0.874	mc. 0.01092
130607-000	● nocciola/hazelnut 2312u	x1	5	34	417	417	0.874	mc. 0.01092

05 tapas-piedino ellittico 40x20 h30

tapas-elliptical glide 40x20 h30

code	finishing	q.kit	kg.x1	
134303-045	● nero/black	x4	0.0174	mc. 0.00003
134306-005	○ trasparente/transparent	x4	0.0174	mc. 0.00003

tapas

high table

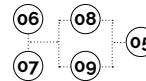
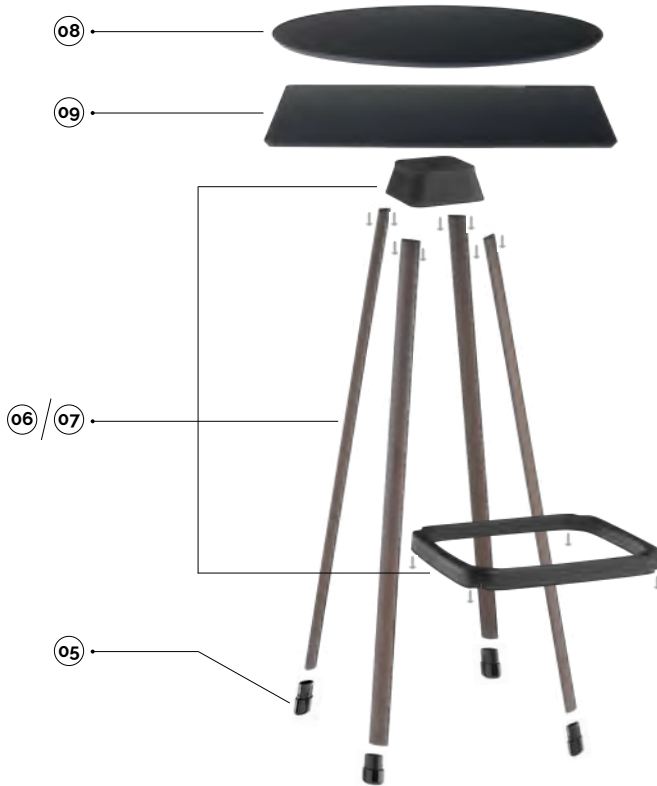

Si consigliano le seguenti misure di top:
The following top measures are recommended:

- high table: 590 / 690 mm

plastic colours

- avorio/ivory ral1013
- nero/black ral9005

Corten
*Specifica caratteristica del Corten è la variabilità nella tonalità della finitura.
* A specific characteristic of Corten is the variability in the tone of the finish.

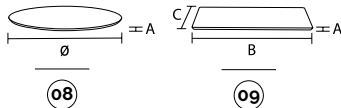
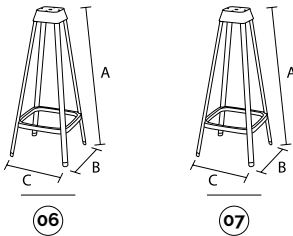

main component sizes

06 tapas-kit gambe tavolo alto con viti + supporto + poggipiedi avorio r1013

tapas-kit high table legs with screws + table frame + footrest ivory r1013

code	finishing	q.kit	q.pack	a	b	c	kg.x1	vol.x1
110303-244	● nero/black	x1	2	1085	453	453	8,0	mc. 0.02365
110304-244	● grigio/grey ig2621	x1	2	1085	453	453	8,0	mc. 0.02365
110305-244	● avorio/ivory ral 1013	x1	2	1085	453	453	8,0	mc. 0.02365
110307-244	● corten*	x1	2	1085	453	453	8,0	mc. 0.02365
110310-244	● cromato/chrome	x1	2	1085	453	453	8,0	mc. 0.02365
110303-246	● nero/black	*per esterno/outdoor	x1	2	1085	453	8,0	mc. 0.02365
110304-246	● grigio/grey ig2621	*per esterno/outdoor	x1	2	1085	453	8,0	mc. 0.02365
110305-246	● avorio/ivory ral 1013	*per esterno/outdoor	x1	2	1085	453	8,0	mc. 0.02365
110307-246	● corten*	*per esterno/outdoor	x1	2	1085	453	8,0	mc. 0.02365

07 tapas-kit gambe tavolo alto con viti + supporto + poggipiedi nero

tapas-kit high table legs with screws + table frame + footrest black

code	finishing	q.kit	q.pack	a	b	c	kg.x1	vol.x1
110303-245	● nero/black	x1	2	1085	453	453	8,0	mc. 0.02365
110304-245	● grigio/grey ig2621	x1	2	1085	453	453	8,0	mc. 0.02365
110305-245	● avorio/ivory ral 1013	x1	2	1085	453	453	8,0	mc. 0.02365
110307-245	● corten*	x1	2	1085	453	453	8,0	mc. 0.02365
110310-245	● cromato/chrome	x1	2	1085	453	453	8,0	mc. 0.02365
110303-247	● nero/black	*per esterno/outdoor	x1	2	1085	453	8,0	mc. 0.02365
110304-247	● grigio/grey ig2621	*per esterno/outdoor	x1	2	1085	453	8,0	mc. 0.02365
110305-247	● avorio/ivory ral 1013	*per esterno/outdoor	x1	2	1085	453	8,0	mc. 0.02365
110307-247	● corten*	*per esterno/outdoor	x1	2	1085	453	8,0	mc. 0.02365

08 tapas-top rotondo in hpl

tapas-round hpl top

code	finishing	q.kit	q.pack	a	ø	kg.x1	vol.x1
120303-021	● nero/black	x1	5	10	590	4,8	mc. 0.0072
120303-022	● nero/black	x1	5	10	690	6,6	mc. 0.0098
120303-023	● nero/black	x1	5	10	790	8,4	mc. 0.0128
120305-021	● avorio/ivory ral 1013	x1	5	10	590	4,8	mc. 0.0072
120305-022	● avorio/ivory ral 1013	x1	5	10	690	6,6	mc. 0.0098
120305-023	● avorio/ivory ral 1013	x1	5	10	790	8,4	mc. 0.0128

09 tapas-top quadrato in hpl

tapas-square hpl top

code	finishing	q.kit	q.pack	a	b	c	kg.x1	vol.x1
120303-024	● nero/black	x1	5	10	590	590	6,0	mc. 0.0072
120303-025	● nero/black	x1	5	10	690	690	8,2	mc. 0.0098
120303-026	● nero/black	x1	5	10	790	790	10,7	mc. 0.0128
120305-024	● avorio/ivory ral 1013	x1	5	10	590	590	6,0	mc. 0.0072
120305-025	● avorio/ivory ral 1013	x1	5	10	690	690	8,2	mc. 0.0098
120305-026	● avorio/ivory ral 1013	x1	5	10	790	790	10,7	mc. 0.0128

05 tapas-piedino ellittico 40x20 h30

tapas-elliptical glide 40x20 h30

code	finishing	q.kit	kg.x1
134303-045	● nero/black	x4	0,0174 mc. 0.00003
134306-005	○ trasparente/transparent	x4	0,0174 mc. 0.00003



tapas

low table

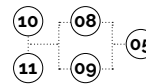
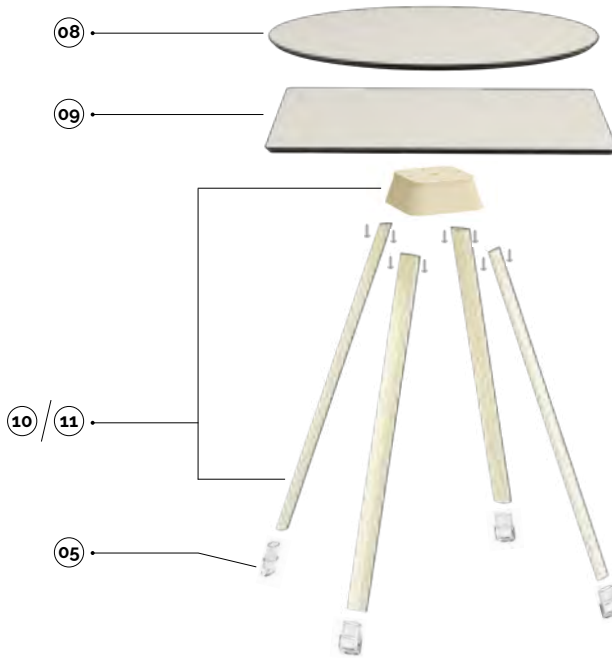

Si consigliano le seguenti misure di top:
The following top measures are recommended:

- low table: 690/ 790 mm

plastic colours

- avorio/ivory ral1013
- nero/black ral9005

Corten
* Specifica caratteristica del Corten è la variabilità nella tonalità della finitura.
* A specific characteristic of Corten is the variability in the tone of the finish.

main component sizes

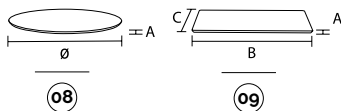
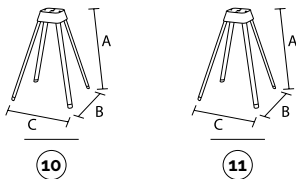

10 tapas-kit gambe tavolo basso con viti + supporto avorio r1013

tapas-kit low table legs with screws + table frame ivory r1013

code	finishing	q.kit	q.pack	a	b	c	kg.x1	vol.x1
110303-240	● nero/black	x1	2	730	530	530	5.11	mc. 0.01155
110304-240	● grigio/grey ig2621	x1	2	730	530	530	5.11	mc. 0.01155
110305-240	● avorio/ivory ral 1013	x1	2	730	530	530	5.11	mc. 0.01155
110307-240	● corten*	x1	2	730	530	530	5.11	mc. 0.01155
110310-240	● cromato/chrome	x1	2	730	530	530	5.11	mc. 0.01155
110303-242	● nero/black *per esterno/outdoor	x1	2	730	530	530	5.11	mc. 0.01155
110304-242	● grigio/grey ig2621 *per esterno/outdoor	x1	2	730	530	530	5.11	mc. 0.01155
110305-242	● avorio/ivory ral 1013 *per esterno/outdoor	x1	2	730	530	530	5.11	mc. 0.01155
110307-242	● corten* *per esterno/outdoor	x1	2	730	530	530	5.11	mc. 0.01155

11 tapas-kit gambe tavolo basso con viti + supporto nero

tapas-kit low table legs with screws + table frame black

code	finishing	q.kit	q.pack	a	b	c	kg.x1	vol.x1
110303-241	● nero/black	x1	2	730	530	530	5.11	mc. 0.01155
110304-241	● grigio/grey ig2621	x1	2	730	530	530	5.11	mc. 0.01155
110305-241	● avorio/ivory ral 1013	x1	2	730	530	530	5.11	mc. 0.01155
110307-241	● corten*	x1	2	730	530	530	5.11	mc. 0.01155
110310-241	● cromato/chrome	x1	2	730	530	530	5.11	mc. 0.01155
110303-243	● nero/black *per esterno/outdoor	x1	2	730	530	530	5.11	mc. 0.01155
110304-243	● grigio/grey ig2621 *per esterno/outdoor	x1	2	730	530	530	5.11	mc. 0.01155
110305-243	● avorio/ivory ral 1013 *per esterno/outdoor	x1	2	730	530	530	5.11	mc. 0.01155
110307-243	● corten* *per esterno/outdoor	x1	2	730	530	530	5.11	mc. 0.01155

08 tapas-top rotondo in hpl

tapas-round hpl top

code	finishing	q.kit	q.pack	a	ø	kg.x1	vol.x1
120303-021	● nero/black	x1	5	10	590	4.8	mc. 0.0072
120303-022	● nero/black	x1	5	10	690	6.6	mc. 0.0098
120303-023	● nero/black	x1	5	10	790	8.4	mc. 0.0128
120305-021	● avorio/ivory ral 1013	x1	5	10	590	4.8	mc. 0.0072
120305-022	● avorio/ivory ral 1013	x1	5	10	690	6.6	mc. 0.0098
120305-023	● avorio/ivory ral 1013	x1	5	10	790	8.4	mc. 0.0128

09 tapas-top quadrato in hpl

tapas-square hpl top

code	finishing	q.kit	q.pack	a	b	c	kg.x1	vol.x1
120303-024	● nero/black	x1	5	10	590	590	6.0	mc. 0.0072
120303-025	● nero/black	x1	5	10	690	690	8.2	mc. 0.0098
120303-026	● nero/black	x1	5	10	790	790	10.7	mc. 0.0128
120305-024	● avorio/ivory ral 1013	x1	5	10	590	590	6.0	mc. 0.0072
120305-025	● avorio/ivory ral 1013	x1	5	10	690	690	8.2	mc. 0.0098
120305-026	● avorio/ivory ral 1013	x1	5	10	790	790	10.7	mc. 0.0128

05 tapas-piedino ellittico 40x20 h30

tapas-elliptical glide 40x20 h30

code	finishing	q.kit	kg.x1
134303-045	● nero/black	x4	0.0174 mc. 0.00003
134306-005	○ trasparente/transparent	x4	0.0174 mc. 0.00003



tapas

coffee table

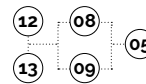
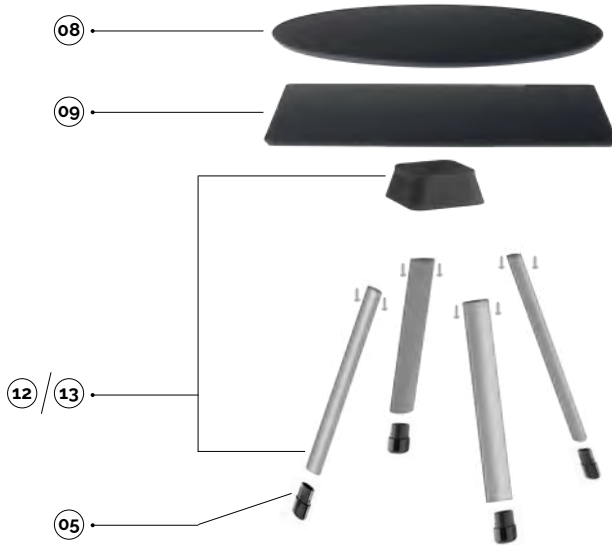

Si consigliano le seguenti misure di top:
The following top measures are recommended:

- coffee table: 590 mm

plastic colours

- avorio/ivory ral1013
- nero/black ral9005

Corten
 • *Specifica caratteristica del Corten è la variabilità nella tonalità della finitura.
 * A specific characteristic of Corten is the variability in the tone of the finish.

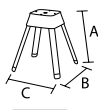
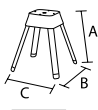

12

13

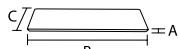
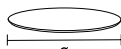

08

09

main component sizes

12 tapas-kit gambe tavolo caffè' con viti + supporto avorio r1013 tapas-kit coffee table legs with screws + table frame ivory r1013

code	finishing	q.kit	q.pack	a	b	c	kg.x1	vol.x1
110303-248	● nero/black	x1	2	390	353	353	2,92	mc. 0.006405
110304-248	● grigio/grey ig2621	x1	2	390	353	353	2,92	mc. 0.006405
110305-248	● avorio/ivory ral 1013	x1	2	390	353	353	2,92	mc. 0.006405
110307-248	● corten*	x1	2	390	353	353	2,92	mc. 0.006405
110310-248	● cromato/chrome	x1	2	390	353	353	2,92	mc. 0.006405
110303-250	● nero/black *per esterno/outdoor	x1	2	390	353	353	2,92	mc. 0.006405
110304-250	● grigio/grey ig2621 *per esterno/outdoor	x1	2	390	353	353	2,92	mc. 0.006405
110305-250	● avorio/ivory ral 1013 *per esterno/outdoor	x1	2	390	353	353	2,92	mc. 0.006405
110307-250	● corten* *per esterno/outdoor	x1	2	390	353	353	2,92	mc. 0.006405

13 tapas-kit gambe tavolo caffè' con viti + supporto nero tapas-kit coffee table legs with screws + table frame black

code	finishing	q.kit	q.pack	a	b	c	kg.x1	vol.x1
110303-249	● nero/black	x1	2	390	353	353	2,92	mc. 0.006405
110304-249	● grigio/grey ig2621	x1	2	390	353	353	2,92	mc. 0.006405
110305-249	● avorio/ivory ral 1013	x1	2	390	353	353	2,92	mc. 0.006405
110307-249	● corten*	x1	2	390	353	353	2,92	mc. 0.006405
110310-249	● cromato/chrome	x1	2	390	353	353	2,92	mc. 0.006405
110303-251	● nero/black *per esterno/outdoor	x1	2	390	353	353	2,92	mc. 0.006405
110304-251	● grigio/grey ig2621 *per esterno/outdoor	x1	2	390	353	353	2,92	mc. 0.006405
110305-251	● avorio/ivory ral1013 *per esterno/outdoor	x1	2	390	353	353	2,92	mc. 0.006405
110307-251	● corten* *per esterno/outdoor	x1	2	390	353	353	2,92	mc. 0.006405

08 tapas-top rotondo in hpl tapas-round hpl top

code	finishing	q.kit	q.pack	a	Ø	kg.x1	vol.x1
120303-021	● nero/black	x1	5	10	590	4,8	mc. 0.0072
120303-022	● nero/black	x1	5	10	690	6,6	mc. 0.0098
120303-023	● nero/black	x1	5	10	790	8,4	mc. 0.0128
120305-021	● avorio/ivory ral 1013	x1	5	10	590	4,8	mc. 0.0072
120305-022	● avorio/ivory ral 1013	x1	5	10	690	6,6	mc. 0.0098
120305-023	● avorio/ivory ral 1013	x1	5	10	790	8,4	mc. 0.0128

09 tapas-top quadrato in hpl tapas-square hpl top

code	finishing	q.kit	q.pack	a	b	c	kg.x1	vol.x1
120303-024	● nero/black	x1	5	10	590	590	6,0	mc. 0.0072
120303-025	● nero/black	x1	5	10	690	690	8,2	mc. 0.0098
120303-026	● nero/black	x1	5	10	790	790	10,7	mc. 0.0128
120305-024	● avorio/ivory ral 1013	x1	5	10	590	590	6,0	mc. 0.0072
120305-025	● avorio/ivory ral 1013	x1	5	10	690	690	8,2	mc. 0.0098
120305-026	● avorio/ivory ral 1013	x1	5	10	790	790	10,7	mc. 0.0128

05 tapas-piedino ellittico 40x20 h30 tapas-elliptical glide 40x20 h30

code	finishing	q.kit	kg.x1
134303-045	● nero/black	x4	0,0174 mc. 0.00003
134306-005	○ trasparente/transparent	x4	0,0174 mc. 0.00003



tapas

4-legs/metal shell



14 15 16

Corten ● *Specifica caratteristica del Corten è la variabilità nella tonalità della finitura.
* A specific characteristic of Corten is the variability in the tone of the finish.

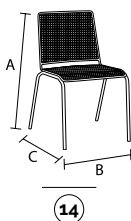

main component sizes

14 tapas-4 gambe con scocca in rete
tapas-4 legs with expanded metal shell

code	finishing		q.kit	q.pack	a	b	c	kg.x1	vol.x1
110105-367	● avorio/ivory	rat1013 *per esterno/outdoor	x1	1	805	535	580	5,6	mc. 0.024
110107-367	● corten*	*per esterno/outdoor	x1	1	805	535	580	5,6	mc. 0.024

15 tappi-puntale alettato testa sferica d.18 nero
inner caps-black spherical cap d.18

code	finishing	q.kit
134203-181	● nero/black	x4

16 paracolpi testa piatta duro 12x3,8x6x9 neutro
flat head buffer 12x3,8x6x9 neutral

code	finishing	q.kit
134006-102	○ neutro/neutral	x4

tapas

stool/metal shell



17 15 16

Corten • *Specifica caratteristica del Corten è la variabilità nella tonalità della finitura.
* A specific characteristic of Corten is the variability in the tone of the finish.

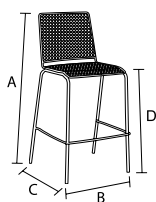

17

main component sizes

17 tapas-sgabello h750 con scocca in rete
tapas-stool h750 with expanded metal shell

code	finishing		q.kit	q.pack	a	b	c	d	kg.x1	vol.x1
110105-374	● avorio/ivory	ral.1013 *per esterno/outdoor	x1	1	1100	540	540	750	7,8	mc. 0,048
110107-374	● corten*	*per esterno/outdoor	x1	1	1100	540	540	750	7,8	mc. 0,048

15 tappi-puntale alettato testa sferica d.18 nero
inner caps-black spherical cap d.18

code	finishing	q.kit
134203-181	● nero/black	x4

16 paracolpi testa piatta duro 12x3,8x6x9 neutro
flat head buffer 12x3,8x6x9 neutral

code	finishing	q.kit
134006-102	○ neutro/neutral	x4

tapas

slide/metal shell



18 19

Corten • *Specifica caratteristica del Corten è la variabilità nella tonalità della finitura.
* A specific characteristic of Corten is the variability in the tone of the finish.

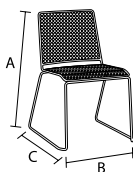

18

18 tapas-telaio a slitta in tondino d.12 con scocca in rete
tapas-slide wire frame d.12 with expanded metal shell

code	finishing		q.kit	q.pack	a	b	c	kg.x1	vol.x1
110505-504	● avorio/ivory	ral1013 *per esterno/outdoor	x1	1	805	520	595	7.7	mc. 0.036
110507-504	● corten*	*per esterno/outdoor	x1	1	805	520	595	7.7	mc. 0.036

19 confezione di basi a pinza antirotazione per tondino colore neutro
neutral clips base for wire d.11 package

code	finishing	q.kit	q.pack
137006-070	○ neutro/neutral	x4	200





spot



discover more about
Spot Collection

La gamba pieghevole pratica e innovativa. Senza struttura centrale, la gamba Spot nelle tre larghezze, garantisce la realizzazione di tavoli pieghevoli in svariate dimensioni.

Spot è la gambe ideale per qualsiasi ambiente Conference e Catering.

A practical and innovative folding leg. Spot legs come in three widths, and the absence of a central structure means folding tables in any top size can be produced without constraint.

Spot is the ideal leg for any Conference and Catering environment.

Plus

- È asimmetrica e ben si adatta a tutte le dimensioni di top.
- È pieghevole e come tale garantisce la totale accatastabilità dei tavoli.
- È dotata di piedini regolabili, rendendo facile adattare il tavolo in qualsiasi punto della sala.
- Certificazione EN 1730:2012 Livello 2.
- Sistema pieghevole brevettato.
- *Asymmetric design makes it ideal for all sizes of tops.*
- *Foldable, thus guaranteeing total stackability of tables.*
- *Equipped with adjustable feet, making it easy to adapt the table to any location in room.*
- *EN 1730:2012 Level 2 Certification.*
- *Patented folding system.*



designed by:
Esedra



**certified
product**



**patented
product**

spot

components

PATENTED
and CERTIFIED

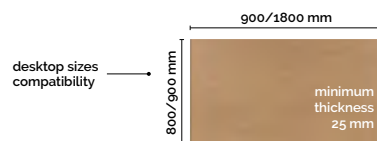
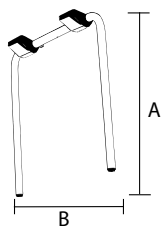

spot-gamba pieghevole d.35 h.700 per piano da 800 con accessori
spot-leg folding d.35 h.700 to plan for 800 with accessories

code	finishing	q.kit	q.pack	a	b	kg.x1	vol.x1
110304-014	● grigio/grey	x2	2	715	750	4,80	mc. 0.03
110305-014	○ bianco/white	x2	2	715	750	4,80	mc. 0.03
110310-090	● cromato/chrome	x2	2	715	750	4,80	mc. 0.03

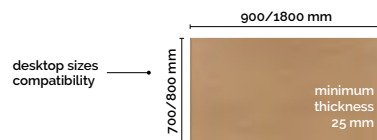
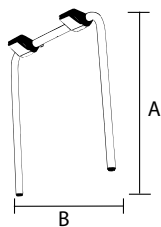

spot-gamba pieghevole d.35 h.700 per piano da 700 con accessori
spot-leg folding d.35 h.700 to plan for 700 with accessories

code	finishing	q.kit	q.pack	a	b	kg.x1	vol.x1
110304-038	● grigio/grey	x2	2	715	650	4,64	mc. 0.03
110305-013	○ bianco/white	x2	2	715	650	4,64	mc. 0.03
110310-093	● cromato/chrome	x2	2	715	650	4,64	mc. 0.03

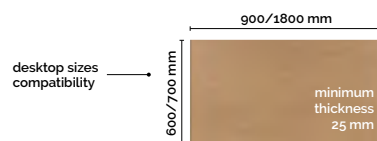
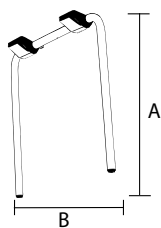

spot-gamba pieghevole d.35 h.700 per piano da 600 con accessori
spot-leg folding d.35 h.700 to plan for 600 with accessories

code	finishing	q.kit	q.pack	a	b	kg.x1	vol.x1
110304-039	● grigio/grey	x2	2	715	550	4,48	mc. 0.03
110305-039	○ bianco/white	x2	2	715	550	4,48	mc. 0.03
110310-096	● cromato/chrome	x2	2	715	550	4,48	mc. 0.03



gancio tipper-coppia ganci di unione per tavoli
tipper hook-pair of table linking device

code	finishing	q.kit	q.pack	kg.x1
134003-223	● nero rag./black	x2	20	0,005



spot-carrello portatavoli con accessori
spot-trolley for tables with accessories

code	finishing	kg.x1
110803-028	● nero/black	
110804-028	● grigio/grey	

spot

components

6 simple movements

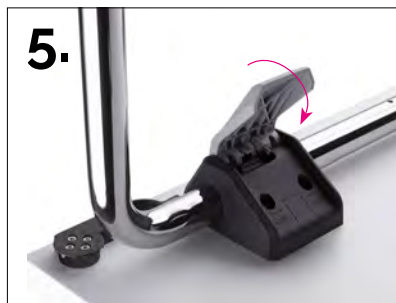

focus on: new table joining hook

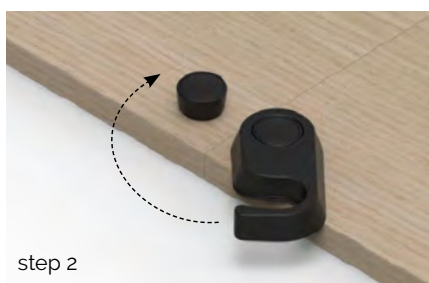
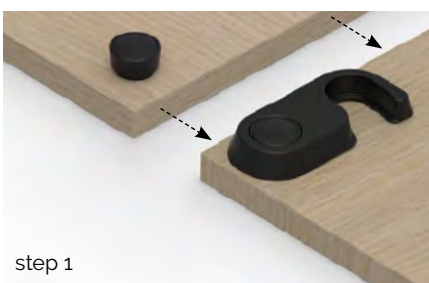



unyo



discover more about
Unyo Collection

La collezione Unyo offre un'ampia e completa gamma di divani composta sia da versioni stand-alone che da una versione modulare. Quest'ultima versione è dotata di un sistema di unione dei moduli brevettato basato su giunti in plastica pratici e facili da installare.

Caratterizzata da un design lineare e rigoroso, la collezione si distingue come un elemento d'arredo elegante e versatile, in grado di adattarsi ai più diversi contesti di utilizzo.

I moduli in poliuretano e i cuscini sono forniti grezzi, da tappezzare.

The Unyo collection offers a wide and comprehensive range of sofas consisting of both stand-alone and modular versions. This latter version features a patented module joining system based on plastic joints that are practical and easy to install.

Characterized by a linear and rigorous design, the collection stands out as an elegant and versatile piece of furniture that can adapt to the most diverse contexts of use.

Polyurethane modules and cushions are supplied unfinished, to be upholstered.

Plus

- Versioni stand-alone e modulari.
- Sistema di unione modulare brevettato.
- Moduli in poliuretano senza struttura metallica interna.
- Poliuretano in Classe IM.
- *Stand-alone and modular versions.*
- *Patented modular joining system.*
- *Polyurethane modules without internal metal structure.*
- *IM Class Polyurethane.*



designed by:
R&D Alba



**patented
product**

unyo

armchair

single frame version

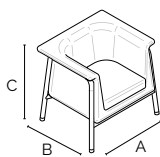

01

01 unyo.poltrona - telaio saldato + piedini + viti + poliuretano + cuscino + pannelli di legno
unyo.armchair - welded frame + glides + screws + polyurethane + cushion + wooden panels

code	finishing		a	b	c
111605-095	○ bianco liscio opaco/white glossy matt	ral 9010	824	697	751
111603-095	● nero ragg./black rough	ral 9005	824	697	751
111610-095	● cromo lucido/chrome		824	697	751
111605-094	● beige/beige	ral 1019	824	697	751

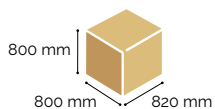
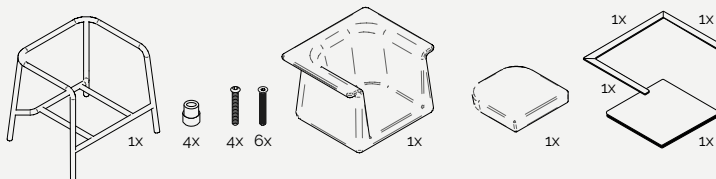

unyo

sofa 2 seater

single frame version

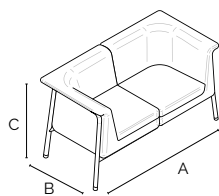
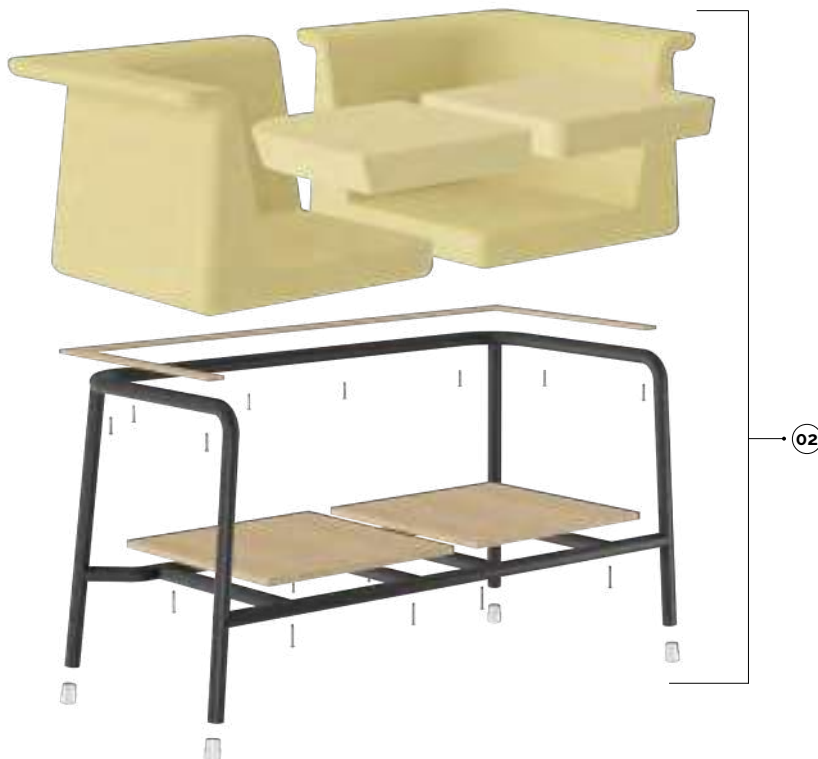

02

02 unyo.divano 2 posti - telaio saldato + piedini + viti + poliuretani + cuscini + pannelli di legno
 unyo.sofa 2 seater - welded frame + glides + screws + polyurethane + cushions + wooden panels

code	finishing		a	b	c
111605-096	○ bianco liscio opaco/white glossy matt	ral 9010	1424	700	751
111603-096	● nero ragg./black rough	ral 9005	1424	700	751
111610-096	● cromo lucido/chrome		1424	700	751
111605-097	● beige/beige	ral 1019	1424	700	751

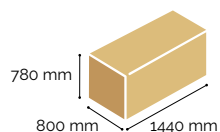
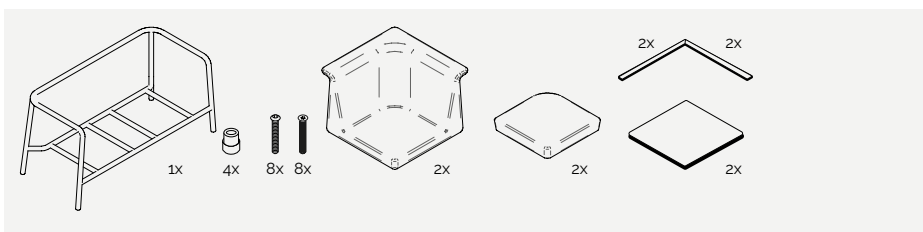

unyo

bench

single frame version

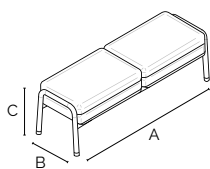

03

03 unyo.panca 2 posti - telaio saldato • piedini • viti • cuscini • pannelli di legno
 unyo.bench 2 seater - welded frame + feet + screws + cushions + wooden panels

code	finishing		a	b	c
111605-111	○ bianco liscio opaco/white glossy matt	ral 9010	1370	430	440
111603-111	● nero ragg./black rough	ral 9005	1370	430	440
111610-111	● cromo lucido/chrome		1370	430	440
111605-112	● beige/beige	ral 1019	1370	430	440

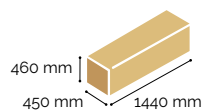
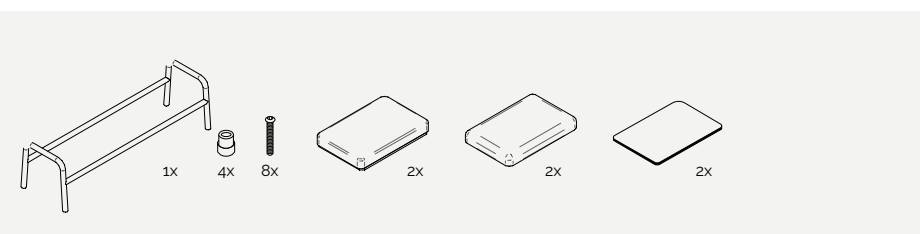

unyo

right corner module

modular version

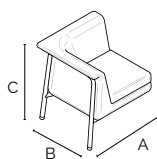
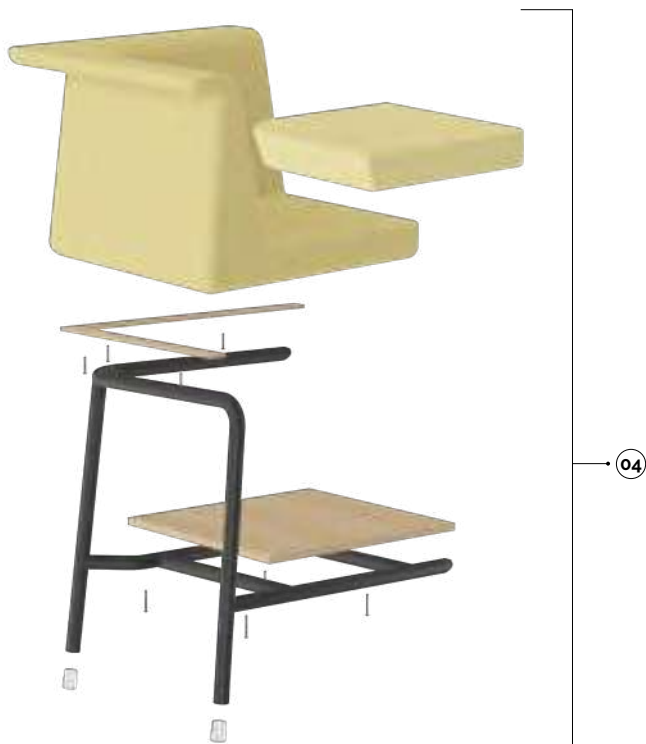

04

04 unyo.modulo angolare dx - kit telaio + piedini + viti + poliuretano + cuscino + pannelli di legno
 unyo.right corner module - frame kit + glides + screws + polyurethane + cushion + wooden panels

code	finishing		a	b	c
111605-102	○ bianco liscio opaco/white glossy matt	ral 9010	712	700	751
111603-102	● nero ragg./black rough	ral 9005	712	700	751
111610-102	● cromo lucido/chrome		712	700	751
111605-101	● beige/beige	ral 1019	712	700	751

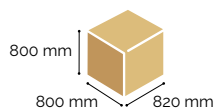
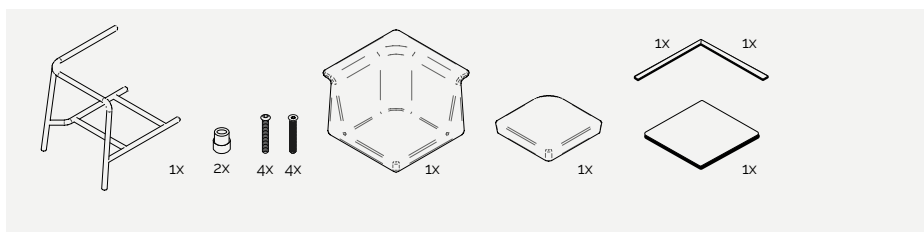

unyo

left corner module

modular version



05

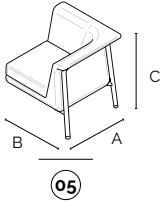

05 unyo.modulo angolare sx - kit telaio • piedini • viti • poliuretano • cuscino • pannelli di legno
 unyo.left corner module - frame kit + glides + screws + polyurethane + cushion + wooden panels

code	finishing		a	b	c
111605-103	○ bianco liscio opaco/white glossy matt	ral 9010	700	712	751
111603-103	● nero ragg./black rough	ral 9005	700	712	751
111610-103	● cromo lucido/chrome		700	712	751
111605-104	● beige/beige	ral 1019	700	712	751

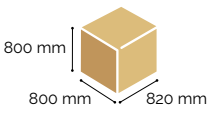
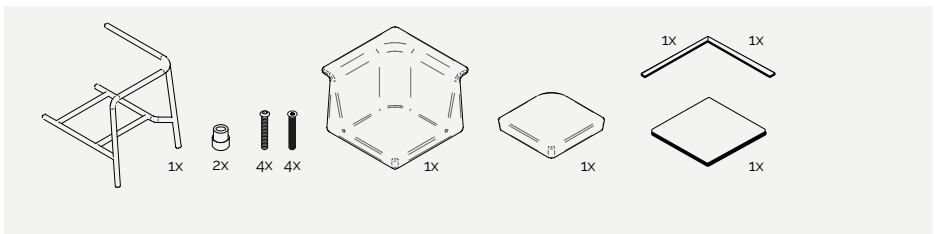

unyo

central module

modular version



06

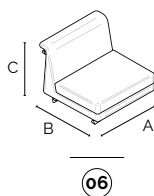

06

06 unyo.modulo centrale - kit telaio + viti + poliuretano + cuscino + pannelli di legno
 unyo.central module - frame kit + screws + polyurethane + cushion + wooden panels

code	finishing		a	b	c
111605-105	○ bianco liscio opaco/white glossy matt	ral 9010	700	700	525
111603-105	● nero ragg./black rough	ral 9005	700	700	525
111610-105	● cromo lucido/chrome		700	700	525
111605-106	● beige/beige	ral 1019	700	700	525

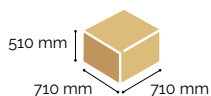
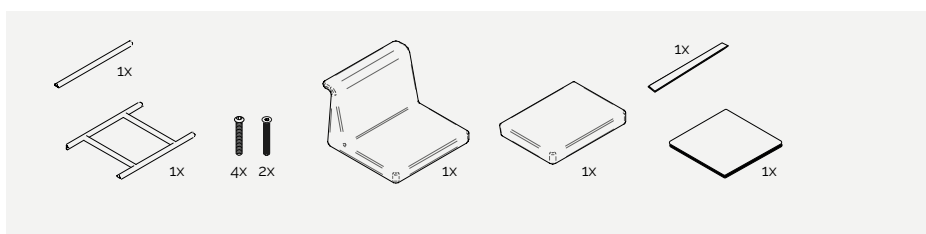

unyo

open curved module

modular version

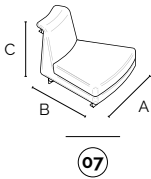

07 unyo.modulo curvo aperto - kit telaio + viti + poliuretano + cuscino + pannelli di legno
 unyo.open curved module - frame kit + screws + polyurethane + cushion + wooden panels

code	finishing		a	b	c
111605-107	○ bianco liscio opaco/white glossy matt	ral 9010	659	714	525
111603-107	● nero ragg./black rough	ral 9005	659	714	525
111610-107	● cromo lucido/chrome		659	714	525
111605-108	● beige/beige	ral 1019	659	714	525

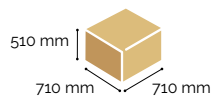
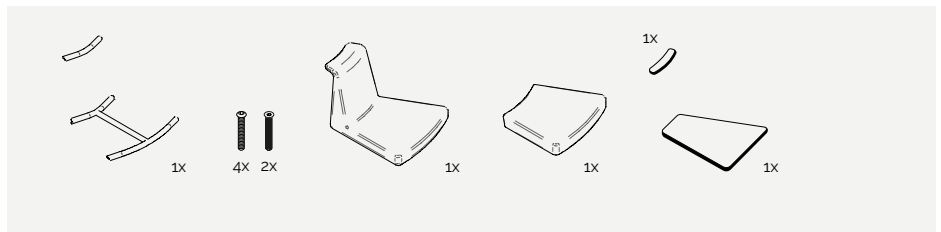

unyo

closed curved module

modular version

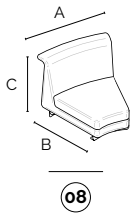
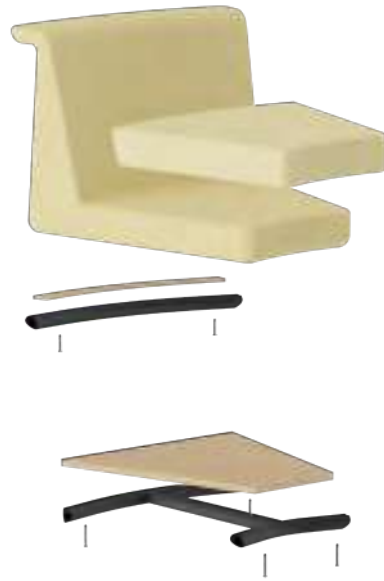

08 unyo.modulo curvo chiuso - kit telaio + viti + poliuretano + cuscino + pannelli di legno
 unyo.closed curved module - frame kit + screws + polyurethane + cushion + wooden panels

code	finishing		a	b	c
111605-109	○ bianco liscio opaco/white glossy matt	ral 9010	659	714	525
111603-109	● nero ragg./black rough	ral 9005	659	714	525
111610-109	● cromo lucido/chrome		659	714	525
111605-110	● beige/beige	ral 1019	659	714	525

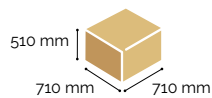
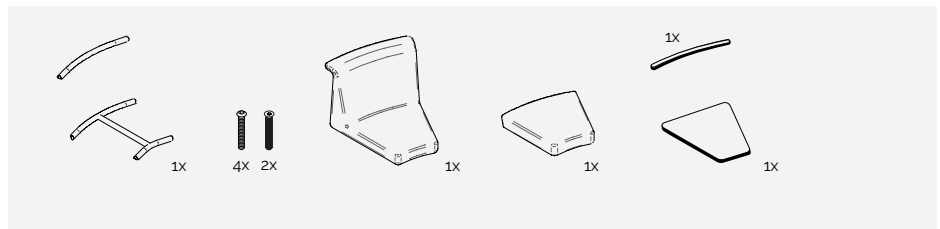

unyo

restart module

modular version

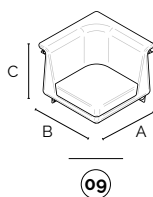

09 unyo.modulo ripartenza - telaio saldato + piedino + viti + poliuretano + cuscini + pannelli di legno
 unyo.restart module - welded frame + glides + screws + polyurethane + cushions + wooden panels

code	finishing		a	b	c
111605-098	○ bianco liscio opaco/white glossy matt	ral 9010	700	700	751
111603-098	● nero ragg./black rough	ral 9005	700	700	751
111610-098	● cromo lucido/chrome		700	700	751
111605-099	● beige/beige	ral 1019	700	700	751

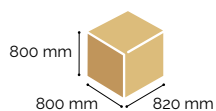
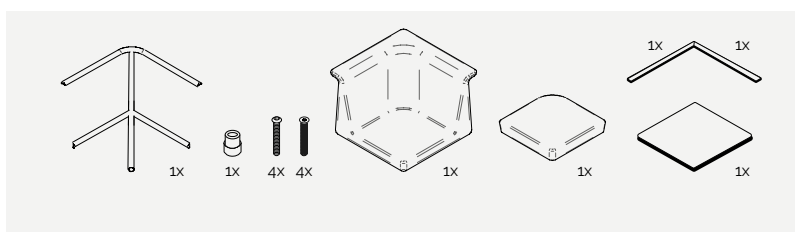

unyo

central legs

modular version

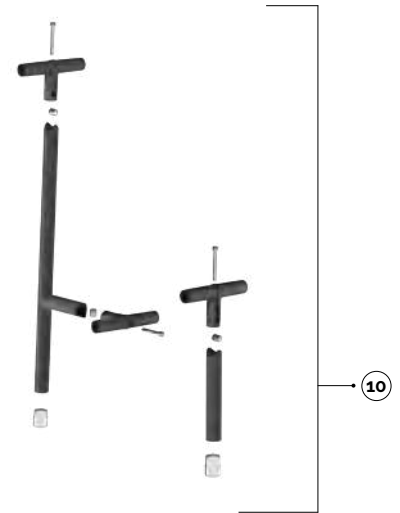
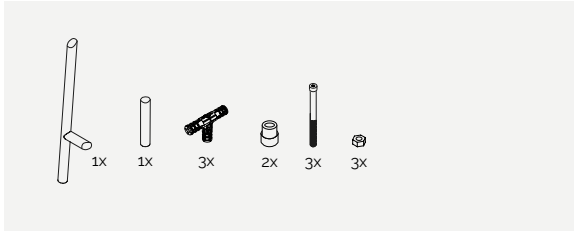

10

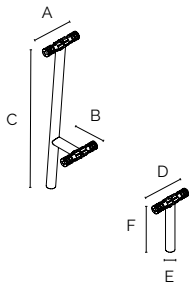

10

10 unyo.gambe centrali - kit gambe con giunti + piedini + viti
unyo.central legs - leg kit with joints + glides + screws

code	finishing		a	b	c	d	e	f
111605-090	○ bianco liscio opaco/white glossy matt	ral 9010	160	164	709	160	35	260
111603-090	● nero ragg./black rough	ral 9005	160	164	709	160	35	260
111610-090	● cromo lucido/chrome		160	164	709	160	35	260
111605-091	● beige/beige	ral 1019	160	164	709	160	35	260

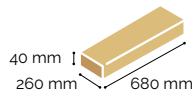

unyo

corner legs

modular version

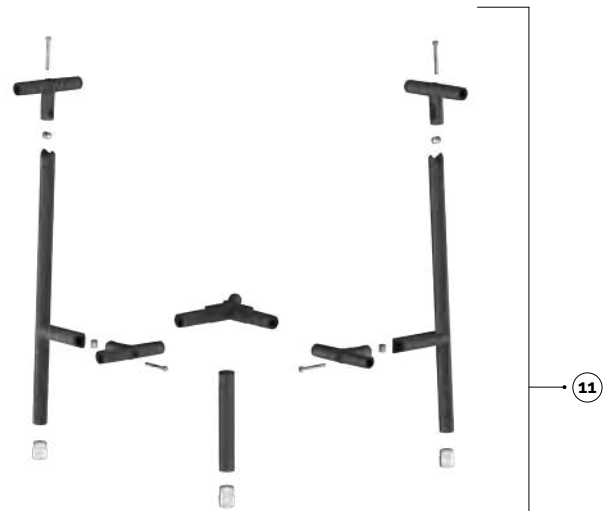
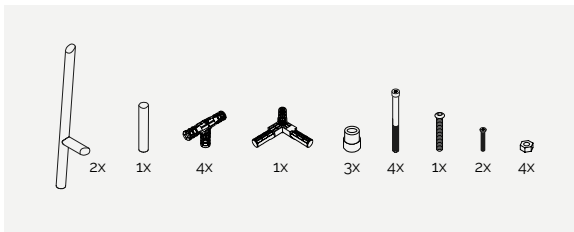

11

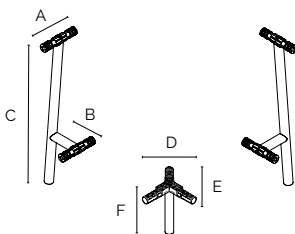

11

11 unyo.gambe angolari - kit gambe con giunti + piedini + viti
unyo.corner legs - leg kit with joints + glides + screws

code	finishing		a	b	c	d	e	f
111605-092	○ bianco liscio opaco/white glossy matt	ral 9010	160	164	709	215	222	265
111603-092	● nero ragg./black rough	ral 9005	160	164	709	215	222	265
111610-092	● cromo lucido/chrome		160	164	709	215	222	265
111605-093	● beige/beige	ral 1019	160	164	709	215	222	265

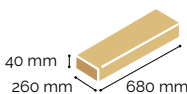



modula



discover more about
Modula Collection

Modula abbina il più classico concetto di libreria, alla versatilità di utilizzo di una moderna scaffalatura modulare, costituendo un sistema d'arredo versatile e pratico.

Grazie alle sue caratteristiche modulari, la collezione Modula è in grado di adattarsi a diverse esigenze di arredo, sia in contesti professionali e commerciali, che domestici.

Modula combines the most classic bookcase concept, with the versatility of use of a modern modular shelving unit, resulting in a versatile and practical furniture system.

Thanks to its modular features, the Modula collection is able to adapt to different furnishing needs, both in professional and commercial settings, as well as in domestic environments.

Plus

- Adatta per installazioni a soffitto o a parete.
- Sistema di supporto mensole brevettato.
- Certificazione EN16122:2021 + AC:2015.
- Elevata versatilità modulare.
- Montanti in alluminio.
- *Suitable for ceiling or wall mounting.*
- *Patented shelf support system.*
- *EN16122:2021 + AC:2015 Certification.*
- *Great modular versatility.*
- *Aluminum uprights.*



designed by:
R&D Alba



**patented
product**



**certified
product**

modula

single column

wall version

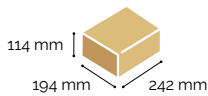

03

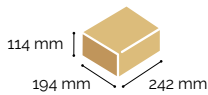

04

2 kit supporti mensola x imballo
2 shelf support kits x packaging

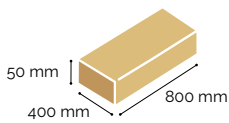

05 07

2 mensole x imballo
2 shelves x packaging

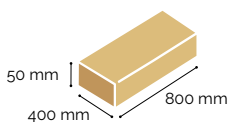

06 08

4 mensole x imballo
4 shelves x packaging

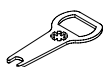

21 utensile multifunzione
multifunctional tool

code finishing
110803-415 ● zincato/zinc plated

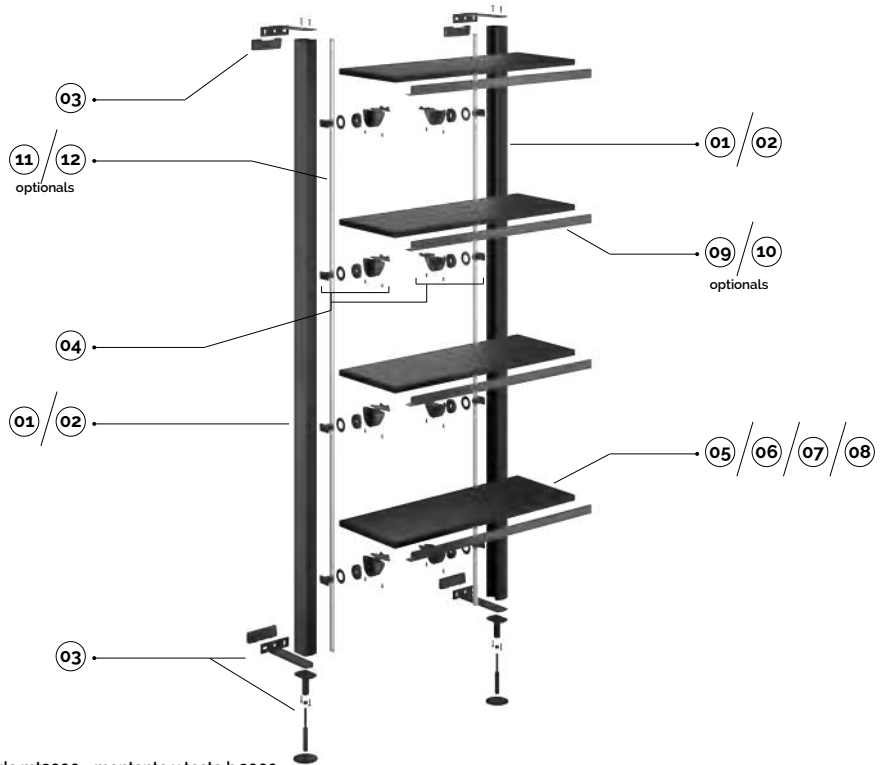

01 modula.mt2000 - montante x testa h.2000
modula.mt2000 - side upright h.2000

code	finishing		a	b	c
110805-402	○ bianco gofrato/white rough	ral 9010	71	51	2000
110803-402	● nero gofrato/black rough	ral 9005	71	51	2000

02 modula.mt1000 - montante x testa h.1000
modula.mt1000 - side upright h.1000

code	finishing		a	b	c
110805-403	○ bianco gofrato/white rough	ral 9010	71	51	1000
110803-403	● nero gofrato/black rough	ral 9005	71	51	1000

03 modula.fp. - kit x parete accessori
modula.fp. - kit x wall accessories

code	finishing				
110805-419	○ bianco gofrato/white rough	ral 9010			
110803-419	● nero gofrato/black rough	ral 9005			

04 modula.supm. - kit supporti mensola
modula.supm. - kit shelf support

code	finishing				
110805-423	○ bianco gofrato/white rough	ral 9010			
110803-423	● nero gofrato/black rough	ral 9005			

05 modula.mensl. - kit mensola nobilitato 790x300 + viti
modula.mensl. - kit melamine shelf 790x300 + screws

code	finishing		a	b	c
110805-424	○ bianco/white		790	300	20
110803-424	● nero/black		790	300	20

06 modula.mensl. - kit mensola nobilitato 368,5x300 + viti
modula.mensl. - kit melamine shelf 368,5x300 + screws

code	finishing		a	b	c
110805-425	○ bianco/white		368,5	300	20
110803-425	● nero/black		368,5	300	20

07 modula.mensm. - kit mensola metallo 790x300 + viti
modula.mensm. - kit metal shelf 790x300 + screws

code	finishing		a	b	c	d
110805-426	○ bianco gofrato/white rough	ral 9010	790	300	17,5	30
110803-426	● nero gofrato/black rough	ral 9005	790	300	17,5	30

08 modula.mensm. - kit mensola metallo 368,5x300 + viti
modula.mensm. - kit metal shelf 368,5x300 + screws

code	finishing		a	b	c	d
110805-427	○ bianco gofrato/white rough	ral 9010	368,5	300	17,5	30
110803-427	● nero gofrato/black rough	ral 9005	368,5	300	17,5	30

09 modula.l79 - profilo in alluminio per mensole in legno L790 mm + viti
modula.l79 - aluminum profile for melamine shelf L790 mm + screws

code	finishing		a	b	c
110805-032	○ bianco gofrato/white rough	ral 9010	790	30	30
110803-032	● nero gofrato/black rough	ral 9005	790	30	30
110804-032	● alluminio anodizzato/anodised aluminum		790	30	30

10 modula.l37 - profilo in alluminio per mensole in legno L368,5 mm + viti
modula.l37 - aluminum profile for melamine shelf L368,5 mm + screws

code	finishing		a	b	c
110805-031	○ bianco gofrato/white rough	ral 9010	368,5	30	30
110803-031	● nero gofrato/black rough	ral 9005	368,5	30	30
110804-031	● alluminio anodizzato/anodised aluminum		368,5	30	30

11 modula.o2000 - profilo opalino x copertura h.2000
modula.o2000 - plastic cover for led h.2000

code	finishing		a	b	c
130805-429	○ opalino/white transparent		7,5	15,2	2000

12 modula.o1000 - profilo opalino x copertura h.1000
modula.o1000 - plastic cover for led h.1000

code	finishing		a	b	c
130805-428	○ opalino/white transparent		7,5	15,2	1000

modula

multiple columns

wall version

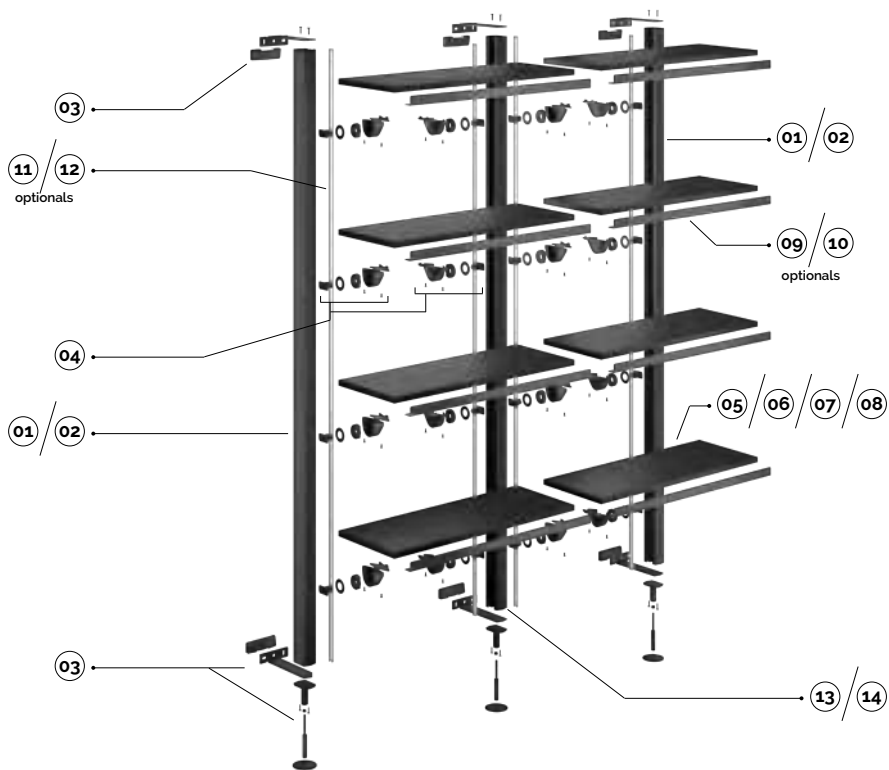

for the components below, see previous page

- 01 02 03 04 05 06
07 08 09 10 11 12

13 modula.mi2000 - montante centrale h.2000
modula.mi2000 - central upright h.2000

code	finishing		a	b	c
110805-405	○ bianco gofrato/white rough	ral 9010	71	51	2000
110803-405	● nero gofrato/black rough	ral 9005	71	51	2000

14 modula.mi1000 - montante centrale h.1000
modula.mi1000 - central upright h.1000

code	finishing		a	b	c
110805-406	○ bianco gofrato/white rough	ral 9010	71	51	1000
110803-406	● nero gofrato/black rough	ral 9005	71	51	1000



kit
wall version

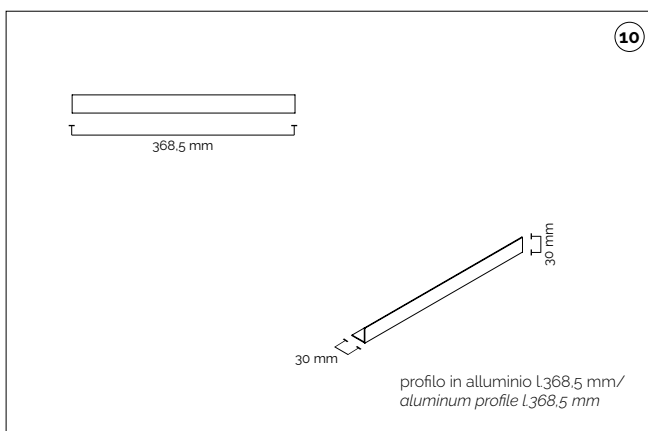
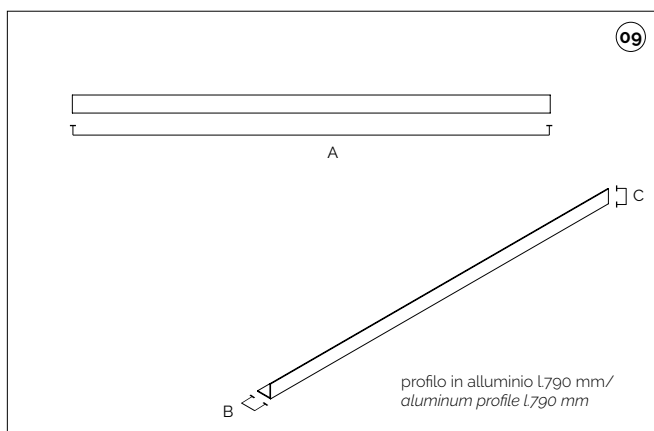
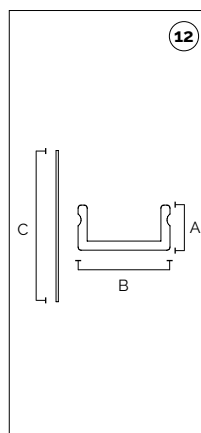
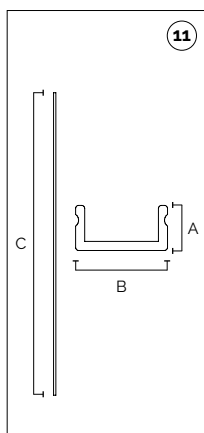
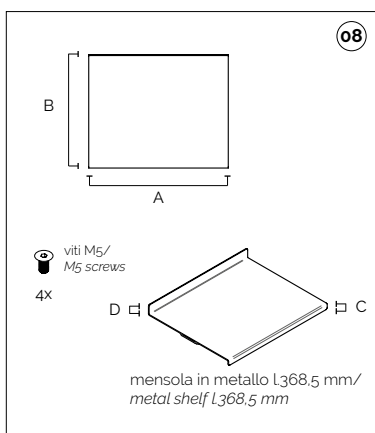
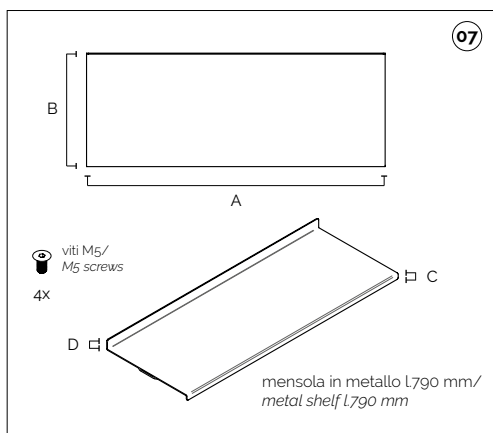
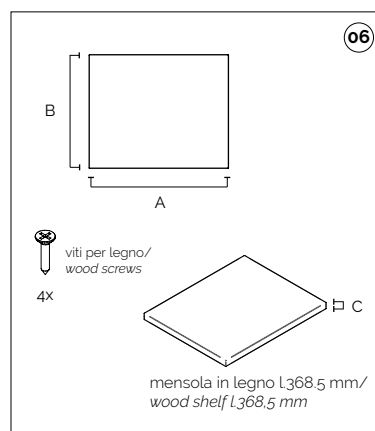
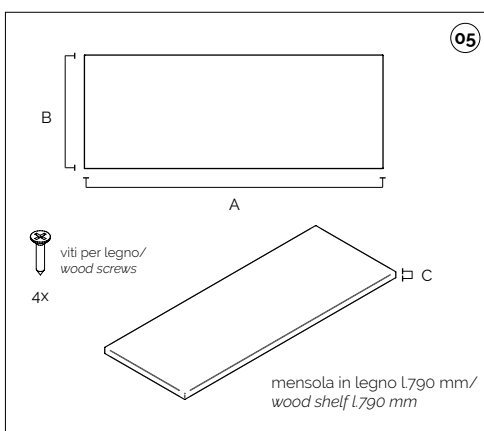
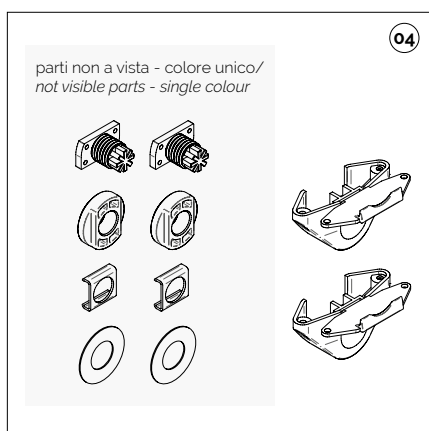
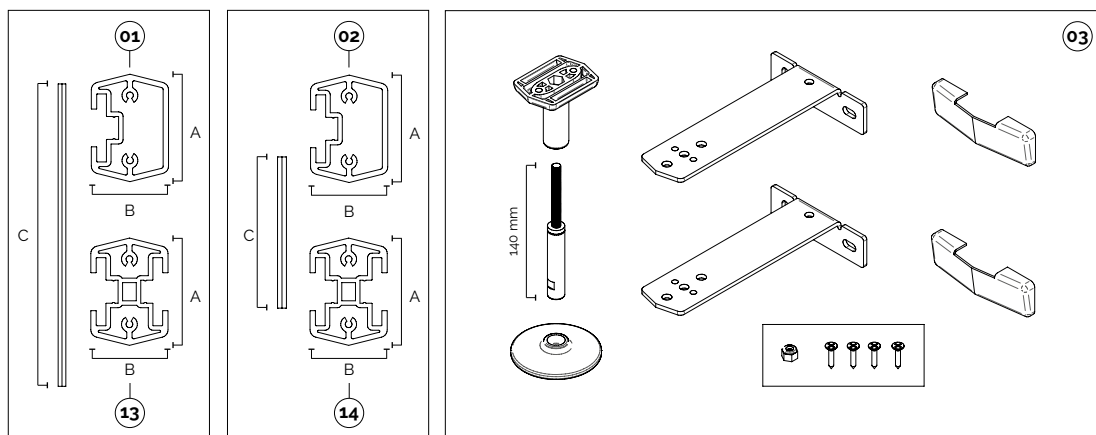



modula

single column

ceiling version

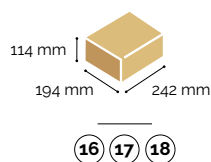
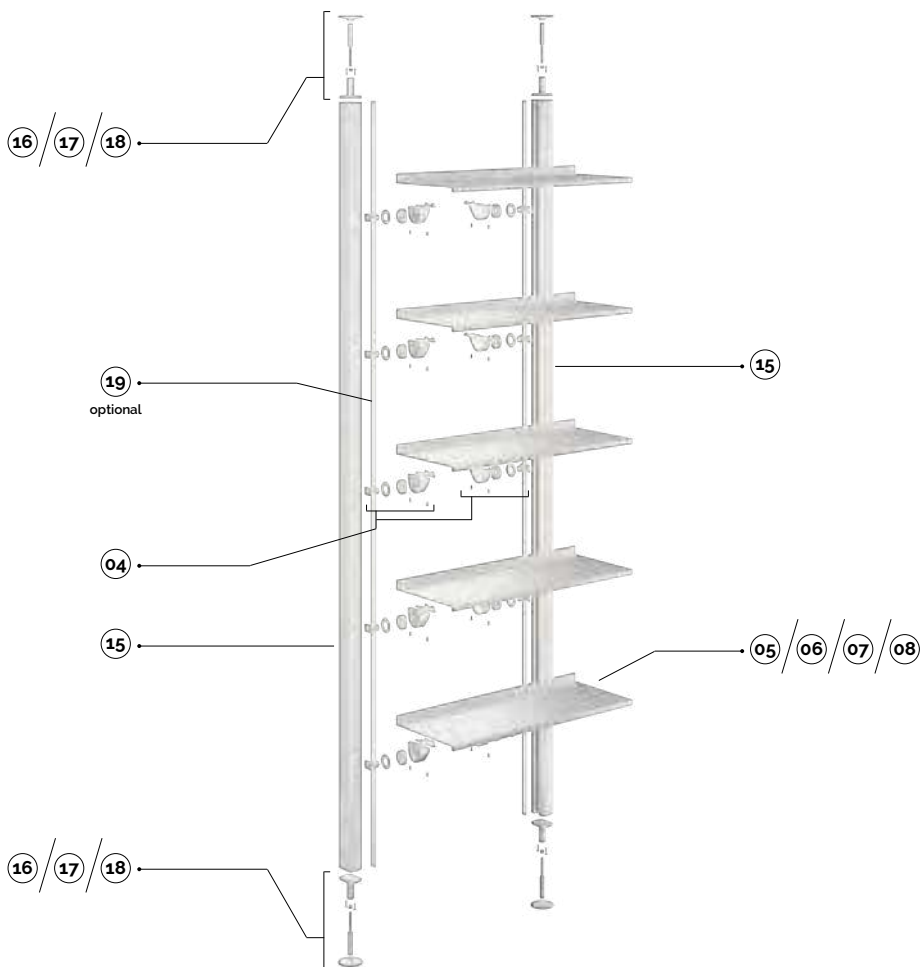

15 modula.mt2500 - montante x testa h.2500
modula.mt2500 - side upright h.2500

code	finishing		a	b	c
110805-401	○ bianco gofrato/white rough	ral 9010	71	51	2500
110803-401	● nero gofrato/black rough	ral 9005	71	51	2500

16 modula.fs1. - kit x soffitto mis.1 accessori
modula.fs1. - kit x ceiling dim.1 accessories

code	finishing		a	ø
110805-420	○ bianco gofrato/white rough	ral 9010	142	15,3
110803-420	● nero gofrato/black rough	ral 9005	142	15,3

17 modula.fs2. - kit x soffitto mis.2 accessori
modula.fs2. - kit x ceiling dim.2 accessories

code	finishing		a	ø
110805-421	○ bianco gofrato/white rough	ral 9010	192	15,3
110803-421	● nero gofrato/black rough	ral 9005	192	15,3

18 modula.fs3. - kit x soffitto mis.3 accessori
modula.fs3. - kit x ceiling dim.3 accessories

code	finishing		a	ø
110805-422	○ bianco gofrato/white rough	ral 9010	242	15,3
110803-422	● nero gofrato/black rough	ral 9005	242	15,3

19 modula.o2500 - profilo opalino x copertura h.2500
modula.o2500 - plastic cover for led h.2500

code	finishing		a	b	c
130805-430	○ opalino/white transparent		7,5	15,2	2500

for the components below, see previous pages

04 05 06 07 08

modula

multiple columns

ceiling version

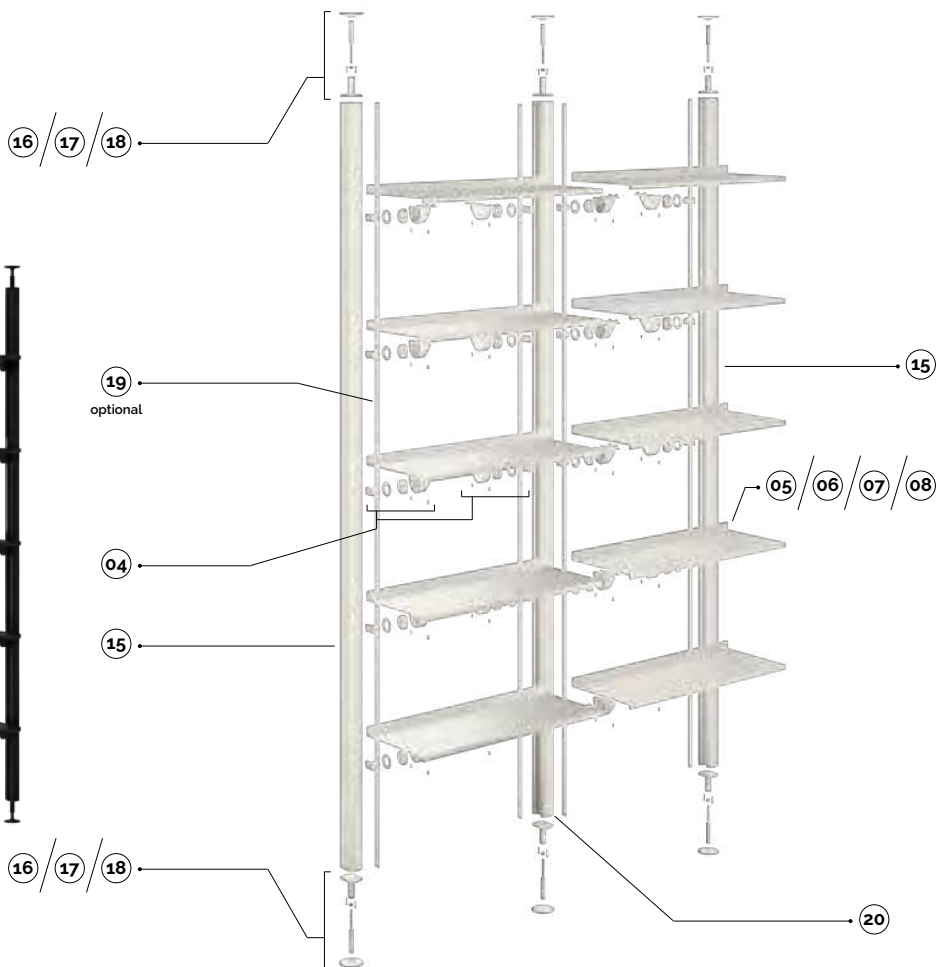
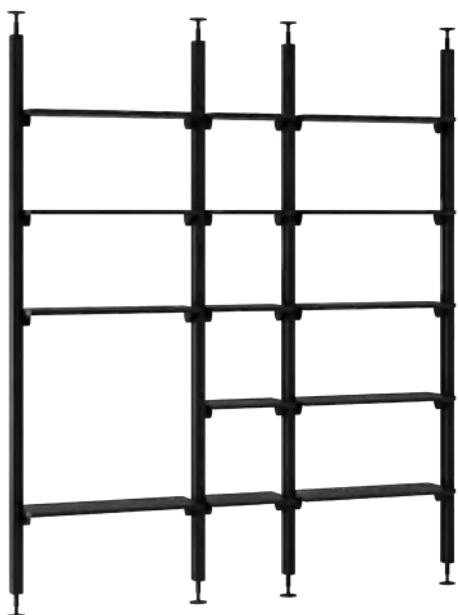

for the components below, see previous pages

15 16 17 18 19

04 05 06 07 08

20 modula.mi2500 - montante centrale h.2500
modula.mi2500 - central upright h.2500

code	finishing		a	b	c
110805-404	○ bianco gofrato/white rough	ral 9010	71	51	2500
110803-404	● nero gofrato/black rough	ral 9005	71	51	2500

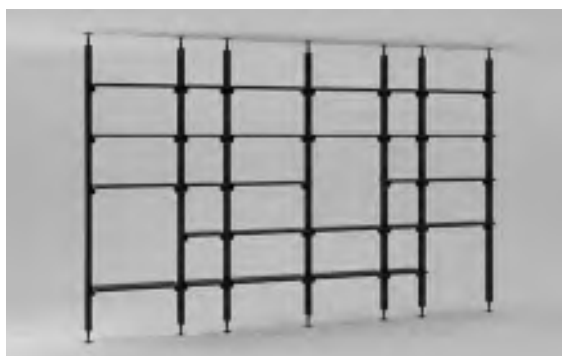

kit
ceiling version

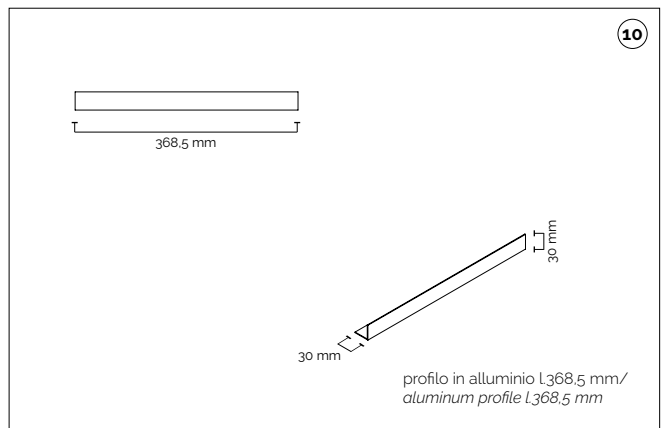
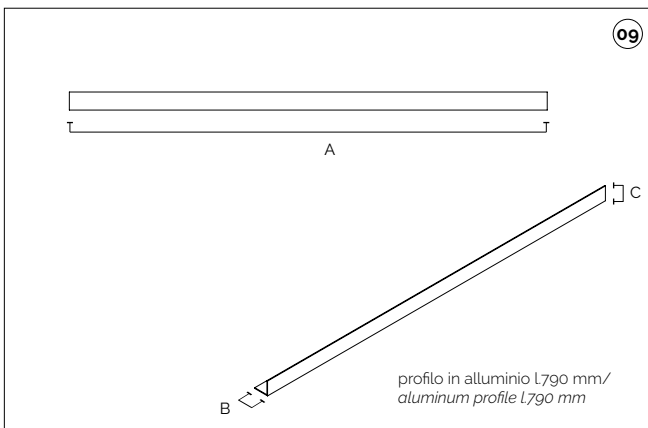
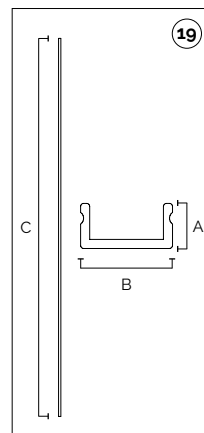
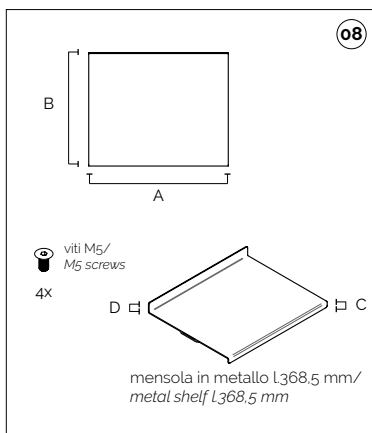
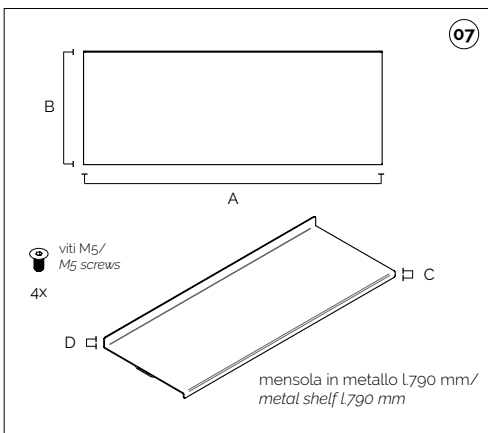
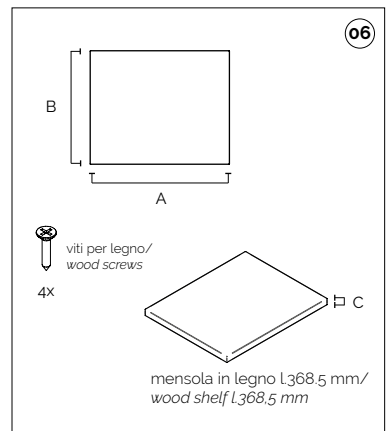
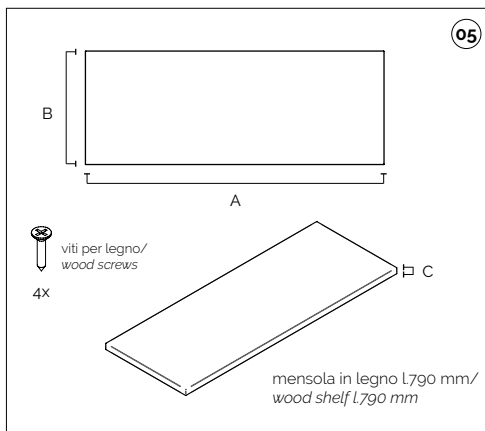
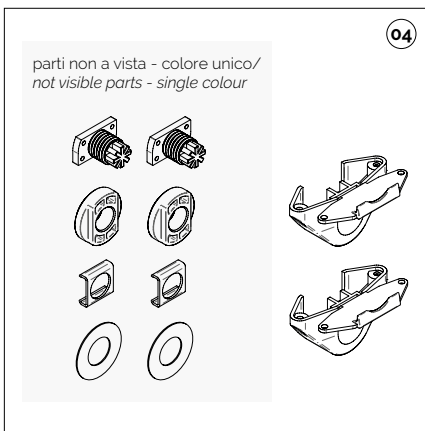
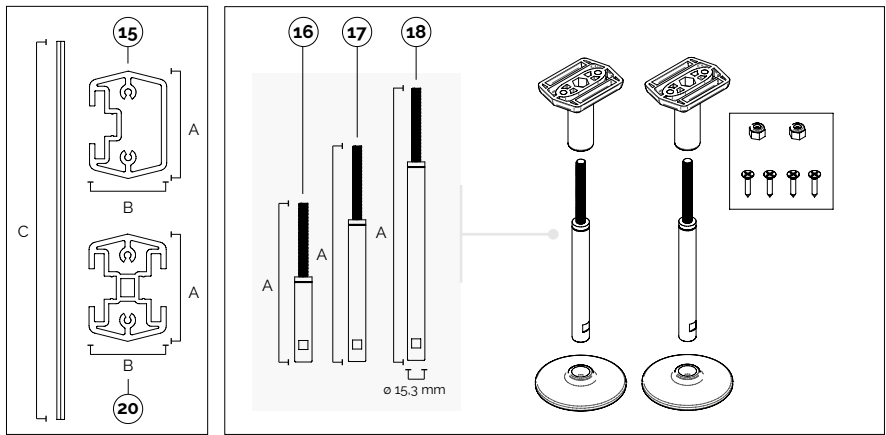

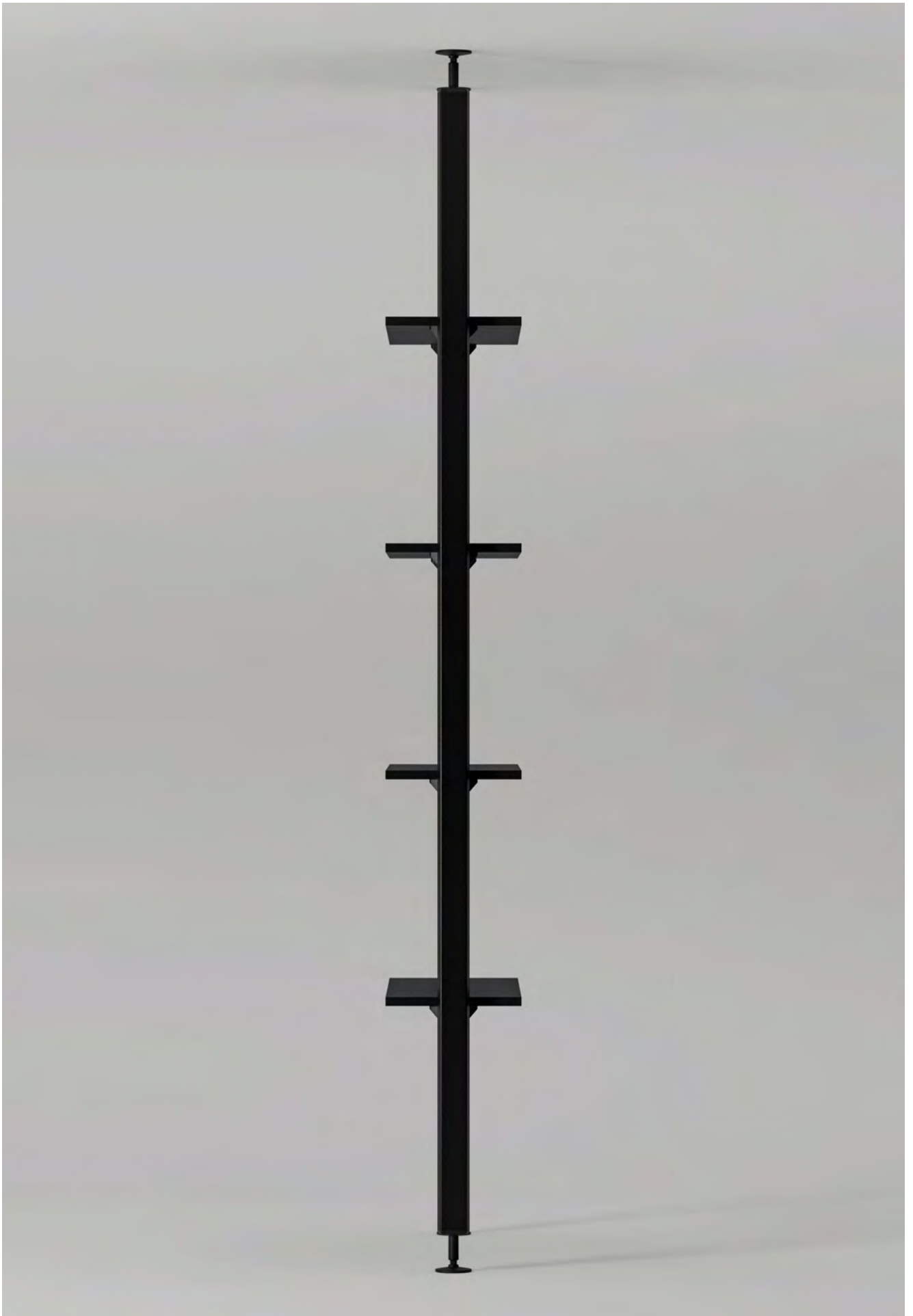



wing



discover more about
Wing Collection

Wing. 3 grandi vantaggi in una seduta. Design distintivo e massimo comfort grazie soprattutto alle due caratteristiche ali. Estremamente funzionale e versatile prevede 5 varianti colore della monoscocca e diversi telai e accessori opzionabili.

Wing è la nuova proposta di seduta per l'ambiente Contract e l'ambiente Home.

Wing: 3 great advantages in one chair. Distinctive design and maximum comfort thanks in particular to the two characteristic wings. Extremely functional and versatile, available in 5 colour variants for the monocoque and various options for frames and accessories.

Wing is the new chair designed for Contract and Home environments.

Plus

- Grande impatto estetico, grazie al suo design distintivo.
- Estremo comfort, grazie alla generosa monoscocca.
- Facile da pulire e da spostare.
- *Great aesthetic impact, thanks to its distinctive design.*
- *Outstanding comfort, thanks to the generous monocoque.*
- *Easy to clean and move.*



designed by:
Shannon Sadler



**outdoor
ready**



**UV plastic
protection**

wing

slide



plastic colours

- avorio/ivory ral1013
- corallo/coral 1797u
- nocciola/hazelnut 2312u
- nero/black ral9005
- blu/blue 541u

01 02 03 04 05 07 08
optional

main component sizes

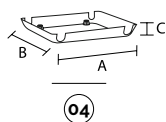
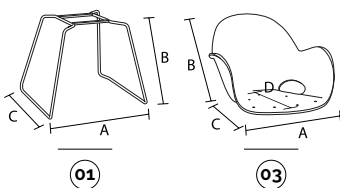

optionals

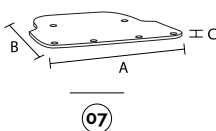

01 telaio a slitta in tondino d.12
slide wire frame d.12

code	finishing	q.kit	q.pack	a	b	c	kg.x1	vol.x1
113410-400	● cromato/chrome	x1	100	540	525	440	3,54	mc. 0.026

02 confezione di basi a pinza antirotazione per tondino colore neutro
neutral clips base for wire d.11 package

code	finishing	q.kit	q.pack
137006-070	○ neutro/neutral	x4	200

03 scocca a pozzetto con braccioli (anti-uv)
plastic shell with arms (anti-uv)

code	finishing	q.kit	q.pack	a	b	c	d	kg.x1	vol.x1
133905-042	● avorio/ivory ral1013	x1	5	570	430	590	410	2,9	mc. 0.041

04 copertina in plastica (anti-uv)
plastic cover (anti-uv)

code	finishing	q.kit	q.pack	a	b	c	kg.x1
132205-039	● avorio/ivory ral1013	x1	25	265	250	40	0,15

05 vite tsp+ m6x25 zincata bianca (vite per fissaggio scocca con copertina) x 4g sl cv pc gir
screw tsp+ m6x25 white zinc (screw for fix shell with cover)

code	finishing	q.kit
117711-199	● zincata bianca/white zinc	x4

07 pannello sedile multistrato
plywood seat panel

code	finishing	q.kit	q.pack	a	b	c	kg.x1	vol.x1
122207-023	● faggio/plywood	x1	20	376	370	5	0,3	mc. 0.0019

08 vite tbcl m4x12 zincata bianca (vite per fissaggio pannello sedile)
screw tbcl m4x12 white zinc (screw for fix seat panel)

code	finishing	q.kit
117711-126	● zincata bianca/white zinc	x6



for all colour codes, see page 151

wing

slide

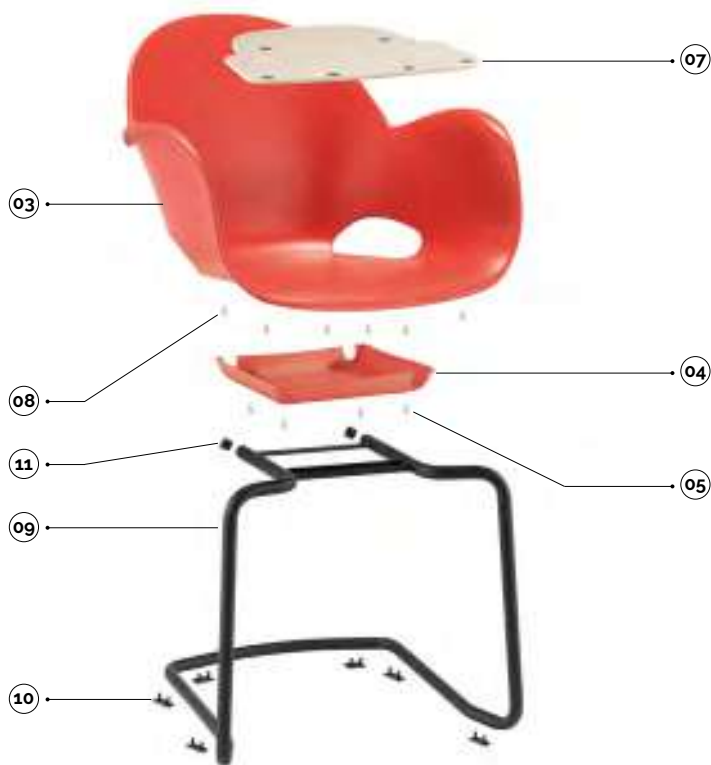

09 10 03 04 05 07 08 11
optional

plastic colours

- avorio/ivory ral1013
- corallo/coral 1797u
- nocciola/hazelnut 2312u
- nero/black ral9005
- blu/blue 541u

main component sizes

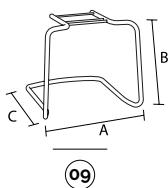

09 base a slitta in tubo d.22 senza tappi
cantilever frames d.22 without caps

code	finishing	q.kit	q.pack	a	b	c	kg.x1	vol.x1
110503-480	● nero/black	x1	64	510	450	500	3,77	mc. 0.0313
110505-480	● avorio/ivory ral1013	x1	64	510	450	500	3,77	mc. 0.0313
110504-480	● grigio/grey	x1	64	510	450	500	3,77	mc. 0.0313
110510-480	● cromato/chrome	x1	64	510	450	500	3,77	mc. 0.0313

10 pinza due pioli in polietilene nera
two pins pliers in black polythene

code	finishing	q.kit	kg.x1
134003-003	● nero/black	x6	0,05

11 tappo copritesta ø20 per cantilever
cover head cap ø20 for cantilever

code	finishing	q.kit
134103-200	● nero/black	x2

for the components below, see previous page

03 04 05 07 08



for all colour codes, see page 151

wing

4-legs



plastic colours

- avorio/ivory ral1013
- corallo/coral 1797u
- nocciola/hazelnut 2312u
- nero/black ral9005
- blu/blue 541u

main component sizes

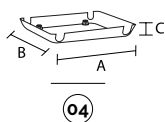
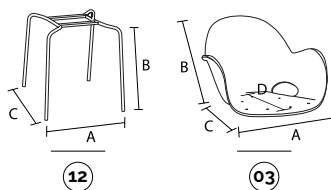

optionals

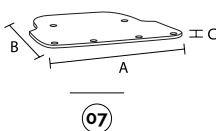

12 telaio 4 gambe d.16 senza tappi 4 legs frames d.16 without caps

code	finishing	q.kit	q.pack	a	b	c	kg.x1	vol.x1
110603-613	● nero/black	x1	200	415	445	520	2.05	mc. 0.014
110605-613	● avorio/ivory ral1013	x1	200	415	445	520	2.05	mc. 0.014
110604-613	● grigio/grey	x1	200	415	445	520	2.05	mc. 0.014
110610-613	● cromato/chrome	x1	200	415	445	520	2.05	mc. 0.014
110603-614	● nero/black *per esterno/outdoor	x1	200	415	445	520	2.05	mc. 0.014
110605-614	● avorio/ivory ral1013 *per esterno/outdoor	x1	200	415	445	520	2.05	mc. 0.014
110604-614	● grigio/grey *per esterno/outdoor	x1	200	415	445	520	2.05	mc. 0.014

13 puntale alettato tondo d.16 nero inner cap for legs d.16 black

code	finishing	q.kit
134203-160	● nero/black	x4

03 scocca a pozzetto con braccioli (anti-uv) plastic shell with arms (anti-uv)

code	finishing	q.kit	q.pack	a	b	c	d	kg.x1	vol.x1
133905-042	● avorio/ivory ral1013	x1	5	570	430	590	410	2.9	mc. 0.041

04 copertina in plastica (anti-uv) plastic cover (anti-uv)

code	finishing	q.kit	q.pack	a	b	c	kg.x1
132205-039	● avorio/ivory ral1013	x1	25	265	250	40	0.15

05 vite tsp+ m6x25 zincata bianca (vite per fissaggio scocca con copertina) x 4g sl cv pc gir screw tsp+ m6x25 white zinc (screw for fix shell with cover)

code	finishing	q.kit
117711-199	● zincata bianca/white zinc	x4

07 pannello sedile multistrato plywood seat panel

code	finishing	q.kit	q.pack	a	b	c	kg.x1	vol.x1
122207-023	● faggio/plywood	x1	20	376	370	5	0.3	mc. 0.0019

08 vite tbcl m4x12 zincata bianca (vite per fissaggio pannello sedile) screw tbcl m4x12 white zinc (screw for fix seat panel)

code	finishing	q.kit
117711-126	● zincata bianca/white zinc	x6



for all colour codes, see page 151

wing

wooden 4-legs



plastic colours

- avorio/ivory ral1013
- corallo/coral 1797u
- nocciola/hazelnut 2312u
- nero/black ral9005
- blu/blue 541u

14 03 15 07 08
optional

main component sizes

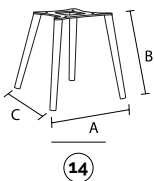

14 kit 4 gambe legno massello faggio trasparente + piastra in metallo
kit beechwood 4 legs frames with metal plate

code	finishing	plate colour	q.kit	a	b	c
120107-000	● faggio/beechwood	nero/black	x1	420	440	490
120107-001	● faggio/beechwood	bianco/white	x1	420	440	490

15 vite tbl combi m6x16 dentell, zinc. bianca (vite per fissaggio scocca senza copertina) legno
screw tbl combi m6x16 white zinc (screw for fix shell without cover) wooden 4-legs

code	finishing	q.kit
117711-191	● zincata bianca/white zinc	x4

for the components below, see previous page

03 07 08



for all colour codes, see page 151

wing

swivel



plastic colours

- avorio/ivory ral1013
- corallo/coral 1797u
- nocciola/hazelnut 2312u
- nero/black ral9005
- blu/blue 541u

main component sizes

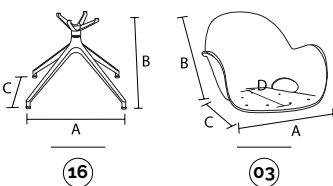

optionals

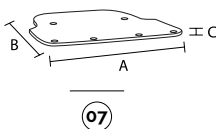

16 03 06 07 08
optional

16 base 4 razze d720 in alluminio
high aluminium base d.720

code	finishing	q.kit	q.pack	a	b	c	kg.x1
110210-090	● alluminio/aluminium	x1	6	515	415	515	4.03

03 scocca a pozzetto con braccioli (anti-uv)
plastic shell with arms (anti-uv)

code	finishing	q.kit	q.pack	a	b	c	d	kg.x1	vol.x1
133903-040	● nero/black ral9005	x1	5	570	430	590	410	2.9	mc. 0.041

06 vite t6l combi m6x12 dentell. zincata bianca (vite per fissaggio scocca senza copertina) 4g sl cv pc gir
screw t6l combi m6x12 white zinc (screw for fix shell without cover)

code	finishing	q.kit
117711-206	● zincata bianca/white zinc	x4

07 pannello sedile multistrato
plywood seat panel

code	finishing	q.kit	q.pack	a	b	c	kg.x1	vol.x1
122207-023	● faggio/plywood	x1	20	376	370	5	0.3	mc. 0.0019

08 vite t6cl m4x12 zincata bianca (vite per fissaggio pannello sedile)
screw t6cl m4x12 white zinc (screw for fix seat panel)

code	finishing	q.kit
117711-126	● zincata bianca/white zinc	x6



for all colour codes, see page 151

wing

swivel



plastic colours

- avorio/ivory ral1013
- corallo/coral 1797u
- nocciola/hazelnut 2312u
- nero/black ral9005
- blu/blue 541u

main component sizes

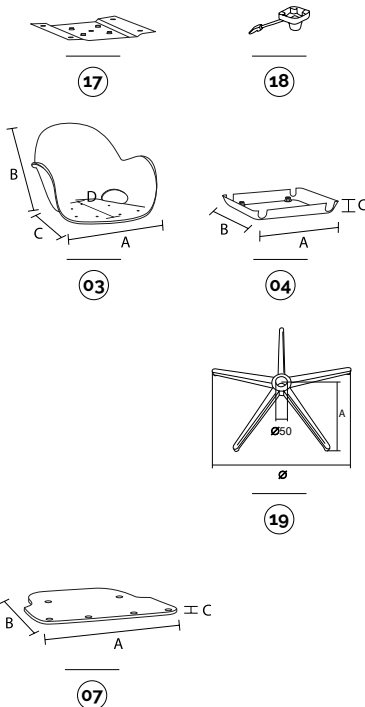

optionals

17 03 18 04 05 07 08 19
optional

17 g2p(01) gnr - piastra per girevole nera
g2p(01) gnr - plate for swivel black

code	finishing	q.kit	q.pack	kg.x1	vol.x1
110903-000	● nero/black	x1	25	0,85	mc. 0.0008

18 blocchetto in alluminio 0' d.28 x gas con leva nero opaco
black alu block 0' d.28 x gas with lever

code	finishing	q.kit	q.pack	kg.x1	vol.x1
110903-100	● nero/black	x1	1	0,305	mc. 0.0225

03 scocca a pozzetto con braccioli (anti-uv)
plastic shell with arms (anti-uv)

code	finishing	q.kit	q.pack	a	b	c	d	kg.x1	vol.x1
133915-042	● blu/blue 541u	x1	5	570	430	590	410	2,9	mc. 0.041

04 copertina in plastica (anti-uv)
plastic cover (anti-uv)

code	finishing	q.kit	q.pack	a	b	c	kg.x1
132215-039	● blu/blue 541u	x1	25	265	250	40	0,15

05 vite tsp+ m6x25 zincata bianca (vite per fissaggio scocca con copertina) x 4g sl cv pc gir
screw tsp+ m6x25 white zinc (screw for fix shell with cover)

code	finishing	q.kit
117711-199	● zincata bianca/white zinc	x4

07 pannello sedile multistrato con 6 borchie m4
seat panel with 6 upholstery nail m4

code	finishing	q.kit	q.pack	a	b	c	kg.x1	vol.x1
122207-023	● faggio/plywood	x1	20	376	370	5	0,3	mc. 0.0019

08 vite tbcl m4x12 zincata bianca (vite per fissaggio pannello sedile)
screw tbcl m4x12 white zinc (screw for fix seat panel)

code	finishing	q.kit
117711-126	● zincata bianca/white zinc	x6

19 base in metallo d.640 con coprisaldatura
metal base d.640 with cover welding

code	finishing	q.kit	q.pack	ø	a	kg.x1	vol.x1
110210-057	● cromato/chrome	x1	5	640	112	2,25	mc. 0.0117



for all colour codes, see page 151

wing

bench

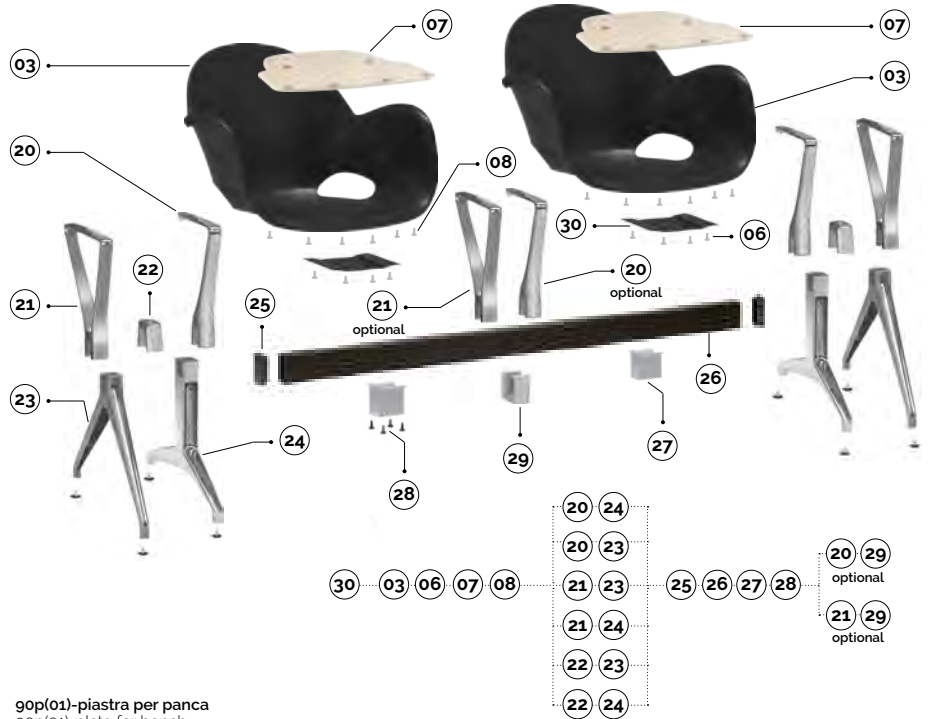

plastic colours

- avorio/ivory ral1013
- corallo/coral 1797u
- nocciola/hazelnut 2312u
- nero/black ral9005
- blu/blue 541u



30

main component sizes



20

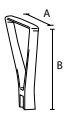

21

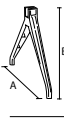

22

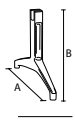

23

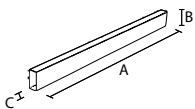

24



25



26



27

03 06 07 08

for the components below, see previous pages

for the bench components, see page 417

30 90p(01)-piastra per panca 90p(01)-plate for bench

code	finishing	q.kit	q.pack	kg.x1	vol.x1
110703-013	● nero/black	x1	25	0,85	mc. 0,0008
110704-078	● grigio/grey	x1	25	0,85	mc. 0,0008

20 cut-bracciolo in alluminio per panca + n'2 viti cut-aluminium arm for bench + n'2 screw

code	finishing	q.kit	q.pack	a	b	kg.x1	vol.x1
111704-223	● alluminio/aluminium	x1	10	300	305	1,40	mc. 0,0011

21 slim-bracciolo in alluminio per panca + n'2 viti slim-aluminium arm for bench + n'2 screw

code	finishing	q.kit	q.pack	a	b	kg.x1	vol.x1
111704-225	● alluminio/aluminium	x1	10	325	305	1,40	mc. 0,0011

22 cut/slim-cavallotto in alluminio per gamba panca + n'2 viti cut/slim-aluminium bracket 80x40 for bench leg + n'2 screw

code	finishing	q.kit	q.pack	kg.x1	vol.x1
111704-222	● alluminio/aluminium	x1	10	0,40	mc. 0,0012

23 slim-gamba in alluminio per panca slim-aluminium leg for bench

code	finishing	q.kit	q.pack	a	b	kg.x1	vol.x1
111704-226	● alluminio/aluminium	x2	5	610	350	1,20	mc. 0,014

24 cut-gamba in alluminio per panca cut-aluminium leg for bench

code	finishing	q.kit	q.pack	a	b	kg.x1	vol.x1
111704-224	● alluminio/aluminium	x2	5	610	350	2,55	mc. 0,014

25 tappo copritesta rettangolare 80x40 nero rectangular cover head cap 80x40 black

code	finishing	q.kit
134103-001	● nero/black	x2

26 got(03) trave per panca 80x40 got(03) beam for bench 80x40

code	finishing	q.kit	q.pack	a	b	c	kg.x1	vol.x1	
110703-190	● nero/black	2 posti / 2 seats	x1	1	1160	80	40	3,20	mc. 0,0045
110704-190	● grigio/grey	2 posti / 2 seats	x1	1	1160	80	40	3,20	mc. 0,0045
110703-191	● nero/black	3 posti / 3 seats	x1	1	1710	80	40	4,71	mc. 0,005
110704-191	● grigio/grey	3 posti / 3 seats	x1	1	1710	80	40	4,71	mc. 0,005
110703-192	● nero/black	4 posti / 4 seats	x1	1	2260	80	40	6,22	mc. 0,0085
110704-192	● grigio/grey	4 posti / 4 seats	x1	1	2260	80	40	6,22	mc. 0,0085
110703-193	● nero/black	5 posti / 5 seats	x1	1	2800	80	40	7,72	mc. 0,01
110704-197	● grigio/grey	5 posti / 5 seats	x1	1	2800	80	40	7,72	mc. 0,01

27 gocv-cavallotto sotto trave gocv-support under beam

code	finishing	q.kit	q.pack	a	b	kg.x1	vol.x1
110703-007	● nero/black	x1	50	55	65	0,60	mc. 0,0005
110704-016	● grigio/grey	x1	50	55	65	0,60	mc. 0,0005

28 confezione viti m8x12 testa cilindrica a esagono incassato brunita nera screws m8x12 cylindrical head hexagon embedded burnishing black package

code	finishing	q.kit	q.pack
117003-070	● nero/black	x4	200

29 cut/slim-cavallotto in alluminio per bracciolo panca cut/slim-aluminium bracket 80x40 for bench arm

code	finishing	q.kit	q.pack	kg.x1	vol.x1
111704-221	● alluminio/aluminium	x1	10	0,32	mc. 0,0012

OPTIONAL
bench connector



E-USB
bench plug



JIM
bench leg



plastic

90GM
bench leg



90GF
bench leg



91GM **NEW**
bench leg



100GM
bench leg



200GM
bench leg



PIONEER
bench arm



CUT
bench leg



SLIM
bench leg



CUT
bench arm



SLIM
bench arm



metal

aluminium

wing

optional colour codes



plastic colour codes



03

scocca a pozzetto con braccioli (anti-uv)
plastic shell with arms (anti-uv)

- 133905-042 avorio/ivory ral1013
- 133902-042 corallo/coral 1797u
- 133907-042 nocciola/hazelnut 2312u
- 133903-040 nero/black ral9005
- 133915-042 blu/blue 541u



04

copertina in plastica (anti-uv)
plastic cover (anti-uv)

- 132205-039 avorio/ivory ral1013
- 132202-039 corallo/coral 1797u
- 132207-039 nocciola/hazelnut 2312u
- 132203-039 nero/black ral9005
- 132215-039 blu/blue 541u





feel



discover more about
Feel Collection

La seduta versatile e dal design distintivo. Confortevole e dallo stile grintoso, grazie al doppio design frontale/posteriore sullo schienale. Prevede 5 telai tra cui scegliere e numerosi accessori. Disponibili inoltre i telai per braccioli e i telai per tavoletta, al fine di arredare anche ambienti dedicati alla formazione.

Feel è ideale per ambienti Contract e Home, anche in outdoor grazie alla specifica verniciatura dei telai.

The versatile chair with a distinctive design. Comfortable and with rugged styling, thanks to the dual-faced design on the backrest. 5 frames to choose from and numerous accessories. Frame also available with versions featuring armrests and writing tablets, making it ideal also for training environments.

Feel is ideal for Contract and Home environments, even outdoors thanks to the special paint used on the frames.

Plus

- 8 colori di tendenza per la scocca.
- Impilabile sia con telaio slitta sia 4 gambe.
- Disponibile con pannellino in plastica da tappezzare e pratici agganci laterali.
- Certificazione EN 16139:2013+AC2013 Livello 1.
- Certificazione ANSI/BIFMA X5.1.
- 8 trendy colours for the seat shell.
- Stackable in both the sled and 4-legged versions.
- Available with plastic seat pad to be upholstered and practical lateral hooks.
- EN 16139:2013+AC2013 Level 1 Certification.
- ANSI/BIFMA X5.1 Certification.



designed by:
Stefano Bettio



**outdoor
ready**



**trolley
available**



**certified
product**

feel

slide



CERTIFIED BY
BIFMA

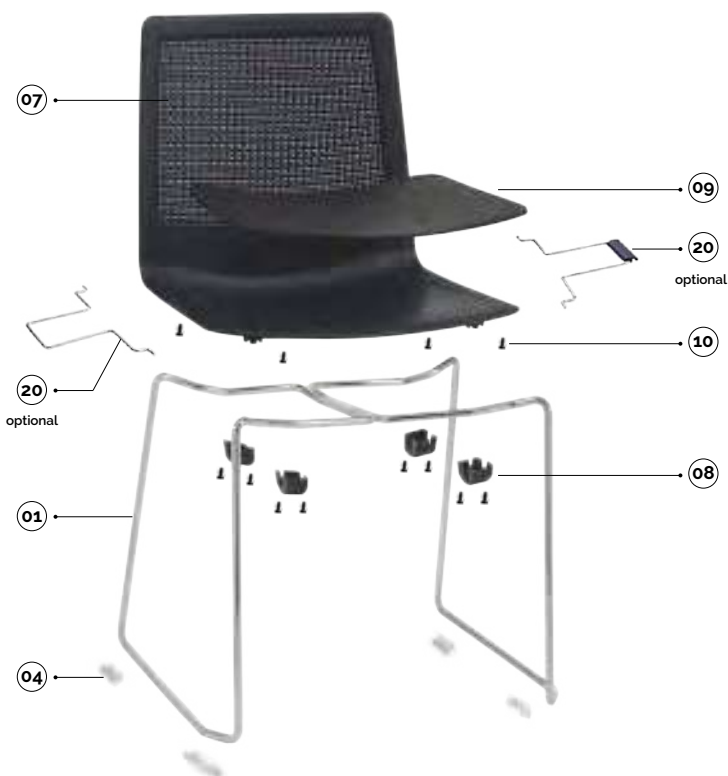

- blu/blue ral5014
- arancio/orange ral2003
- nero/black ral9005
- verde/green pantone 7495el
- bianco/white 218
- grigio/grey ral7003
- sabbia/sand ral1019
- rosso/red ral527
- bianco autoestinguente/
fire retardant white 218

plastic colours

main component sizes

optionals

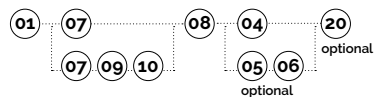
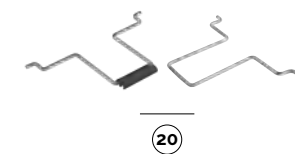
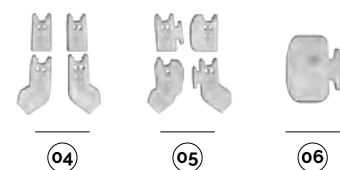
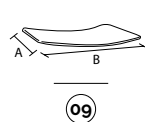
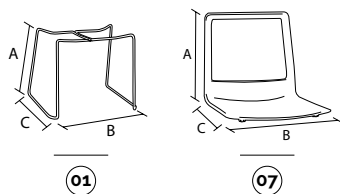

01 feel-telaio a slitta in tondino d.12
feel-slide wire frame d.12

code	finishing	q.kit	q.pack	a	b	c	kg.x1	vol.x1
113410-057	● cromato/chrome	x1	100	460	530	470	3,75	mc. 0.03

04 btf-kit piedini
btf-kit feet

code	finishing	q.kit	q.pack	kg.x1
134306-001	○ neutro/neutral	x1	100	0,05

05 btfa-kit piedini con ganci
btfa-kit feet with hooks

code	finishing	q.kit	q.pack	kg.x1
134306-002	○ neutro/neutral	x1	100	0,06

06 pptf-tappo per fissaggio pavimento
pptf-cap for fixing to the floor

code	finishing	q.kit	q.pack	kg.x1
134306-003	○ neutro/neutral	x2	100	0,03

07 feel-scocca intera modello feel
feel-plastic shell model feel

code	finishing	q.kit	q.pack	a	b	c	kg.x1	vol.x1
133903-060	● nero/black ral9005	x1	10	420	450	430	1,70	mc. 0.02

08 feel-confezione accessori per scocca feel per tondino
feel-accessory pack for wire frame feel

code	finishing	q.kit	q.pack	kg.x1	vol.x1
137003-061	● nero/black ral9005	x1	10	wire frame	0,07 mc. 0.001

09 feel-pannello sedile da tappezzare
feel-panel back for upholstery

code	finishing	q.kit	q.pack	a	b	kg.x1	vol.x1
132203-059	● nero/black	x1	25	400	440	0,6	mc. 0.003

10 vite hilo tb+ 5x14 zincata nera (per fissare pannello sedile)
screw hilo tb+ 5x14 for upholstery seat panel

code	finishing	q.kit
117803-155	● nero/black	x8

20 feel-coppia agganci laterale in tondino + plastica
feel-pair side wire hooks + plastic

code	finishing	q.kit	kg.x1	vol.x1
113410-056	● cromato/chrome	x1	0,15	mc. 0.002



for all colour codes, see page 163

feel

slide w/armrests



- blu/blue ral5014
- arancio/orange ral2003
- nero/black ral9005
- verde/green pantone 7495el
- bianco/white 218
- grigio/grey ral7003
- sabbia/sand ral1019
- rosso/red ral527
- bianco autoestinguente/ fire retardant white 218

plastic colours

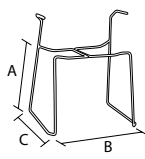
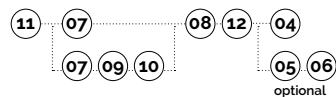
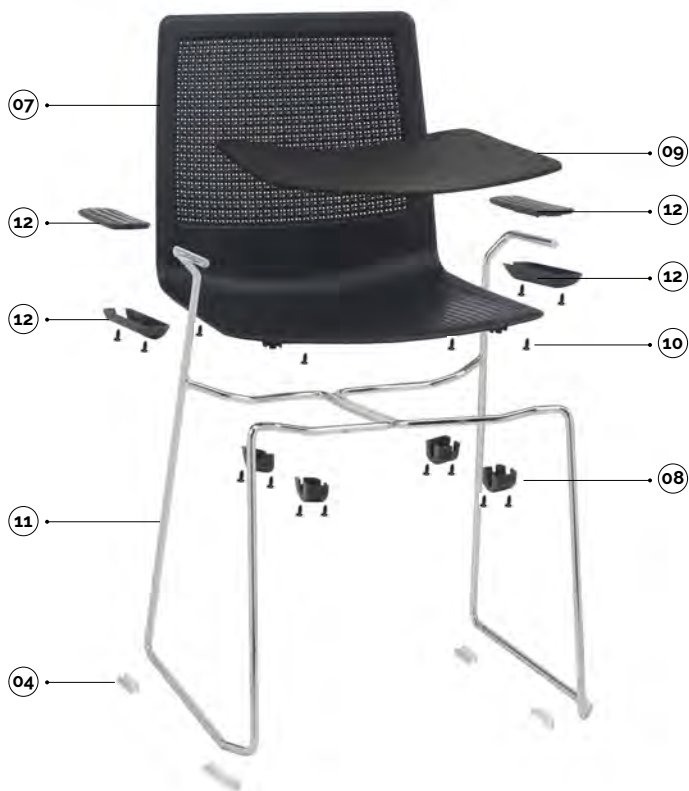

11



12

main component sizes

11 feel-telaio a slitta in tondino d.12 con braccioli
feel-slide wire frame d.12 with arms

code	finishing	q.kit	q.pack	a	b	c	kg.x1	vol.x1
113410-058	● cromato/chrome	x1	60	460	530	470	4,50	mc. 0.035

12 feel-coppia braccioli in plastica colorata + viti
feel-pair colored plastic arm + screws

code	finishing	q.kit	q.pack	a	b	kg.x1	vol.x1
131703-062	● nero/black ral9005	x1	20	right + left	200 30	0,16	mc. 0.001

for the components below, see previous page

- 04 05 06 07 08 09 10



for all colour codes, see page 163



feel-carrello portasedie con accessori nero
feel-trolley for chairs with accessories black

code	finishing	q.kit
110803-329	● nero/black	x1

feel

slide w/writing tablet



- plastic colours
- blu/blue ral5014
 - arancio/orange ral2003
 - nero/black ral9005
 - verde/green pantone 7495el
 - bianco/white 218
 - grigio/grey ral7003
 - sabbia/sand ral1019
 - rosso/red ral527
 - bianco autoestinguente/ fire retardant white 218

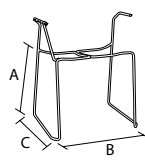
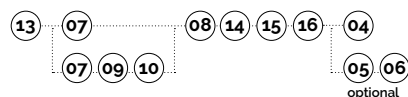

13



14



15

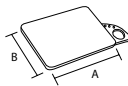

16

13 feel-telaio a slitta in tondino d.12 con braccioli e portatavoletta
feel-slide wire frame d.12 with arms and writing tablet hook

code	finishing	q.kit	q.pack	a	b	c	kg.x1	vol.x1
113410-072	● cromato/chrome right writing tablet hook	x1	30	460	530	470	5,00	mc. 0,07
113410-073	● cromato/chrome left writing tablet hook	x1	30	460	530	470	5,00	mc. 0,07

14 feel-coppia braccioli in plastica colorata per tavoletta + viti
feel-pair colored plastic arm for tablet + screws

code	finishing	q.kit	q.pack	a	b	kg.x1	vol.x1
131703-063	● nero/black ral9005	x1	20	right-left for tablet	200	30	0,16 mc. 0,0045
131703-064	● nero/black ral9005	x1	20	left-right for tablet	200	30	0,16 mc. 0,0045

15 spt2-snodo per tavoletta in termoplastica
spt2-thermoplastic writing tablet articulation

code	finishing	q.kit	q.pack	a	b	c	kg.x1	vol.x1
134003-039	● nero/black	x1	20	180	66	15x15	0,35	mc. 0,0006

16 tlt3-tavoletta ambidestro con portabicchiere e portapenne
tlt3-writing tablet with cup holder and pen tray

code	finishing	q.kit	q.pack	a	b	kg.x1	vol.x1
134003-041	● nero/black	x1	10	410	300		1,05 mc. 0,036

for the components below, see previous pages

04 05 06 07 08 09 10



for all colour codes, see page 163

TLT
tablet



TLT2
tablet

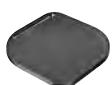

TLT3
tablet



BEAN
tablet



TL02
tablet



SPT2
mechanism tablet



SPTA
mechanism antipanic



for writing tablet options, see page 404/405

feel

stool

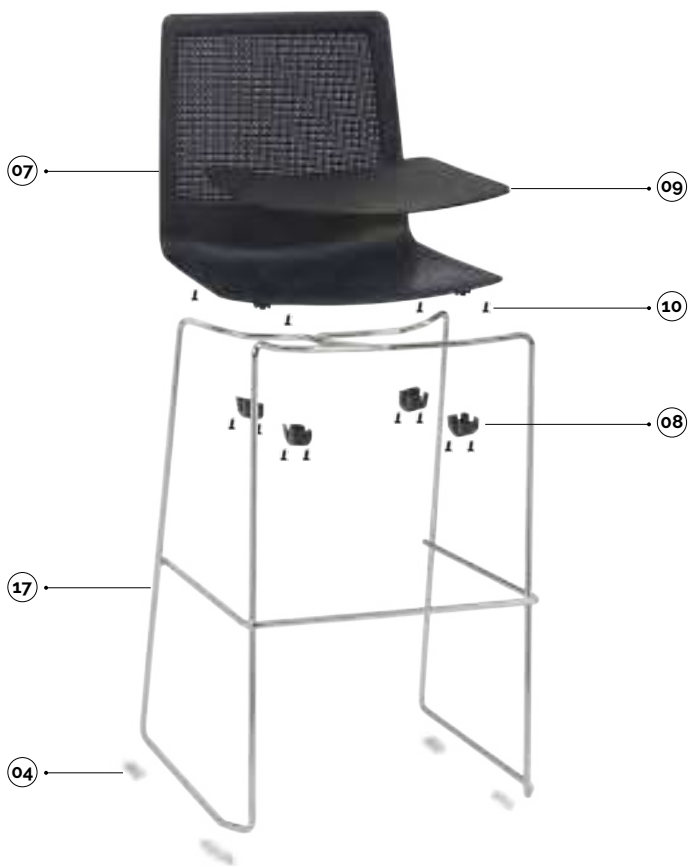

plastic colours

- blu/blue ral5014
- arancio/orange ral2003
- nero/black ral9005
- verde/green pantone 7495el
- bianco/white 218
- grigio/grey ral7003
- sabbia/sand ral1019
- rosso/red ral527
- bianco autoestinguente/ fire retardant white 218

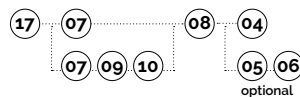

main component sizes

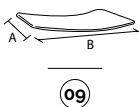
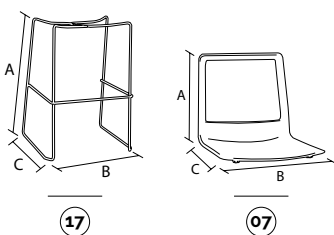

optionals

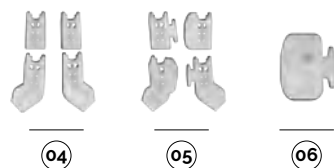

17 feel-sgabello alto h730 in tondino d.12 per scocca senza tappi feel-wire d.12 high bar stool H730 for shell feel without caps

code	finishing	q.kit	q.pack	a	b	c	kg.x1	vol.x1
113410-059	● cromato/chrome	x1	50	730	530	500	6,20	mc. 0,08

04 btf-kit piedini btf-kit feet

code	finishing	q.kit	q.pack	kg.x1
134306-001	○ neutro/neutral	x1	100	0,05

05 btfa-kit piedini con ganci btfa-kit feet with hooks

code	finishing	q.kit	q.pack	kg.x1
134306-002	○ neutro/neutral	x1	100	0,06

06 pptf-tappo per fissaggio pavimento pptf-cap for fixing to the floor

code	finishing	q.kit	q.pack	kg.x1
134306-003	○ neutro/neutral	x2	100	0,03

07 feel-scocca intera modello feel feel-plastic shell model feel

code	finishing	q.kit	q.pack	a	b	c	kg.x1	vol.x1
133903-060	● nero/black ral9005	x1	10	420	450	430	1,70	mc. 0,02

08 feel-confezione accessori per scocca feel per tondino feel-accessory pack for wire frame feel

code	finishing	q.kit	q.pack	kg.x1	vol.x1
137003-061	● nero/black ral9005	x1	10	telaio in tondino/wire frame	0,07 mc. 0,001

09 feel-pannello sedile da tappezzare feel-panel back for upholstery

code	finishing	q.kit	q.pack	a	b	kg.x1	vol.x1
132203-059	● nero/black	x1	25	400	440	0,6	mc. 0,003

10 vite hilo tb+ 5x14 zincata nera (per fissare pannello sedile) screw hilo tb+ 5x14 for upholstery seat panel

code	finishing	q.kit
117803-155	● nero/black	x8



for all colour codes, see page 163

feel

4-legs



CERTIFIED BY
CATAS

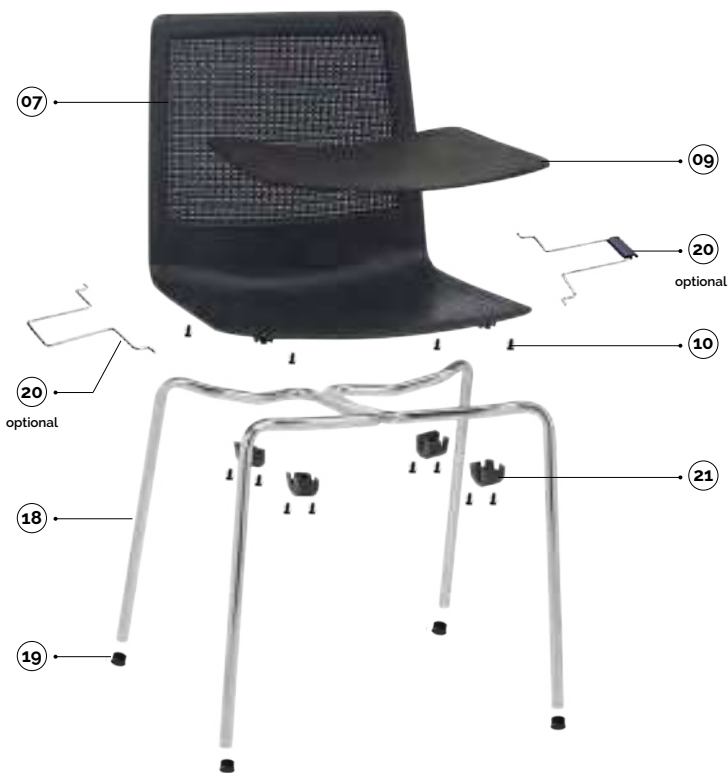

plastic colours

- blu/blue ral5014
- arancio/orange ral2003
- nero/black ral9005
- verde/green pantone 7495el
- bianco/white 218
- grigio/grey ral7003
- sabbia/sand ral1019
- rosso/red ral527
- bianco autoestinguente/
fire retardant white 218

main component sizes

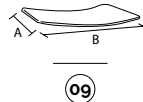
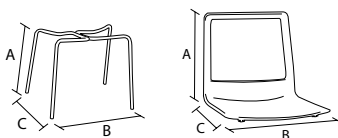

optionals

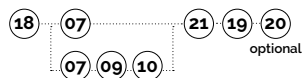
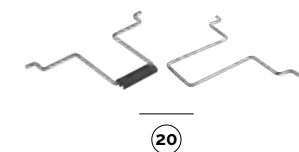

18 feel-telaio 4 gambe in tubo d.18 senza tappi feel-4 legs frames d.18 without caps

code	finishing	q.kit	q.pack	a	b	c	kg.x1	vol.x1
112703-031	● nero/black ral9005	x1	200	440	510	500	2	mc. 0.025
112704-031	● grigio/grey ral7003	x1	200	440	510	500	2	mc. 0.025
112705-031	○ bianco/white ral9003	x1	200	440	510	500	2	mc. 0.025
112710-031	● cromato/chrome	x1	200	440	510	500	2	mc. 0.025
112703-032'	● nero/black ral9005 'per esterno/outdoor	x1	200	440	510	500	2	mc. 0.025
112704-032'	● grigio/grey ral7003 'per esterno/outdoor	x1	200	440	510	500	2	mc. 0.025
112705-032'	○ bianco/white ral9003 'per esterno/outdoor	x1	200	440	510	500	2	mc. 0.025

19 confezione puntali tondi d.18 neri black inner round caps d.18 package

code	finishing	q.kit	q.pack
137003-072	● nero/black	x1	200
134205-181	○ bianco/white	x1	

07 feel-scocca intera modello feel feel-plastic shell model feel

code	finishing	q.kit	q.pack	a	b	c	kg.x1	vol.x1
133903-060	● nero/black ral9005	x1	10	420	450	430	1,70	mc. 0.02

21 feel-confezione accessori per scocca feel per tubo d.18 feel-accessory pack for shell feel for tube d.18

code	finishing	q.kit	q.pack	kg.x1	vol.x1
137003-060	● nero/black ral9005	x1	10	telaio tubo/tube frame	0,07 mc. 0.001

09 feel-pannello sedile da tappezzare feel-panel back for upholstery

code	finishing	q.kit	q.pack	a	b	kg.x1	vol.x1
132203-059	● nero/black	x1	25	400	440	0,6	mc. 0.003

10 vite hilo tb+ 5x14 zincata nera (per fissare pannello sedile) screw hilo tb+ 5x14 for upholstery seat panel

code	finishing	q.kit
117803-155	● nero/black	x8

20 feel-coppia agganci laterale in tondino + plastica feel-pair side wire hooks + plastic

code	finishing	q.kit	kg.x1	vol.x1
113410-056	● cromato/chrome	x1	0,15	mc. 0.002



for all colour codes, see page 163

feel

4-legs w/armrests



- blu/blue ral5014
- arancio/orange ral2003
- nero/black ral9005
- verde/green pantone 7495el
- bianco/white 218
- grigio/grey ral7003
- sabbia/sand ral1019
- rosso/red ral527
- bianco autoestinguente/ fire retardant white 218

plastic colours

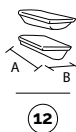
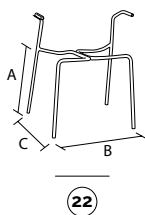
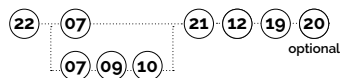

main component sizes

22 feel-telaio 4 gambe d.18 con braccioli senza tappi
feel-4 legs frame d.18 with arm and without caps

code	finishing		q.kit	q.pack	a	b	c	kg.x1	vol.x1
112703-033	● nero/black	ral9005	x1	60	440	510	500	2,6	mc. 0.035
112704-033	● grigio/grey	ral7003	x1	60	440	510	500	2,6	mc. 0.035
112705-033	○ bianco/white	ral9003	x1	60	440	510	500	2,6	mc. 0.035
112710-033	● cromato/chrome		x1	60	440	510	500	2,6	mc. 0.035
112703-034'	● nero/black	ral9005 'per esterno/outdoor	x1	60	440	510	500	2,6	mc. 0.035
112704-034'	● grigio/grey	ral7003 'per esterno/outdoor	x1	60	440	510	500	2,6	mc. 0.035
112705-034'	○ bianco/white	ral9003 'per esterno/outdoor	x1	60	440	510	500	2,6	mc. 0.035

12 feel-coppia braccioli in plastica colorata + viti
feel-pair colored plastic arm + screws

code	finishing		q.kit	q.pack	a	b	kg.x1	vol.x1
131703-062	● nero/black	ral9005	x1	20	right + left	200 30	0,16	mc. 0.001

for the components below, see previous pages

- 19 07 21 09 10 20



for all colour codes, see page 163

optionals

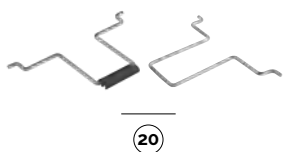

feel

4-legs w/writing tablet



- blu/blue ral5014
- arancio/orange ral2003
- nero/black ral9005
- verde/green pantone 7495el
- bianco/white 218
- grigio/grey ral7003
- sabbia/sand ral1019
- rosso/red ral527
- bianco autoestinguente/ fire retardant white 218

plastic colours

main component sizes

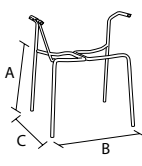

23



14



15

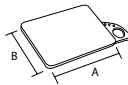

16

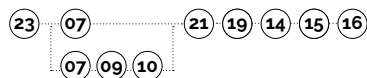

23 feel-telaio 4 gambe in tubo d.18 senza tappi con braccioli e portatavoletta
feel-4 legs frames d.18 without caps with armrests and writing tablet hook

code	finishing		q.kit	q.pack	a	b	c	kg.x1	vol.x1
112703-037	● nero/black	ral9005 - right writ. tab. hook	x1	30	440	510	500	3,50	mc. 0.07
112704-037	● grigio/grey	ral7003 - right writ. tab. hook	x1	30	440	510	500	3,50	mc. 0.07
112705-037	○ bianco/white	ral9003 - right writ. tab. hook	x1	30	440	510	500	3,50	mc. 0.07
112710-037	● cromato/chrome	right writing tablet hook	x1	30	440	510	500	3,50	mc. 0.07
112703-038	● nero/black	ral9005 - left writ. tab. hook	x1	30	440	510	500	3,50	mc. 0.07
112704-038	● grigio/grey	ral7003 - left writ. tab. hook	x1	30	440	510	500	3,50	mc. 0.07
112705-038	○ bianco/white	ral9003 - left writ. tab. hook	x1	30	440	510	500	3,50	mc. 0.07
112710-038	● cromato/chrome	left writing tablet hook	x1	30	440	510	500	3,50	mc. 0.07

14 feel-coppia braccioli in plastica colorata per tavoletta + viti
feel-pair colored plastic arm for tablet + screws

code	finishing		q.kit	q.pack	a	b	kg.x1	vol.x1
131703-063	● nero/black	ral9005	x1	20	right+left for tablet	200 30	0,16	mc. 0.0045
131703-064	● nero/black	ral9005	x1	20	left+right for tablet	200 30	0,16	mc. 0.0045

15 sp2z-snodo per tavoletta in termoplastica
sp2z-thermoplastic writing tablet articulation

code	finishing		q.kit	q.pack	a	b	c	kg.x1	vol.x1
134003-039	● nero/black		x1	20	180	66	15x15	0,35	mc. 0.0006

16 tl3-tavoletta ambidestro con portabicchiere e portapenne
tl3-writing tablet with cup holder and pen tray

code	finishing		q.kit	q.pack	a	b	kg.x1	vol.x1	
134003-041	● nero/black		x1	10	410	300		1,05	mc. 0.036

for the components below, see previous pages



for all colour codes, see page 163

19 07 09 10 21 20



for writing tablet options, see page 404/405

feel

swivel



- blu/blue ral5014
- arancio/orange ral2003
- nero/black ral9005
- verde/green pantone 7495el
- bianco/white 218
- grigio/grey ral7003
- sabbia/sand ral1019
- rosso/red ral527
- bianco autoestinguente/
fire retardant white 218

plastic colours

main component sizes

optionals

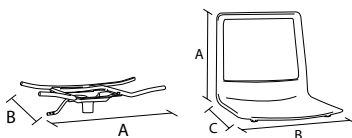

24

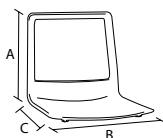

07

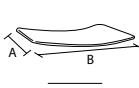

09



26

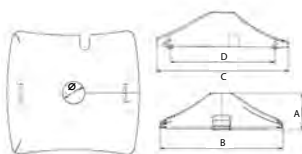

25

24 feel-supporto girevole a gas per scocca feel

feel-swivel frame for feel shell

code	finishing	q.kit	q.pack	a	b	kg.x1	vol.x1
110903-033	● nero/black ral9005	x1	10	400	320	2,20	mc. 0,004
110904-033	● grigio/grey ral7003	x1	10	400	320	2,20	mc. 0,004

07 feel-scocca intera modello feel

feel-plastic shell model feel

code	finishing	q.kit	q.pack	a	b	c	kg.x1	vol.x1
133903-060	● nero/black ral9005	x1	10	420	450	430	1,70	mc. 0,02

08 feel-confezione accessori per scocca feel per tondino

feel-accessory pack for wire frame feel

code	finishing	q.kit	q.pack	kg.x1	vol.x1
137003-061	● nero/black ral9005	x1	10	wire frame	0,07 mc. 0,001

09 feel-pannello sedile da tappezzare

feel-panel base for upholstery

code	finishing	q.kit	q.pack	a	b	kg.x1	vol.x1
132203-059	● nero/black	x1	25	400	440	0,6	mc. 0,003

10 vite hilo tb+ 5x14 zincata nera (per fissare pannello sedile)

screw hilo tb+ 5x14 for upholstery seat panel

code	finishing	q.kit
117803-155	● nero/black	x8

25 cpg-copertina in plastica per telaio girevole

cpg-plastic cover for swivel frame

code	finishing	q.kit	q.pack	a	b	c	d	ø	kg.x1	vol.x1
130903-000	● nero/black	x1	50	60	200	210	167	36	0,1	mc. 0,0015

26 b40-base in metallo d.640 con coprisaldatura

b40-metal base d.640 with cover welding

code	finishing	q.kit	q.pack	a	ø	kg.x1	vol.x1
110210-027	● cromato/chrome	x1	5	60	640	2,85	mc. 0,014

CPG
plastic cover for swivel frame

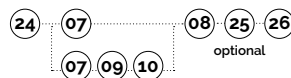

for all colour codes, see page 163

feel

bench



plastic colours

- blu/blue ral5014
- arancio/orange ral2003
- nero/black ral9005
- verde/green pantone 7495el
- bianco/white 218
- grigio/grey ral7003
- sabbia/sand ral1019
- rosso/red ral527
- bianco autoestinguente/ fire retardant white 218

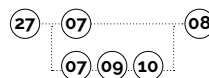

main component sizes

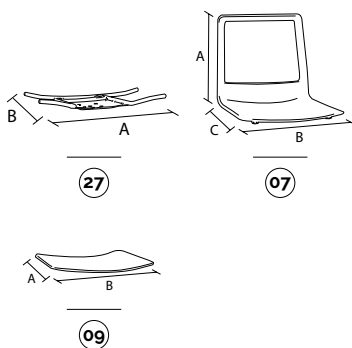

27 feel-supporto per attacco scocca feel su panca feel-bench frame for feel shell

code	finishing	q.kit	q.pack	a	b	kg.x1	vol.x1
110703-029	● nero/black	x1	10	400	320	2,10	mc. 0,004

07 feel-scocca intera modello feel feel-plastic shell model feel

code	finishing	q.kit	q.pack	a	b	c	kg.x1	vol.x1
133903-060	● nero/black ral9005	x1	10	420	450	430	1,70	mc. 0,02

08 feel-confezione accessori per scocca feel per tondino feel-accessory pack for wire frame feel

code	finishing	q.kit	q.pack	kg.x1	vol.x1
137003-061	● nero/black ral9005	x1	10	wire frame	0,07 mc. 0,001

09 feel-pannello sedile da tappezzare feel-panel back for upholstery

code	finishing	q.kit	q.pack	a	b	kg.x1	vol.x1
132203-059	● nero/black	x1	25	400	440	0,6	mc. 0,003

10 vite hilo tb+ 5x14 zincata nera (per fissare pannello sedile) screw hilo tb+ 5x14 for upholstery seat panel

code	finishing	q.kit
117803-155	● nero/black	x8

for the bench components, see page 417



for all colour codes, see page 163

optionals

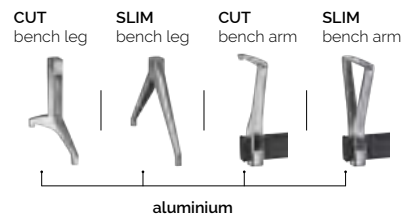
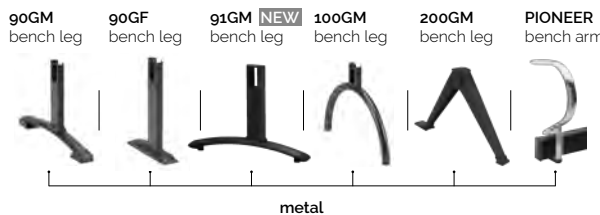
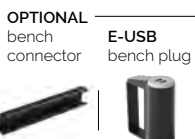

feel

optional colour codes

shell colour codes



07 scocche in plastica plastic shells

●	133915-060	blu/blue ral5014
●	133907-060	arancio/orange ral2003
●	133903-060	nero/black ral9005
●	133916-060	verde/green pantone 7495el
○	133905-060	bianco/white 218
●	133904-060	grigio/grey ral7003
●	133907-059	sabbia/sand ral1019
●	133902-060	rosso/red ral527



accessory and armrest colour codes



08 accessori in plastica per telai slitta/girevole/panca plastic accessories for wire/swivel/bench frames

●	137015-061	blu/blue ral5014
●	137007-061	arancio/orange ral2003
●	137003-061	nero/black ral9005
●	137016-061	verde/green pantone 7495el
○	137005-061	bianco/white 218
●	137004-061	grigio/grey ral7003
●	137007-058	sabbia/sand ral1019
●	137002-061	rosso/red ral527



21 accessori in plastica per telaio 4-gambe plastic accessories for 4-legs frame

●	137015-060	blu/blue ral5014
●	137007-060	arancio/orange ral2003
●	137003-060	nero/black ral9005
●	137016-060	verde/green pantone 7495el
○	137005-060	bianco/white 218
●	137004-060	grigio/grey ral7003
●	137007-059	sabbia/sand ral1019
●	137002-060	rosso/red ral527



12 braccioli in plastica per telai 4-gambe e filo plastic armrests for 4-legs and wire frames

●	131715-062	blu/blue ral5014
●	131707-062	arancio/orange ral2003
●	131703-062	nero/black ral9005
●	131716-062	verde/green pantone 7495el
○	131705-062	bianco/white 218
●	131704-062	grigio/grey ral7003
●	131707-059	sabbia/sand ral1019
●	131702-062	rosso/red ral527



14 braccioli in plastica per tavoletta per telai 4-gambe e filo plastic armrests for tablet for 4-legs and wire frames

●	131715-063	right + left for tablet	blu/blue ral5014
●	131715-064	left + right for tablet	blu/blue ral5014
●	131707-063	right + left for tablet	arancio/orange ral2003
●	131707-064	left + right for tablet	arancio/orange ral2003
●	131703-063	right + left for tablet	nero/black ral9005
●	131703-064	left + right for tablet	nero/black ral9005
●	131716-063	right + left for tablet	verde/green pantone 7495el
●	131716-064	left + right for tablet	verde/green pantone 7495el
○	131705-063	right + left for tablet	bianco/white 218
○	131705-064	left + right for tablet	bianco/white 218
●	131704-063	right + left for tablet	grigio/grey ral7003
●	131704-064	left + right for tablet	grigio/grey ral7003
●	131707-060	right + left for tablet	sabbia/sand ral1019
●	131707-061	left + right for tablet	sabbia/sand ral1019
●	131702-063	right + left for tablet	rosso/red ral527
●	131702-064	left + right for tablet	rosso/red ral527





moon



discover more about
Moon Collection

La seduta dallo schienale portante che le garantisce un design distintivo. Massima stabilità e stile grazie allo schienale esterno portante in plastica, bianca o nera, che può essere a vista o con pannello aggiuntivo da tappezzare, e che costituisce un tutt'uno sia con la base slitta sia con il telaio 4 gambe.

Moon è ideale per il front office e le meeting room.

Chair with supportive backrest featuring an eye-catching design. Superb stability and style thanks to the supportive backrest in white or black plastic, which can be visible or with an additional panel to be upholstered, and which forms a single piece with both the sled base and 4-legged frame.

Moon is ideal for front office and meeting rooms.

Plus

- Design distintivo.
- Estrema comodità.
- Massima stabilità del telaio.
- Qualità certificata CATAS.
- Certificazione EN 15373:2007 Livello 3.
- Certificazione EN 13761:2002.
- *Distinctive design.*
- *Extreme comfort.*
- *Maximum stability of the frame.*
- *CATAS certified quality.*
- *EN 15373:2007 Level 3 Certification.*
- *EN 13761:2002 Certification.*



**certified
product**

moon

slide



CERTIFIED BY
CATAS

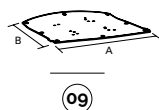
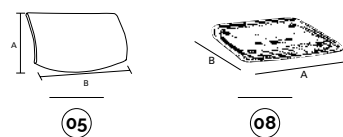
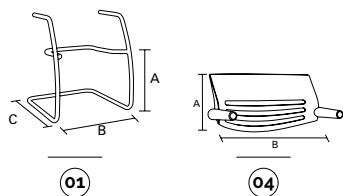
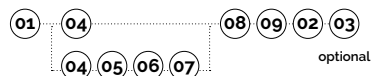

03 piedino antiribaltamento in plastica
plastic black feet anti-upsetting



01 moon-base a slitta in tubo asform d.25 tappi esclusi
moon-slide frame pipe d. 25 without caps

code	finishing	q.kit	q.pack	a	b	c	kg.x1	vol.x1
110503-120	● nero/black	x1	36	450	560	550	4,80	mc. 0,045
110504-120	● grigio/grey ikea 4	x1	36	450	560	550	4,80	mc. 0,045
110510-120	● cromato/chrome	x1	36	450	560	550	4,80	mc. 0,045

02 p2p-pinza due pioli in polietilene nera
p2p-two pins pliers in black polythene

code	finishing	q.kit
134003-003	● nero/black	x6

03 piedino antiribaltamento in plastica
plastic black feet anti-upsetting

code	finishing	q.kit	q.pack
134303-006	● nero/black	x2	100

04 moon-schienale esterno portante con accessori
moon-inside back carrier with accessories

code	finishing	q.kit	q.pack	a	b	kg.x1	vol.x1
132103-052	● nero/black	x1	12	270	510	1,60	mc. 0,017
132105-052	○ bianco/white	x1	12	270	510	1,60	mc. 0,017

05 moon-pannello schienale da tappezzare
moon-back pannel for upholstery

code	finishing	q.kit	q.pack	a	b	kg.x1	vol.x1
132103-053	● nero/black	x1	20	300	400	0,29	mc. 0,003

06 vite hilo tlb+ 5x12 clipper zincata nera
screw hilo tlb+ 5x12 clipper zinc black

code	finishing	q.kit
117803-151	● nero/black	x6

07 coprivite clipper in plastica
screw cover clipper in plastic

code	finishing	q.kit
134403-200	● nero/black	x6
134405-200	○ bianco/white	x6

08 moon-sedile interno da tappezzare
moon-inside seat to be upholstered

code	finishing	q.kit	q.pack	a	b	kg.x1	vol.x1
132203-061	● nero/black	x1	10	490	470	1,90	mc. 0,011

09 moon-sottosedile esterno plastica nero + 8 viti
moon-external black plastic underseat + 8 screws

code	finishing	q.kit	q.pack	a	b	kg.x1	vol.x1
132203-064	● nero/black	x1	20	470	440	0,57	mc. 0,0025

main component sizes

optionals

moon

4-legs

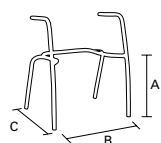
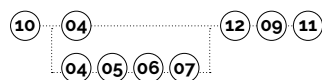

10



12

main component sizes

10 moon-telaio quattro gambe d.25 senza tappi
moon-four legs frame d.25 without caps

code	finishing	q.kit	q.pack	a	b	c	kg.x1	vol.x1
112603-060	● nero/black	x1	30	450	560	550	3,60	mc. 0.045
112604-060	● grigio/grey ikea 4	x1	30	450	560	550	3,60	mc. 0.045
112610-060	● cromato/chrome	x1	30	450	560	550	3,60	mc. 0.045

11 confezione puntali a testa sferica d.25
cap d.25 spherical head black package

code	finishing	q.kit	q.pack
137003-075	● nero/black	x4	120

12 moon-sedile interno da tappezzare per 4 gambe
moon-inside seat to be upholstered for 4 legs

code	finishing	q.kit	q.pack	a	b	kg.x1	vol.x1
132203-063	● nero/black	x1	10	490	470	1,90	mc. 0.011

for the components below, see previous page

04 05 06 07 09



magix



discover more about
Magix Collection

La seduta dai caratteristici e confortevoli braccioli strutturali. Un telaio tubolare in metallo dal design assolutamente distintivo, previsto in varie finiture. Disponibili inoltre diverse versioni dello schienale: tradizionale, alto o basso, da tappezzare o trapezoidale da tappezzare, in rete o plastica a vista. Grazie alla vasta gamma di componenti, due tipi di braccioli a scelta e due opzioni di sedile, Magix è adattabile a un ampio numero di telai per un assortimento completo.

Magix è la soluzione ideale per ambiente conference, meeting room o per il front office.

The chair featuring distinctive and comfortable structural armrests. A tubular metal frame with a highly distinctive design, available in a range of finishes. Different versions of the backrest are also available: traditional, high or low, to be upholstered or trapezoidal to be upholstered, in mesh or bare plastic. Thanks to the wide range of components, choice of two types of armrest and two seat options, Magix can be adapted to a large number of frames to provide an extensive range of options.

Magix is the ideal solution for conference and meeting room environments or for front offices.

Plus

- Vasta gamma di componenti sia per lo schienale sia per il sedile.
- Estremamente versatile e completa.
- Certificazione EN 16139:2013 Livello 1.
- *Wide range of components for both the backrest and the seat.*
- *Extremely versatile and complete.*
- *EN 16139:2013 Level 1 Certification.*



**certified
product**

magix

slide



CERTIFIED BY
CATAS

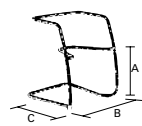
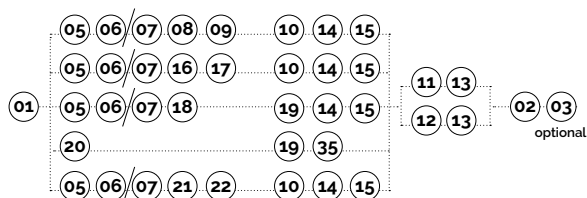
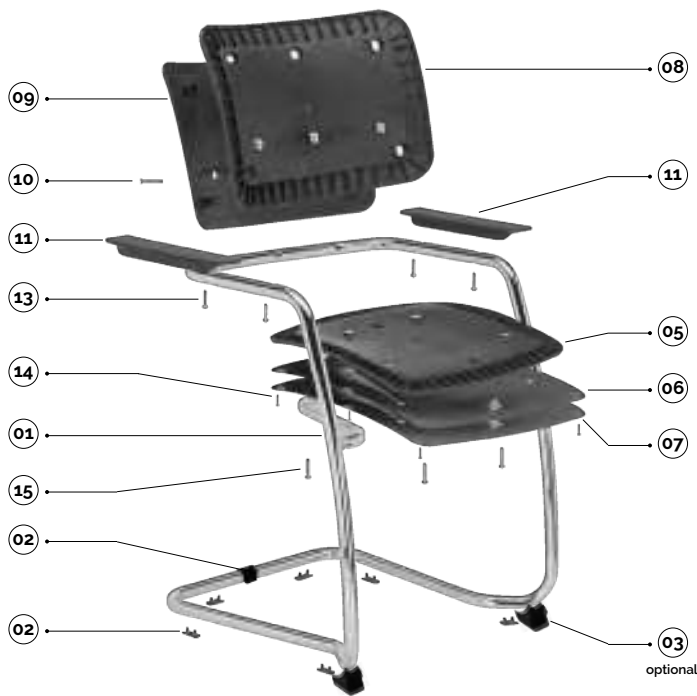

01

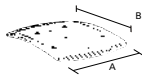

05



06



07

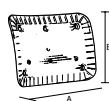

08

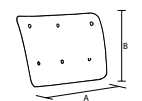

09

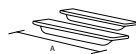

11



03



01 magix-base a slitta in tubo asform d.25 tappi esclusi
magix-slide frame pipe d.25 without caps

code	finishing	q.kit	q.pack	a	b	c	kg.x1	vol.x1
110503-009	● nero/black	x1	48	450	560	560	4,90	mc. 0,045
110504-112	● grigio/grey (su scatola)	x1	24	450	560	560	4,90	mc. 0,045
110510-095	● cromato/chrome	x1	48	450	560	560	4,90	mc. 0,045

02 magix-confezione accessori 50 picma + 290 p2pa
magix-pack of accessories 50 picma + 290 p2pa

code	finishing	q.kit	q.pack	kg.x1	vol.x1
137000-009	● nero/black	x1x6	50+290	1,00	mc. 0,1413

03 piedino antibaltamento in plastica nero + viti
plastic black feet anti-upsetting + screws

code	finishing	q.kit	q.pack	kg.x1	vol.x1
134303-006	● nero/black	x2	100	0,025	mc. 0,0001

05 magix sdi-sedile interno plastica nero
magix sdi-black plastic inner seat

code	finishing	q.kit	q.pack	a	b	kg.x1	vol.x1
132203-035	● nero/black	x1	10	480	460	1,10	mc. 0,045

06 magix sde-sedile esterno plastica nero
magix sde-black plastic external seat

code	finishing	q.kit	q.pack	a	b	kg.x1	vol.x1
132203-036	● nero/black	x1	20	450	420	0,34	mc. 0,051

07 magix sde-sedile esterno plastica nero per slitta
magix sde-black plastic external seat for slide frame

code	finishing	q.kit	q.pack	a	b	kg.x1	vol.x1
132203-037	● nero/black	x1	20	450	420	0,436	mc. 0,051

08 magix shi-schienale interno plastica nero
magix shi-black plastic inner back

code	finishing	q.kit	q.pack	a	b	kg.x1	vol.x1
132103-040	● nero/black	x1	20	470	290	0,95	mc. 0,004

09 magix she-schienale esterno plastica nero
magix she-black plastic external back

code	finishing	q.kit	q.pack	a	b	kg.x1	vol.x1
132103-041	● nero/black	x1	20	470	290	0,26	mc. 0,055

11 bracciolo destro e sinistro plastica nero
left right black plastic arm

code	finishing	q.kit	q.pack	a	kg.x1	vol.x1
131703-040	● nero/black	x2	100	200	0,04	mc. 0,0004

13 confezioni viti trucioliari tsp+ d.4x25 zincate (per fissare braccioli)
shaving screws tsp+ d.4x25 zinc package (for arms)

code	finishing	q.kit	q.pack
117011-072	○ zincata/zinc	x4	200

14 confezione viti tbl+ fr. d.5x14 brunita nera
screws tbl+ fr.hilo d.5x14 burnished black package

code	finishing	q.kit	q.pack
117003-071	● nero/black	x6	200

15 vite tsp+m6x35 zincata per il sedile
screw tsp+m6x35 zinc for the seat

code	finishing	q.kit
117711-183	○ zincata/zinc	x4

10 vite tspcei m6x40
screw tspcei m6x40

code	finishing	q.kit
117711-250	○ zincata/zinc	x3

main component sizes

optionals

magix

slide/armrest option

main component sizes

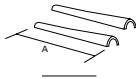

12



12 bracciolo destro e sinistro plastica conico left right black plastic conic arm

code	finishing	q.kit	q.pack	a	kg.x1	vol.x1
131703-041	● nero/black	x2	200	205	0,04	mc. 0.0002

slide/backrest and seat options

main component sizes

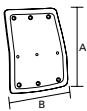

16



16 magix shi-schienale interno alto plastica nero magix shi-inside black plastic inner back

code	finishing	q.kit	q.pack	a	b	kg.x1	vol.x1
132103-043	● nero/black	x1	20	540	450	1,80	mc. 0.0055

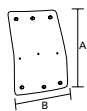

17

17 magix she-schienale alto esterno plastica nero magix she-black plastic external high back

code	finishing	q.kit	q.pack	a	b	kg.x1	vol.x1
132103-042	● nero/black	x1	20	540	450	0,50	mc. 0.0069

and · 10 14 15 13

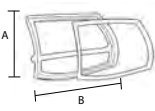

18



18 schienale e cornice per rete urban outer back and open frame for urban net

code	finishing	q.kit	q.pack	a	b	kg.x1	vol.x1
132103-037	● nero/black	x1	10	288	453	0,98	mc. 0.015

19 vite tspcei m6x35 screw tspcei m6x35

code	finishing	q.kit
117711-180	○ zincata/zinc	x3

and · 14 15 13

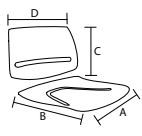

20



20 sedile e schienale a vista urban seat and back sight urban

Moq: 500pz/order

code	finishing	q.kit	q.pack	a	b	c	d	kg.x1	vol.x1
134003-112	● nero/black	x1	10	452	425	288	453	2,5	mc. 0.016
134004-112	● grigio/grey	x1	10	452	425	288	453	2,5	mc. 0.016
134005-112	○ bianco/white	x1	10	452	425	288	453	2,5	mc. 0.016

19 vite tspcei m6x35 screw tspcei m6x35

code	finishing	q.kit
117711-180	○ zincata/zinc	x3

35 vite autoflettante ts* 5,5x38 zincata screw autothreading ts* 5,5x38 flared cross

code	finishing	q.kit
117811-165	○ zincata/zinc	x4

and · 13

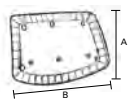

21



21 schienale interno urban inner back urban

code	finishing	q.kit	q.pack	a	b	kg.x1	vol.x1
132103-039	● nero/black	x1	20	450	540	0,77	mc. 0.006

22 schienale esterno urban outer back urban

code	finishing	q.kit	q.pack	a	b	kg.x1	vol.x1
132103-038	● nero/black	x1	20	450	540	0,24	mc. 0.006

and · 10 14 15 13

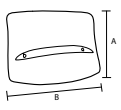

22

magix

4-legs

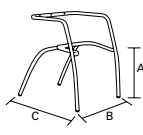
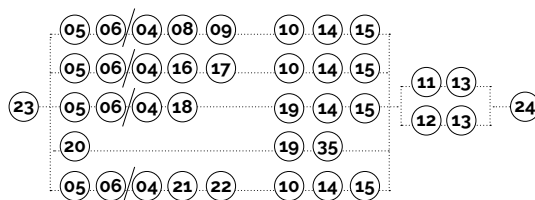
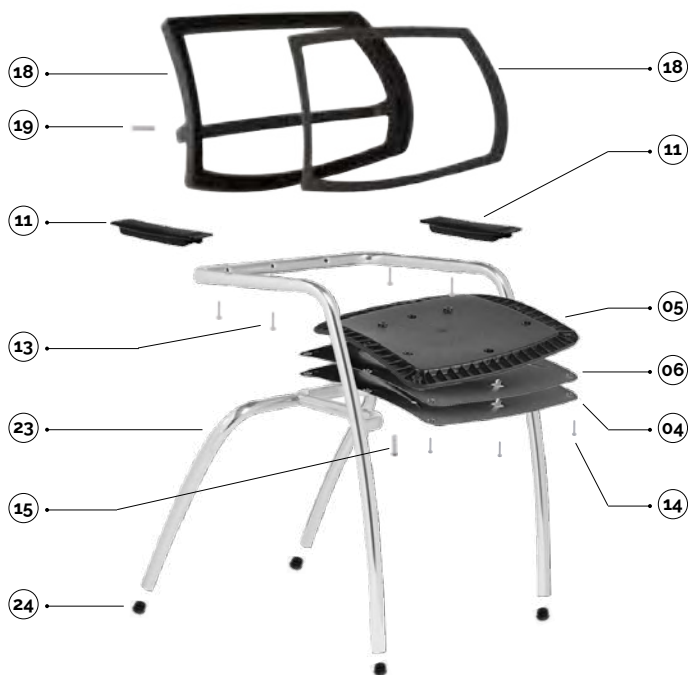

23

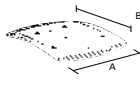

05



06



04



18

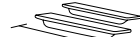

11

main component sizes

23 magix-telaio quattro gambe d.25 senza tappi
magix-four legs frame d.25 without caps

code	finishing	q.kit	q.pack	a	b	c	kg.x1	vol.x1
110103-006	● nero/black	x1	30	450	550	550	4.10	mc. 0.045
110104-006	● grigio/grey	x1	30	450	550	550	4.10	mc. 0.045
110110-006	● cromato/chrome	x1	30	450	550	550	4.10	mc. 0.045

24 confezione puntali a testa sferica d.25
cap d.25 spherical head black package

code	finishing	q.kit	q.pack
137003-075	● nero/black	x4	120

05 magix sdi-sedile interno plastica nero
magix sdi-black plastic inner seat

code	finishing	q.kit	q.pack	a	b	kg.x1	vol.x1
132203-035	● nero/black	x1	10	480	460	1.10	mc. 0.045

06 magix sde-sedile esterno plastica nero
magix sde-black plastic external seat

code	finishing	q.kit	q.pack	a	b	kg.x1	vol.x1
132203-036	● nero/black	x1	20	450	420	0.34	mc. 0.051

04 magix sde-sedile esterno plastica nero per telaio 4 gambe
magix sde-black plastic external seat for 4-legs frame

code	finishing	q.kit	q.pack	a	b	kg.x1	vol.x1
132203-038	● nero/black	x1	20	450	420	0.452	mc. 0.051

18 schienale e cornice per rete urban
outer back and open frame for urban net

code	finishing	q.kit	q.pack	a	b	kg.x1	vol.x1
132103-037	● nero/black	x1	10	288	453	0.98	mc. 0.015

11 bracciolo destro e sinistro plastica nero
left right black plastic arm

code	finishing	q.kit	q.pack	a	kg.x1	vol.x1
131703-040	● nero/black	x2	100	200	0.04	mc. 0.0004

13 confezioni viti trucioliari tsp+ d.4x25 zincate (per fissare braccioli)
shaving screws tsp+ d.4x25 zinc package (for arms)

code	finishing	q.kit	q.pack
117011-072	○ zincata/zinc	x4	200

14 confezione viti tbl+ fr. d.5x14 brunita nera
screws tbl+ fr.hilo d.5x14 burnished black package

code	finishing	q.kit	q.pack
117003-071	● nero/black	x6	200

15 vite tsp+m6x35 zincata per il sedile
screw tsp+m6x35 zinc for the seat

code	finishing	q.kit
117711-183	○ zincata/zinc	x4

19 vite tspcei m6x35
screw tspcei m6x35

code	finishing	q.kit
117711-180	○ zincata/zinc	x3

magix

4-legs/armrest option

main component sizes

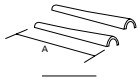

12



12 bracciolo destro e sinistro plastica conico
left right black plastic conic arm

code	finishing	q.kit	q.pack	a	kg.x1	vol.x1
131703-041	● nero/black	x2	200	205	0,04	mc. 0.0002

4-legs/backrest and seat options

main component sizes

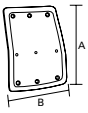

16



16 magix shi-schienale interno alto plastica nero
magix shi-inside black plastic inner back

code	finishing	q.kit	q.pack	a	b	kg.x1	vol.x1
132103-043	● nero/black	x1	20	540	450	1,80	mc. 0.0055

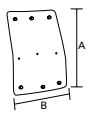

17

17 magix she-schienale alto esterno plastica nero
magix she-black plastic external high back

code	finishing	q.kit	q.pack	a	b	kg.x1	vol.x1
132103-042	● nero/black	x1	20	540	450	0,50	mc. 0.0069

and · **10** **14** **15** **13**

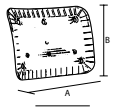

08



08 magix shi-schienale interno plastica nero
magix shi-black plastic inner back

code	finishing	q.kit	q.pack	a	b	kg.x1	vol.x1
132103-040	● nero/black	x1	20	470	290	0,95	mc. 0.004

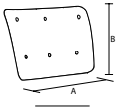

09

09 magix she-schienale esterno plastica nero
magix she-black plastic external back

code	finishing	q.kit	q.pack	a	b	kg.x1	vol.x1
132103-041	● nero/black	x1	20	470	290	0,26	mc. 0.055

and · **10** **14** **15** **13**

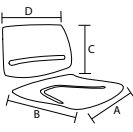

20



20 sedile e schienale a vista urban
seat and back sight urban

code	finishing	q.kit	q.pack	a	b	c	d	kg.x1	vol.x1
134003-112	● nero/black	x1	10	452	425	288	453	2,5	mc. 0.016
134004-112	● grigio/grey	x1	10	452	425	288	453	2,5	mc. 0.016
134005-112	○ bianco/white	x1	10	452	425	288	453	2,5	mc. 0.016

and · **19** **35** **13**

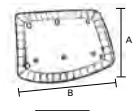

21



21 schienale interno urban
inner back urban

code	finishing	q.kit	q.pack	a	b	kg.x1	vol.x1
132103-039	● nero/black	x1	20	450	540	0,77	mc. 0.006

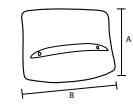

22

22 schienale esterno urban
outer back urban

code	finishing	q.kit	q.pack	a	b	kg.x1	vol.x1
132103-038	● nero/black	x1	20	450	540	0,24	mc. 0.006

and · **10** **14** **15** **13**

magix

4-legs for castors

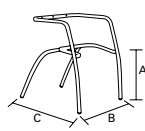
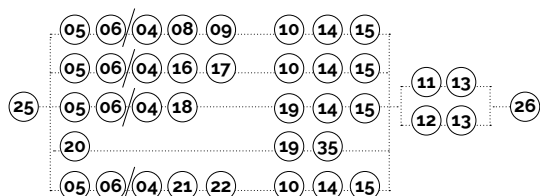
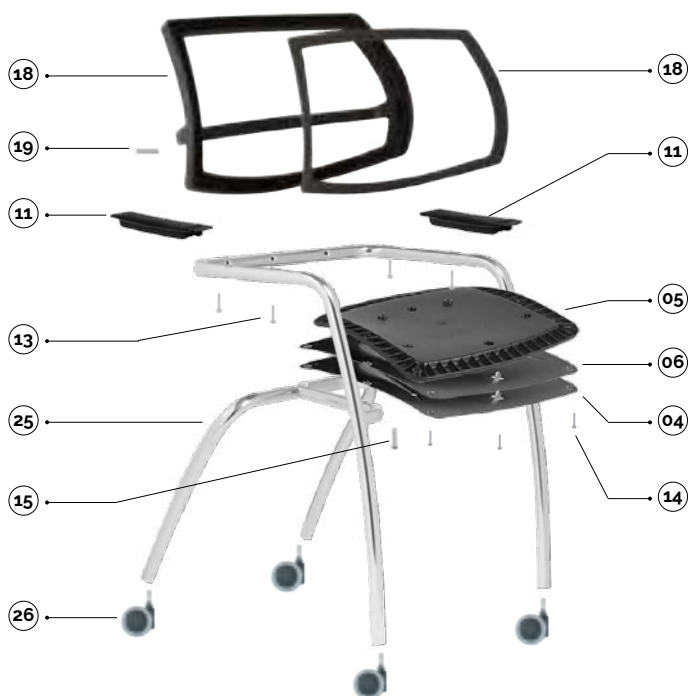

25

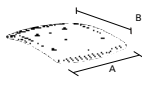

05



06



04



18

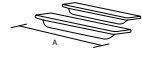

11

main component sizes

25 magix-telaio quattro gambe d.25 con riduttori per ruote
magix-four legs frame d.25 with adapter for castor

code	finishing	q.kit	q.pack	a	b	c	kg.x1	vol.x1
110103-005	● nero/black	x1	30	450	550	550	3,90	mc. 0,045
110104-005	● grigio/grey	x1	30	450	550	550	3,90	mc. 0,045
110110-005	● cromato/chrome	x1	30	450	550	550	3,90	mc. 0,045

26 doppia ruota d.50 in desmopan con perno montato
twin wheel castor d.50 desmopan with pivot mounted

code	finishing	q.kit
134403-003	● nero/black	x4

05 magix sdi-sedile interno plastica nero
magix sdi-black plastic inner seat

code	finishing	q.kit	q.pack	a	b	kg.x1	vol.x1
132203-035	● nero/black	x1	10	480	460	1,10	mc. 0,045

06 magix sde-sedile esterno plastica nero
magix sde-black plastic external seat

code	finishing	q.kit	q.pack	a	b	kg.x1	vol.x1
132203-036	● nero/black	x1	20	450	420	0,34	mc. 0,051

04 magix sde-sedile esterno plastica nero per telaio 4 gambe
magix sde-black plastic external seat for 4-legs frame

code	finishing	q.kit	q.pack	a	b	kg.x1	vol.x1
132203-038	● nero/black	x1	20	450	420	0,452	mc. 0,051

18 schienale e cornice per rete urban
outer back and open frame for urban net

code	finishing	q.kit	q.pack	a	b	kg.x1	vol.x1
132103-037	● nero/black	x1	10	288	453	0,98	mc. 0,015

11 bracciolo destro e sinistro plastica nero
left right black plastic arm

code	finishing	q.kit	q.pack	a	kg.x1	vol.x1
131703-040	● nero/black	x2	100	200	0,04	mc. 0,0004

13 confezioni viti trucioliari tsp+ d.4x25 zincate (per fissare braccioli)
shaving screws tsp+ d.4x25 zinc package (for arms)

code	finishing	q.kit	q.pack
117011-072	○ zincata/zinc	x4	200

14 confezione viti tbl+ fr. d.5x14 brunita nera
screws tbl+ fr.hilo d.5x14 burnished black package

code	finishing	q.kit	q.pack
117003-071	● nero/black	x6	200

15 vite tsp+m6x35 zincata per il sedile
screw tsp+m6x35 zinc for the seat

code	finishing	q.kit
117711-183	○ zincata/zinc	x4

19 vite tspcei m6x35
screw tspcei m6x35

code	finishing	q.kit
117711-180	○ zincata/zinc	x3

magix

4-legs for castors/armrest option

main component sizes

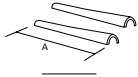

12



12 bracciolo destro e sinistro plastica conico
left right black plastic conic arm

code	finishing	q.kit	q.pack	a	kg.x1	vol.x1
131703-041	● nero/black	x2	200	205	0,04	mc. 0.0002

4-legs for castors/backrest and seat options

main component sizes

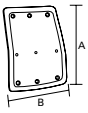

16



16 magix shi-schienale interno alto plastica nero
magix shi-inside black plastic inner back

code	finishing	q.kit	q.pack	a	b	kg.x1	vol.x1
132103-043	● nero/black	x1	20	540	450	1,80	mc. 0.0055

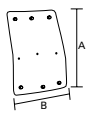

17



17 magix she-schienale alto esterno plastica nero
magix she-black plastic external high back

code	finishing	q.kit	q.pack	a	b	kg.x1	vol.x1
132103-042	● nero/black	x1	20	540	450	0,50	mc. 0.0069

and · 10 14 15 13

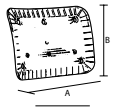

08



08 magix shi-schienale interno plastica nero
magix shi-black plastic inner back

code	finishing	q.kit	q.pack	a	b	kg.x1	vol.x1
132103-040	● nero/black	x1	20	470	290	0,95	mc. 0.004

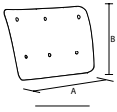

09



09 magix she-schienale esterno plastica nero
magix she-black plastic external back

code	finishing	q.kit	q.pack	a	b	kg.x1	vol.x1
132103-041	● nero/black	x1	20	470	290	0,26	mc. 0.055

and · 10 14 15 13

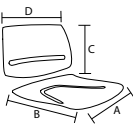

20



20 sedile e schienale a vista urban
seat and back sight urban

code	finishing	q.kit	q.pack	a	b	c	d	kg.x1	vol.x1
134003-112	● nero/black	x1	10	452	425	288	453	2,5	mc. 0.016
134004-112	● grigio/grey	x1	10	452	425	288	453	2,5	mc. 0.016
134005-112	○ bianco/white	x1	10	452	425	288	453	2,5	mc. 0.016

and · 19 35 13

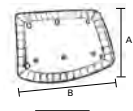

21



21 schienale interno urban
inner back urban

code	finishing	q.kit	q.pack	a	b	kg.x1	vol.x1
132103-039	● nero/black	x1	20	450	540	0,77	mc. 0.006

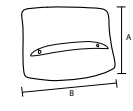

22



22 schienale esterno urban
outer back urban

code	finishing	q.kit	q.pack	a	b	kg.x1	vol.x1
132103-038	● nero/black	x1	20	450	540	0,24	mc. 0.006

and · 10 14 15 13

magix

swivel

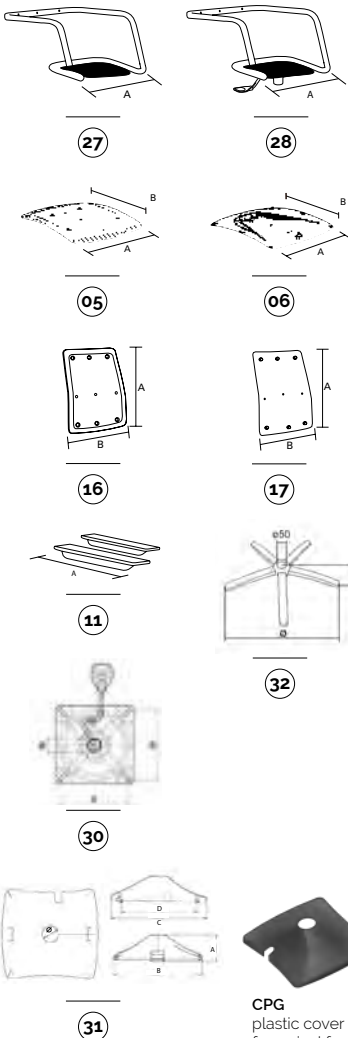
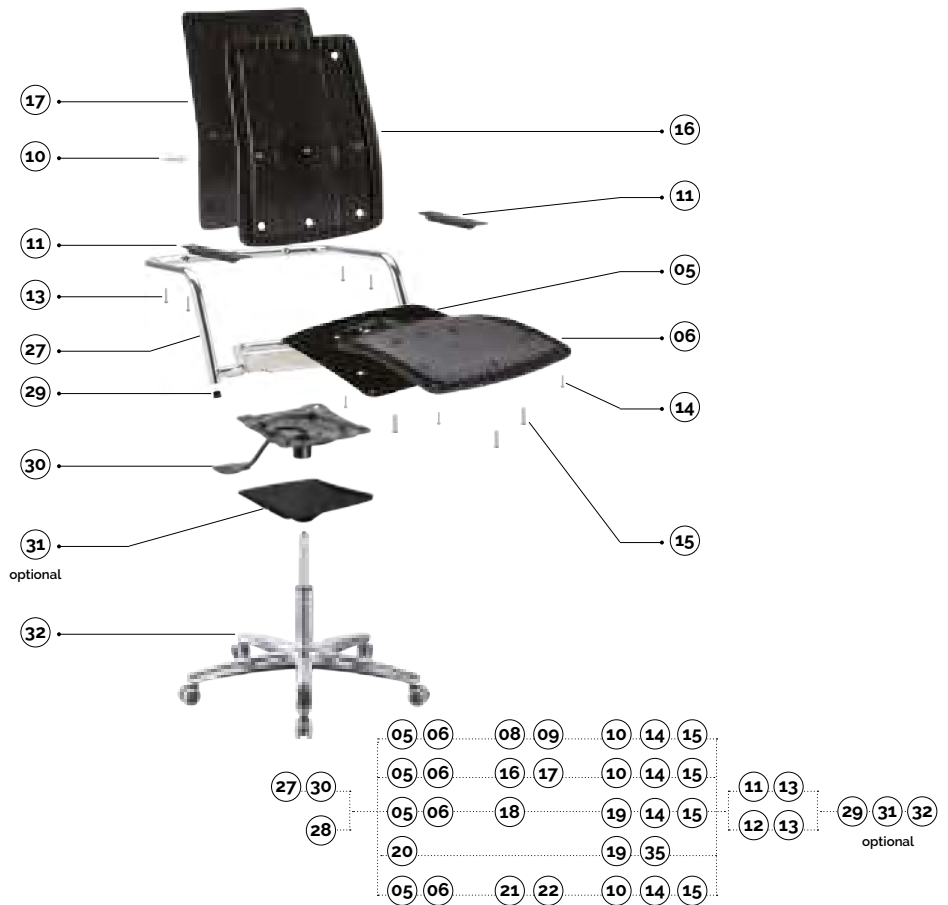

main component sizes

optionals

27	magix-telaio girevole d.25 con braccioli senza tappi magix-d.25 swivelmetal frame arms without caps									
code	finishing	q.kit	q.pack	a	kg.x1	vol.x1				
110910-034	● cromato/chrome	x1	50	550	5,00	mc. 0.045				
110903-034	● nero/black	x1	50	550	5,00	mc. 0.045				
28	magix(01)gc-telaio girevole d.25 con braccioli senza tappi + spatola magix(01)gc-d.25 swivelmetal frame arms without caps with gas plate welded									
code	finishing	q.kit								
110910-033	● cromato/chrome	x1	50	550	5,00	mc. 0.045				
110903-037	● nero/black	x1	50	550	5,00	mc. 0.045				
05	magix sdi-sedile interno plastica nero magix sdi-black plastic inner seat									
code	finishing	q.kit	q.pack	a	b	kg.x1	vol.x1			
132203-035	● nero/black	x1	10	480	460	1,10	mc. 0.045			
06	magix sde-sedile esterno plastica nero magix sde-black plastic external seat									
code	finishing	q.kit	q.pack	a	b	kg.x1	vol.x1			
132203-036	● nero/black	x1	20	450	420	0,34	mc. 0.051			
16	magix shi-schienale interno alto plastica nero magix shi-inside black plastic inner back									
code	finishing	q.kit	q.pack	a	b	kg.x1	vol.x1			
132103-043	● nero/black	x1	20	540	450	1,80	mc. 0.0055			
17	magix she-schienale alto esterno plastica nero magix she-black plastic external high back									
code	finishing	q.kit	q.pack	a	b	kg.x1	vol.x1			
132103-042	● nero/black	x1	20	540	450	0,50	mc. 0.0069			
10	vite tspcei m6x40 screw tspcei m6x40									
code	finishing	q.kit								
117711-250	○ zincata/zinc	x3								
11	bracciolo destro e sinistro plastica nero left right black plastic arm									
code	finishing	q.kit	q.pack	a	kg.x1	vol.x1				
131703-040	● nero/black	x2	100	200	0,04	mc. 0.0004				
13	confezioni viti trucciolari tsp+ d.4x25 zincate (per fissare braccioli) shaving screws tsp+ d.4x25 zinc package (for arms)									
code	finishing	q.kit	q.pack							
117011-072	○ zincata/zinc	x4	200							
30	pss28nr-piastra sgabello c/spat. c/28 3' l4 nera pss28nr- square metal plate with straight lever c/28 3' l4									
code	finishing	q.kit	q.pack	a	b	ø	kg.x1	vol.x1		
113003-104	● nero/black	x1	25	150	150	28	1,23	mc. 0.002		
31	cpg-copertina in plastica per telaio girevole cpg-plastic cover for swivel frame									
code	finishing	q.kit	q.pack	a	b	c	d	ø	kg.x1	vol.x1
130903-000	● nero/black	x1	50	60	200	210	167	36	0,1	mc. 0.0015
32	b40 base in metallo d.640 con coprisaldatura b40 metal base d.640 with cover welding									
code	finishing	q.kit	q.pack	a	ø	kg.x1	vol.x1			
110210-027	● cromato/chrome	x1	5	60	640	2,85	mc. 0.014			
14	confezione viti tbl+ fr. d.5x14 brunita nera screws tbl+ fr.hilo d.5x14 burnished black package									
code	finishing	q.kit	q.pack							
117003-071	● nero/black	x6	200							
29	tappo copritesta alettato d.25 nero cover head d.25 black									
code	finishing	q.kit								
134103-250	● nero/black	x2								
15	vite tsp+m6x35 zincata per il sedile screw tsp+m6x35 zinc for the seat									
code	finishing	q.kit								
117711-183	○ zincata/zinc	x4								

magix

swivel/armrest option

main component sizes

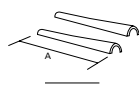

12



12 bracciolo destro e sinistro plastica conico
left right black plastic conic arm

code	finishing	q.kit	q.pack	a	kg.x1	vol.x1
131703-041	● nero/black	x2	200	205	0,04	mc. 0.0002

swivel/backrest and seat options

main component sizes

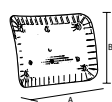

08



08 magix shi-schienale interno plastica nero
magix shi-black plastic inner back

code	finishing	q.kit	q.pack	a	b	kg.x1	vol.x1
132103-040	● nero/black	x1	20	470	290	0,95	mc. 0.004

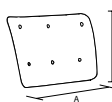

09

09 magix she-schienale esterno plastica nero
magix she-black plastic external back

code	finishing	q.kit	q.pack	a	b	kg.x1	vol.x1
132103-041	● nero/black	x1	20	470	290	0,26	mc. 0.055

and - **10** **14** **15** **13**



18



18 schienale e cornice per rete urban
outer back and open frame for urban net

code	finishing	q.kit	q.pack	a	b	kg.x1	vol.x1
132103-037	● nero/black	x1	10	288	453	0,98	mc. 0.015

19 vite tspcei m6x35
screw tspcei m6x35

code	finishing	q.kit
117711-180	○ zincata/zinc	x3

and - **14** **15** **13**

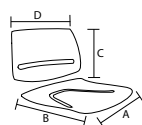

20



20 sedile e schienale a vista urban
seat and back sight urban

code	finishing	q.kit	q.pack	a	b	c	d	kg.x1	vol.x1
134003-112	● nero/black	x1	10	452	425	288	453	2,5	mc. 0.016
134004-112	● grigio/grey	x1	10	452	425	288	453	2,5	mc. 0.016
134005-112	○ bianco/white	x1	10	452	425	288	453	2,5	mc. 0.016

19 vite tspcei m6x35
screw tspcei m6x35

code	finishing	q.kit
117711-180	○ zincata/zinc	x3

and - **35** **13**

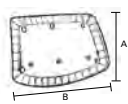

21



21 schienale interno urban
inner back urban

code	finishing	q.kit	q.pack	a	b	kg.x1	vol.x1
132103-039	● nero/black	x1	20	450	540	0,77	mc. 0.006

22 schienale esterno urban
outer back urban

code	finishing	q.kit	q.pack	a	b	kg.x1	vol.x1
132103-038	● nero/black	x1	20	450	540	0,24	mc. 0.006

and - **10** **14** **15** **13**

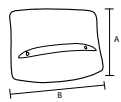

22

magix

bench

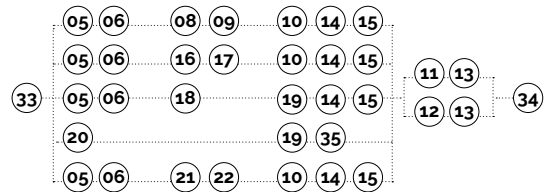

33 magix-telaio panca d.25 con braccioli senza tappi
magix-d.25 bench metal frame arms without caps

code	finishing	q.kit	q.pack	a	kg.x1	vol.x1
110710-200	● cromato/chrome	x1	60	550	5,00	mc. 0,045

20 sedile e schienale a vista urban
seat and back sight urban

code	finishing	q.kit	q.pack	a	b	c	d	kg.x1	vol.x1
134003-112	● nero/black	x1	10	452	425	288	453	2,5	mc. 0,016
134004-112	● grigio/grey	x1	10	452	425	288	453	2,5	mc. 0,016
134005-112	○ bianco/white	x1	10	452	425	288	453	2,5	mc. 0,016

19 vite tspcei m6x35
screw tspcei m6x35

code	finishing	q.kit
117711-180	○ zincata/zinc	x3

12 bracciolo destro e sinistro plastica conico
left right black plastic conic arm

code	finishing	q.kit	q.pack	a	kg.x1	vol.x1
131703-041	● nero/black	x2	200	205	0,04	mc. 0,0002

13 confezioni viti truciolari tsp+ d.4x25 zincate (per fissare braccioli)
shaving screws tsp+ d.4x25 zinc package (for arms)

code	finishing	q.kit	q.pack
117011-072	○ zincata/zinc	x4	200

35 vite autoflettante ts+ 5,5x38 zincata
screw autofthreading ts+ 5,5x38 flared cross

code	finishing	q.kit
117811-165	○ zincata/zinc	x4

29 tappo copritesta alettato d.25 nero
cover head d.25 black

code	finishing	q.kit
134103-250	● nero/black	x2

34 got(03) trave per panca 80x40
got(03) beam for bench 80x40

code	finishing	posti	q.kit	q.pack	a	b	c	kg.x1	vol.x1
110703-190	● nero/black	2 posti/2 seats	x1	1	1160	80	40	3,20	mc. 0,0045
110704-190	● grigio/grey	2 posti/2 seats	x1	1	1160	80	40	3,20	mc. 0,0045
110703-191	● nero/black	3 posti/3 seats	x1	1	1710	80	40	4,71	mc. 0,005
110704-191	● grigio/grey	3 posti/3 seats	x1	1	1710	80	40	4,71	mc. 0,005
110703-192	● nero/black	4 posti/4 seats	x1	1	2260	80	40	6,22	mc. 0,0085
110704-192	● grigio/grey	4 posti/4 seats	x1	1	2260	80	40	6,22	mc. 0,0085
110703-193	● nero/black	5 posti/5 seats	x1	1	2800	80	40	7,72	mc. 0,01
110704-197	● grigio/grey	5 posti/5 seats	x1	1	2800	80	40	7,72	mc. 0,01

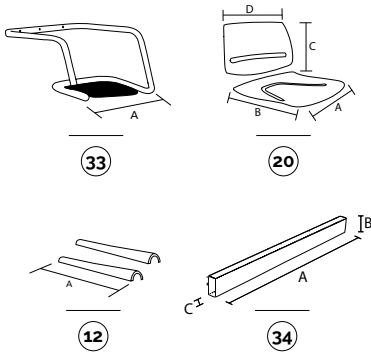

main component sizes

for the bench components, see page 417

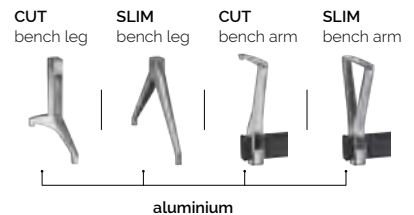
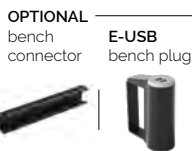

optionals

magix

bench/armrest option

main component sizes

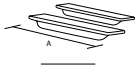

11



11 bracciolo destro e sinistro plastica nero
left right black plastic arm

code	finishing	q.kit	q.pack	a	kg.x1	vol.x1
131703-040	● nero/black	x2	100	200	0,04	mc. 0.0004

bench/backrest and seat options

main component sizes

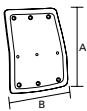

16



16 magix shi-schienale interno alto plastica nero
magix shi-inside black plastic inner back

code	finishing	q.kit	q.pack	a	b	kg.x1	vol.x1
132103-043	● nero/black	x1	20	540	450	1,80	mc. 0.0055

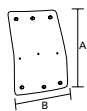

17

17 magix she-schienale alto esterno plastica nero
magix she-black plastic external high back

code	finishing	q.kit	q.pack	a	b	kg.x1	vol.x1
132103-042	● nero/black	x1	20	540	450	0,50	mc. 0.0069

and · **10** **14** **15** **13**

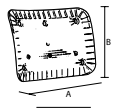

08



08 magix shi-schienale interno plastica nero
magix shi-black plastic inner back

code	finishing	q.kit	q.pack	a	b	kg.x1	vol.x1
132103-040	● nero/black	x1	20	470	290	0,95	mc. 0.004

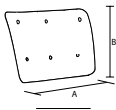

09

09 magix she-schienale esterno plastica nero
magix she-black plastic external back

code	finishing	q.kit	q.pack	a	b	kg.x1	vol.x1
132103-041	● nero/black	x1	20	470	290	0,26	mc. 0.055

and · **10** **14** **15** **13**

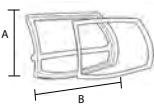

18



18 schienale e cornice per rete urban
outer back and open frame for urban net

code	finishing	q.kit	q.pack	a	b	kg.x1	vol.x1
132103-037	● nero/black	x1	10	288	453	0,98	mc. 0.015

and · **19** **14** **15** **13**

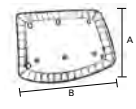

21



21 schienale interno urban
inner back urban

code	finishing	q.kit	q.pack	a	b	kg.x1	vol.x1
132103-039	● nero/black	x1	20	450	540	0,77	mc. 0.006

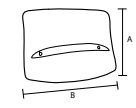

22

22 schienale esterno urban
outer back urban

code	finishing	q.kit	q.pack	a	b	kg.x1	vol.x1
132103-038	● nero/black	x1	20	450	540	0,24	mc. 0.006

and · **10** **14** **15** **13**



young / key / fabric



discover more about
Young Collection



discover more about
Key Collection



discover more about
Fabric Collection

Young, Key e Fabric, le nuove scocche in legno multistrato di faggio. Tre scocche dal design distintivo, con foro centrale, a T o da tappezzare, tutte compatibili con i telai della famiglia Magix, in grado di consentire il massimo delle combinazioni.

Young, Key e Fabric sono ideali per l'ambiente Office.

Young, Key and Fabric, the new seat shells in beech plywood. Three seat shells with a distinctive design, with central hole, T-shaped or to be upholstered, all compatible with the frames in the Magix family, thus providing an extensive range of combinations.

Young, Key and Fabric are ideal for Office environments.

Plus

- Scocca in legno multistrato di faggio.
- 5 colorazioni disponibili della scocca a vista.
- Linea ergonomica.
- Massima versatilità.
- La versione da tappezzare permette l'unicità di finitura.
- *Seat shell in beech plywood.*
- *Seat shell available in 5 colours.*
- *Ergonomic shape.*
- *Maximum versatility.*
- *The version to be upholstered enables a unique look to be achieved.*

young slide

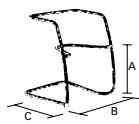
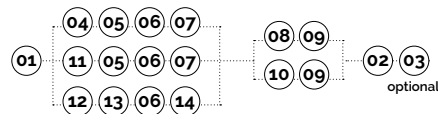

01

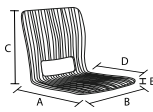

04



08



03



main component sizes

optionals

01 magix-base a slitta in tubo asform d.25 tappi esclusi
magix-slide frame pipe d.25 without caps

code	finishing	q.kit	q.pack	a	b	c	kg.x1	vol.x1
110503-009	● nero/black	x1	48	450	560	560	4,90	mc. 0,045
110504-112	● grigio/grey	x1	48	450	560	560	4,90	mc. 0,045
110510-095	● cromato/chrome	x1	48	450	560	560	4,90	mc. 0,045

02 magix-confezione accessori 50 picma + 290 p2pa
magix-pack of accessories 50 picma + 290 p2pa

code	finishing	q.kit	q.pack	kg.x1	vol.x1
137000-009	● nero/black	x1+x6	50+290	1,00	mc. 0,1413

03 piedino antibaltamento in plastica nero + viti
plastic black feet anti-upsetting + screws

code	finishing	q.kit	q.pack	kg.x1	vol.x1
134303-006	● nero/black	x2	100	0,025	mc. 0,0001

04 magix/young-monoscocca mult. ver. c/inserti
magix/young beech shell w/inserts

code	finishing	q.kit	q.pack	a	b	c	d	e	kg.x1	vol.x1
122107-015	● faggio/plywood	x1	5	556	487	396	396	11	3,11	mc. 0,0312
122115-015	● azzurro/blue	x1	5	556	487	396	396	11	3,11	mc. 0,0312
122116-015	● verde/green	x1	5	556	487	396	396	11	3,11	mc. 0,0312
122104-015	● tempesta/grey blue	x1	5	556	487	396	396	11	3,11	mc. 0,0312
122107-021	● arancione/orange	x1	5	556	487	396	396	11	3,11	mc. 0,0312

05 vite 4.8 tsp+ m6x30-zincata per il sedile
screw 4.8 tsp+ m6x30-zinc for the seat

code	finishing	q.kit
117711-192	○ zincata/zinc	x4

06 supporto schienale scocca legno
spacer for plywood shell

code	finishing	q.kit	q.pack	kg.x1	vol.x1
132103-077	● nero/black	x1	100	0,26	mc. 0,055
132105-077	○ avorio/ivory ral1013	x1	100	0,26	mc. 0,055

07 vite tspei m5x40 zincata bianca per lo schienale
screw tspei m5x40 white zinc for the back

code	finishing	q.kit
117711-154	○ zincata bianca/white zinc	x3

08 bracciolo destro e sinistro plastica conico
left right black plastic conic arm

code	finishing	q.kit	q.pack	a	kg.x1	vol.x1
131703-041	● nero/black	x2	200	205	0,04	mc. 0,0002
131703-042	○ avorio/ivory ral1013	x2	200	205	0,04	mc. 0,0002

09 confezioni viti trucciolari tsp+ d.4x25 zincate (per fissare braccioli)
shaving screws tsp+ d.4x25 zinc package (for arms)

code	finishing	q.kit	q.pack
117011-072	○ zincata/zinc	x4	200

young

slide/armrest option

main component sizes

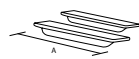

10



10 bracciolo destro e sinistro plastica nero
left right black plastic arm

code	finishing	q.kit	q.pack	a	kg.x1	vol.x1
131703-040	● nero/black	x2	100	200	0,04	mc. 0.0004

slide/shell options

main component sizes

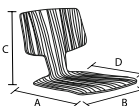

11



11 magix/key-monoscozza mult. ver. c/inserti
magix/key beech shell w/inserts

code	finishing	q.kit	q.pack	a	b	c	d	kg.x1	vol.x1
122107-016	● faggio/plywood	x1	5	552	483	398	391	2,76	mc. 0.0312
122115-016	● azzurro/blue	x1	5	552	483	398	391	2,76	mc. 0.0312
122116-016	● verde/green	x1	5	552	483	398	391	2,76	mc. 0.0312
122104-016	● tempesta/grey blue	x1	5	552	483	398	391	2,76	mc. 0.0312
122107-022	● arancione/orange	x1	5	552	483	398	391	2,76	mc. 0.0312

and **05** **07**

spessore 11mm
thickness 11mm

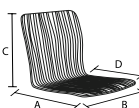

12



12 magix/fabric-monosc. mult. faggio x imbottiti c/inserti
magix/fabric beech shell for upholstery w/inserts

code	finishing	q.kit	q.pack	a	b	c	d	kg.x1	vol.x1
122107-017	● faggio/plywood	x1	5	556	487	396	396	3,50	mc. 0.0312

13 vite 4.8 tsp+ m6x35 zincata bianca per il sedile
screw 4.8 tsp+ m6x35-white zinc for the seat

code	finishing	q.kit
117711-183	● zincata bianca/white zinc	x4

14 vite tspei m5x45 zincata bianca per lo schienale
screw tspei m5x45 white zinc for the back

code	finishing	q.kit
117711-156	● zincata bianca/white zinc	x3

spessore 11mm
thickness 11mm

key

4-legs

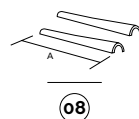
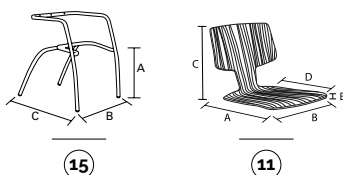
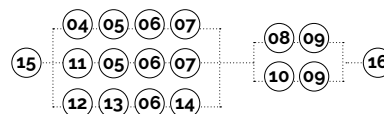
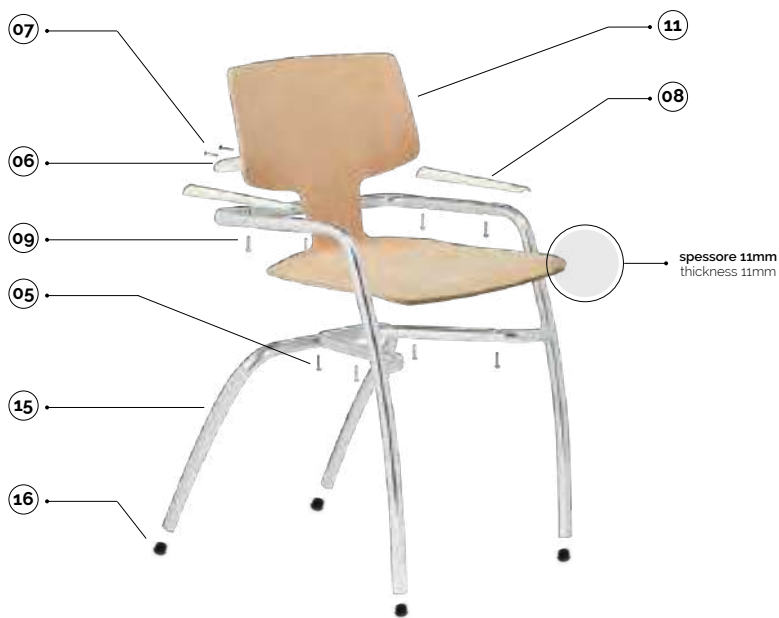

main component sizes

15 magix-telaio quattro gambe d.25 senza tappi magix-four legs frame d.25 without caps

code	finishing	q.kit	q.pack	a	b	c	kg.x1	vol.x1
110103-006	● nero/black	x1	30	450	550	550	4.10	mc. 0.045
110104-006	● grigio/grey	x1	30	450	550	550	4.10	mc. 0.045
110110-006	● cromato/chrome	x1	30	450	550	550	4.10	mc. 0.045

16 confezione puntali a testa sferica d.25 cap d.25 spherical head black package

code	finishing	q.kit	q.pack
137003-075	● nero/black	x4	120

11 magix/key-monoscocca mult. ver. c./inserti magix/key beech shell w/inserts

code	finishing	q.kit	q.pack	a	b	c	d	e	kg.x1	vol.x1
122107-016	● faggio/plywood	x1	5	552	483	398	391	11	2,76	mc. 0.0312
122115-016	● azzurro/blue	x1	5	552	483	398	391	11	2,76	mc. 0.0312
122116-016	● verde/green	x1	5	552	483	398	391	11	2,76	mc. 0.0312
122104-016	● tempesta/grey blue	x1	5	552	483	398	391	11	2,76	mc. 0.0312
122107-022	● arancione/orange	x1	5	552	483	398	391	11	2,76	mc. 0.0312

05 vite 4.8 tsp+ m6x30-zincata per il sedile screw 4.8 tsp+ m6x30-zinc for the seat

code	finishing	q.kit
117711-192	○ zincata/zinc	x4

06 supporto schienale scocca legno spacer for plywood shell

code	finishing	q.kit	q.pack	kg.x1	vol.x1
132103-077	● nero/black	x1	100	0,26	mc. 0.055
132105-077	○ avorio/ivory rat1013	x1	100	0,26	mc. 0.055

07 vite tspei m5x40 zincata bianca per lo schienale screw tspei m5x40 white zinc for the back

code	finishing	q.kit
117711-154	○ zincata bianca/white zinc	x3

08 bracciolo destro e sinistro plastica conico left right black plastic conic arm

code	finishing	q.kit	q.pack	a	kg.x1	vol.x1
131703-041	● nero/black	x2	200	205	0,04	mc. 0.0002
131703-042	○ avorio/ivory rat1013	x2	200	205	0,04	mc. 0.0002

09 confezioni viti trucciolari tsp+ d.4x25 zincate (per fissare braccioli) shaving screws tsp+ d.4x25 zinc package (for arms)

code	finishing	q.kit	q.pack
117011-072	○ zincata/zinc	x4	200

key

4-legs/armrest option

main component sizes

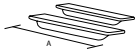

10



10 bracciolo destro e sinistro plastica nero left right black plastic arm

code	finishing	q.kit	q.pack	a	kg.x1	vol.x1
131703-040	● nero/black	x2	100	200	0,04	mc. 0.0004

4-legs/shell options

main component sizes

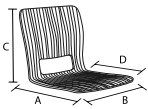

04



spessore 11mm
thickness 11mm

04 magix/young-monoscocca mult. ver. c/inserti magix/young beech shell w/inserts

code	finishing	q.kit	q.pack	a	b	c	d	kg.x1	vol.x1
122107-015	● faggio/plywood	x1	5	556	487	396	396	3,11	mc. 0.0312
122115-015	● azzurro/blue	x1	5	556	487	396	396	3,11	mc. 0.0312
122116-015	● verde/green	x1	5	556	487	396	396	3,11	mc. 0.0312
122104-015	● tempesta/grey blue	x1	5	556	487	396	396	3,11	mc. 0.0312
122107-021	● arancione/orange	x1	5	556	487	396	396	3,11	mc. 0.0312

and 05 07

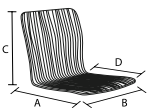

12



spessore 11mm
thickness 11mm

12 magix/fabric-monosc. mult. faggio x imbottiti c/inserti magix/fabric beech shell for upholstery w/inserts

code	finishing	q.kit	q.pack	a	b	c	d	kg.x1	vol.x1
122107-017	● faggio/plywood	x1	5	556	487	396	396	3,50	mc. 0.0312

13 vite 4.8 tsp+ m6x35 zincata bianca per il sedile screw 4.8 tsp+ m6x35-white zinc for the seat

code	finishing	q.kit
117711-183	● zincata bianca/white zinc	x4

14 vite tspei m5x45 zincata bianca per lo schienale screw tspei m5x45 white zinc for the back

code	finishing	q.kit
117711-156	● zincata bianca/white zinc	x3

key

4-legs for castors

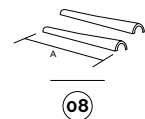
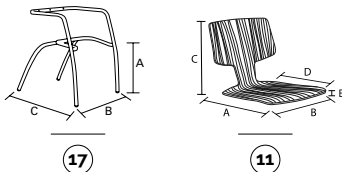
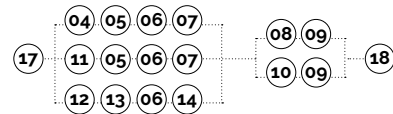

17 magix-telaio quattro gambe per ruote d.25 con riduttori
magix-four legs frame for castors d.25 with adapter

code	finishing	q.kit	q.pack	a	b	c	kg.x1	vol.x1
110103-005	● nero/black	x1	30	450	550	550	3,90	mc. 0,045
110104-005	● grigio/grey	x1	30	450	550	550	3,90	mc. 0,045
110110-005	● cromato/chrome	x1	30	450	550	550	3,90	mc. 0,045

18 doppia ruota d.50 in desmopan con perno montato
twin wheel castor d.50 desmopan with pivot mounted

code	finishing	q.kit
134403-003	● nero/black	x4

11 magix/key-monoscocca mult. ver. c/inserti
magix/key beech shell w/inserts

code	finishing	q.kit	q.pack	a	b	c	d	e	kg.x1	vol.x1
122107-016	● faggio/plywood	x1	5	552	483	398	391	11	2,76	mc. 0,0312
122115-016	● azzurro/blue	x1	5	552	483	398	391	11	2,76	mc. 0,0312
122116-016	● verde/green	x1	5	552	483	398	391	11	2,76	mc. 0,0312
122104-016	● tempesta/grey blue	x1	5	552	483	398	391	11	2,76	mc. 0,0312
122107-022	● arancione/orange	x1	5	552	483	398	391	11	2,76	mc. 0,0312

05 vite 4.8 tsp+ m6x30-zincata per il sedile
screw 4.8 tsp+ m6x30-zinc for the seat

code	finishing	q.kit
117711-192	○ zincata/zinc	x4

06 supporto schienale scocca legno
spacer for plywood shell

code	finishing	q.kit	q.pack	kg.x1	vol.x1
132103-077	● nero/black	x1	100	0,26	mc. 0,055
132105-077	○ avorio/ivory ral1013	x1	100	0,26	mc. 0,055

07 vite tspei m5x40 zincata bianca per lo schienale
screw tsppei m5x40 white zinc for the back

code	finishing	q.kit
117711-154	○ zincata bianca/white zinc	x3

08 bracciolo destro e sinistro plastica conico
left right black plastic conic arm

code	finishing	q.kit	q.pack	a	kg.x1	vol.x1
131703-041	● nero/black	x2	200	205	0,04	mc. 0,0002
131703-042	○ avorio/ivory ral1013	x2	200	205	0,04	mc. 0,0002

09 confezioni viti trucciolari tsp+ d.4x25 zincate (per fissare braccioli)
shaving screws tsp+ d.4x25 zinc package (for arms)

code	finishing	q.kit	q.pack
117011-072	○ zincata/zinc	x4	200

key

4-legs/armrest option

main component sizes

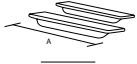

10

10 bracciolo destro e sinistro plastica nero
left right black plastic arm

code	finishing	q.kit	q.pack	a	kg.x1	vol.x1
131703-040	● nero/black	x2	100	200	0,04	mc. 0.0004

4-legs/shell options

main component sizes

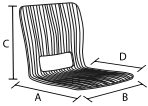

04



spessore 11mm
thickness 11mm

04 magix/young-monoscocca mult. ver. c/inserti
magix/young beech shell w/inserts

code	finishing	q.kit	q.pack	a	b	c	d	kg.x1	vol.x1
122107-015	● faggio/plywood	x1	5	556	487	396	396	3,11	mc. 0.0312
122115-015	● azzurro/blue	x1	5	556	487	396	396	3,11	mc. 0.0312
122116-015	● verde/green	x1	5	556	487	396	396	3,11	mc. 0.0312
122104-015	● tempesta/grey blue	x1	5	556	487	396	396	3,11	mc. 0.0312
122107-021	● arancione/orange	x1	5	556	487	396	396	3,11	mc. 0.0312

and **05** **07**

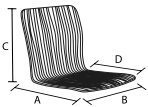

12



spessore 11mm
thickness 11mm

12 magix/fabric-monosc. mult. faggio x imbottiti c/inserti
magix/fabric beech shell for upholstery w/inserts

code	finishing	q.kit	q.pack	a	b	c	d	kg.x1	vol.x1
122107-017	● faggio/plywood	x1	5	556	487	396	396	3,50	mc. 0.0312

13 vite 4.8 tsp+ m6x35 zincata bianca per il sedile
screw 4.8 tsp+ m6x35-white zinc for the seat

code	finishing	q.kit
117711-183	● zincata bianca/white zinc	x4

14 vite tspei m5x45 zincata bianca per lo schienale
screw tspei m5x45 white zinc for the back

code	finishing	q.kit
117711-156	● zincata bianca/white zinc	x3

fabric

swivel

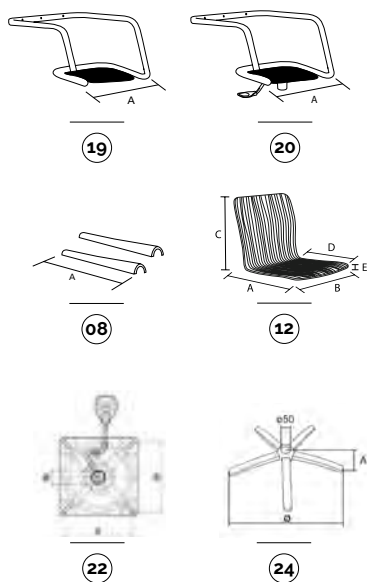
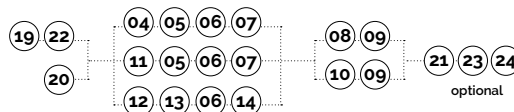

main component sizes

optionals

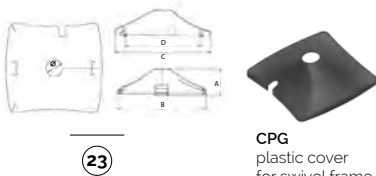

CPG
plastic cover
for swivel frame

19 magix-telaio girevole d.25 con braccioli senza tappi magix-d.25 swivel metal frame arms without caps

code	finishing	q.kit	q.pack	a	kg.x1	vol.x1
110910-034	● cromato/chrome	x1	50	550	5,00	mc. 0.045

20 magix(01)gc-telaio girevole d.25 con braccioli senza tappi con piastra saldata + spatola magix(01)gc-d.25 swivel metal frame arms without caps with gas plate welded + paddle

code	finishing	q.kit
110910-033	● cromato/chrome	x1 50 550

21 tappo copritesta alettato d.25 nero cover head d.25 black

code	finishing	q.kit
134103-250	● nero/black	x2

12 magix/fabric-monosc. mult. faggio x imbottiti c/inserti magix/fabric beech shell for upholstery w/inserts

code	finishing	q.kit	q.pack	a	b	c	d	e	kg.x1	vol.x1
122107-017	● faggio/plywood	x1	5	556	487	396	396	11	3,50	mc. 0.0312

13 vite 4.8 tsp+ m6x35 zincata bianca per il sedile screw 4.8 tsp+ m6x35-white zinc for the seat

code	finishing	q.kit
117711-183	○ zincata bianca/white zinc	x4

14 vite tspei m5x45 zincata bianca per lo schienale screw tspei m5x45 white zinc for the back

code	finishing	q.kit
117711-156	○ zincata bianca/white zinc	x3

06 supporto schienale scocca legno spacer for plywood shell

code	finishing	q.kit	q.pack	kg.x1	vol.x1
132103-077	● nero/black	x1	100	0,26	mc. 0.055
132105-077	○ avorio/ivory ral1013	x1	100	0,26	mc. 0.055

08 bracciolo destro e sinistro plastica conico left right black plastic conic arm

code	finishing	q.kit	q.pack	a	kg.x1	vol.x1
131703-041	● nero/black	x2	200	205	0,04	mc. 0.0002
131703-042	○ avorio/ivory ral1013	x2	200	205	0,04	mc. 0.0002

09 confezioni viti trucciolari tsp+ d.4x25 zincate (per fissare braccioli) shaving screws tsp+ d.4x25 zinc package (for arms)

code	finishing	q.kit	q.pack
117011-072	○ zincata/zinc	x4	200

22 pss28nr-piastra sgabello c/spat. c/28 3' l4 nera pss28nr- square metal plate with straight lever c/28 3' l4

code	finishing	q.kit	q.pack	a	b	o	kg.x1	vol.x1
113003-104	● nero/black	x1	25	150	150	28	1,23	mc. 0.002

23 cpg-copertina in plastica per telaio girevole cpg-plastic cover for swivel frame

code	finishing	q.kit	q.pack	a	b	c	d	o	kg.x1	vol.x1
130903-000	● nero/black	x1	50	60	200	210	167	36	0,1	mc. 0.0015

24 b40 base in metallo d.640 con coprisaldatura b40 metal base d.640 with cover welding

code	finishing	q.kit	q.pack	a	o	kg.x1	vol.x1
110210-027	● cromato/chrome	x1	5	60	640	2,85	mc. 0.014

young / key / fabric

bench

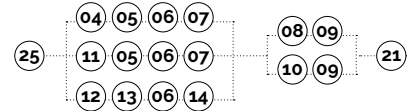

25 magix-telaio panca d.25 con braccioli senza tappi
magix-d.25 bench metal frame arms without caps

code	finishing	q.kit	q.pack	a	kg.x1	vol.x1
110710-200	● cromato/chrome	x1	60	550	5,00	mc. 0,045

26 got(03) trave per panca 80x40
got(03) beam for bench 80x40

code	finishing		q.kit	q.pack	a	b	c	kg.x1	vol.x1
110703-190	● nero/black	2 posti/2 seats	x1	1	1160	80	40	3,20	mc. 0,0045
110704-190	● grigio/grey	2 posti/2 seats	x1	1	1160	80	40	3,20	mc. 0,0045
110703-191	● nero/black	3 posti/3 seats	x1	1	1710	80	40	4,71	mc. 0,005
110704-191	● grigio/grey	3 posti/3 seats	x1	1	1710	80	40	4,71	mc. 0,005
110703-192	● nero/black	4 posti/4 seats	x1	1	2260	80	40	6,22	mc. 0,0085
110704-192	● grigio/grey	4 posti/4 seats	x1	1	2260	80	40	6,22	mc. 0,0085
110703-193	● nero/black	5 posti/5 seats	x1	1	2800	80	40	7,72	mc. 0,01
110704-197	● grigio/grey	5 posti/5 seats	x1	1	2800	80	40	7,72	mc. 0,01

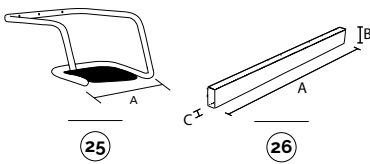

for the components below, see previous pages

for the components below, see previous pages

04 05 06 07 08 09

11

for the components below, see previous pages

for the bench components, see page 417

12 13 14 21

main component sizes

bench/armrest option



10 bracciolo destro e sinistro plastica nero
left right black plastic arm

code	finishing	q.kit	q.pack	a	kg.x1	vol.x1
131703-040	● nero/black	x2	100	200	0,04	mc. 0,0004

OPTIONAL
bench
connector

E-USB
bench plug

JIM
bench leg

90GM
bench leg

90GF
bench leg

91GM **NEW**
bench leg

100GM
bench leg

200GM
bench leg

PIONEER
bench arm

CUT
bench leg

SLIM
bench leg

CUT
bench arm

SLIM
bench arm



plastic



metal



aluminium

optionals



flash



discover more about
Flash Collection

Una seduta dal design moderno e geometrico che colpisce al primo sguardo e non rinuncia al comfort.

Lo schienale portante in plastica può essere associato a un telaio con base a slitta o quattro gambe.

Flash è pensata per un utilizzo front office.

The modern, geometric design of this chair immediately catches the eye without compromising comfort.

The supportive plastic backrest can be combined with a frame featuring a sled or four-legged base.

Flash has been designed for front office use.

flash

slide

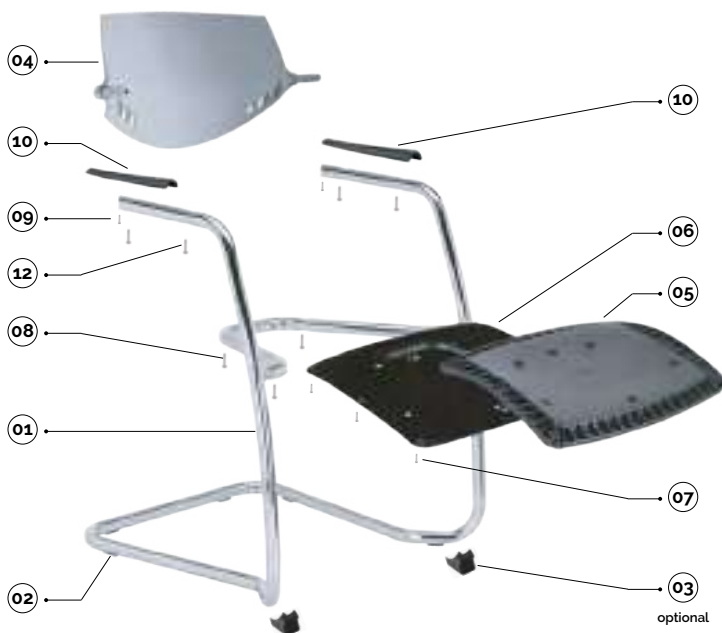

optional

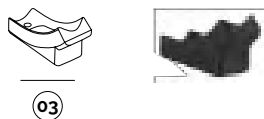
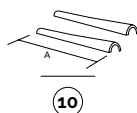
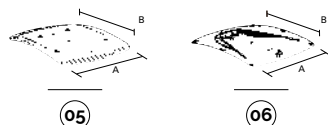
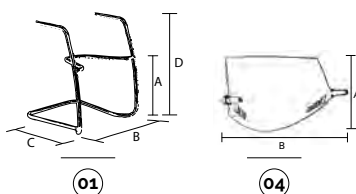
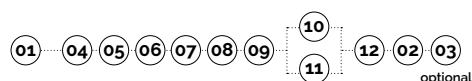

01 flash-base a slitta in tubo d.25 tappi esclusi
flash-slide frame pipe d.25 without caps

code	finishing	q.kit	q.pack	a	b	c	d	kg.x1	vol.x1
110503-071	● nero/black	x1	36	450	560	560	830	5,00	mc. 0.045
110504-071	● grigio/grey	x1	36	450	560	560	830	5,00	mc. 0.045
110510-071	● cromato/chrome	x1	36	450	560	560	830	5,00	mc. 0.045

02 pinza due pioli in polietilene nera
pliers two pin black

code	finishing	q.kit
134003-003	● nero/black	x6

03 piedino antiribaltamento in plastica nera
plastic black feet anti-upsetting

code	finishing	q.kit	q.pack	kg.x1	vol.x1
134303-006	● nero/black	x2	100	0,025	mc. 0.0001

04 flash-schienale in plastica
flash-plastic back

code	finishing	q.kit	q.pack	a	b	kg.x1	vol.x1
132103-070	● nero/black	x1	10	300	480	0,90	mc. 0.01
132104-070	● grigio/grey	x1	10	300	480	0,90	mc. 0.01

05 flash-sedile interno plastica nera
flash-black plastic inner seat

code	finishing	q.kit	q.pack	a	b	kg.x1	vol.x1
132203-035	● nero/black	x1	10	480	460	1,10	mc. 0.045

06 flash-sedile esterno plastica nera
flash-black plastic external seat

code	finishing	q.kit	q.pack	a	b	kg.x1	vol.x1
132203-036	● nero/black	x1	20	450	420	0,34	mc. 0.051

07 confezione viti tbl+ fr. d.5x14 brunita nera
screws tbl+ fr.hilo d.5x14 zinc.black package

code	finishing	q.kit	q.pack
117003-071	● nero/black	x6	200

08 vite 4.8tsp+m6x35 zincata
screw 4.8tsp+m6x35 zinc

code	finishing	q.kit
117711-183	○ zincata/zinc	x4

09 vite truciolare tsp+d.4x20 zincata (per fissaggio schienale)
shaving screw tsp+d.4x20 zinc (for fixing back)

code	finishing	q.kit
117811-121	○ zincata/zinc	x2

10 bracciolo destro e sinistro plastica conico
left right black plastic conic arm

code	finishing	q.kit	q.pack	a	kg.x1	vol.x1
131703-041	● nero/black	x2	200	205	0,04	mc. 0.0002

12 confezioni viti truciolari tsp+ d.4x25 zincate (per fissare braccioli)
shaving screws tsp+ d.4x25 zinc package

code	finishing	q.kit	q.pack
117011-072	○ zincata/zinc	x4	200

main component sizes

optionals

flash

4-legs

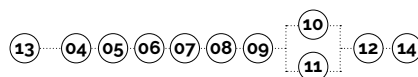
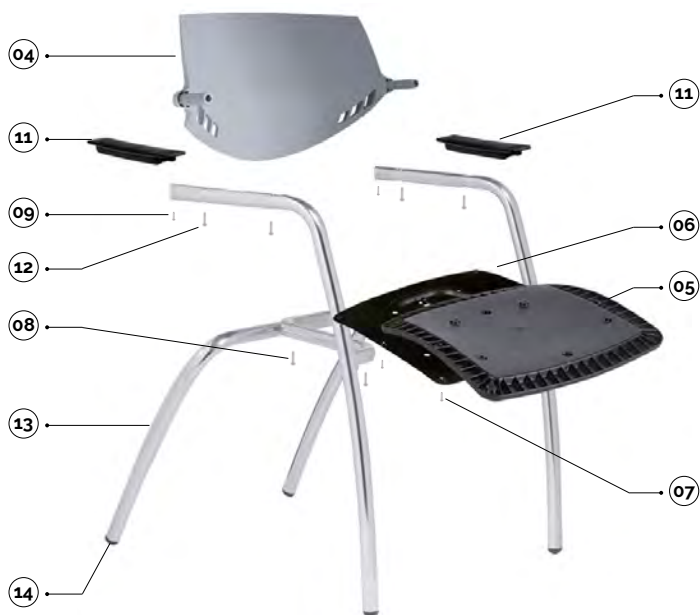

main component sizes

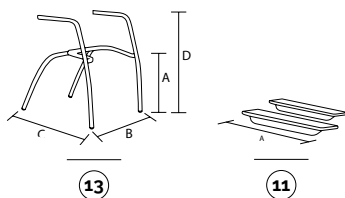

13 flash-telaio 4 gambe con braccioli in tubo d.25 tappi esclusi
flash-four legs frame pipe d.25 with arms without caps

code	finishing	q.kit	q.pack	a	b	c	d	kg.x1	vol.x1
110103-040	● nero/black	x1	30	450	550	570	830	3,60	mc. 0.045
110104-040	● grigio/grey	x1	30	450	550	570	830	3,60	mc. 0.045
110110-040	● cromato/chrome	x1	30	450	550	570	830	3,60	mc. 0.045

14 confezione puntali a testa sferica d.25
cap d.25 spherical head black package

code	finishing	q.kit	q.pack
137003-075	● nero/black	x4	120

11 bracciolo destro e sinistro plastica nero
left right black plastic arm

code	finishing	q.kit	q.pack	a	kg.x1	vol.x1
131703-040	● nero/black	x2	100	200	0,04	mc. 0.0004

for the components below, see previous page

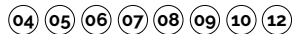

optionals



flash

swivel

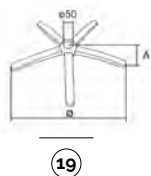
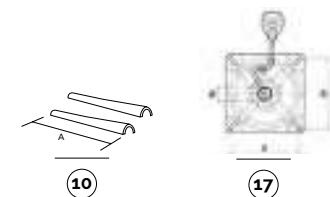
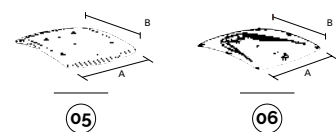
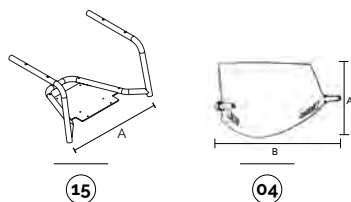
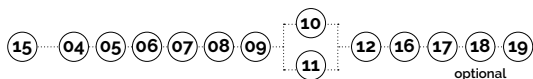
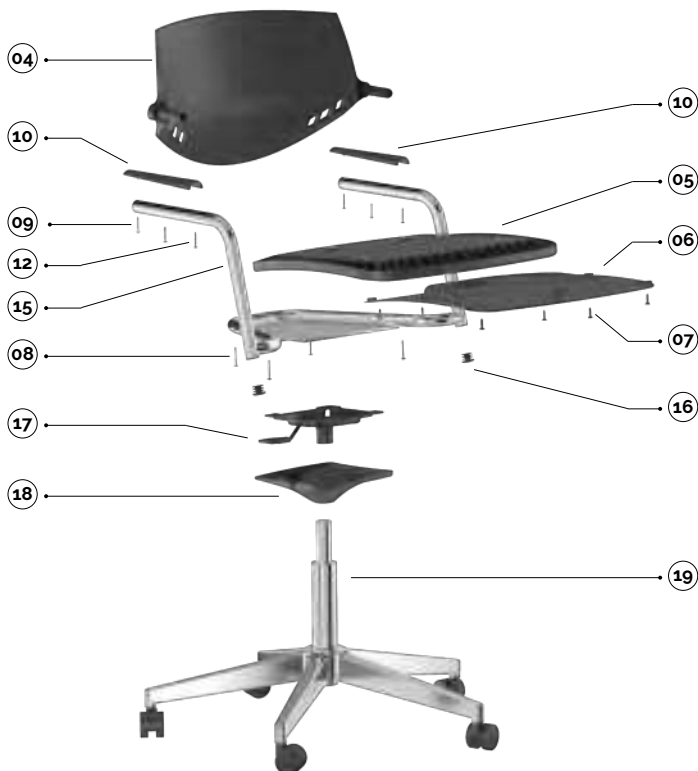

15 flash-telaio girevole Ø25 con braccioli senza tappi
flash-Ø25 swivel metal frame arms without caps

code	finishing	q.kit	q.pack	a
110910-302	● cromato/chrome	x1	50	550

16 flash-tappo copritesta alettato in plastica Ø25
flash-cover head Ø25

code	finishing	q.kit
134103-250	● nero/black	x2

17 pss28nr-piastra sgabello c/spat. c/28 3' l4 nera
pss28nr- square metal plate with straight lever c/28 3' l4

code	finishing	q.kit	q.pack	a	b	ø	kg.x1	vol.x1
113003-104	● nero/black	x1	25	150	150	28	1.23	mc. 0.002

18 cpg-copertina in plastica per telaio girevole
cpg-plastic cover for swivel frame

code	finishing	q.kit	q.pack	a	b	c	d	ø	kg.x1	vol.x1
130903-000	● nero/black	x1	50	60	200	210	167	36	0.1	mc. 0.0015

19 b40 base in metallo d.640 con coprisaldatura
b40 metal base d.640 with cover welding

code	finishing	q.kit	q.pack	a	ø	kg.x1	vol.x1
110210-027	● cromato/chrome	x1	5	60	640	2.85	mc. 0.014

for the components below, see previous pages

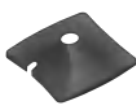
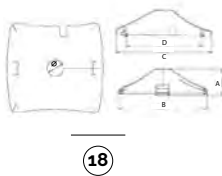
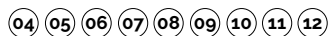

CPG
plastic cover
for swivel frame

main component sizes

optionals





q9



discover more about
Q9 Collection

Un concetto innovativo di monoscocca, dal disegno distintivo e dalle dimensioni generose.

Nata per arredare con importanza e grande carattere sia il front office sia le meeting room.

Disponibile sia con pannelli da tappezzare sia con cornice per schienale in rete, risulta perfetta in tutte le situazioni.

An innovative monocoque concept, with an eye-catching design and generous dimensions.

Designed to furnish both front office and meeting rooms and confer importance and great character.

Available both with panels to be upholstered and with optional frame for a mesh backrest, making it perfect in all settings.

q9

slide

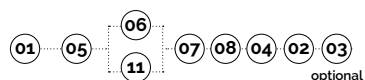

main component sizes

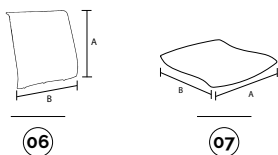
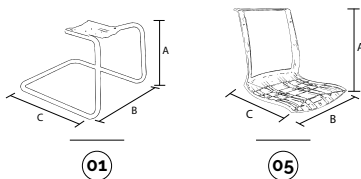

optionals

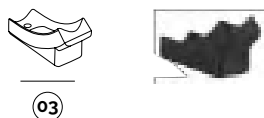

01 q9-base a slitta in tubo d.25 tappi esclusi

q9-slide frame pipe d.25 without caps

code	finishing	q.kit	q.pack	a	b	c	kg.x1	vol.x1
110503-131	● nero/black	x1	64	400	560	550	4.10	mc. 0.032
110504-131	● grigio/grey	x1	64	400	560	550	4.10	mc. 0.032
110510-111	● cromato/chrome	x1	64	400	560	550	4.10	mc. 0.032

02 pinza due pioli in polietilene nera

pliers two pin black

code	finishing	q.kit
134003-003	● nero/black	x6

03 piedino antiribaltamento in plastica nera

plastic black feet anti-upsetting

code	finishing	q.kit	q.pack	kg.x1	vol.x1
134303-006	● nero/black	x2	100	0.025	mc. 0.0001

04 tappo copritesta d.25

cover head cap d.25

code	finishing	q.kit
134110-250	● cromato/chrome	x2
134103-250	● nero/black	x2

05 q9-monoscocca in plastica+confezione

q9-plastic shell + packaging

code	finishing	q.kit	q.pack	a	b	c	kg.x1	vol.x1
133903-007	● nero/black	x1	5	550	480	480	3.20	mc. 0.021
133905-007	○ bianco/white	x1	5	550	480	480	3.20	mc. 0.021

06 q9-pannello schienale in plastica da tappezzare

q9-frame back in plastic for upholstery

code	finishing	q.kit	q.pack	a	b	kg.x1	vol.x1
132103-061	● nero/black	x1	10	460	460	1.30	mc. 0.01
132105-012	○ bianco/white	x1	10	460	460	1.30	mc. 0.01

07 q9-pannello sedile in plastica da tappezzare

q9-frame seat in plastic for upholstery

code	finishing	q.kit	q.pack	a	b	kg.x1	vol.x1
132203-040	● nero/black	x1	10	480	480	0.80	mc. 0.009

08 vite testa cilindrica a croce m6x16 zincata (per fissare scocca)

screw cylindrical cross head m6x16 zinc (for fix shell)

code	finishing	q.kit
117711-191	○ zincata/zinc	x4

q9

slide w/armrests

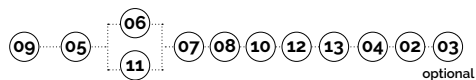

main component sizes

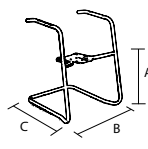

09



11

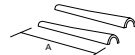

12

optionals



03



09 q9-base a slitta con braccioli in tubo d.25 tappi esclusi
q9-slide frame pipe d.25 with arms without caps

code	finishing	q.kit	q.pack	a	b	c	kg.x1	vol.x1
110503-095	● nero/black	x1	36	400	560	550	5,60	mc. 0.045
110504-132	● grigio/grey	x1	36	400	560	550	5,60	mc. 0.045
110510-132	● cromato/chrome	x1	36	400	560	550	5,60	mc. 0.045

10 tappo copritesta cromato d.25
cover head cap d.25 chrome

code	finishing	q.kit
134110-250	● cromato/chrome	x2

11 q9-cornice schienale in plastica per rete
q9-plastic back frame for mesh

code	finishing	q.kit	q.pack	a	b	kg.x1	vol.x1
132103-060	● nero/black	x1	20	460	460	0,52	mc. 0.007
132105-011	○ bianco/white	x1	20	460	460	0,52	mc. 0.007

12 q9-bracciolo destro e sinistro plastica conico
q9-black plastic conic arm

code	finishing	q.kit	q.pack	a	kg.x1	vol.x1
131703-041	● nero/black	x2	200	205	0,04	mc. 0.0002

13 confezioni viti trucciolari tsp+ d.4x25 zincate (per fissare braccioli)
shaving screws tsp+ d.4x25 zinc package

code	finishing	q.kit	q.pack
117011-072	○ zincata/zinc	x4	200

for the components below, see previous page

02 03 04 05 07 08

q9 bench

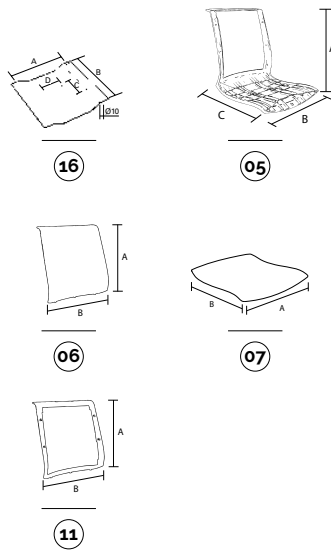
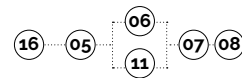

16 g2p(01)-piastra per attacco scocca su panca g2p(01)-metal plate for shell fixing on benches

code	finishing	q.kit	q.pack	a	b	c	d	kg.x1	vol.x1
110703-013	● nero/black	x1	25	153	200	65	55	0,85	mc. 0002

05 q9-monoscocca in plastica+confezione q9-plastic shell + packaging

code	finishing	q.kit	q.pack	a	b	c	kg.x1	vol.x1
133903-007	● nero/black	x1	5	550	480	480	3,20	mc. 0.021
133905-007	○ bianco/white	x1	5	550	480	480	3,20	mc. 0.021

06 q9-pannello schienale in plastica da tappezzare q9-frame back in plastic for upholstery

code	finishing	q.kit	q.pack	a	b	kg.x1	vol.x1
132103-061	● nero/black	x1	10	460	460	1,30	mc. 0.01
132105-012	○ bianco/white	x1	10	460	460	1,30	mc. 0.01

11 q9-cornice schienale in plastica per rete q9-plastic back frame for mesh

code	finishing	q.kit	q.pack	a	b	kg.x1	vol.x1
132103-060	● nero/black	x1	20	460	460	0,52	mc. 0.007
132105-011	○ bianco/white	x1	20	460	460	0,52	mc. 0.007

07 q9-pannello sedile in plastica da tappezzare q9-frame seat in plastic for upholstery

code	finishing	q.kit	q.pack	a	b	kg.x1	vol.x1
132203-040	● nero/black	x1	10	480	480	0,80	mc. 0.009

08 vite testa cilindrica a croce m6x16 zincata (per fissare scocca) screw cylindrical cross head m6x16 zinc (for fix shell)

code	finishing	q.kit
117711-191	○ zincata/zinc	x4

for the bench components, see page 417

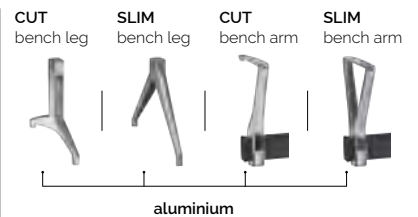
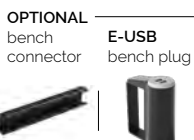

main component sizes

optionals





square



discover more about
Square Collection

La sedia versatile e caratterizzante. Ampia e confortevole, funzionale a utilizzi diversi, prevede schienale e sedile in diverse varianti: da tappezzare, in plastica a vista, con possibili pannellini da tappezzare, in multistrato faggio verniciato. Grazie alle numerose opzioni e versioni di telai disponibili, si adatta a molteplici utilizzi.

Square è indicata per l'ambiente Office e l'ambiente Contract.

A versatile and distinctive chair. A generous, comfortable and functional chair making it ideal for diverse settings. Available in a range of backrest and seat variations: to be upholstered, in bare plastic, with the possibility of including a seat pad to be upholstered, in varnished beech plywood. Thanks to the large number of options and frame versions available, Square is suitable for multiple uses.

Square is suitable for Office and the Contract environments.

Plus

- Telaio con sezione del tubo rettangolare che la contraddistingue sul mercato.
- Seduta ampia e confortevole.
- Massima versatilità.
- Qualità certificata CATAS.
- Certificazione EN 16139:2013+AC:2013 Livello 1.
- Certificazione ANSI/BIFMA X5.1.
- *Frame with highly distinctive rectangular-section tube.*
- *Features a generous, comfortable seat.*
- *Maximum versatility.*
- *CATAS certified quality.*
- *EN 16139:2013+AC:2013 Level 1 Certification.*
- *ANSI/BIFMA X5.1 Certification.*



designed by:
R&D Alba



**trolley
available**



**certified
product**

square

4-legs



CERTIFIED BY
BIFMA
CATAS

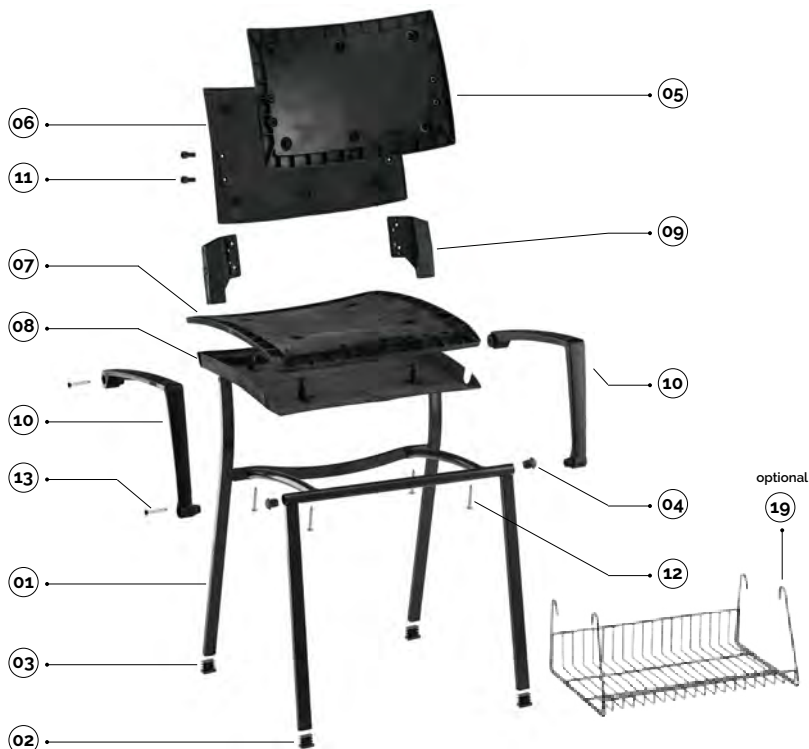

square-carrello portasedie con accessori
square-trolley for chairs with accessories

code	finishing	q.kit
110803-371	● nero/black	x1

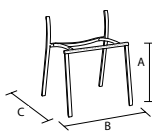
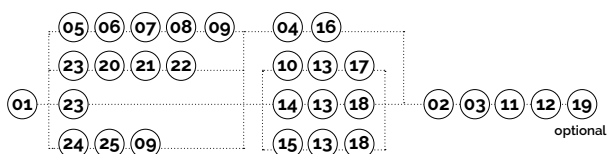

01

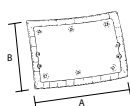

05

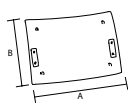

06

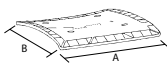

07

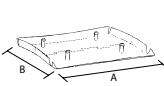

08

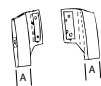

09

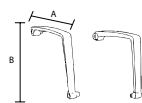

10

main component sizes

optionals

01 square-telaio per sedia fissa senza tappi sottopiede montati
square-fixed frame for chair without caps

code	finishing	q.kit	q.pack	a	b	c	kg.x1	vol.x1
112603-025	● nero/black	x1	72	450	500	500	3,20	mc. 0.003
112604-025	● grigio/grey	x1	72	450	500	500	3,20	mc. 0.003
112610-025	● cromato/chrome	x1	72	450	500	500	3,20	mc. 0.003

02 confezione puntali rettangolari 25x15
black inner flat rectangular caps 25x15 package

code	finishing	q.kit	q.pack	*forniti nella stessa confezione supplied in the same package	
137003-074'	● nero/black	x2	160		
134204-020	● grigio/grey	x2	160		

03 confezione puntali inclinati rettangolari 25x15
black inner oblique rectangular caps 25x15 package

code	finishing	q.kit	q.pack	*forniti nella stessa confezione supplied in the same package	
137003-074'	● nero/black	x2	160		
134204-023	● grigio/grey	x2	160		

04 tappo copritesta 022 per sedia senza braccioli
cover head cap 022 for chair without arms

code	finishing	q.kit
134103-220	● nero/black	x2
134104-220	● grigio/grey	x2

05 square-shi-schienale interno in plastica
square-shi-inner plastic back

code	finishing	q.kit	q.pack	a	b	kg.x1	vol.x1
132103-006	● nero/black	x1	20	440	290	0,55	mc. 0.004

06 square-she-schienale esterno in plastica
square-she-outer plastic back

code	finishing	q.kit	q.pack	a	b	kg.x1	vol.x1
132103-005	● nero/black	x1	20	425	280	0,37	mc. 0.004
132104-026	● grigio/grey	x1	20	425	280	0,37	mc. 0.004

07 square-sedile interno in plastica
square-inner plastic seat

code	finishing	q.kit	q.pack	a	b	kg.x1	vol.x1
132203-007	● nero/black	x1	20	440	460	0,90	mc. 0.005

08 square-sedile esterno in plastica
square-outer plastic seat

code	finishing	q.kit	q.pack	a	b	kg.x1	vol.x1
132203-006	● nero/black	x1	20	430	450	0,53	mc. 0.008
132204-026	● grigio/grey	x1	20	430	450	0,53	mc. 0.008

09 square-coppia supporti schienale in plastica
square-plastic pair of supports for back

code	finishing	q.kit	q.pack	a	kg.x1	vol.x1
134003-087	● nero/black	x1	40	25x15	0,16	mc. 0.0002
134004-022	● grigio/grey	x1	40	25x15	0,16	mc. 0.0002

10 square-coppia braccioli in plastica
square-plastic pair arms

code	finishing	q.kit	q.pack	a	b	kg.x1	vol.x1
131703-005	● nero/black	x1	10	360	260	0,70	mc. 0.006
131704-005	● grigio/grey	x1	10	360	260	0,70	mc. 0.006

19 square-cestello portariviste
square-basket tray

code	finishing	q.kit
113403-003	● nero/black	x1

11 vite testa cilindrica a croce m6x16 zincata
screw cylindrical cross head m6x16 zinc

code	finishing	q.kit
117711-191	○ zincata/zinc	x4

12 vite testa svasata a croce m6x30 zincata (vite per fissaggio sedile)
screw flared head m6x30 zinc (screw for six seat)

code	finishing	q.kit
117711-192	○ zincata/zinc	x4

13 vite autofilettante 5,5x45 testa svasata a croce
screw auto-threading 5,5x45 flared cross

code	finishing	q.kit
117811-168	○ zincata/zinc	x4

square

4-legs/tablet and hook options

optionals



14

15

14 15 bracciolo destro/sinistro con gancio portavoletta right/left arm with attachment for tablet

code	finishing		q.kit	q.pack	kg.x1	vol.x1
131703-009	● nero/black	destra/right	x1	20	0,70	mc. 0,006
131703-006	● nero/black	sinistra/left	x1	20	0,70	mc. 0,006
131704-003	● grigio/grey	destra/right	x1	20	0,70	mc. 0,006
131704-004	● grigio/grey	sinistra/left	x1	20	0,70	mc. 0,006



16

TLT tablet TLT2 tablet TLT3 tablet BEAN tablet TL02 tablet SPT2 mechanism tablet SPTA mechanism antipanic



for writing tablet options, see page 242/243

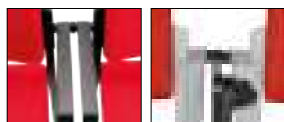

17

18

16 17 18 aggancio laterale maschio+femmina in plastica + 2 viti plastic lateral hook male+female and 2 screws

code	finishing		q.kit	q.pack	kg.x1	vol.x1
134003-130	● nero/black		x1	100	0,03	mc. 0,0001
134003-131	● nero/black	per bracciolo/for arm	x1	100	0,03	mc. 0,0001
134003-138	● nero/black	per bracciolo con portavoletta/ for arm with attachment for tablet	x1	100	0,03	mc. 0,0001

4-legs/backrest and seat options

main component sizes

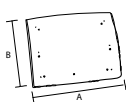

20

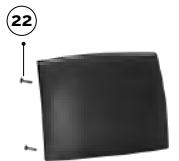

22

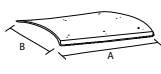

21



20 pannello schienale da tappezzare panel back for upholstery

code	finishing		q.kit	q.pack	a	b	kg.x1	vol.x1
132103-046	● nero/black		x1	20	390	310	0,50	mc. 0,004

21 pannello sedile da tappezzare panel seat for upholstery

code	finishing		q.kit	q.pack	a	b	kg.x1	vol.x1
132203-046	● nero/black		x1	20	400	450	0,60	mc. 0,004

22 confezione viti tbl+ fr. d.5x14 per pannello da tappezzare screws tbl+ fr.hilo d.5x14 zinc.black (to fix seat panel) package

code	finishing		q.kit	q.pack
117003-071	● nero/black		x4	200

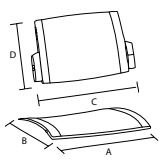

23



23 square-coppia sedile schienale in plastica colorato square-plastic seat/back coloured at sight

code	finishing		q.kit	q.pack	a	b	c	d	kg.x1	vol.x1
134003-088	● nero/black		x1	10	450	440	500	300	1,62	mc. 0,012
134004-023	● grigio/grey	RAL7040	x1	10	450	440	500	300	1,62	mc. 0,012
134002-023	● rosso/red	PPL42	x1	10	450	440	500	300	1,62	mc. 0,012
134015-023	● blu/blue	RAL5002	x1	10	450	440	500	300	1,62	mc. 0,012
134007-023	● arancio/orange	PPL22	x1	10	450	440	500	300	1,62	mc. 0,012
134005-023	● beige/beige	PPL09	x1	10	450	440	500	300	1,62	mc. 0,012

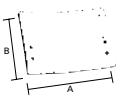

24



24 schienale in multistrato faggio + viti back in plywood beech with screws

code	finishing		q.kit	q.pack	a	b	kg.x1
122107-010	● faggio/beech wood		x1	15	425	280	0,50

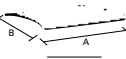

25



25 square sdlf-sedile multistrato faggio verniciato + viti square sdlf-painted beech wood seat with screws

code	finishing		q.kit	q.pack	a	b	kg.x1
122207-015	● faggio/beech wood		x1	15	422	280	1,65

square

4-legs for castors

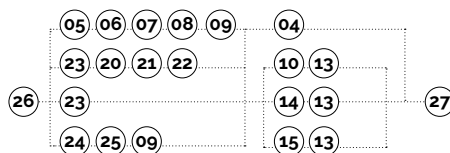

square-carrello portasedie con accessori
square-trolley for chairs with accessories

code	finishing	q.kit
110803-371	● nero/black	x1

26 telaio per sedia 4 gambe predisposto per 4 ruote + 4 tappi porta ruote
frame for chair issued for 4 wheels + 4 inner black caps for castors

code	finishing	q.kit	q.pack	a	b	c	kg.x1	vol.x1
112603-027	● nero/black	x1	80	450	500	500	3,10	mc. 0,003
112604-027	● grigio/grey	x1	80	450	500	500	3,10	mc. 0,003
112610-027	● cromato/chrome	x1	80	450	500	500	3,10	mc. 0,003

04 tappo copritesta 022 per sedia senza braccioli
cover head cap 022 for chair without arms

code	finishing	q.kit
134103-220	● nero/black	x2
134104-220	● grigio/grey	x2

23 square-coppia sedile schienale in plastica colorato
square-plastic seat/back coloured at sight

code	finishing	q.kit	q.pack	a	b	c	d	kg.x1	vol.x1
134003-088	● nero/black	x1	10	450	440	500	300	1,62	mc. 0,012
134004-023	● grigio/grey	x1	10	450	440	500	300	1,62	mc. 0,012
134002-023	● rosso/red	x1	10	450	440	500	300	1,62	mc. 0,012
134015-023	● blu/blue	x1	10	450	440	500	300	1,62	mc. 0,012
134007-023	● arancio/orange	x1	10	450	440	500	300	1,62	mc. 0,012
134005-023	● beige/beige	x1	10	450	440	500	300	1,62	mc. 0,012

20 pannello schienale da tappezzare
panel back for upholstery

code	finishing	q.kit	q.pack	a	b	kg.x1	vol.x1
132103-046	● nero/black	x1	20	390	310	0,50	mc. 0,004

21 pannello sedile da tappezzare
panel seat for upholstery

code	finishing	q.kit	q.pack	a	b	kg.x1	vol.x1
132203-046	● nero/black	x1	20	400	450	0,60	mc. 0,004

10 square-coppia braccioli in plastica
square-plastic pair arms

code	finishing	q.kit	q.pack	a	b	kg.x1	vol.x1
131703-005	● nero/black	x1	10	360	260	0,70	mc. 0,006
131704-005	● grigio/grey	x1	10	360	260	0,70	mc. 0,006

22 confezione viti tbl+ fr. d.5x14 per pannello da tappezzare
screws tbl+ fr.hilo d.5x14 zinc.black (to fix seat panel) package

code	finishing	q.kit	q.pack
117003-071	● nero/black	x4	200

27 doppia ruota 036 in pa (ricoperta pur)
pa twin wheel castor 036 (covered with pur)

code	finishing	q.kit
134403-001	● nero/black	x4

27 gambo godronato 08 zincato
zinc plated knured 08 stem

code	finishing	q.kit
117911-300	○ zincata/zinc	x4

14 **15** bracciolo destro/sinistro con gancio portavoiletta
right/left arm with attachment for tablet

code	finishing	q.kit	q.pack	kg.x1	vol.x1
131703-009	● nero/black	x1	20	0,70	mc. 0,006
131703-006	● nero/black	x1	20	0,70	mc. 0,006
131704-003	● grigio/grey	x1	20	0,70	mc. 0,006
131704-004	● grigio/grey	x1	20	0,70	mc. 0,006

main component sizes

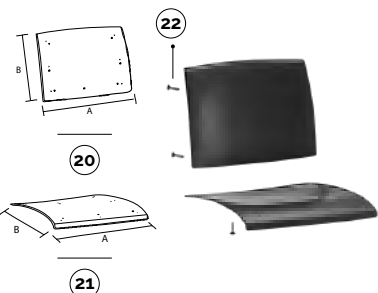
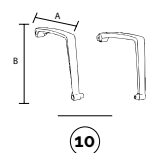
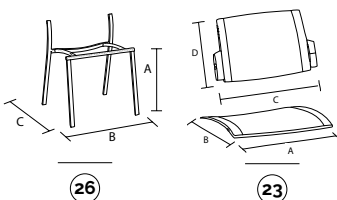

optionals



square

4-legs for castors/backrest and seat options

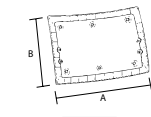

05

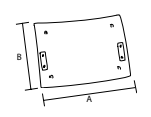

06

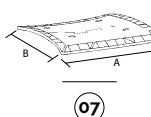

07

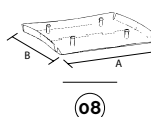

08

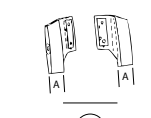

09



05 square-shi-schienale interno in plastica
square-shi-inner plastic back

code	finishing	q.kit	q.pack	a	b	kg.x1	vol.x1
132103-006	● nero/black	x1	20	440	290	0,55	mc. 0,004

06 square-she-schienale esterno in plastica
square-she-outer plastic back

code	finishing	q.kit	q.pack	a	b	kg.x1	vol.x1
132103-005	● nero/black	x1	20	425	280	0,37	mc. 0,004
132104-026	● grigio/grey	x1	20	425	280	0,37	mc. 0,004

07 square-sedile interno in plastica
square-inner plastic seat

code	finishing	q.kit	q.pack	a	b	kg.x1	vol.x1
132203-007	● nero/black	x1	20	440	460	0,90	mc. 0,005

08 square-sedile esterno in plastica
square-outer plastic seat

code	finishing	q.kit	q.pack	a	b	kg.x1	vol.x1
132203-006	● nero/black	x1	20	430	450	0,53	mc. 0,008
132204-026	● grigio/grey	x1	20	430	450	0,53	mc. 0,008

09 square-coppia supporti schienale in plastica
square-plastic pair of supports for back

code	finishing	q.kit	q.pack	a	kg.x1	vol.x1
134003-087	● nero/black	x1	40	25x15	0,16	mc. 0,0002
134004-022	● grigio/grey	x1	40	25x15	0,16	mc. 0,0002

and 11 12 04

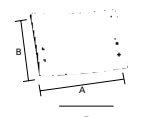

24

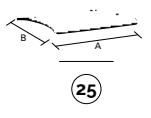

25



24 schienale in multistrato faggio + viti
back in plywood beech with screws

code	finishing	q.kit	q.pack	a	b	kg.x1
122107-010	● faggio/beech wood	x1	15	425	280	0,50

25 square sdlf-sedile multistrato faggio verniciato + viti
square sdlf-painted beech wood seat with screws

code	finishing	q.kit	q.pack	a	b	kg.x1
122207-015	● faggio/beech wood	x1	15	422	280	1,65

and 09 10 13

main component sizes

square

slide

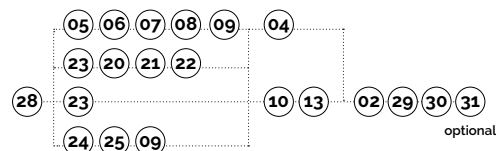

main component sizes

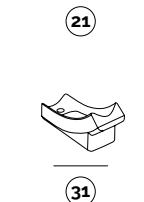
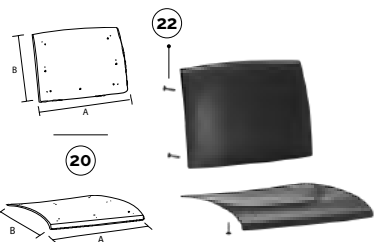
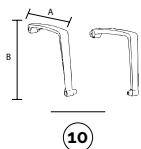
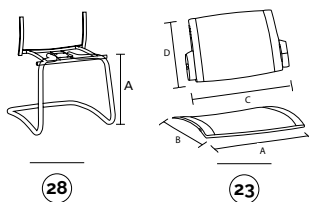

28 base slitta slide bases

code	finishing	q.kit	q.pack	a	kg.x1	vol.x1
110503-013	● nero/black	x1	80	450	6,50	mc. 0.03
110504-017	● grigio/grey	x1	80	450	6,50	mc. 0.03
110510-016	● cromato/chrome	x1	80	450	6,50	mc. 0.03

29 p2p pinza due pioli politene nera p2p two-pins plier in black polythene

code	finishing	q.kit
134003-003	● nero/black	x4

30 tappo copritesta alettato d.25 nero ribbed insert d.25 black

code	finishing	q.kit
134103-250	● nero/black	x2

31 piedino antiribaltamento in plastica nera plastic black feet anti-upsetting

code	finishing	q.kit	q.pack	kg.x1	vol.x1
134303-006	● nero/black	x2	100	0,025	mc. 0.0001

23 square-coppia sedile schienale in plastica colorato square-plastic seat/back coloured at sight

code	finishing	q.kit	q.pack	a	b	c	d	kg.x1	vol.x1
134003-088	● nero/black	x1	10	450	440	500	300	1,62	mc. 0.012
134004-023	● grigio/grey ral7040	x1	10	450	440	500	300	1,62	mc. 0.012
134002-023	● rosso/red ppl42	x1	10	450	440	500	300	1,62	mc. 0.012
134015-023	● blu/blue ral5002	x1	10	450	440	500	300	1,62	mc. 0.012
134007-023	● arancio/orange ppl22	x1	10	450	440	500	300	1,62	mc. 0.012
134005-023	● beige/beige ppl09	x1	10	450	440	500	300	1,62	mc. 0.012

20 pannello schienale da tappezzare panel back for upholstery

code	finishing	q.kit	q.pack	a	b	kg.x1	vol.x1
132103-046	● nero/black	x1	20	390	310	0,50	mc. 0.004

21 pannello sedile da tappezzare panel seat for upholstery

code	finishing	q.kit	q.pack	a	b	kg.x1	vol.x1
132203-046	● nero/black	x1	20	400	450	0,60	mc. 0.004

10 square-coppia braccioli in plastica square-plastic pair arms

code	finishing	q.kit	q.pack	a	b	kg.x1	vol.x1
131703-005	● nero/black	x1	10	360	260	0,70	mc. 0.006
131704-005	● grigio/grey	x1	10	360	260	0,70	mc. 0.006

22 confezione viti tbl+ fr. d.5x14 per pannello da tappezzare screws tbl+ fr.hilo d.5x14 zinc.black (to fix seat panel) package

code	finishing	q.kit	q.pack
117003-071	● nero/black	x4	200

02 puntale alettato rettangolare 25x15 ribbed rectangular insert 25x15

code	finishing	q.kit
134203-020	● nero/black	x2
134204-020	● grigio/grey	x2

04 tappo copritesta 022 per sedia senza braccioli cover head cap 022 for chair without arms

code	finishing	q.kit
134103-220	● nero/black	x2
134104-220	● grigio/grey	x2

square

slide/ backrest and seat options

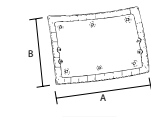

05

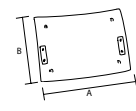

06

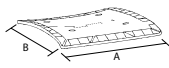

07

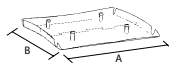

08



09



05 square-shi-schienale interno in plastica
square-shi-inner plastic back

code	finishing	q.kit	q.pack	a	b	kg.x1	vol.x1
132103-006	● nero/black	x1	20	440	290	0,55	mc. 0,004

06 square-she-schienale esterno in plastica
square-she-outer plastic back

code	finishing	q.kit	q.pack	a	b	kg.x1	vol.x1
132103-005	● nero/black	x1	20	425	280	0,37	mc. 0,004
132104-026	● grigio/grey	x1	20	425	280	0,37	mc. 0,004

07 square-sedile interno in plastica
square-inner plastic seat

code	finishing	q.kit	q.pack	a	b	kg.x1	vol.x1
132203-007	● nero/black	x1	20	440	460	0,90	mc. 0,005

08 square-sedile esterno in plastica
square-outer plastic seat

code	finishing	q.kit	q.pack	a	b	kg.x1	vol.x1
132203-006	● nero/black	x1	20	430	450	0,53	mc. 0,008
132204-026	● grigio/grey	x1	20	430	450	0,53	mc. 0,008

09 square-coppia supporti schienale in plastica
square-plastic pair of supports for back

code	finishing	q.kit	q.pack	a	kg.x1	vol.x1
134003-087	● nero/black	x1	40	25x15	0,16	mc. 0,0002
134004-022	● grigio/grey	x1	40	25x15	0,16	mc. 0,0002

and · **11** **12** **10** **13** **02**

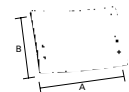

24

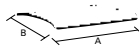

25



24 schienale in multistrato faggio + viti
back in plywood beech with screws

code	finishing	q.kit	q.pack	a	b	kg.x1
122107-010	● faggio/beech wood	x1	15	425	280	0,50

25 square sdlf-sedile multistrato faggio verniciato + viti
square sdlf-painted beech wood seat with screws

code	finishing	q.kit	q.pack	a	b	kg.x1
122207-015	● faggio/beech wood	x1	15	422	280	1,65

and · **09** **04** **02**

main component sizes

square

swivel

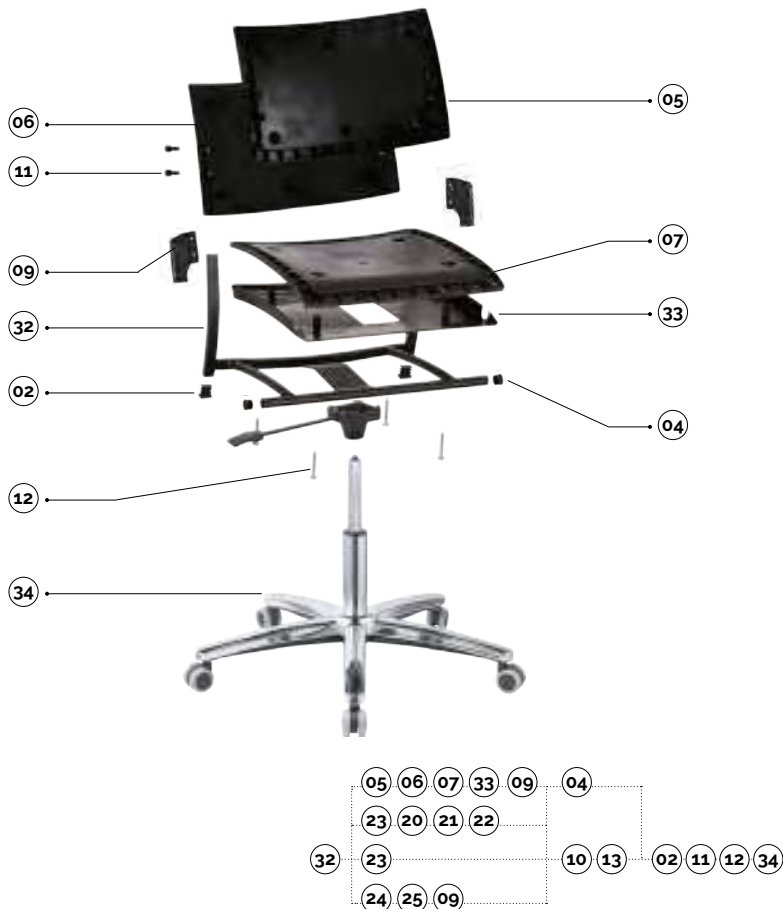

main component sizes

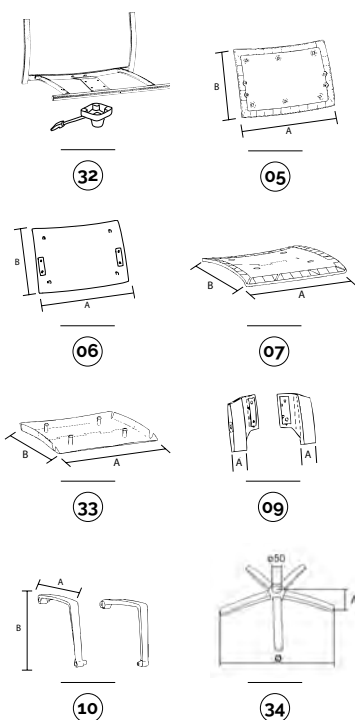

32 telaio girevole con blocchetto comando a gas
swivel frame gas with lever

code	finishing	q.kit	q.pack	kg.x1	vol.x1
112603-029	● nero/black	x1	100	3,50	mc. 0,05
112604-029	● grigio/grey	x1	100	3,50	mc. 0,05

02 puntale alettato rettangolare 25x15
ribbed rectangular insert 25x15

code	finishing	q.kit
134203-020	● nero/black	x2
134204-020	● grigio/grey	x2

04 tappo copritesta 022 per sedia senza braccioli
cover head cap 022 for chair without arms

code	finishing	q.kit
134103-220	● nero/black	x2
134104-220	● grigio/grey	x2

05 square-shi-schienale interno in plastica
square-shi-inner plastic back

code	finishing	q.kit	q.pack	a	b	kg.x1	vol.x1
132103-006	● nero/black	x1	20	440	290	0,55	mc. 0,004

06 square-she-schienale esterno in plastica
square-she-outer plastic back

code	finishing	q.kit	q.pack	a	b	kg.x1	vol.x1
132103-005	● nero/black	x1	20	425	280	0,37	mc. 0,004
132104-026	● grigio/grey	x1	20	425	280	0,37	mc. 0,004

07 square-sedile interno in plastica
square-inner plastic seat

code	finishing	q.kit	q.pack	a	b	kg.x1	vol.x1
132203-007	● nero/black	x1	20	440	460	0,90	mc. 0,005

33 square-sedile esterno in plastica
square-outer plastic seat

code	finishing	q.kit	q.pack	a	b	kg.x1	vol.x1
132203-008	● nero/black	x1	20	430	450	0,53	mc. 0,008
132204-027	● grigio/grey	x1	20	430	450	0,53	mc. 0,008

09 square-coppia supporti schienale in plastica
square-plastic pair of supports for back

code	finishing	q.kit	q.pack	a	kg.x1	vol.x1
134003-087	● nero/black	x1	40	25x15	0,16	mc. 0,0002
134004-022	● grigio/grey	x1	40	25x15	0,16	mc. 0,0002

10 square-coppia braccioli in plastica
square-plastic pair arms

code	finishing	q.kit	q.pack	a	b	kg.x1	vol.x1
131703-005	● nero/black	x1	10	360	260	0,70	mc. 0,006
131704-005	● grigio/grey	x1	10	360	260	0,70	mc. 0,006

11 vite testa cilindrica a croce m6x16 zincata
screw cylindrical cross head m6x16 zinc

code	finishing	q.kit
117711-191	○ zincata/zinc	x4

12 vite testa svasata a croce m6x30 zincata (vite per fissaggio sedile)
screw flared head m6x30 zinc (screw for six seat)

code	finishing	q.kit
117711-192	○ zincata/zinc	x4

34 b40 base in metallo d.640 con coprisaldatura
b40 metal base d.640 with cover welding

code	finishing	q.kit	q.pack	a	o	kg.x1	vol.x1
110210-027	● cromato/chrome	x1	5	60	640	2,85	mc. 0,014

square

swivel/backrest and seat options

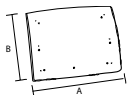

20

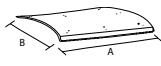

21



23



23 square-coppia sedile schienale in plastica colorato square-plastic seat/back coloured at sight

code	finishing	q.kit	q.pack	a	b	c	d	kg.x1	vol.x1
134003-088	● nero/black	x1	10	450	440	500	300	1.62	mc. 0,012
134004-023	● grigio/grey RAL7040	x1	10	450	440	500	300	1.62	mc. 0,012
134002-023	● rosso/red PPL42	x1	10	450	440	500	300	1.62	mc. 0,012
134015-023	● blu/blue RAL5002	x1	10	450	440	500	300	1.62	mc. 0,012
134007-023	● arancio/orange PPL22	x1	10	450	440	500	300	1.62	mc. 0,012
134005-023	● beige/beige PPL09	x1	10	450	440	500	300	1.62	mc. 0,012

20 pannello schienale da tappezzare panel back for upholstery

code	finishing	q.kit	q.pack	a	b	kg.x1	vol.x1
132103-046	● nero/black	x1	20	390	310	0,50	mc. 0,004

21 pannello sedile da tappezzare panel seat for upholstery

code	finishing	q.kit	q.pack	a	b	kg.x1	vol.x1
132203-046	● nero/black	x1	20	400	450	0,60	mc. 0,004

22 confezione viti tbl+ fr. d.5x14 per pannello da tappezzare screws tbl+ fr.hilo d.5x14 zinc.black (to fix seat panel) package

code	finishing	q.kit	q.pack
117003-071	● nero/black	x4	200

and - 04 02

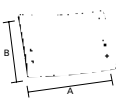

24

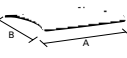

25



24 schienale in multistrato faggio + viti back in plywood beech with screws

code	finishing	q.kit	q.pack	a	b	kg.x1
122107-010	● faggio/beech wood	x1	15	425	280	0,50

25 square sdlf-sedile multistrato faggio verniciato + viti square sdlf-painted beech wood seat with screws

code	finishing	q.kit	q.pack	a	b	kg.x1
122207-015	● faggio/beech wood	x1	15	422	280	1,65

and - 09 04 02

square bench

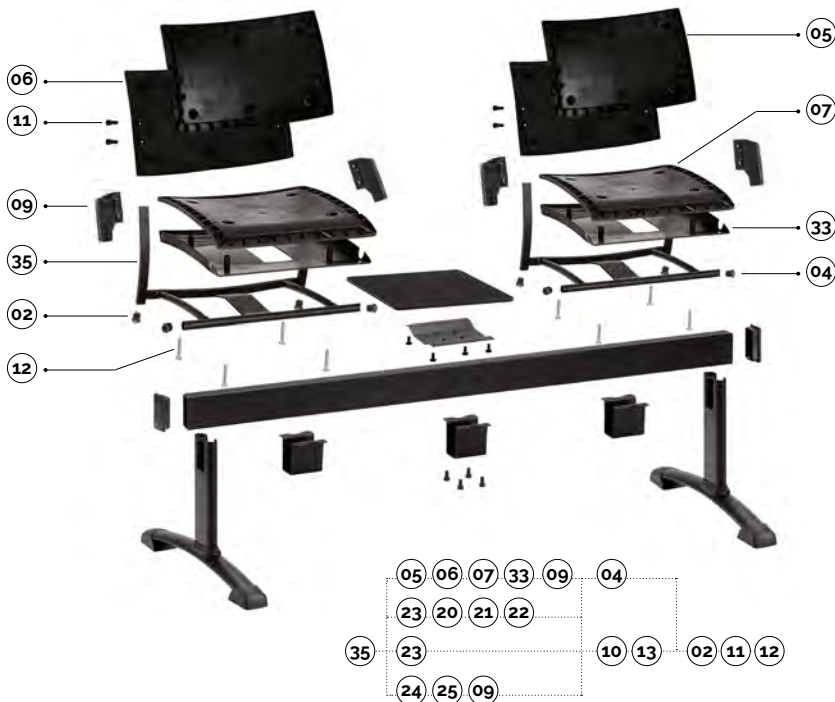

main component sizes

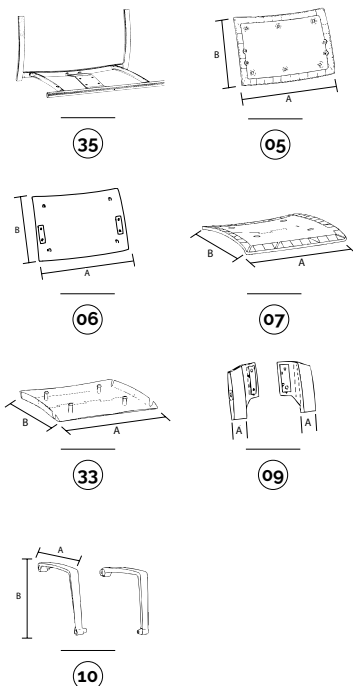

35 square.p telaio per panca tappi esclusi square.p bench frame caps excluded

code	finishing	q.kit	q.pack	kg.x1	vol.x1
110703-050	● nero/black	x1	100	2.80	mc. 0.020
110704-063	● grigio/grey	x1	100	2.80	mc. 0.020

02 puntale alettato rettangolare 25x15 ribbed rectangular insert 25x15

code	finishing	q.kit
134203-020	● nero/black	x2
134204-020	● grigio/grey	x2

04 tappo copritesta ø22 per sedia senza braccioli cover head cap ø22 for chair without arms

code	finishing	q.kit
134103-220	● nero/black	x2
134104-220	● grigio/grey	x2

05 square-shi-schienale interno in plastica square-shi-inner plastic back

code	finishing	q.kit	q.pack	a	b	kg.x1	vol.x1
132103-006	● nero/black	x1	20	440	290	0.55	mc. 0.004

06 square-she-schienale esterno in plastica square-she-outer plastic back

code	finishing	q.kit	q.pack	a	b	kg.x1	vol.x1
132103-005	● nero/black	x1	20	425	280	0.37	mc. 0.004
132104-026	● grigio/grey	x1	20	425	280	0.37	mc. 0.004

07 square-sedile interno in plastica square-inner plastic seat

code	finishing	q.kit	q.pack	a	b	kg.x1	vol.x1
132203-007	● nero/black	x1	20	440	460	0.90	mc. 0.005

33 square-sedile esterno in plastica square-outer plastic seat

code	finishing	q.kit	q.pack	a	b	kg.x1	vol.x1
132203-008	● nero/black	x1	20	430	450	0.53	mc. 0.008
132204-027	● grigio/grey	x1	20	430	450	0.53	mc. 0.008

09 square-coppia supporti schienale in plastica square-plastic pair of supports for back

code	finishing	q.kit	q.pack	a	kg.x1	vol.x1
134003-087	● nero/black	x1	40	25x15	0.16	mc. 0.0002
134004-022	● grigio/grey	x1	40	25x15	0.16	mc. 0.0002

10 square-coppia braccioli in plastica square-plastic pair arms

code	finishing	q.kit	q.pack	a	b	kg.x1	vol.x1
131703-005	● nero/black	x1	10	360	260	0.70	mc. 0.006
131704-005	● grigio/grey	x1	10	360	260	0.70	mc. 0.006

11 vite testa cilindrica a croce m6x16 zincata screw cylindrical cross head m6x16 zinc

code	finishing	q.kit
117711-191	○ zincata/zinc	x4

12 vite testa svasata a croce m6x30 zincata (vite per fissaggio sedile) screw flared head m6x30 zinc (screw for six seat)

code	finishing	q.kit
117711-192	○ zincata/zinc	x4

for the bench components, see page 417

OPTIONAL
bench connector
E-USB
bench plug



JIM
bench leg



plastic

90GM
bench leg



90GF
bench leg



91GM **NEW**
bench leg



100GM
bench leg



200GM
bench leg



PIONEER
bench arm



CUT
bench leg



SLIM
bench leg



CUT
bench arm



SLIM
bench arm



metal

aluminium

square

bench/backrest and seat options

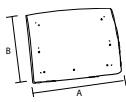

20



21

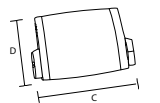

23



23 square-coppia sedile schienale in plastica colorato square-plastic seat/back coloured at sight

code	finishing	q.kit	q.pack	a	b	c	d	kg.x1	vol.x1
134003-088	● nero/black	x1	10	450	440	500	300	1.62	mc. 0,012
134004-023	● grigio/grey RAL7040	x1	10	450	440	500	300	1.62	mc. 0,012
134002-023	● rosso/red PPL42	x1	10	450	440	500	300	1.62	mc. 0,012
134015-023	● blu/blue RAL5002	x1	10	450	440	500	300	1.62	mc. 0,012
134007-023	● arancio/orange PPL22	x1	10	450	440	500	300	1.62	mc. 0,012
134005-023	● beige/beige PPL09	x1	10	450	440	500	300	1.62	mc. 0,012

20 pannello schienale da tappezzare panel back for upholstery

code	finishing	q.kit	q.pack	a	b	kg.x1	vol.x1
132103-046	● nero/black	x1	20	390	310	0,50	mc. 0,004

21 pannello sedile da tappezzare panel seat for upholstery

code	finishing	q.kit	q.pack	a	b	kg.x1	vol.x1
132203-046	● nero/black	x1	20	400	450	0,60	mc. 0,004

22 confezione viti tbl+ fr. d.5x14 per pannello da tappezzare screws tbl+ fr.hilo d.5x14 zinc.black (to fix seat panel) package

code	finishing	q.kit	q.pack
117003-071	● nero/black	x4	200

and · 04 02

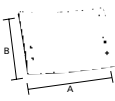

24



25



24 schienale in multistrato faggio back in plywood beech

code	finishing	q.kit	q.pack	a	b	kg.x1
122107-010	● faggio/beech wood	x1	15	425	280	0,50

25 square sdlf-sedile multistrato faggio verniciato + viti square sdlf-painted beech wood seat with screws

code	finishing	q.kit	q.pack	a	b	kg.x1
122207-015	● faggio/beech wood	x1	15	422	280	1,65

and · 09 04 02



logan



discover more about
Logan Collection

La seduta certificata CATAS e BIFMA. Estremamente versatile grazie allo schienale disponibile in plastica pieno o traforato, o da tappezzare o ancora in rete, che le conferisce un design distintivo. È abbinabile a tutti i telai disponibili in assortimento: opzionabili i braccioli in plastica con o senza aggancio porta tavoletta e gli agganci laterali.

Logan garantisce una linea ricca e completa.

Logan è ideale per gli ambienti Office e Community.

CATAS and BIFMA certified chair.

Offers extreme versatility thanks to the backrest available in solid or perforated plastic, either to be upholstered or in mesh, lending it a distinctive design. It can be combined with all the frames available in our range; optional plastic armrests, with or without writing tablet holder and lateral hooks.

Logan offers a complete and highly versatile line.

Logan is ideal for Office and Community environments.

Plus

- Certificazione ANSI/BIFMA X5.1.
- Grande versatilità grazie al comodo schienale disponibile in tante alternative.
- Linea funzionale e completa.
- *ANSI/BIFMA X5.1 Certification.*
- *Great versatility thanks to the comfortable backrest available in a range of alternatives.*
- *A functional and complete line.*



**trolley
available**



**certified
product**

logan

slide

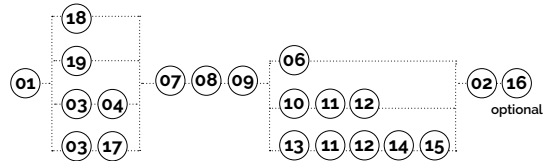
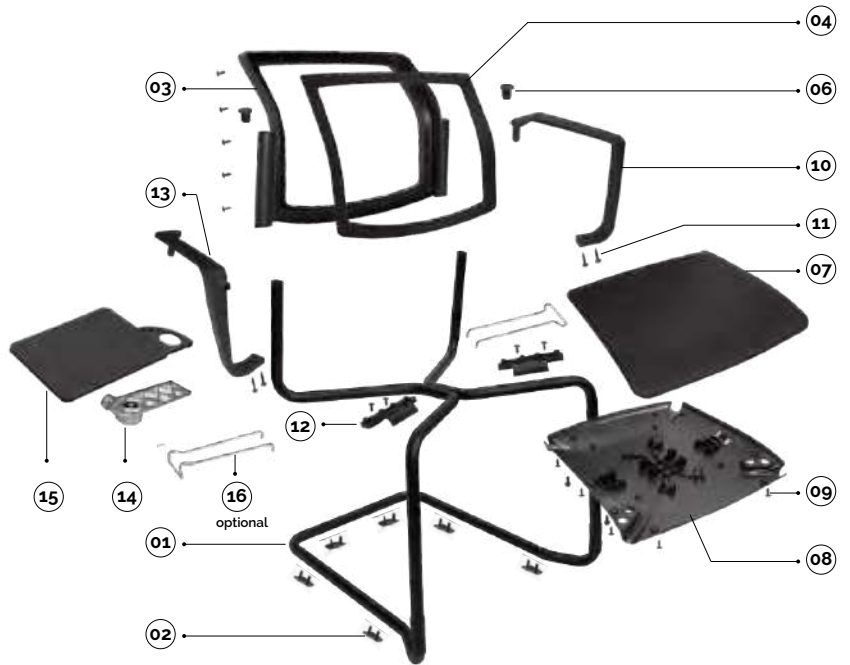

plastic colours

- nero/black
- grigio/gray ral 7040
- bianco/white ral 9003
- blu/blue ral 5014

main component sizes

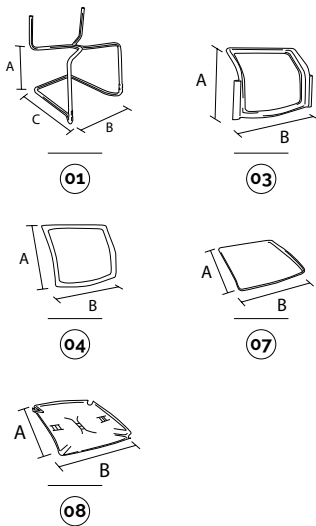

optionals

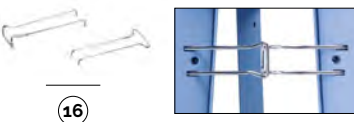

01 logan-base a slitta in tubo asform d.22 tappi esclusi

logan-slide frame asform pipe d.22 without caps

code	finishing	q.kit	q.pack	a	b	c	kg.x1	vol.x1
110503-059	● nero/black	x1	50	450	550	550	4,70	mc. 0,06
110504-059	● grigio/grey ig2621	x1	50	450	550	550	4,70	mc. 0,06
110510-059	● cromato/chrome	x1	50	450	550	550	4,70	mc. 0,06

02 p2p-pinza due pioli in polietilene nera

p2p -two pins pliers in black polythene

code	finishing	q.kit
134003-003	● nero/black	x6

03 logan-telaio schienale in plastica portante

logan-outer back frame in plastic

code	finishing	q.kit	q.pack	a	b	kg.x1	vol.x1
132103-084	● nero/black	x1	10	390	500	0,58	mc. 0,088

04 logan-cornice schienale in plastica per rete

logan-open frame in plastic for mesh

code	finishing	q.kit	q.pack	a	b	kg.x1	vol.x1
132103-085	● nero/black	x1	20	380	420	0,30	mc. 0,005

06 logan-tappo per telaio e schienale

inner caps-cover head d.22

code	finishing	q.kit	q.pack	kg.x1	vol.x1
131703-029	● nero/black	x2	20	0,025	mc. 0,001

07 logan-sedile in plastica colorato a vista

logan-plastic seat coloured at sight

code	finishing	q.kit	q.pack	a	b	kg.x1	vol.x1
132203-082	● nero/black	x1	10	430	460	0,86	mc. 0,01

08 logan-sottosedile in plastica per telaio 4 gambe e slitta

logan-outer plastic seat for four legs and slide

code	finishing	q.kit	q.pack	a	b	kg.x1	vol.x1
132203-080	● nero/black	x1	20	420	450	0,51	mc. 0,007

09 logan-sacchetto con viti + pf1 per 10 sedie - per sedile e schienale portante

logan-screws + pf1 for 10 chairs for seat and outer backrest

code	finishing	q.kit	q.pack
117000-022	● nero/black	x0.1	1

16 logan-coppia agganci laterali maschio + femmina cromati

logan-chrome lateral hooks male + female

code	finishing	q.kit	q.pack	kg.x1	vol.x1
113410-100	● cromato/chrome	x1	100	0,13	mc. 0,0004

logan

slide/tablet accessories

main component sizes



13



11

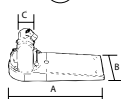

12

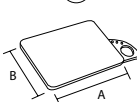

14



15

13 logan-coppia braccioli con aggancio portatavoletta in plastica logan-pair of plastic arms right/left with writing tablet hook

code	finishing	q.kit	q.pack	kg.x1	vol.x1
131703-032	● nero/black	x1	10	left + right writing tablet hook	0.49 mc. 0.051
131703-033	● nero/black	x1	10	right + left writing tablet hook	0.49 mc. 0.051

11 logan-kit viti per 10 coppie braccioli logan-kit screws for 10 pair arms

code	finishing	q.kit	q.pack	kg.x1	vol.x1
117000-025	● nero/black	x0.1	1		

12 logan-piastra di fissaggio per bracciolo logan-fixing plate for arm

code	finishing	q.kit	q.pack	kg.x1	vol.x1
131703-034	● nero/black	x2	50	0.07	mc. 0.0013

14 spta-snodo tavoletta antipanico in alluminio lucido spta-polished aluminium swivel safety mechanism for tablet

code	finishing	q.kit	q.pack	a	b	c	kg.x1	vol.x1
111701-900	● alluminio/aluminium destro/right	x1	10	180	66	15x15	0.365	mc. 0.001
111701-901	● alluminio/aluminium sinistro/left	x1	10	180	66	15x15	0.365	mc. 0.001

15 tlt3-tavoletta ambidestro con portabicchiere e portapenne tlt3--writing tablet with cup holder and pen tray

code	finishing	q.kit	q.pack	a	b	kg.x1	vol.x1
134003-041	● nero/black	x1	10	410	300	1.05	mc. 0.036

TLT tablet TLT2 tablet TLT3 tablet BEAN tablet TL02 tablet SPT2 mechanism tablet SPTA mechanism antipanic



for writing tablet options, see page 404/405

slide/options

main component sizes

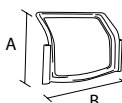

03

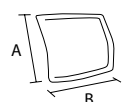

17



10



03 logan-telaio schienale in plastica portante logan-outer back frame in plastic

code	finishing	q.kit	q.pack	a	b	kg.x1	vol.x1
132103-084	● nero/black	x1	10	390	500	0.58	mc. 0.088

17 logan-pannello schienale in plastica da tappezzeria logan-plastic panel back for upholstery

code	finishing	q.kit	q.pack	a	b	kg.x1	vol.x1
132103-086	● nero/black	x1	20	380	420	0.90	mc. 0.005

10 logan-coppia braccioli dx/sx in plastica logan-pair of plastic arms right/left

code	finishing	q.kit	q.pack	kg.x1	vol.x1
131703-031	● nero/black	x1	10	0.43	mc. 0.051

and · 11 12 07 08 09

main component sizes

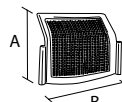

18

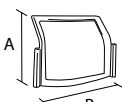

19



18 logan-schienale traforato in plastica colorato a vista logan-perforated plastic back coloured at sight

code	finishing	q.kit	q.pack	a	b	kg.x1	vol.x1
132103-083	● nero/black	x1	10	390	500	0.82	mc. 0.088

19 logan-schienale pieno in plastica colorato a vista logan-full plastic back coloured at sight

code	finishing	q.kit	q.pack	a	b	kg.x1	vol.x1
132103-089	● nero/black	x1	10	390	500	0.82	mc. 0.088

and · 06 07 08 09



for all colour codes, see page 227

logan

4-legs



CERTIFIED BY
BIFMA



logon-carrello portasedie con accessori
logon-trolley for chairs with accessories

code	finishing	q.kit
110803-344	● nero/black	x1

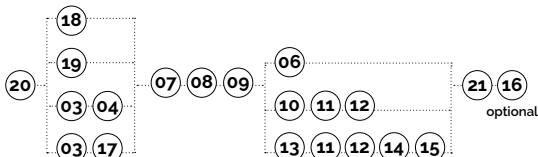

plastic colours

- nero/black
- grigio/gray ral 7040
- bianco/white ral 9003
- blu/blue ral 5014

main component sizes

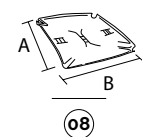
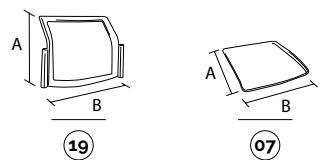
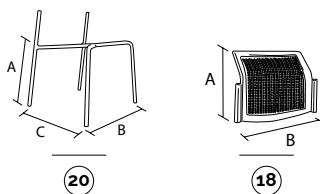

optionals

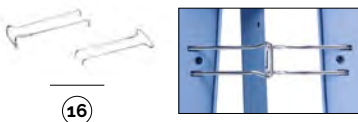

20 logon-telaio 4 gambe in tubo d.22 senza tappi logon-fixed four legs frame d.22 without caps

code	finishing	q.kit	q.pack	a	b	c	kg.x1	vol.x1
110603-059	● nero/black	x1	72	440	530	510	2,70	mc. 0,017
110604-059	● grigio/grey ig2621	x1	72	440	530	510	2,70	mc. 0,017
110610-059	● cromato/chrome	x1	72	440	530	510	2,70	mc. 0,017

21 confezione puntali tondi d.22 neri black inner round flat caps d.22 package

code	finishing	q.kit	q.pack
137003-073	● nero/black	x4	200

18 logon-schienale traforato in plastica colorato a vista logon-perforated plastic back coloured at sight

code	finishing	q.kit	q.pack	a	b	kg.x1	vol.x1
132103-083	● nero/black	x1	10	390	500	0,82	mc. 0,088

19 logon-schienale pieno in plastica colorato a vista logon-full plastic back coloured at sight

code	finishing	q.kit	q.pack	a	b	kg.x1	vol.x1
132103-089	● nero/black	x1	10	390	500	0,82	mc. 0,088

06 logon-tappo per telaio e schienale inner caps-cover head d.22

code	finishing	q.kit	q.pack	kg.x1	vol.x1
131703-029	● nero/black	x2	20	0,025	mc. 0,001

07 logon-sedile in plastica colorato a vista logon-plastic seat coloured at sight

code	finishing	q.kit	q.pack	a	b	kg.x1	vol.x1
132203-082	● nero/black	x1	10	430	460	0,86	mc. 0,01

08 logon-sottosedile in plastica per telaio 4 gambe e slitta logon-outer plastic seat for four legs and slide

code	finishing	q.kit	q.pack	a	b	kg.x1	vol.x1
132203-080	● nero/black	x1	20	420	450	0,51	mc. 0,007

09 logon-sacchetto con viti + pf1 per 10 sedie - per sedile e schienale portante logon-screws + pf1 for 10 chairs for seat and outer backrest

code	finishing	q.kit	q.pack
117000-022	● nero/black	x0.1	1

16 logon-coppia agganci laterali maschio + femmina cromati logon-chrome lateral hooks male + female

code	finishing	q.kit	q.pack	kg.x1	vol.x1
113410-100	● cromato/chrome	x1	100	0,13	mc. 0,0004

logan

4-legs/tablet accessories

main component sizes

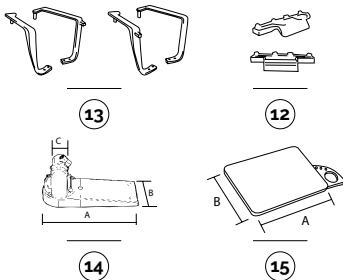

13 logan-coppia braccioli con aggancio portatavoletta in plastica

logan-pair of plastic arms right/left with writing tablet hook

code	finishing	q.kit	q.pack	kg.x1	vol.x1
131703-032	● nero/black	x1	10	left + right writing tablet hook	0.49 mc. 0.051
131703-033	● nero/black	x1	10	right + left writing tablet hook	0.49 mc. 0.051

11 logan-kit viti per 10 coppie braccioli

logan-kit screws for 10 pair arms

code	finishing	q.kit	q.pack	kg.x1	vol.x1
117000-025	● nero/black	x0.1	1		

12 logan-piastra di fissaggio per bracciolo

logan-fixing plate for arm

code	finishing	q.kit	q.pack	kg.x1	vol.x1
131703-034	● nero/black	x2	50	0.07	mc. 0.0013

14 spta-snodo tavoletta antipanico in alluminio lucido

spta-polished aluminium swivel safety mechanism for tablet

code	finishing	q.kit	q.pack	a	b	c	kg.x1	vol.x1
111701-900	● alluminio/aluminium destro/right	x1	10	180	66	15x15	0.365	mc. 0.001
111701-901	● alluminio/aluminium sinistro/left	x1	10	180	66	15x15	0.365	mc. 0.001

15 tlt3-tavoletta ambidestro con portabicchiere e portapenne

tlt3--writing tablet with cup holder and pen tray

code	finishing	q.kit	q.pack	a	b	kg.x1	vol.x1
134003-041	● nero/black	x1	10	410	300	1.05	mc. 0.036

TLT tablet TLT2 tablet TLT3 tablet BEAN tablet TL02 tablet SPT2 mechanism tablet SPTA mechanism antipanic



for writing tablet options, see page 404/405

4-legs/options

main component sizes

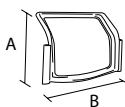

03

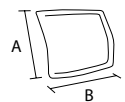

17



10



03 logan-telaio schienale in plastica portante

logan-outer back frame in plastic

code	finishing	q.kit	q.pack	a	b	kg.x1	vol.x1
132103-084	● nero/black	x1	10	390	500	0.58	mc. 0.088

17 logan-pannello schienale in plastica da tappezzare

logan-plastic panel back for upholstery

code	finishing	q.kit	q.pack	a	b	kg.x1	vol.x1
132103-086	● nero/black	x1	20	380	420	0.90	mc. 0.005

10 logan-coppia braccioli dx/sx in plastica

logan-pair of plastic arms right/left

code	finishing	q.kit	q.pack	kg.x1	vol.x1
131703-031	● nero/black	x1	10	0.43	mc. 0.051

and · 11 12 07 08 09

main component sizes

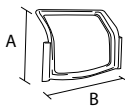

03

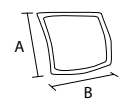

04



03 logan-telaio schienale in plastica portante

logan-outer back frame in plastic

code	finishing	q.kit	q.pack	a	b	kg.x1	vol.x1
132103-084	● nero/black	x1	10	390	500	0.58	mc. 0.088

04 logan-cornice schienale in plastica per rete

logan-open frame in plastic for mesh

code	finishing	q.kit	q.pack	a	b	kg.x1	vol.x1
132103-085	● nero/black	x1	20	380	420	0.30	mc. 0.005

and · 10 11 12 07 08 09



for all colour codes, see page 227

logan

4-legs for castors



plastic colours

- nero/black
- grigio/gray ral 7040
- bianco/white ral 9003
- blu/blue ral 5014

logan-carrello portasedie con accessori
logan-trolley for chairs with accessories

code	finishing	q.kit
110803-344	● nero/black	x1

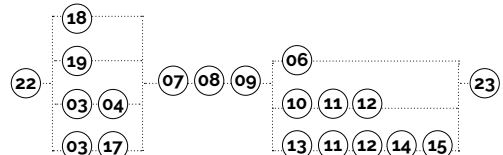

main component sizes

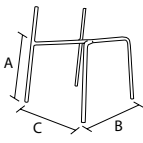

22

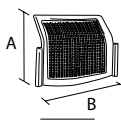

18

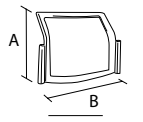

19

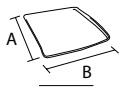

07

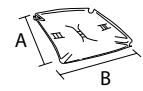

08

22 logan-telaio 4 gambe predisposto per 4 ruote + 4 tappi porta ruote
logan-fixed four legs frame issued for 4 wheels + 4 inner black caps for castors

code	finishing	q.kit	q.pack	a	b	c	kg.x1	vol.x1
110603-058	● nero/black	x1	80	440	470	510	2,70	mc. 0,017
110604-058	● grigio/grey ig2621	x1	80	440	470	510	2,70	mc. 0,017
110610-058	● cromato/chrome	x1	80	440	470	510	2,70	mc. 0,017

23 doppia ruota d.50 in desmopan con perno montato
twin wheel castor d.50 desmopan with pivot mounted

code	finishing	q.kit
134403-003	● nero/black	x4

18 logan-schienale traforato in plastica colorato a vista
logan-perforated plastic back coloured at sight

code	finishing	q.kit	q.pack	a	b	kg.x1	vol.x1
132103-083	● nero/black	x1	10	390	500	0,82	mc. 0,088

19 logan-schienale pieno in plastica colorato a vista
logan-full plastic back coloured at sight

code	finishing	q.kit	q.pack	a	b	kg.x1	vol.x1
132103-089	● nero/black	x1	10	390	500	0,82	mc. 0,088

06 logan-tappo per telaio e schienale
inner caps-cover head d.22

code	finishing	q.kit	q.pack	kg.x1	vol.x1
131703-029	● nero/black	x2	20	0,025	mc. 0,001

07 logan-sedile in plastica colorato a vista
logan-plastic seat coloured at sight

code	finishing	q.kit	q.pack	a	b	kg.x1	vol.x1
132203-082	● nero/black	x1	10	430	460	0,86	mc. 0,01

08 logan-sottosedile in plastica per telaio 4 gambe e slitta
logan-outer plastic seat for four legs and slide

code	finishing	q.kit	q.pack	a	b	kg.x1	vol.x1
132203-080	● nero/black	x1	20	420	450	0,51	mc. 0,007

09 logan-sacchetto con viti + pf1 per 10 sedie - per sedile e schienale portante
logan-screws + pf1 for 10 chairs for seat and outer backrest

code	finishing	q.kit	q.pack
117000-022	● nero/black	x0,1	1

logan

4-legs for castors/tablet accessories

main component sizes

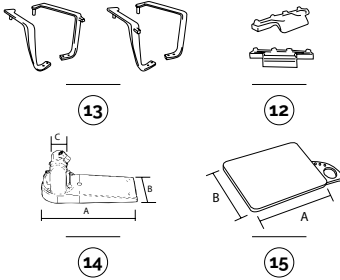

13 logan-coppia braccioli con aggancio portatavoletta in plastica

logan-pair of plastic arms right/left with writing tablet hook

code	finishing	q.kit	q.pack	kg.x1	vol.x1
131703-032	● nero/black	x1	10	left + right writing tablet hook	0.49 mc. 0.051
131703-033	● nero/black	x1	10	right + left writing tablet hook	0.49 mc. 0.051

11 logan-kit viti per 10 coppie braccioli

logan-kit screws for 10 pair arms

code	finishing	q.kit	q.pack	kg.x1	vol.x1
117000-025	● nero/black	x0.1	1		

12 logan-piastra di fissaggio per bracciolo

logan-fixing plate for arm

code	finishing	q.kit	q.pack	kg.x1	vol.x1
131703-034	● nero/black	x2	50	0.07	mc. 0.0013

14 spta-snodo tavoletta antipanico in alluminio lucido

spta-polished aluminium swivel safety mechanism for tablet

code	finishing	q.kit	q.pack	a	b	c	kg.x1	vol.x1
111701-900	● alluminio/aluminium destro/right	x1	10	180	66	15x15	0.365	mc. 0.001
111701-901	● alluminio/aluminium sinistro/left	x1	10	180	66	15x15	0.365	mc. 0.001

15 tlt3-tavoletta ambidestro con portabicchiere e portapenne

tlt3--writing tablet with cup holder and pen tray

code	finishing	q.kit	q.pack	a	b	kg.x1	vol.x1
134003-041	● nero/black	x1	10	410	300	1.05	mc. 0.036

TLT tablet TLT2 tablet TLT3 tablet BEAN tablet TL02 tablet SPT2 mechanism tablet SPTA mechanism antipanic



for writing tablet options, see page 404/405

4-legs for castors/options

main component sizes

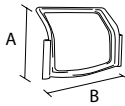

03

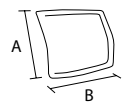

17



10



03 logan-telaio schienale in plastica portante

logan-outer back frame in plastic

code	finishing	q.kit	q.pack	a	b	kg.x1	vol.x1
132103-084	● nero/black	x1	10	390	500	0.58	mc. 0.088

17 logan-pannello schienale in plastica da tappezzare

logan-plastic panel back for upholstery

code	finishing	q.kit	q.pack	a	b	kg.x1	vol.x1
132103-086	● nero/black	x1	20	380	420	0.90	mc. 0.005

10 logan-coppia braccioli dx/sx in plastica

logan-pair of plastic arms right/left

code	finishing	q.kit	q.pack	kg.x1	vol.x1
131703-031	● nero/black	x1	10	0.43	mc. 0.051

and 11 12 07 08 09

main component sizes

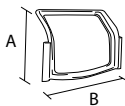

03

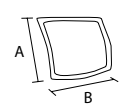

04



03 logan-telaio schienale in plastica portante

logan-outer back frame in plastic

code	finishing	q.kit	q.pack	a	b	kg.x1	vol.x1
132103-084	● nero/black	x1	10	390	500	0.58	mc. 0.088

04 logan-cornice schienale in plastica per rete

logan-open frame in plastic for mesh

code	finishing	q.kit	q.pack	a	b	kg.x1	vol.x1
132103-085	● nero/black	x1	20	380	420	0.30	mc. 0.005

and 10 11 12 07 08 09



for all colour codes, see page 227

logan

swivel

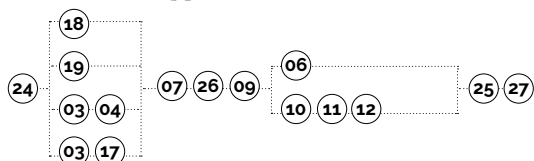
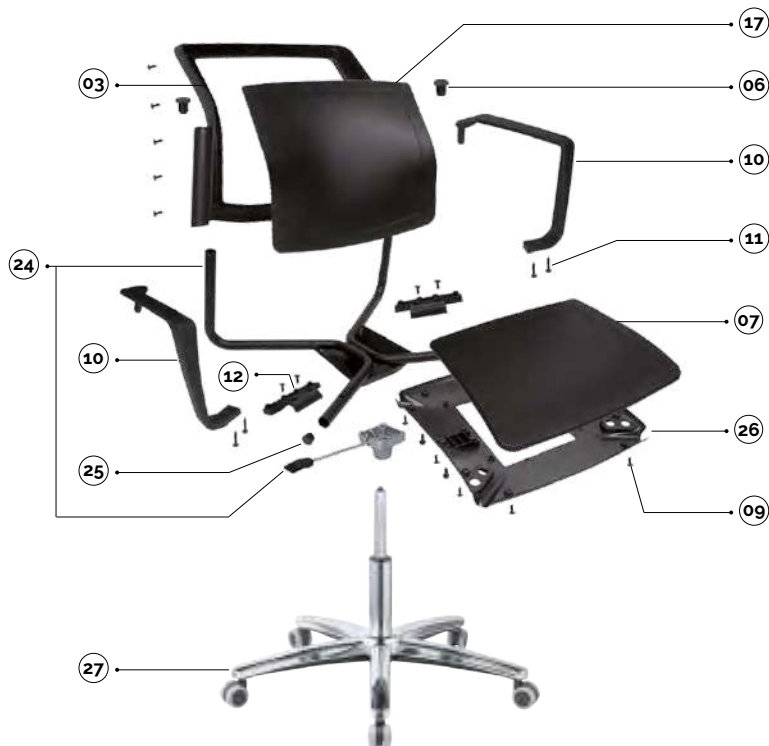

plastic colours

- nero/black
- grigio/gray ral 7040
- bianco/white ral 9003
- blu/blue ral 5014

main component sizes

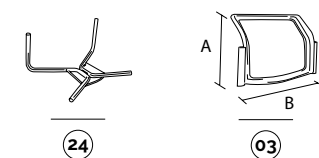

24

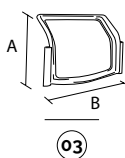

03

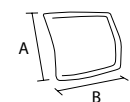

17

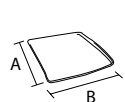

07

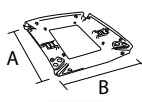

26



10



12



27

24 logan-telaio per girevole comando a gas senza tappi
logan-swivel frame with gas lever without caps

code	finishing	q.kit	q.pack	kg.x1	vol.x1
110903-024	● nero/black	x1	100	2,55	mc. 0,046

25 tc22-tappo copritesta alettato d.22 nero
tc22-inner caps-cover head d.22 black

code	finishing	q.kit
134103-220	● nero/black	x2

03 logan-telaio schienale in plastica portante
logan-outer back frame in plastic

code	finishing	q.kit	q.pack	a	b	kg.x1	vol.x1
132103-084	● nero/black	x1	10	390	500	0,58	mc. 0,088

17 logan-pannello schienale in plastica da tappezzare
logan-plastic panel back for upholstery

code	finishing	q.kit	q.pack	a	b	kg.x1	vol.x1
132103-086	● nero/black	x1	20	380	420	0,90	mc. 0,005

07 logan-sedile in plastica colorato a vista
logan-plastic seat coloured at sight

code	finishing	q.kit	q.pack	a	b	kg.x1	vol.x1
132203-082	● nero/black	x1	10	430	460	0,86	mc. 0,01

26 logan-sottosedile esterno in plastica per telaio panca e girevole
logan-outer plastic seat for swivel and bench

code	finishing	q.kit	q.pack	a	b	kg.x1	vol.x1
132203-081	● nero/black	x1	20	420	450	0,47	mc. 0,007

09 logan-sacchetto con viti + pf1 per 10 sedie - per sedile e schienale portante
logan-screws + pf1 for 10 chairs for seat and outer backrest

code	finishing	q.kit	q.pack
117000-022	● nero/black	x0.1	1

10 logan-coppia braccioli dx/sx in plastica
logan-pair of plastic arms right/left

code	finishing	q.kit	q.pack	kg.x1	vol.x1
131703-031	● nero/black	x1	10	0,43	mc. 0,051

11 logan-kit viti per 10 coppie braccioli
logan-kit screws for 10 pair arms

code	finishing	q.kit	q.pack
117000-025	● nero/black	x0.1	1

12 logan-piastra di fissaggio per bracciolo
logan-fixing plate for arm

code	finishing	q.kit	q.pack	kg.x1	vol.x1
131703-034	● nero/black	x2	50	0,07	mc. 0,0013

27 b40 base in metallo d.640 con coprisaldatura
b40 metal base d.640 with cover welding

code	finishing	q.kit	q.pack	a	o	kg.x1	vol.x1
110210-027	● cromato/chrome	x1	5	60	640	2,85	mc. 0,014

logan

swivel/options

main component sizes

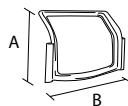

03

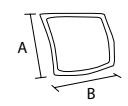

04



03 logan-telaio schienale in plastica portante
logan-outer back frame in plastic

code	finishing	q.kit	q.pack	a	b	kg.x1	vol.x1
132103-084	● nero/black	x1	10	390	500	0,58	mc. 0,088

04 logan-cornice schienale in plastica per rete
logan-open frame in plastic for mesh

code	finishing	q.kit	q.pack	a	b	kg.x1	vol.x1
132103-085	● nero/black	x1	20	380	420	0,30	mc. 0,005

and **10 11 12 07 26 09**

main component sizes

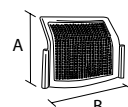

18

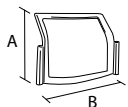

19



18 logan-schienale traforato in plastica colorato a vista
logan-perforated plastic back coloured at sight

code	finishing	q.kit	q.pack	a	b	kg.x1	vol.x1
132103-083	● nero/black	x1	10	390	500	0,82	mc. 0,088

19 logan-schienale pieno in plastica colorato a vista
logan-full plastic back coloured at sight

code	finishing	q.kit	q.pack	a	b	kg.x1	vol.x1
132103-089	● nero/black	x1	10	390	500	0,82	mc. 0,088

and **10 11 12 07 26 09**



for all colour codes, see page 227

logan

bench



plastic colours

- nero/black
- grigio/gray ral 7040
- bianco/white ral 9003
- blu/blue ral 5014

main component sizes

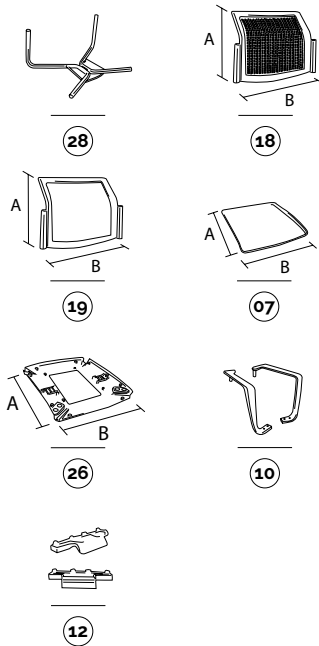

28	logan-telaio per panca senza tappi logan-bench frame caps excluded	code 110703-024	finishing ● nero/black	q.kit x1	q.pack 100	kg.x1 2,20	vol.x1 mc. 0,046		
25	tc22-tappo copritesta alettato d.22 nero tc22-inner caps-cover head d.22 black	code 134103-220	finishing ● nero/black	q.kit x2					
18	logan-schienale traforato in plastica colorato a vista logan-perforated plastic back coloured at sight	code 132103-083	finishing ● nero/black	q.kit x1	q.pack 10	a 390	b 500	kg.x1 0,82	vol.x1 mc. 0,088
19	logan-schienale pieno in plastica colorato a vista logan-full plastic back coloured at sight	code 132103-089	finishing ● nero/black	q.kit x1	q.pack 10	a 390	b 500	kg.x1 0,82	vol.x1 mc. 0,088
06	logan-tappo per telaio e schienale inner caps-cover head d.22	code 131703-029	finishing ● nero/black	q.kit x2	q.pack 20			kg.x1 0,025	vol.x1 mc. 0,001
07	logan-sedile in plastica colorato a vista logan-plastic seat coloured at sight	code 132203-082	finishing ● nero/black	q.kit x1	q.pack 10	a 430	b 460	kg.x1 0,86	vol.x1 mc. 0,01
26	logan-sottosedile esterno in plastica per telaio panca e girevole logan-outer plastic seat for swivel and bench	code 132203-081	finishing ● nero/black	q.kit x1	q.pack 20	a 420	b 450	kg.x1 0,47	vol.x1 mc. 0,007
09	logan-sacchetto con viti + pf1 per 10 sedile - per sedile e schienale portante logan-screws + pf1 for 10 chairs for seat and outer backrest	code 117000-022	finishing ● nero/black	q.kit x0,1	q.pack 1				
10	logan-coppia braccioli dx/sx in plastica logan-pair of plastic arms right/left	code 131703-031	finishing ● nero/black	q.kit x1	q.pack 10			kg.x1 0,43	vol.x1 mc. 0,051
11	logan-kit viti per 10 coppie braccioli logan-kit screws for 10 pair arms	code 117000-025	finishing ● nero/black	q.kit x0,1	q.pack 1				
12	logan-piastra di fissaggio per bracciolo logan-fixing plate for arm	code 131703-034	finishing ● nero/black	q.kit x2	q.pack 50			kg.x1 0,07	vol.x1 mc. 0,0013

for the bench components, see page 417

OPTIONAL
bench connector
E-USB
bench plug



JIM
bench leg



plastic

90GM
bench leg



90GF
bench leg



91GM NEW
bench leg



100GM
bench leg



200GM
bench leg



PIONEER
bench arm



metal

CUT
bench leg



SLIM
bench leg



CUT
bench arm



SLIM
bench arm



aluminium

logan

bench/tablet accessories

main component sizes



13

12

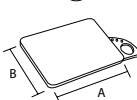
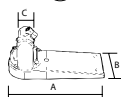

14

15

13 logan-coppia braccioli con aggancio portatavoletta in plastica
logan-pair of plastic arms right/left with writing tablet hook

code	finishing	q.kit	q.pack	kg.x1	vol.x1
131703-032	● nero/black	x1	10	0.49	mc. 0.051
131703-033	● nero/black	x1	10	0.49	mc. 0.051

11 logan-kit viti per 10 coppie braccioli
logan-kit screws for 10 pair arms

code	finishing	q.kit	q.pack	kg.x1	vol.x1
117000-025	● nero/black	x0.1	1		

12 logan-piastra di fissaggio per bracciolo
logan-fixing plate for arm

code	finishing	q.kit	q.pack	kg.x1	vol.x1
131703-034	● nero/black	x2	50	0.07	mc. 0.0013

14 spta-snodo tavoletta antipanico in alluminio lucido
spta-polished aluminium swivel safety mechanism for tablet

code	finishing	q.kit	q.pack	a	b	c	kg.x1	vol.x1
111701-900	● alluminio/aluminium destro/right	x1	10	180	66	15x15	0.365	mc. 0.001
111701-901	● alluminio/aluminium sinistro/left	x1	10	180	66	15x15	0.365	mc. 0.001

15 tlt3-tavoletta ambidestro con portabicchiere e portapenne
tlt3--writing tablet with cup holder and pen tray

code	finishing	q.kit	q.pack	a	b	kg.x1	vol.x1
134003-041	● nero/black	x1	10	410	300	1.05	mc. 0.036

TLT tablet TLT2 tablet TLT3 tablet BEAN tablet TL02 tablet SPT2 mechanism tablet SPTA mechanism antipanic



for writing tablet options, see page 404/405

bench/options

main component sizes

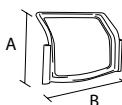

03

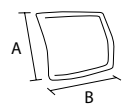

17



10

03 logan-telaio schienale in plastica portante
logan-outer back frame in plastic

code	finishing	q.kit	q.pack	a	b	kg.x1	vol.x1
132103-084	● nero/black	x1	10	390	500	0.58	mc. 0.088

17 logan-pannello schienale in plastica da tappezzare
logan-plastic panel back for upholstery

code	finishing	q.kit	q.pack	a	b	kg.x1	vol.x1
132103-086	● nero/black	x1	20	380	420	0.90	mc. 0.005

05 vite hilo tc + 4x14 zn nere
screw hilo tc+ 4x14 zn black

code	finishing	q.kit
117803-120	● nero/black	x10

10 logan-coppia braccioli dx/sx in plastica
logan-pair of plastic arms right/left

code	finishing	q.kit	q.pack	kg.x1	vol.x1
131703-031	● nero/black	x1	10	0.43	mc. 0.051

and · **11** **12** **07** **26** **09**

main component sizes

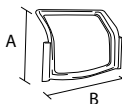

03

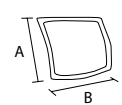

04



03 logan-telaio schienale in plastica portante
logan-outer back frame in plastic

code	finishing	q.kit	q.pack	a	b	kg.x1	vol.x1
132103-084	● nero/black	x1	10	390	500	0.58	mc. 0.088

04 logan-cornice schienale in plastica per rete
logan-open frame in plastic for mesh

code	finishing	q.kit	q.pack	a	b	kg.x1	vol.x1
132103-085	● nero/black	x1	20	380	420	0.30	mc. 0.005

and · **10** **11** **12** **07** **26** **09**



for all colour codes, see page 227

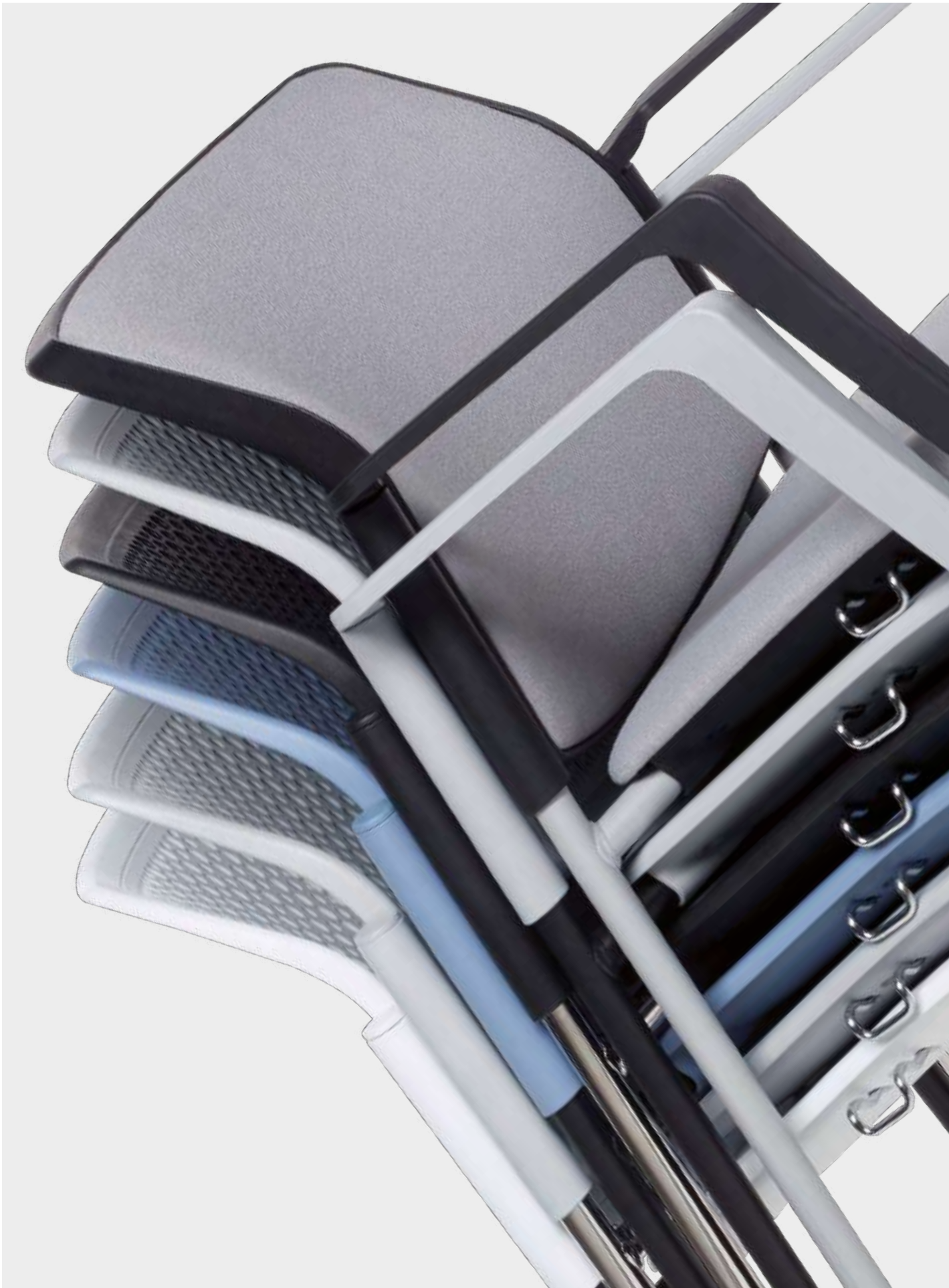



plastic colour codes



18 schienale traforato in plastica
perforated plastic backrest

- **132103-083** nero/black
- **132104-083** grigio/gray ral 7040
- **132105-083** bianco/white ral 9003
- **132115-083** blu/blue ral 5014



19 schienale pieno in plastica
full plastic backrest

- **132103-089** nero/black
- **132104-089** grigio/gray ral 7040
- **132105-089** bianco/white ral 9003
- **132115-089** blu/blue ral 5014



06 tappo in plastica
plastic inner cap

- **131703-029** nero/black
- **131704-029** grigio/gray ral 7040
- **131705-029** bianco/white ral 9003
- **131715-029** blu/blue ral 5014



07 sedile in plastica
plastic seat

- **132203-082** nero/black
- **132204-082** grigio/gray ral 7040
- **132205-082** bianco/white ral 9003
- **132215-082** blu/blue ral 5014



08 sottosedile in plastica
outer plastic seat

- **132203-080** nero/black
- **132204-080** grigio/gray ral 7040
- **132205-080** bianco/white ral 9003
- **132215-080** blu/blue ral 5014



26 sottosedile in pl. per girevole e panca
outer plastic seat for swivel and bench

- **132203-081** nero/black
- **132204-081** grigio/gray ral 7040
- **132205-081** bianco/white ral 9003
- **132215-081** blu/blue ral 5014



10 braccioli in plastica
plastic armrests

- **131703-031** nero/black
- **131704-031** grigio/gray ral 7040
- **131705-031** bianco/white ral 9003
- **131715-031** blu/blue ral 5014

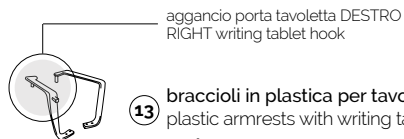

13 braccioli in plastica per tavoletta
plastic armrests with writing tablet hook

- **131703-032** L+R writ. tab. hook nero/black
- **131704-032** L+R writ. tab. hook grigio/gray ral 7040
- **131705-032** L+R writ. tab. hook bianco/white ral 9003
- **131715-032** L+R writ. tab. hook blu/blue ral 5014

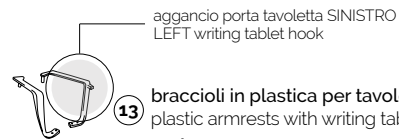

13 braccioli in plastica per tavoletta
plastic armrests with writing tablet hook

- **131703-033** R+L writ. tab. hook nero/black
- **131704-033** R+L writ. tab. hook grigio/gray ral 7040
- **131705-033** R+L writ. tab. hook bianco/white ral 9003
- **131715-033** R+L writ. tab. hook blu/blue ral 5014





pinko



discover more about
Pinko Collection

L'ampia e confortevole seduta, unita all'elevato numero di opzioni e versioni di telai e componenti disponibili, la rendono ideale per qualsiasi utilizzo in ambiente Office e Educational.

Ma non solo, la panca con sedile ribaltabile completa un assortimento vario e completo, rendendo Pinko adatto anche all'ambiente Community.

The large and comfortable seat, combined with the generous selection of options and versions of frames and components available make it ideal for use in any Office and Educational environments.

But it's versatility doesn't end there: the bench version with folding seat rounds off a range which is both varied and complete, making Pinko suitable also for Community environments.



**trolley
available**

pinko

4-legs

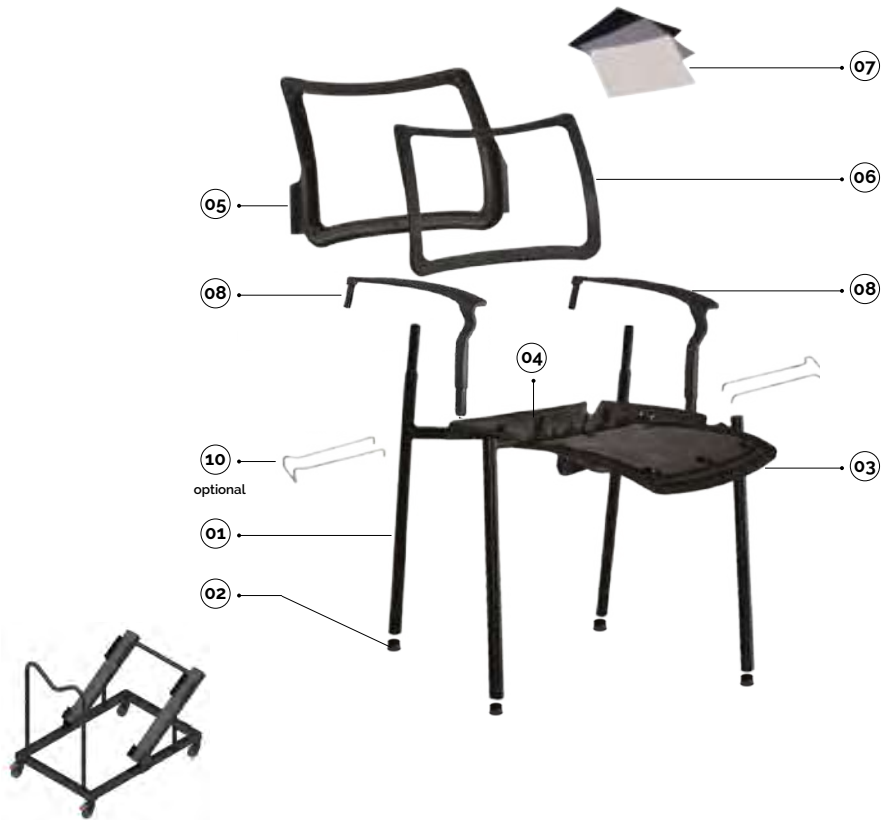

pinko-carrello portasedie con accessori
pinko-trolley for chairs with accessories

code	finishing	q.kit
110803-340	● nero/black	x1

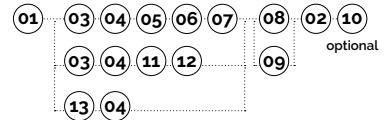

- blu/blue ral5002
- nero/black
- grigio/grey ral7035

plastic colours

main component sizes

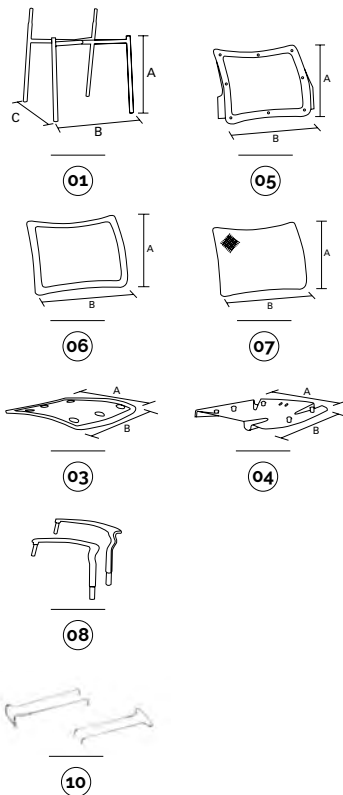

01 pinko-telaio quattro gambe fisso per braccioli senza tappi
pinko-fixed four legs frame for arms without caps

code	finishing	q.kit	q.pack	a	b	c	kg.x1	vol.x1
112603-040	● nero/black	x1	64	450	530	530	3,20	mc. 0.035
112604-040	● grigio/grey	x1	64	450	530	530	3,20	mc. 0.035
112610-040	● cromato/chrome	x1	64	450	530	530	3,20	mc. 0.035

02 confezione puntali a testa sferica d.25
cap d.25 spherical head black package

code	finishing	q.kit	q.pack
137003-075	● nero/black	x4	120

03 pinko-sedile interno da tappezzare
pinko-inner seat for upholstery

code	finishing	q.kit	q.pack	a	b	kg.x1	vol.x1
132203-025	● nero/black	x1	10	465	470	0,73	mc. 0.006

04 pinko-sedile esterno plastica
pinko-outer plastic seat

code	finishing	q.kit	q.pack	a	b	kg.x1	vol.x1
132203-026	● nero/black	x1	20	465	470	0,62	mc. 0.007

05 pinko-telaio schienale in plastica per rete (portante) + 2 tappi schienale + 2 tappi sedile
pinko-back frame in plastic for mesh + 2 back caps + 2 seat caps

code	finishing	q.kit	q.pack	a	b	kg.x1	vol.x1
132103-027	● nero/black	x2	20	345	495	0,50	mc. 0.0045

06 pinko-cornice schienale in plastica per rete
pinko-frame in plastic for mesh

code	finishing	q.kit	q.pack	a	b	kg.x1	vol.x1
132103-028	● nero/black	x1	10	345	495	0,35	mc. 0.0057

07 pinko-rete per schienale
pinko-net for pinko back

code	finishing	q.kit	q.pack	a	b	kg.x1	vol.x1
132105-501	○ bianco/white	x1	25	460	520	0,14	mc. 0.0057
132103-501	● nero/black	x1	25	460	520	0,14	mc. 0.0057
132104-501	● grigio/grey	x1	25	460	520	0,14	mc. 0.0057

08 pinko-coppia braccioli dx/sx in plastica
pinko-pair of plastic arms right/left

code	finishing	q.kit	q.pack	kg.x1	vol.x1
131703-050	● nero/black	x1	10	0,66	mc. 0.0037

10 pinko/logan-coppia agganci laterale maschio + femmina cromati
pinko/logan-chrome lateral hooks male + femal with screws

code	finishing	q.kit	q.pack	kg.x1	vol.x1
113410-100	● cromato/chrome	x1	100	0,13	mc. 0.0004

optionals

pinko

4-legs/tablet accessories

main component sizes



09



09 pinko-coppia braccioli + gancio portavoletta destro in plastica
pinko-pair of plastic arms right/left with joint for writing tablet

code	finishing	q.kit	q.pack	kg.x1	vol.x1
131703-051	● nero/black	x1	10	0,70	mc. 0,0037

TLT
tablet



TLT2
tablet



TLT3
tablet



BEAN
tablet



TL02
tablet



SPT2
mechanism tablet



SPTA
mechanism antipanic



for writing tablet options, see page 404/405

4-legs/seat and backrest options

main component sizes

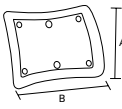

11

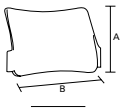

12



11 pinko-schienale interno da tappezzare
pinko-inner back for upholstery

code	finishing	q.kit	q.pack	a	b	kg.x1	vol.x1
132103-025	● nero/black	x1	20	350	495	0,62	mc. 0,009

12 pinko-schienale esterno plastica + 2 tappi schienale + 2 tappi sedile
pinko-outer plastic back + 2 back caps + 2 seat caps

code	finishing	q.kit	q.pack	a	b	kg.x1	vol.x1
132103-026	● nero/black	x1	10	350	495	0,25	mc. 0,0045

and · 03 04

main component sizes

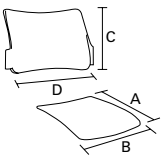

13



13 pinko-sedile/schienale in plastica colorato a vista + 2 tappi schienale + 2 tappi sedile
pinko-plastic seat/back coloured at sight + 2 back caps + 2 seat caps

code	finishing	q.kit	q.pack	a	b	c	d	kg.x1	vol.x1	
134015-108	● blu/blue	ral 5002	x1	10	470	465	350	495	1,78	mc. 0,014
134003-108	● nero/black		x1	10	470	465	350	495	1,78	mc. 0,014
134004-109	● grigio/grey	ral 7035	x1	10	470	465	350	495	1,78	mc. 0,014

and · 04

pinko

4-legs for castors



plastic colours

- blu/blue ral5002
- nero/black
- grigio/grey ral7035

main component sizes

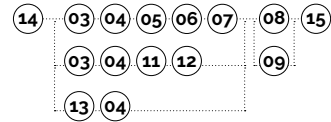
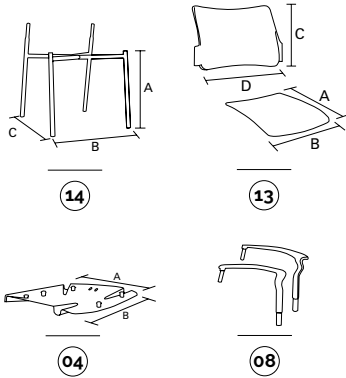

14 pinko-telaio quattro gambe per ruote + 4 riduttori per ruote pinko four legs frame for castors + 4 adapters for castors

code	finishing	q.kit	q.pack	a	b	c	kg.x1	vol.x1
112603-041	● nero/black	x1	80	390	530	530	3,20	mc. 0.035
112604-041	● grigio/grey	x1	80	390	530	530	3,20	mc. 0.035
112610-041	● cromato/chrome	x1	80	390	530	530	3,20	mc. 0.035

15 doppia ruota d.50 in desmopan con perno montato twin wheel castor d.50 desmopan with pivot mounted

code	finishing	q.kit
134403-003	● nero/black	x4

13 pinko-sedile/schienale in plastica colorato a vista + 2 tappi schienale + 2 tappi sedile pinko-plastic seat/back coloured at sight + 2 back caps + 2 seat caps

code	finishing	q.kit	q.pack	a	b	c	d	kg.x1	vol.x1
134015-108	● blu/blue ral 5002	x1	10	470	465	350	495	1,78	mc. 0.014
134003-108	● nero/black	x1	10	470	465	350	495	1,78	mc. 0.014
134004-109	● grigio/grey ral 7035	x1	10	470	465	350	495	1,78	mc. 0.014

04 pinko-sedile esterno plastica pinko-outer plastic seat

code	finishing	q.kit	q.pack	a	b	kg.x1	vol.x1
132203-026	● nero/black	x1	20	465	470	0,62	mc. 0.007

08 pinko-coppia braccioli dx/sx in plastica pinko-pair of plastic arms right/left

code	finishing	q.kit	q.pack	kg.x1	vol.x1
131703-050	● nero/black	x1	10	0,66	mc. 0.0037

pinko-carrello portasedie con accessori nero pinko-trolley for chairs with accessories black

code	finishing	q.kit
110803-340	● nero/black	x1



pinko

4-legs for castors/tablet accessories

main component sizes



09



09 pinko-coppia braccioli + gancio portavoletta destro in plastica
pinko-pair of plastic arms right/left with joint for writing tablet

code	finishing	q.kit	q.pack	kg.x1	vol.x1
131703-051	● nero/black	x1	10	0,70	mc. 0,0037

TLT
tablet

TLT2
tablet

TLT3
tablet

BEAN
tablet

TL02
tablet

SPT2
mechanism tablet

SPTA
mechanism antipanic



for writing tablet options, see page 404/405

4-legs/seat and backrest options

main component sizes

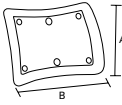

11

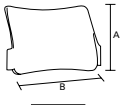

12



11 pinko-schienale interno da tappezzare
pinko-inner back for upholstery

code	finishing	q.kit	q.pack	a	b	kg.x1	vol.x1
132103-025	● nero/black	x1	20	350	495	0,62	mc. 0,009

12 pinko-schienale esterno plastica + 2 tappi schienale + 2 tappi sedile
pinko-outer plastic back + 2 back caps + 2 seat caps

code	finishing	q.kit	q.pack	a	b	kg.x1	vol.x1
132103-026	● nero/black	x1	10	350	495	0,25	mc. 0,0045

and **03** **04**

main component sizes

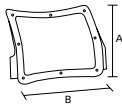

05

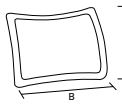

06

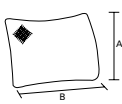

07



05 pinko-telaio schienale in plastica per rete (portante) + 2 tappi schienale + 2 tappi sedile
pinko-back frame in plastic for mesh + 2 back caps + 2 seat caps

code	finishing	q.kit	q.pack	a	b	kg.x1	vol.x1
132103-027	● nero/black	x2	20	345	495	0,50	mc. 0,0045

06 pinko-cornice schienale in plastica per rete
pinko-open frame in plastic for mesh

code	finishing	q.kit	q.pack	a	b	kg.x1	vol.x1
132103-028	● nero/black	x1	10	345	495	0,35	mc. 0,0057

07 pinko-rete per schienale
pinko-net for pinko back

code	finishing	q.kit	q.pack	a	b	kg.x1	vol.x1
132105-501	○ bianco/white	x1	25	460	520	0,14	mc. 0,0057
132103-501	● nero/black	x1	25	460	520	0,14	mc. 0,0057
132104-501	● grigio/grey	x1	25	460	520	0,14	mc. 0,0057

and **03** **04**

pinko

slide



plastic colours

- blu/blue ral5002
- nero/black
- grigio/grey ral7035

main component sizes

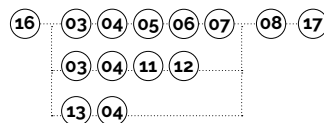
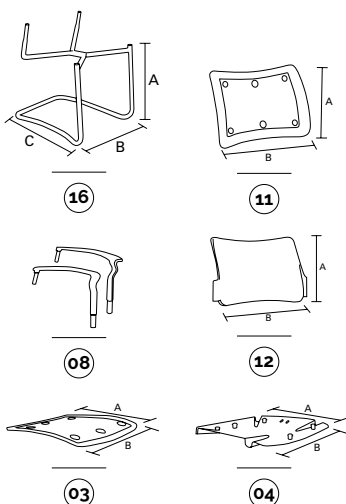

16 pinko-base a slitta in tubo asform d.25 tappi esclusi
pinko-slide frame pipe d.25 without caps

code	finishing	q.kit	q.pack	a	b	c	kg.x1	vol.x1
110503-093	● nero/black	x1	40	450	550	550	4,60	mc. 0,06
110504-093	● grigio/grey	x1	40	450	550	550	4,60	mc. 0,06
110510-093	● cromato/chrome	x1	40	450	550	550	4,60	mc. 0,06

17 paracolpi testa bombata d.18
round head cap d.18

code	finishing	q.kit
134403-101	● nero/black	x4

03 pinko-sedile interno da tappezzare
pinko-inner seat for upholstery

code	finishing	q.kit	q.pack	a	b	kg.x1	vol.x1
132203-025	● nero/black	x1	10	465	470	0,73	mc. 0,006

04 pinko-sedile esterno plastica
pinko-outer plastic seat

code	finishing	q.kit	q.pack	a	b	kg.x1	vol.x1
132203-026	● nero/black	x1	20	465	470	0,62	mc. 0,007

11 pinko-schienale interno da tappezzare
pinko-inner back for upholstery

code	finishing	q.kit	q.pack	a	b	kg.x1	vol.x1
132103-025	● nero/black	x1	20	350	495	0,62	mc. 0,009

12 pinko-schienale esterno plastica + 2 tappi schienale + 2 tappi sedile
pinko-outer plastic back + 2 back caps + 2 seat caps

code	finishing	q.kit	q.pack	a	b	kg.x1	vol.x1
132103-026	● nero/black	x1	10	350	495	0,25	mc. 0,0045

08 pinko-coppia braccioli dx/sx in plastica
pinko-pair of plastic arms right/left

code	finishing	q.kit	q.pack	kg.x1	vol.x1
131703-050	● nero/black	x1	10	0,66	mc. 0,0037

pinko

slide/seat and backrest options

main component sizes

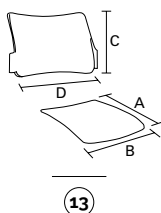

13 pinko-sedile/schienale in plastica colorato a vista + 2 tappi schienale + 2 tappi sedile
pinko-plastic seat/back coloured at sight + 2 back caps + 2 seat caps

code	finishing		q.kit	q.pack	a	b	c	d	kg.x1	vol.x1
134015-108	● blu/blue	ral 5002	x1	10	470	465	350	495	1,78	mc. 0.014
134003-108	● nero/black		x1	10	470	465	350	495	1,78	mc. 0.014
134004-109	● grigio/grey	ral 7035	x1	10	470	465	350	495	1,78	mc. 0.014

and **04**

main component sizes

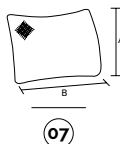
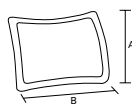
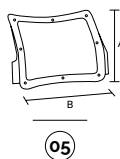

05 pinko-telaio schienale in plastica per rete (portante) + 2 tappi schienale + 2 tappi sedile
pinko-back frame in plastic for mesh + 2 back caps + 2 seat caps

code	finishing	q.kit	q.pack	a	b	kg.x1	vol.x1
132103-027	● nero/black	x2	20	345	495	0,50	mc. 0.0045

06 pinko-cornice schienale in plastica per rete
pinko-open frame in plastic for mesh

code	finishing	q.kit	q.pack	a	b	kg.x1	vol.x1
132103-028	● nero/black	x1	10	345	495	0,35	mc. 0.0057

07 pinko-rete per schienale
pinko-net for pinko back

code	finishing	q.kit	q.pack	a	b	kg.x1	vol.x1
132105-501	○ bianco/white	x1	25	460	520	0,14	mc. 0.0057
132103-501	● nero/black	x1	25	460	520	0,14	mc. 0.0057
132104-501	● grigio/grey	x1	25	460	520	0,14	mc. 0.0057

and **03** **04**

pinko

swivel



plastic colours

- blu/blue ral5002
- nero/black
- grigio/grey ral7035

main component sizes

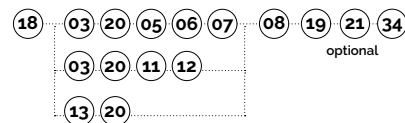
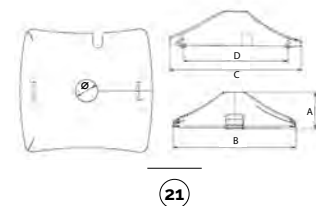
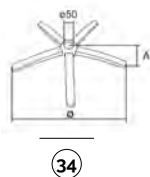
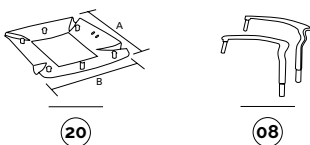
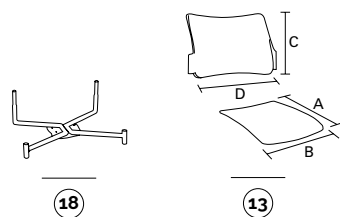

18 pinko-telaio per girevole comando a gas senza tappi
pinko-swivel frame with gas lever without caps

code	finishing	q.kit	q.pack	kg.x1	vol.x1
112603-045	● nero/black	x1	80	2,60	mc. 0,005
112604-045	● grigio/grey	x1	80	2,60	mc. 0,005

19 tappo copritesta alettato d.25 nero
cover head d.25 black

code	finishing	q.kit
134103-250	● nero/black	x2

13 pinko-sedile/schienale in plastica colorato a vista + 2 tappi schienale + 2 tappi sedile
pinko-plastic seat/back coloured at sight + 2 back caps + 2 seat caps

code	finishing	q.kit	q.pack	a	b	c	d	kg.x1	vol.x1
134015-108	● blu/blue ral 5002	x1	10	470	465	350	495	1,78	mc. 0,014
134003-108	● nero/black	x1	10	470	465	350	495	1,78	mc. 0,014
134004-109	● grigio/grey ral 7035	x1	10	470	465	350	495	1,78	mc. 0,014

20 pinko-sedile esterno plastica per girevole e panca
pinko-plastic outer seat for swivel and bench

code	finishing	q.kit	q.pack	a	b	kg.x1	vol.x1
132203-027	● nero/black	x1	20	465	470	0,60	mc. 0,007

08 pinko-coppia braccioli dx/sx in plastica
pinko-pair of plastic arms right/left

code	finishing	q.kit	q.pack	kg.x1	vol.x1
131703-050	● nero/black	x1	10	0,66	mc. 0,0037

21 cpg-copertina in plastica per telaio girevole
cpg-plastic cover for swivel frame

code	finishing	q.kit	q.pack	a	b	c	d	ø	kg.x1	vol.x1
130903-000	● nero/black	x1	50	60	200	210	167	36	0,1	mc. 0,0015

34 b40 base in metallo d.640 con coprisaldatura
b40 metal base d.640 with cover welding

code	finishing	q.kit	q.pack	a	ø	kg.x1	vol.x1
110210-027	● cromato/chrome	x1	5	60	640	2,85	mc. 0,014

CPG
plastic cover for swivel frame

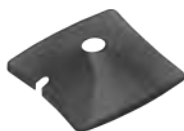

pinko

swivel/seat and backrest options

main component sizes

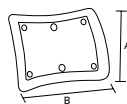

11

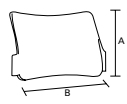

12



11 pinko-schienale interno da tappezzare pinko-inner back for upholstery

code	finishing	q.kit	q.pack	a	b	kg.x1	vol.x1
132103-025	● nero/black	x1	20	350	495	0,62	mc. 0.009

12 pinko-schienale esterno plastica + 2 tappi schienale + 2 tappi sedile pinko-outer plastic back + 2 back caps + 2 seat caps

code	finishing	q.kit	q.pack	a	b	kg.x1	vol.x1
132103-026	● nero/black	x1	10	350	495	0,25	mc. 0.0045

and .. 03 20

main component sizes

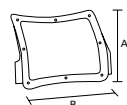

05

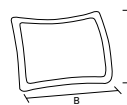

06

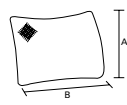

07



05 pinko-telaio schienale in plastica per rete (portante) + 2 tappi schienale + 2 tappi sedile pinko-back frame in plastic for mesh + 2 back caps + 2 seat caps

code	finishing	q.kit	q.pack	a	b	kg.x1	vol.x1
132103-027	● nero/black	x2	20	345	495	0,50	mc. 0.0045

06 pinko-cornice schienale in plastica per rete pinko-open frame in plastic for mesh

code	finishing	q.kit	q.pack	a	b	kg.x1	vol.x1
132103-028	● nero/black	x1	10	345	495	0,35	mc. 0.0057

07 pinko-rete per schienale pinko-net for pinko back

code	finishing	q.kit	q.pack	a	b	kg.x1	vol.x1
132105-501	○ bianco/white	x1	25	460	520	0,14	mc. 0.0057
132103-501	● nero/black	x1	25	460	520	0,14	mc. 0.0057
132104-501	● grigio/grey	x1	25	460	520	0,14	mc. 0.0057

and .. 03 20

pinko

bench



plastic colours

- blu/blue ral5002
- nero/black
- grigio/grey ral7035

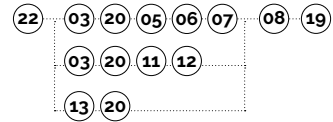

main component sizes

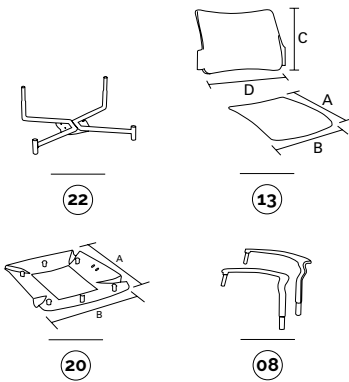

22 pinko-telaio per panca senza tappi pinko-bench frame caps excluded

code	finishing	q.kit	q.pack	kg.x1	vol.x1
110703-072	● nero/black	x1	80	2,50	mc. 0.005
110704-072	● grigio/grey	x1	80	2,50	mc. 0.005

19 tappo copritesta alettato d.25 nero cover head d.25 black

code	finishing	q.kit
134103-250	● nero/black	x2

13 pinko-sedile/schienale in plastica colorato a vista + 2 tappi schienale + 2 tappi sedile pinko-plastic seat/back coloured at sight + 2 back caps + 2 seat caps

code	finishing	q.kit	q.pack	a	b	c	d	kg.x1	vol.x1
134015-108	● blu/blue ral 5002	x1	10	470	465	350	495	1,78	mc. 0.014
134003-108	● nero/black	x1	10	470	465	350	495	1,78	mc. 0.014
134004-109	● grigio/grey ral 7035	x1	10	470	465	350	495	1,78	mc. 0.014

20 pinko-sedile esterno plastica per girevole e panca pinko-plastic outer seat for swivel and bench

code	finishing	q.kit	q.pack	a	b	kg.x1	vol.x1
132203-027	● nero/black	x1	20	465	470	0,60	mc. 0.007

08 pinko-coppia braccioli dx/sx in plastica pinko-pair of plastic arms right/left

code	finishing	q.kit	q.pack	kg.x1	vol.x1
131703-050	● nero/black	x1	10	0,66	mc. 0.0037

for the bench components, see page 417

optionals

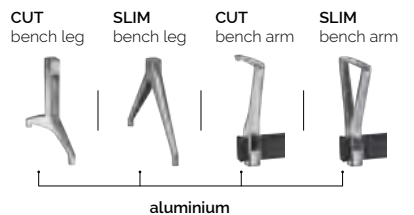
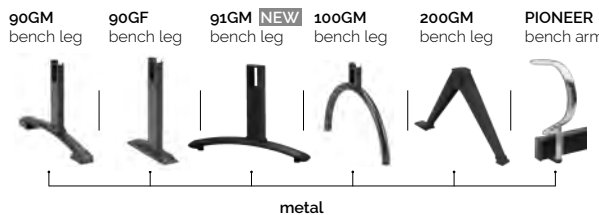
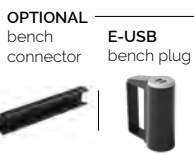

pinko

bench/seat and backrest options

main component sizes

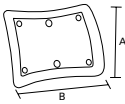

11

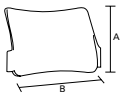

12



11 pinko-schienale interno da tappezzare
pinko-inner back for upholstery

code	finishing	q.kit	q.pack	a	b	kg.x1	vol.x1
132103-025	● nero/black	x1	20	350	495	0,62	mc. 0.009

12 pinko-schienale esterno plastica + 2 tappi schienale + 2 tappi sedile
pinko-outer plastic back + 2 back caps + 2 seat caps

code	finishing	q.kit	q.pack	a	b	kg.x1	vol.x1
132103-026	● nero/black	x1	10	350	495	0,25	mc. 0.0045

and **03** **20**

main component sizes

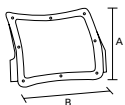

05

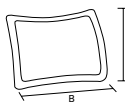

06

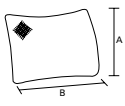

07



05 pinko-telaio schienale in plastica per rete (portante) + 2 tappi schienale + 2 tappi sedile
pinko-back frame in plastic for mesh + 2 back caps + 2 seat caps

code	finishing	q.kit	q.pack	a	b	kg.x1	vol.x1
132103-027	● nero/black	x2	20	345	495	0,50	mc. 0.0045

06 pinko-cornice schienale in plastica per rete
pinko-open frame in plastic for mesh

code	finishing	q.kit	q.pack	a	b	kg.x1	vol.x1
132103-028	● nero/black	x1	10	345	495	0,35	mc. 0.0057

07 pinko-rete per schienale
pinko-net for pinko back

code	finishing	q.kit	q.pack	a	b	kg.x1	vol.x1
132105-501	○ bianco/white	x1	25	460	520	0,14	mc. 0.0057
132103-501	● nero/black	x1	25	460	520	0,14	mc. 0.0057
132104-501	● grigio/grey	x1	25	460	520	0,14	mc. 0.0057

and **03** **20**

pinko

folding bench

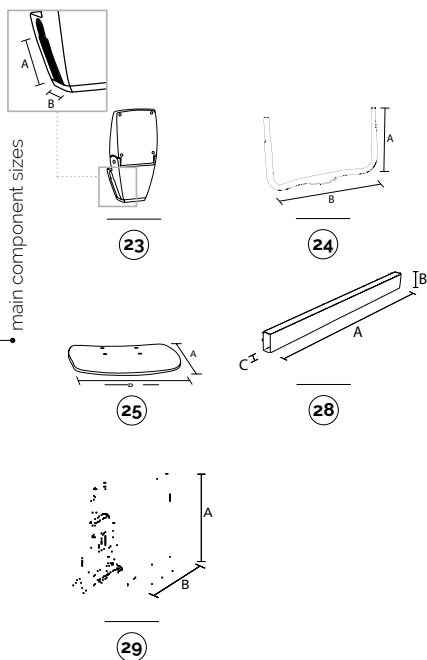
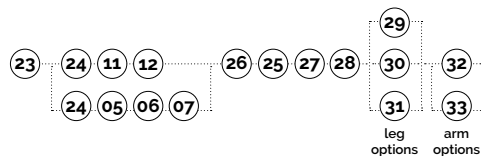

main component sizes

23 siton-meccanismo panca ribaltabile alluminio lucido siton-polished aluminium mechanism for folding bench

code	finishing	q.kit	q.pack	a	b	kg.x1	vol.x1
110704-180	● alluminio/aluminium	x1	4	80	40	2,81	mc. 0,007

24 pinko-telaio schienale a U per panca ribaltabile pinko-frame back bench for folding

code	finishing	q.kit	q.pack	a	b	kg.x1	vol.x1
110703-071	● nero/black	x1	15	300	490	1,40	mc. 0,003
110704-182	● grigio/grey	x1	15	300	490	1,40	mc. 0,003

25 siton-sedile panca ribaltabile in legno per tappezzeria siton-bench seat folding wooden for upholstery

code	finishing	q.kit	q.pack	a	b	kg.x1	vol.x1
122207-003	● grezzo/raw	x1	10	420	410	1,30	mc. 0,007

26 vite tcei m5x16 brunita nera (vite per fissaggio telaio schienale in tubo) screw m5x16 cylindrical head hexagon embedded burnishing black (screw for tube back frame fixing)

code	finishing	q.kit
117703-160	● nero/black	x4

27 vite tcei m6x20 zincata (vite per fissaggio sedile) screw m6x20 cylindrical head hexagon embedded burnishing zinc (screw for seat fixing)

code	finishing	q.kit
117711-198	● zincata/zinc	x4

28 90T(03) trave per panca 80x40 90T(03) beam for bench 80x40

code	finishing		q.kit	q.pack	a	b	c	kg.x1	vol.x1
110703-190	● nero/black	2 posti / 2 seats	x1	1	1160	80	40	3,20	mc. 0,0045
110704-190	● grigio/grey	2 posti / 2 seats	x1	1	1160	80	40	3,20	mc. 0,0045
110703-191	● nero/black	3 posti / 3 seats	x1	1	1710	80	40	4,71	mc. 0,005
110704-191	● grigio/grey	3 posti / 3 seats	x1	1	1710	80	40	4,71	mc. 0,005
110703-192	● nero/black	4 posti / 4 seats	x1	1	2260	80	40	6,22	mc. 0,0085
110704-192	● grigio/grey	4 posti / 4 seats	x1	1	2260	80	40	6,22	mc. 0,0085
110703-193	● nero/black	5 posti / 5 seats	x1	1	2800	80	40	7,72	mc. 0,001
110704-193	● grigio/grey	5 posti / 5 seats	x1	1	2800	80	40	7,72	mc. 0,001

29 90GF(02)-gamba fissa per panca con accessori 90GF(02)-fixed leg for bench with accessories

code	finishing	q.kit	q.pack	a	b	kg.x1	vol.x1
110703-122	● nero/black	x2	2	320	310	1,80	mc. 0,0012
110704-107	● grigio/grey	x2	2	320	310	1,80	mc. 0,0012

for the components below, see previous pages

for the bench components, see page 417

pinko

folding bench/tablet accessories



for writing tablet options, see page 404/405

folding bench/seat and backrest option

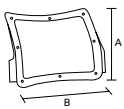

05

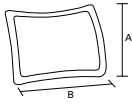

06

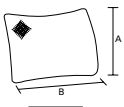

07



- 05 pinko-telaio schienale in plastica per rete (portante) + 2 tappi schienale + 2 tappi sedile
pinko-back frame in plastic for mesh + 2 back caps + 2 seat caps

code	finishing	q.kit	q.pack	a	b	kg.x1	vol.x1
132103-027	● nero/black	x2	20	345	495	0,50	mc. 0.0045

- 06 pinko-cornice schienale in plastica per rete
pinko-open frame in plastic for mesh

code	finishing	q.kit	q.pack	a	b	kg.x1	vol.x1
132103-028	● nero/black	x1	10	345	495	0,35	mc. 0.0057

- 07 pinko-rete per schienale
pinko-net for pinko back

code	finishing	q.kit	q.pack	a	b	kg.x1	vol.x1
132105-501	○ bianco/white	x1	25	460	520	0,14	mc. 0.0057
132103-501	● nero/black	x1	25	460	520	0,14	mc. 0.0057
132104-501	● grigio/grey	x1	25	460	520	0,14	mc. 0.0057

and 24 26 25 27

folding bench/leg and armrest options

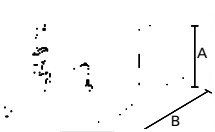

05



- 30 90gm(02)-gamba mobile per panca con accessori
90gm(02)-movable leg for bench with accessories

code	finishing	q.kit	q.pack	a	b	kg.x1	vol.x1
110703-120	● nero/black	x2	2	320	600	2,70	mc. 0.0012
110704-099	● grigio/grey	x2	2	320	600	2,70	mc. 0.0012
110710-007	● cromato/chrome	x2	2	320	600	2,70	mc. 0.0012

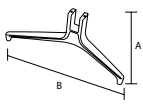

05



- 31 siton(ga02)-gamba lunga in alluminio per panca
siton(ga02)-long leg aluminium for bench

code	finishing	q.kit	q.pack	a	b	kg.x1	vol.x1
110704-171	● alluminio/aluminium	x2	5	305	643	2,80	mc. 0.014

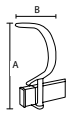

05



- 32 siton-bracciolo ellittico per panca con accessori
siton-elliptical arm for bench with accessories

code	finishing	q.kit	q.pack	a	b	kg.x1	vol.x1
111710-020	● cromato/chrome	x1	5	370	340	1,70	mc. 0.015
111703-019	● nero/black	x1	5	370	340	1,70	mc. 0.015

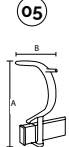

05



- 33 siton.p-bracciolo ellittico per panca con gancio porta tavoletta con accessori
siton.p-elliptical arm for bench with table hook with accessories

code	finishing	q.kit	q.pack	a	b	kg.x1	vol.x1
111710-017	● cromato/chrome	x1	5	370	340	1,70	mc. 0.015
111703-017	● nero/black	x1	5	370	340	1,70	mc. 0.015



X3



discover more about
X3 Collection

Una seduta in plastica disponibile in 4 colori, caratterizzata da un design distintivo.

Prevede diverse versioni: schienale in plastica pieno o traforato, schienale in rete, pannelli sedile e schienale in plastica da tappezzare.

È inoltre possibile scegliere tra un ampio assortimento di telai, offrendo così soluzioni differenti per ambienti Office e Community, grazie anche alla pratica impilabilità.

Plastic chair available in 4 colours, characterized by a distinctive design.

Available in a range of different versions: solid or perforated plastic back, mesh back, or seat and back panels in plastic to be upholstered.

With a wide selection of frames to choose from it offers a full range of solutions for Office and Community environments, and its stackability means it's also highly practical.

Plus

- Certificazione ANSI/BIFMA X5.1.
- ANSI/BIFMA X5.1 Certification.



certified
product

X3 slide

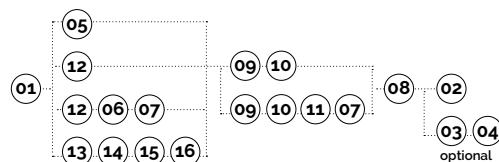

plastic colours

- grigio/gray ral 7003
- nero/black
- rosso/red 527
- bianco/white ral 1013

x3-carrello portasedie con accessori
x3-trolley for chairs with accessories

code	finishing	q.kit	kg.x1
110803-346	● nero/black	x1	10,50

main component sizes

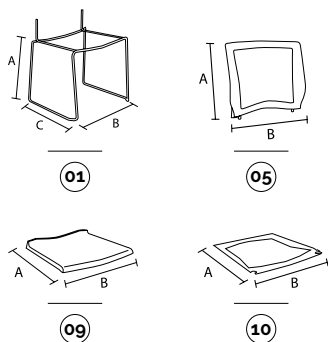

optionals

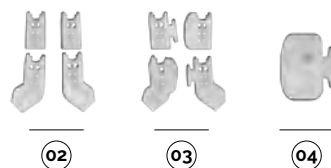

01 x3-telaio a slitta in tondino d.12
x3-slide wire frame d.12

code	finishing	q.kit	q.pack	a	b	c	kg.x1	vol.x1
113410-062	● cromato/chrome	x1	60	450	530	505	4,20	mc. 0.03

02 btf-kit piedini
btf-kit feet

code	finishing	q.kit	q.pack	kg.x1
134306-001	○ neutro/neutral	x1	100	0,05

03 btf-kit piedini con ganci
btf-kit feet with hooks

code	finishing	q.kit	q.pack	kg.x1
134306-002	○ neutro/neutral	x1	100	0,06

04 pptf-tappo per fissaggio pavimento
pptf-cap for fixing to the floor

code	finishing	q.kit	q.pack	kg.x1
134306-003	○ neutro/neutral	x2	100	0,03

05 x3-schienale colorato a vista in plastica pieno
x3-colored full plastic back

code	finishing	q.kit	q.pack	a	b	kg.x1	vol.x1
132103-090	● nero/black	x1	10	400	460	0,90	mc. 0.008

08 x3-riduttore per schienale in plastica
x3-plastic adapter for the back

code	finishing	q.kit	q.pack	kg.x1	vol.x1
132103-009	● nero/black	x2	200	0,019	mc. 0.0001

09 x3-sedile colorato a vista in plastica per telaio slitta
x3-colored plastic seat for wire frame

code	finishing	q.kit	q.pack	a	b	kg.x1	vol.x1
132203-019	● nero/black	x1	10	450	460	1,20	mc. 0.015

10 x3-sottosedile colorato a vista in plastica
x3-outer colored plastic seat

code	finishing	q.kit	q.pack	a	b	kg.x1	vol.x1
132203-009	● nero/black	x1	20	450	460	0,73	mc. 0.007



for all colour codes, see page 259

X3

slide/backrest and seat options

main component sizes

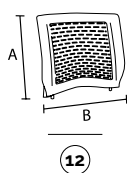

12



CERTIFIED BY
BIFMA

12 x3-schienale colorato a vista in plastica forato
x3-colored plastic back with holes

code	finishing	q.kit	q.pack	a	b	kg.x1	vol.x1
132102-019	● rosso/red 527	x1	10	400	460	0,90	mc. 0.008

and · (09) (10)

main component sizes

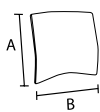

06



06 x3-pannello schienale da tappezzare in plastica
x3-back panel for upholstery

code	finishing	q.kit	q.pack	a	b	kg.x1	vol.x1
132103-008	● nero/black	x1	20	350	385	0,50	mc. 0.003

11 x3-pannello sedile da tappezzare in plastica
x3-seat panel for upholstery

code	finishing	q.kit	q.pack	a	b	kg.x1	vol.x1
132203-003	● nero/black	x1	20	400	410	0,60	mc. 0.003

07 vite hilo tb+ 5x12 cementata brunita nera
screw tb+fr.hilo 5x12 black burnished

code	finishing	q.kit seat	q.kit back
117803-154	● nero/black	x8	x6

and · (12) (09) (10)

main component sizes

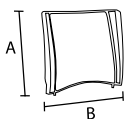

13



13 x3-schienale per rete nero a vista in plastica
x3-black plastic for mesh back

code	finishing	q.kit	q.pack	a	b	kg.x1	vol.x1
132103-014	● nero/black	x1	10	400	460	0,60	mc. 0.008

14 x3-liste a*b per schienale rete nere a vista
x3-black plastic strips a*b for mesh back

code	finishing	q.kit	q.pack	kg.x1	vol.x1
132103-013	● nero/black	x1	100	0,21	mc. 0.0004

15 x3-rete per schienale
x3-net for back

code	finishing	q.kit	q.pack	a	b	kg.x1	vol.x1
132103-029	● nero/black	x1	50	400	460	0,14	mc. 0.0057

16 vite truciolare tsp+ d.3,5x10 brunita nera(per fissare schienale rete)
shaving screw tsp+ d.3,5x10 zinc.(to fix mesh back)

code	finishing	q.kit
117803-105	● nero/black	x8

and · (09) (10) (11) (07)

X3

slide w/writing tablet

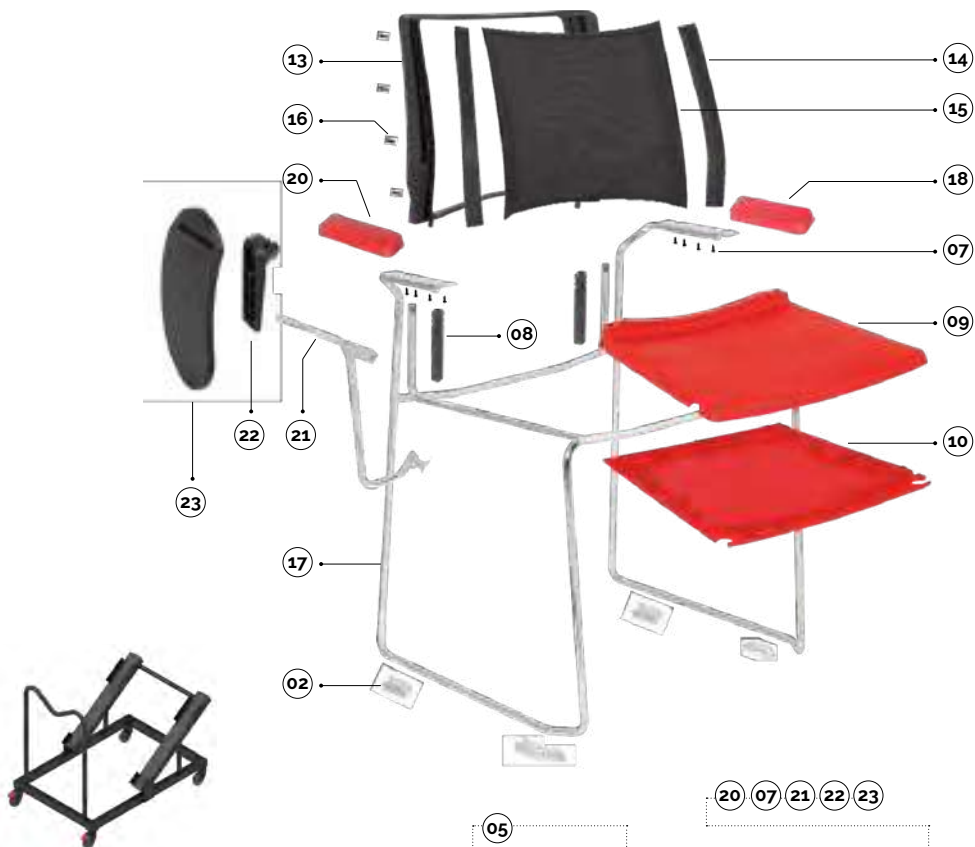

plastic colours

- grigio/gray ral 7003
- nero/black
- rosso/red 527
- bianco/white ral 1013

x3-carrello portasedie con accessori
x3-trolley for chairs with accessories

code	finishing	q.kit	kg.x1
110803-346	● nero/black	x1	10,50

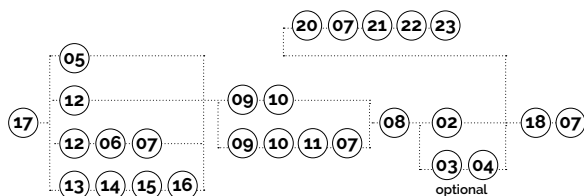

main component sizes

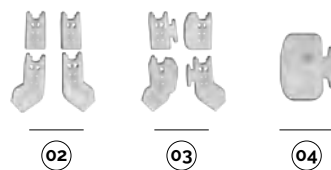
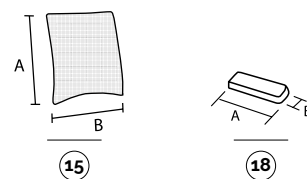
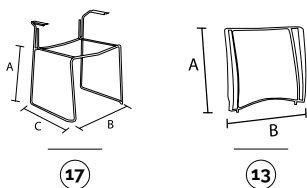

optionals

17 x3-telaio a slitta in tondino d.12 con braccioli
x3-slide wire frame d.12 with arms

code	finishing	q.kit	q.pack	a	b	c	kg.x1	vol.x1
113410-061	● cromato/chrome	x1	60	450	530	505	5,00	mc. 0.0035

13 x3-schienale per rete nero a vista in plastica
x3-black plastic for mesh back

code	finishing	q.kit	q.pack	a	b	kg.x1	vol.x1
132103-014	● nero/black	x1	10	400	460	0,60	mc. 0.008

14 x3-liste a*b per schienale rete nere a vista
x3-black plastic strips a*b for mesh back

code	finishing	q.kit	q.pack	kg.x1	vol.x1
132103-013	● nero/black	x1	100	0,21	mc. 0.0004

15 x3-rete per schienale
x3-net for back

code	finishing	q.kit	q.pack	a	b	kg.x1	vol.x1
132103-029	● nero/black	x1	50	400	460	0,14	mc. 0.0057

16 vite truciolare tsp+ d.3,5x10 brunita nera(per fissare schienale rete)
shaving screw tsp+ d.3,5x10 zinc.(to fix mesh back)

code	finishing	q.kit
117803-105	● nero/black	x8

18 x3-bracciolo plastica colorato per telaio filo
x3-colored plastic arm for wire frame

code	finishing	q.kit	q.pack	a	b	kg.x1	vol.x1	
131702-019	● rosso/red	527	x2	40	175	55	0,10	mc. 0.0004

07 vite hilo tb+ 5x12 cementata brunita nera
screw tb+fr.hilo 5x12 black burnished

code	finishing	q.kit seat	q.kit back
117803-154	● nero/black	x8	x6

for the components below, see previous pages

02 03 04 08 09 10



for all colour codes, see page 259

X3

slide/tablet accessories

main component sizes

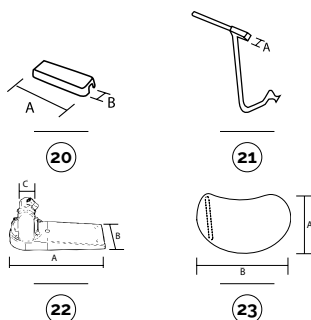

20 x3-bracciolo plastica colorato per telaio filo con tavoletta

x3-colored plastic arm for wire frame with tablet

code	finishing		q.kit	q.pack	a	b	kg.x1	vol.x1
131702-018	● rosso/red	527	x2	40	175	55	0,10	mc. 0,0004

21 x3-supperto tavoletta per slitta + viti

x3-tablet support for slide wire frame d.12 + screws

code	finishing		q.kit	q.pack		kg.x1	vol.x1
111703-044	● nero/black	destra/right - slitta/slide	x1	10	15x15	0,60	mc. 0,002
111703-047	● nero/black	sinistro/left - slitta/slide	x1	10	15x15	0,60	mc. 0,002
111710-044	● cromato/chrome	destra/right - slitta/slide	x1	10	15x15	0,60	mc. 0,002
111710-047	● cromato/chrome	sinistro/left - slitta/slide	x1	10	15x15	0,60	mc. 0,002

22 spt2-snodo per tavoletta in plastica

spt2-mechanism for writing tablet in plastic

code	finishing		q.kit	q.pack	a	b	c	kg.x1	vol.x1
134003-039	● nero/black		x1	20	180	66	15x15	0,35	mc. 0,0006

23 bean-tavoletta in plastica spessore 16

bean-writing tablet in plastic thickness 16 mm

code	finishing		q.kit	q.pack	a	b	kg.x1	vol.x1
134003-044	● nero/black		x1	20	235	370	0,40	mc. 0,002



for writing tablet options, see page 404/405

slide w/armrests/backrest and seat options

main component sizes

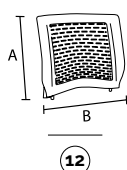

12 x3-schienale colorato a vista in plastica forato

x3-colored plastic back with holes

code	finishing		q.kit	q.pack	a	b	kg.x1	vol.x1
132102-019	● rosso/red	527	x1	10	400	460	0,90	mc. 0,008

and · 09 10

main component sizes

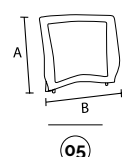

05 x3-schienale colorato a vista in plastica pieno

x3-colored full plastic back

code	finishing		q.kit	q.pack	a	b	kg.x1	vol.x1
132103-090	● nero/black		x1	10	400	460	0,90	mc. 0,008

and · 09 10

main component sizes

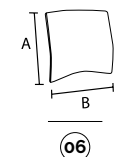

06 x3-pannello schienale da tappezzare in plastica

x3-back panel for upholstery

code	finishing		q.kit	q.pack	a	b	kg.x1	vol.x1
132103-008	● nero/black		x1	20	350	385	0,50	mc. 0,003

11 x3-pannello sedile da tappezzare in plastica

x3-seat panel for upholstery

code	finishing		q.kit	q.pack	a	b	kg.x1	vol.x1
132203-003	● nero/black		x1	20	400	410	0,60	mc. 0,003

07 vite hilo tb* 5x12 cementata brunita nera

screw tb+fr.hilo 5x12 black burnished

code	finishing		q.kit seat	q.kit back
117803-154	● nero/black		x8	x6

and · 12 09 10

X3

4-legs

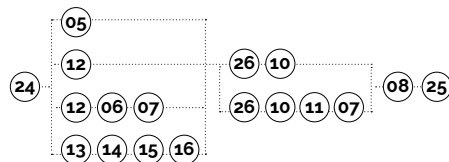

plastic colours

- grigio/gray ral 7003
- nero/black
- rosso/red 527
- bianco/white ral 1013

x3-carrello portasedie con accessori
x3-trolley for chairs with accessories

code	finishing	q.kit	kg.x1
110803-346	● nero/black	x1	10,50

main component sizes

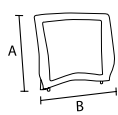
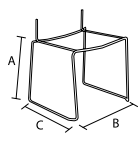

24

25

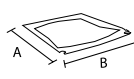

26

08

24 x3-telaio 4 gambe d.18

x3-4 legs frame d.18

code	finishing	q.kit	q.pack	a	b	c	kg.x1	vol.x1
112703-050	● nero/black	x1	60	455	465	550	2,20	mc. 0.03
112704-050	● grigio/gray	x1	60	455	465	550	2,20	mc. 0.03
112710-050	● cromato/chrome	x1	60	455	465	550	2,20	mc. 0.03

25 confezione puntali tondi d.18 neri

black inner round caps d.18 package

code	finishing	q.kit	q.pack
137003-072	● nero/black	x4	200

05 x3-schienale colorato a vista in plastica pieno

x3-colored full plastic back

code	finishing	q.kit	q.pack	a	b	kg.x1	vol.x1
132103-090	● nero/black	x1	10	400	460	0,90	mc. 0,008

08 x3-riduttore per schienale in plastica

x3-plastic adapter for the back

code	finishing	q.kit	q.pack	kg.x1	vol.x1
132103-009	● nero/black	x2	200	0,019	mc. 0,0001

26 x3-sedile colorato a vista in plastica per telaio 4 gambe

x3-colored plastic seat for 4-legs frame

code	finishing	q.kit	q.pack	a	b	kg.x1	vol.x1
132203-018	● nero/black	x1	10	450	460	1,20	mc. 0,015

10 x3-sottosedile colorato a vista in plastica

x3-outer colored plastic seat

code	finishing	q.kit	q.pack	a	b	kg.x1	vol.x1
132203-009	● nero/black	x1	20	450	460	0,73	mc. 0,007



for all colour codes, see page 259

X3

4-legs/backrest and seat options

main component sizes

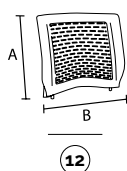

12 x3-schienale colorato a vista in plastica forato
x3-colored plastic back with holes

code	finishing	q.kit	q.pack	a	b	kg.x1	vol.x1
132102-019	● rosso/red 527	x1	10	400	460	0,90	mc. 0.008

and · **26** **10**

main component sizes

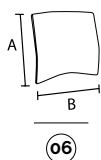

06 x3-pannello schienale da tappezzare in plastica
x3-back panel for upholstery

code	finishing	q.kit	q.pack	a	b	kg.x1	vol.x1
132103-008	● nero/black	x1	20	350	385	0,50	mc. 0.003

11 x3-pannello sedile da tappezzare in plastica
x3-seat panel for upholstery

code	finishing	q.kit	q.pack	a	b	kg.x1	vol.x1
132203-003	● nero/black	x1	20	400	410	0,60	mc. 0.003

07 vite hilo tb+ 5x12 cementata brunita nera
screw tb+fr.hilo 5x12 black burnished

code	finishing	q.kit seat	q.kit back
117803-154	● nero/black	x8	x6

and · **12** **26** **10**

main component sizes

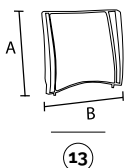

13 x3-schienale per rete nero a vista in plastica
x3-black plastic for mesh back

code	finishing	q.kit	q.pack	a	b	kg.x1	vol.x1
132103-014	● nero/black	x1	10	400	460	0,60	mc. 0.008

14 x3-liste a*b per schienale rete nere a vista
x3-black plastic strips a*b for mesh back

code	finishing	q.kit	q.pack	kg.x1	vol.x1
132103-013	● nero/black	x1	100	0,21	mc. 0.0004

15 x3-rete per schienale
x3-net for back

code	finishing	q.kit	q.pack	a	b	kg.x1	vol.x1
132103-029	● nero/black	x1	50	400	460	0,14	mc. 0.0057

16 vite truciolare tsp+ d.3,5x10 brunita nera(per fissare schienale rete)
shaving screw tsp+ d.3,5x10 zinc.(to fix mesh back)

code	finishing	q.kit
117803-105	● nero/black	x8

and · **26** **10** **11** **07**

X3

4-legs w/writing tablet

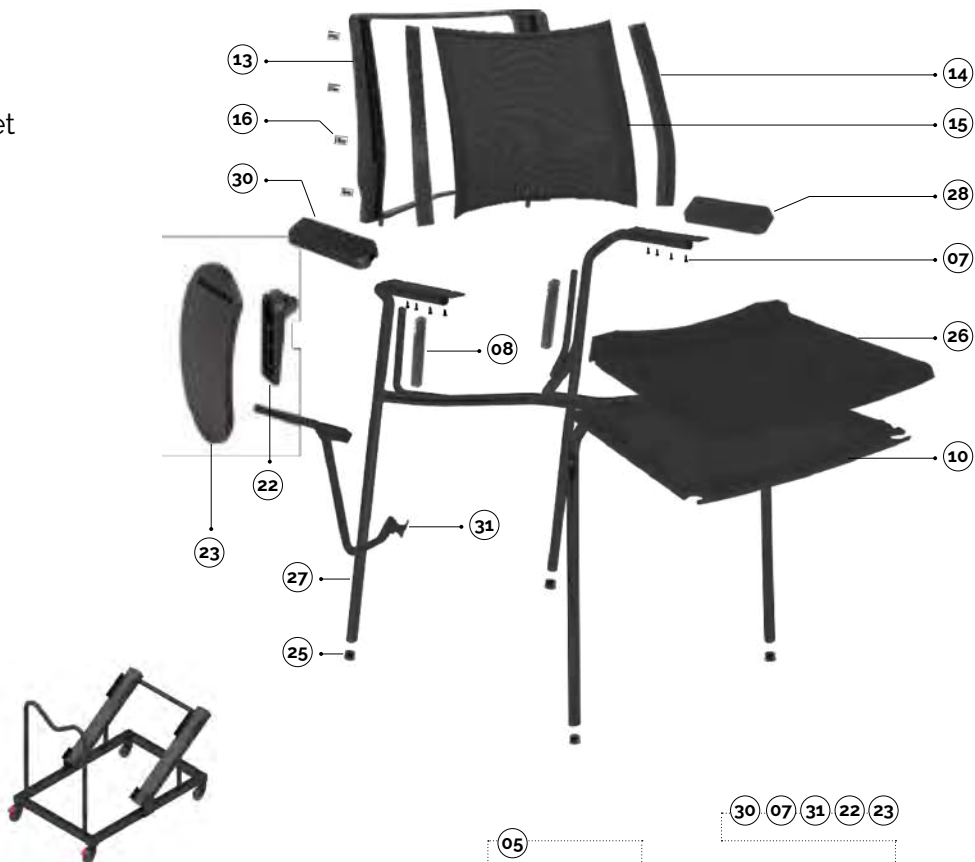

plastic colours

- grigio/gray ral 7003
- nero/black
- rosso/red 527
- bianco/white ral 1013

x3-carrello portasedie con accessori
x3-trolley for chairs with accessories

code	finishing	q.kit	kg.x1
110803-346	● nero/black	x1	10,50

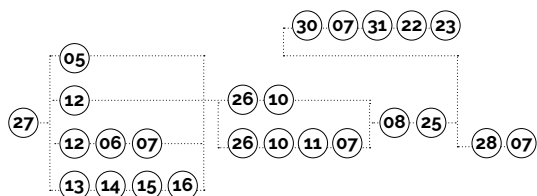

main component sizes

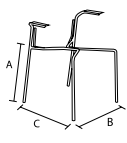

27

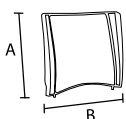

13

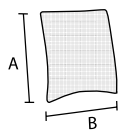

15

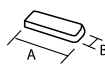

28

27 x3-telaio 4 gambe d.18 con braccioli
x3-4 legs frame d.18 with arms

code	finishing	q.kit	q.pack	a	b	c	kg.x1	vol.x1
112703-051	● nero/black	x1	60	455	465	550	2,80	mc. 0.035
112704-051	● grigio/gray	x1	60	455	465	550	2,80	mc. 0.035
112710-054	● cromato/chrome	x1	60	455	465	550	2,80	mc. 0.035

13 x3-schienale per rete nero a vista in plastica
x3-black plastic for mesh back

code	finishing	q.kit	q.pack	a	b	kg.x1	vol.x1
132103-014	● nero/black	x1	10	400	460	0,60	mc. 0.008

14 x3-liste a+b per schienale rete nere a vista
x3-black plastic strips a+b for mesh back

code	finishing	q.kit	q.pack	kg.x1	vol.x1
132103-013	● nero/black	x1	100	0,21	mc. 0.0004

15 x3-rete per schienale
x3-net for back

code	finishing	q.kit	q.pack	a	b	kg.x1	vol.x1
132103-029	● nero/black	x1	50	400	460	0,14	mc. 0.0057

16 vite truccolare tsp+ d.3,5x10 brunita nera(per fissare schienale rete)
shaving screw tsp+ d.3,5x10 zinc.(to fix mesh back)

code	finishing	q.kit
117803-105	● nero/black	x8

28 x3-bracciolo plastica colorato per telaio 4 gambe
x3-colored plastic arm for 4 legs frame

code	finishing	q.kit	q.pack	a	b	kg.x1	vol.x1
131703-017	● nero/black	x2	40	175	55	0,10	mc. 0.0004

07 vite hilo tb+ 5x12 cementata brunita nera
screw tb+fr.hilo 5x12 black burnished

code	finishing	q.kit seat	q.kit back
117803-154	● nero/black	x8	x6

for the components below, see previous pages



for all colour codes, see page 259

25 08 26 10

X3

4-legs/tablet accessories

main component sizes

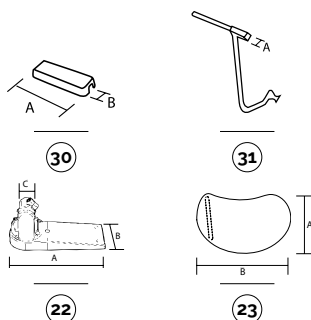

30 x3-bracciolo plastica colorato per telaio 4 gambe con tavoletta

x3-colored plastic arm for 4 legs frame with tablet

code	finishing	q.kit	q.pack	a	b	kg.x1	vol.x1
131703-014	● nero/black	x2	40	175	55	0,10	mc. 0,0004

31 x3-supperto tavoletta per 4 gambe + viti

x3-tablet support for 4 legs frame + screws

code	finishing	q.kit	q.pack	kg.x1	vol.x1
111703-043	● nero/black destro/right - 4 gambe/legs	x1	10	0,60	mc. 0,002
111703-046	● nero/black sinistro/left - 4 gambe/legs	x1	10	0,60	mc. 0,002
111710-037	● cromato/chrome destro/right - 4 gambe/legs	x1	10	0,60	mc. 0,002
111710-039	● cromato/chrome sinistro/left - 4 gambe/legs	x1	10	0,60	mc. 0,002

22 spt2-snodo per tavoletta in plastica

spt2-mechanism for writing tablet in plastic

code	finishing	q.kit	q.pack	a	b	c	kg.x1	vol.x1
134003-039	● nero/black	x1	20	180	66	15x15	0,35	mc. 0,0006

23 bean-tavoletta in plastica spessore 16

bean-writing tablet in plastic thickness 16 mm

code	finishing	q.kit	q.pack	a	b	kg.x1	vol.x1
134003-044	● nero/black	x1	20	235	370	0,40	mc. 0,002



for writing tablet options, see page 404/405

4-legs w/armrests/backrest and seat options

main component sizes

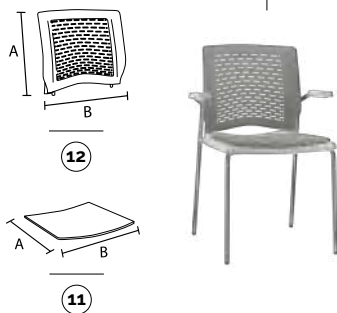

CERTIFIED BY
BIFMA

12 x3-schienale colorato a vista in plastica forato

x3-colored plastic back with holes

code	finishing	q.kit	q.pack	a	b	kg.x1	vol.x1
132104-019	● grigio/gray ral 7003	x1	10	400	460	0,90	mc. 0,008

11 x3-pannello sedile da tappezzare in plastica

x3-seat panel for upholstery

code	finishing	q.kit	q.pack	a	b	kg.x1	vol.x1
132203-003	● nero/black	x1	20	400	410	0,60	mc. 0,003

07 vite hilo tb• 5x12 cementata brunita nera

screw tb+fr.hilo 5x12 black burnished

code	finishing	q.kit seat	q.kit back
117803-154	● nero/black	x8	x6

and **26** **10**

main component sizes

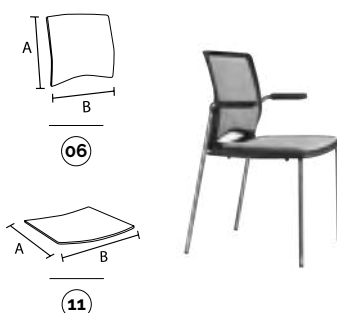

06 x3-pannello schienale da tappezzare in plastica

x3-back panel for upholstery

code	finishing	q.kit	q.pack	a	b	kg.x1	vol.x1
132103-008	● nero/black	x1	20	350	385	0,50	mc. 0,003

11 x3-pannello sedile da tappezzare in plastica

x3-seat panel for upholstery

code	finishing	q.kit	q.pack	a	b	kg.x1	vol.x1
132203-003	● nero/black	x1	20	400	410	0,60	mc. 0,003

07 vite hilo tb• 5x12 cementata brunita nera

screw tb+fr.hilo 5x12 black burnished

code	finishing	q.kit seat	q.kit back
117803-154	● nero/black	x8	x6

and **12** **26** **10**

X3

swivel



plastic colours

- grigio/gray ral 7003
- nero/black
- rosso/red 527
- bianco/white ral 1013

main component sizes

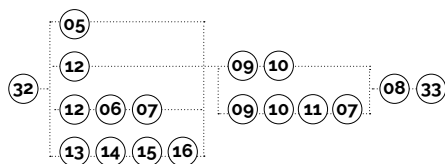
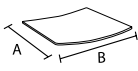
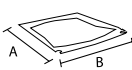
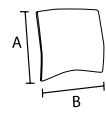
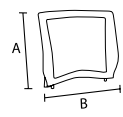
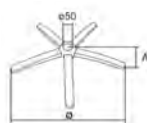

32 x3-telaio girevole a gas x3-swivel wire frame d.12

code	finishing	q.kit	q.pack	kg.x1	vol.x1
110903-028	● nero/black	x1	100	3,00	mc. 0,02
110904-014	● grigio/gray	x1	100	3,00	mc. 0,02

33 b40 base in metallo d.640 con coprisaldatura b40 metal base d.640 with cover welding

code	finishing	q.kit	q.pack	a	o	kg.x1	vol.x1
110210-027	● cromato/chrome	x1	5	60	640	2,85	mc. 0,014

05 x3-schienale colorato a vista in plastica pieno x3-colored full plastic back

code	finishing	q.kit	q.pack	a	b	kg.x1	vol.x1
132103-090	● nero/black	x1	10	400	460	0,90	mc. 0,008

06 x3-pannello schienale da tappezzare in plastica x3-colored full plastic back

code	finishing	q.kit	q.pack	a	b	kg.x1	vol.x1
132103-008	● nero/black	x1	20	350	385	0,50	mc. 0,003

07 vite hilo tb* 5x12 cementata brunita nera screw tb+fr.hilo 5x12 black burnished

code	finishing	q.kit seat	q.kit back
117803-154	● nero/black	x8	x6

08 x3-riduttore per schienale in plastica x3-plastic adapter for the back

code	finishing	q.kit	q.pack	kg.x1	vol.x1
132103-009	● nero/black	x2	200	0,019	mc. 0,0001

09 x3-sedile colorato a vista in plastica per telaio slitta x3-colored plastic seat for wire frame

code	finishing	q.kit	q.pack	a	b	kg.x1	vol.x1
132203-019	● nero/black	x1	10	450	460	1,20	mc. 0,015

10 x3-sottosedile colorato a vista in plastica x3-outer colored plastic seat

code	finishing	q.kit	q.pack	a	b	kg.x1	vol.x1
132203-009	● nero/black	x1	20	450	460	0,73	mc. 0,007

11 x3-pannello sedile da tappezzare in plastica x3-seat panel for upholstery

code	finishing	q.kit	q.pack	a	b	kg.x1	vol.x1
132203-003	● nero/black	x1	20	400	410	0,60	mc. 0,003



X3

swivel/backrest and seat options

main component sizes

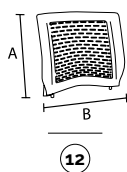

12 x3-schienale colorato a vista in plastica forato
x3-colored plastic back with holes

code	finishing	q.kit	q.pack	a	b	kg.x1	vol.x1
132105-019	○ bianco/white ral 1013	x1	10	400	460	0,90	mc. 0,008

and · **09** **10**

main component sizes

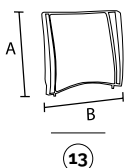

13 x3-schienale per rete nero a vista in plastica
x3-black plastic for mesh back

code	finishing	q.kit	q.pack	a	b	kg.x1	vol.x1
132103-014	● nero/black	x1	10	400	460	0,60	mc. 0,008

14 x3-liste a*b per schienale rete nere a vista
x3-black plastic strips a*b for mesh back

code	finishing	q.kit	q.pack	kg.x1	vol.x1
132103-013	● nero/black	x1	100	0,21	mc. 0,0004

15 x3-rete per schienale
x3-net for back

code	finishing	q.kit	q.pack	a	b	kg.x1	vol.x1
132103-029	● nero/black	x1	50	400	460	0,14	mc. 0,0057

16 vite truciolare tsp* d.3,5x10 brunita nera(per fissare schienale rete)
shaving screw tsp* d.3,5x10 zinc.(to fix mesh back)

code	finishing	q.kit
117803-105	● nero/black	x8

and · **09** **10** **11** **07**

X3

swivel w/armrests



plastic colours

- grigio/gray ral 7003
- nero/black
- rosso/red 527
- bianco/white ral 1013

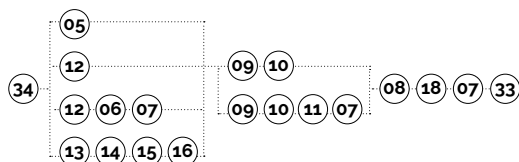

main component sizes

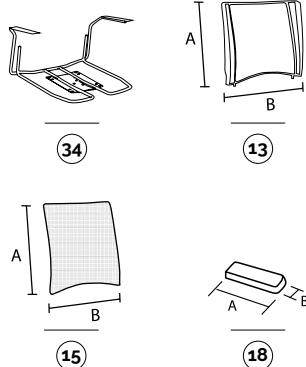

34 x3-telaio girevole a gas con braccioli
x3-swivel wire frame with arms d.12

code	finishing	q.kit	q.pack	kg.x1	vol.x1
110903-027	● nero/black	x1	100	4,00	mc. 0,02
110904-015	● grigio/gray	x1	100	4,00	mc. 0,02
110910-015	● cromato/chrome	x1	100	4,00	mc. 0,02

13 x3-schienale per rete nero a vista in plastica
x3-black plastic for mesh back

code	finishing	q.kit	q.pack	a	b	kg.x1	vol.x1
132103-014	● nero/black	x1	10	400	460	0,60	mc. 0,008

14 x3-liste a+b per schienale rete nere a vista
x3-black plastic strips a+b for mesh back

code	finishing	q.kit	q.pack	kg.x1	vol.x1
132103-013	● nero/black	x1	100	0,21	mc. 0,0004

15 x3-rete per schienale
x3-net for back

code	finishing	q.kit	q.pack	a	b	kg.x1	vol.x1
132103-029	● nero/black	x1	50	400	460	0,14	mc. 0,0057

16 vite trucciolare tsp+ d.3,5x10 brunita nera(per fissare schienale rete)
shaving screw tsp+ d.3,5x10 zinc.(to fix mesh back)

code	finishing	q.kit
117803-105	● nero/black	x8

18 x3-bracciolo plastica colorato per telaio filo
x3-colored plastic arm for wire frame

code	finishing	q.kit	q.pack	a	b	kg.x1	vol.x1
131703-019	● nero/black	x2	40	175	55	0,10	mc. 0,0004

07 vite hilo tb+ 5x12 cementata brunita nera
screw tb+fr.hilo 5x12 black burnished

code	finishing	q.kit seat	q.kit back
117803-154	● nero/black	x8	x6

for the components below, see previous pages

33 **08** **09** **10**



for all colour codes, see page 259

X3

swivel w/armrests/backrest and seat options

main component sizes

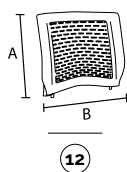

12 x3-schienale colorato a vista in plastica forato
x3-colored plastic back with holes

code	finishing	q.kit	q.pack	a	b	kg.x1	vol.x1
132104-019	● grigio/gray ral 7003	x1	10	400	460	0,90	mc. 0,008

and · **09** **10**

main component sizes

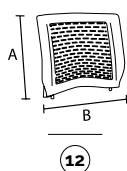

12 x3-schienale colorato a vista in plastica forato
x3-colored plastic back with holes

code	finishing	q.kit	q.pack	a	b	kg.x1	vol.x1
132105-019	○ bianco/white ral 1013	x1	10	400	460	0,90	mc. 0,008

06 x3-pannello schienale da tappezzare in plastica
x3-back panel for upholstery

code	finishing	q.kit	q.pack	a	b	kg.x1	vol.x1
132103-008	● nero/black	x1	20	350	385	0,50	mc. 0,003

11 x3-pannello sedile da tappezzare in plastica
x3-seat panel for upholstery

code	finishing	q.kit	q.pack	a	b	kg.x1	vol.x1
132203-003	● nero/black	x1	20	400	410	0,60	mc. 0,003

07 vite hilo tb+ 5x12 cementata brunita nera
screw tb+fr.hilo 5x12 black burnished

code	finishing	q.kit seat	q.kit back
117803-154	● nero/black	x8	x6

and · **09** **10**

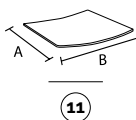
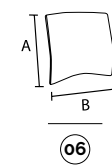

X3 bench



plastic colours

- grigio/gray ral 7003
- nero/black
- rosso/red 527
- bianco/white ral 1013

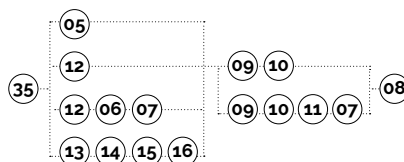

main component sizes

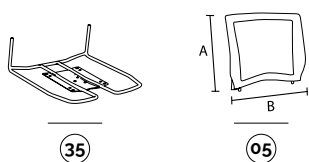

05

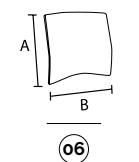

06

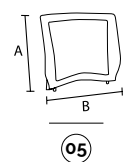

05

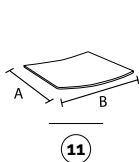

11

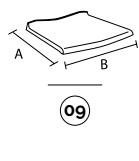

09

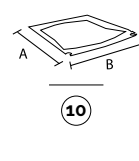

10

05 x3-telaio per panca x3-bench wire frame d.12

code	finishing	q.kit	q.pack	kg.x1	vol.x1
110703-041	● nero/black	x1	100	2,70	mc. 0,02
110704-039	● grigio/gray	x1	100	2,70	mc. 0,02

06 x3-schienale colorato a vista in plastica pieno x3-colored full plastic back

code	finishing	q.kit	q.pack	a	b	kg.x1	vol.x1
132103-090	● nero/black	x1	10	400	460	0,90	mc. 0,008

07 x3-pannello schienale da tappezzare in plastica x3-plastic panel for upholstery

code	finishing	q.kit	q.pack	a	b	kg.x1	vol.x1
132103-008	● nero/black	x1	20	350	385	0,50	mc. 0,003

08 vite hilo tb• 5x12 cementata brunita nera screw tb+fr.hilo 5x12 black burnished

code	finishing	q.kit seat	q.kit back
117803-154	● nero/black	x8	x6

09 x3-riduttore per schienale in plastica x3-plastic adapter for the back

code	finishing	q.kit	q.pack	kg.x1	vol.x1
132103-009	● nero/black	x2	200	0,019	mc. 0,0001

10 x3-sedile colorato a vista in plastica per telaio slitta x3-colored plastic seat for wire frame

code	finishing	q.kit	q.pack	a	b	kg.x1	vol.x1
132203-019	● nero/black	x1	10	450	460	1,20	mc. 0,015

11 x3-sottosedile colorato a vista in plastica x3-outer colored plastic seat

code	finishing	q.kit	q.pack	a	b	kg.x1	vol.x1
132203-009	● nero/black	x1	20	450	460	0,73	mc. 0,007

12 x3-pannello sedile da tappezzare in plastica x3-seat panel for upholstery

code	finishing	q.kit	q.pack	a	b	kg.x1	vol.x1
132203-003	● nero/black	x1	20	400	410	0,60	mc. 0,003

for the bench components, see page 417



for all colour codes, see page 259

X3

bench w/armrests



plastic colours

- grigio/gray ral 7003
- nero/black
- rosso/red 527
- bianco/white ral 1013

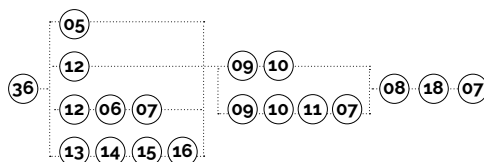

main component sizes

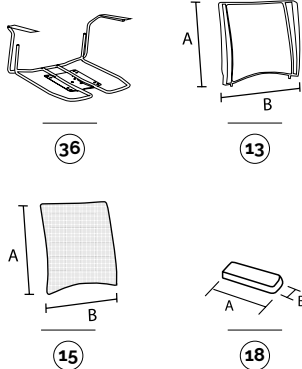

for the components below, see previous pages

08 09 10

for all colour codes, see page 259

optionals

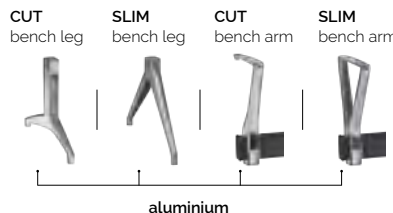
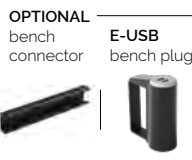

36	x3-telaio per panca con braccioli x3-bench wire frame d.12 with arms					
code	finishing	q.kit	q.pack	kg.x1	vol.x1	
110703-044	● nero/black	x1	100	3,60	mc. 0,02	
110704-210	● grigio/gray	x1	100	3,60	mc. 0,02	
110710-044	● cromato/chrome	x1	100	3,60	mc. 0,02	
13	x3-schienale per rete nero a vista in plastica x3-black plastic for mesh back					
code	finishing	q.kit	q.pack	a	b	kg.x1 vol.x1
132103-014	● nero/black	x1	10	400	460	0,60 mc. 0,008
14	x3-liste a+b per schienale rete nere a vista x3-black plastic strips a+b for mesh back					
code	finishing	q.kit	q.pack	kg.x1	vol.x1	
132103-013	● nero/black	x1	100	0,21	mc. 0,0004	
15	x3-rete per schienale x3-net for back					
code	finishing	q.kit	q.pack	a	b	kg.x1 vol.x1
132103-029	● nero/black	x1	50	400	460	0,14 mc. 0,0057
16	vite truccolare tsp+ d.3,5x10 brunita nera(per fissare schienale rete) shaving screw tsp+ d.3,5x10 zinc.(to fix mesh back)					
code	finishing	q.kit				
117803-105	● nero/black	x8				
18	x3-bracciolo plastica colorato per telaio filo x3-colored plastic arm for wire frame					
code	finishing	q.kit	q.pack	a	b	kg.x1 vol.x1
131702-019	● rosso/red 527	x2	40	175	55	0,10 mc. 0,0004
07	vite hilo tb+ 5x12 cementata brunita nera screw tb+fr.hilo 5x12 black burnished					
code	finishing	q.kit seat	q.kit back			
117803-154	● nero/black	x8	x6			

X3

bench w/armrests/backrest and seat options

main component sizes

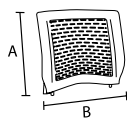

12



11



12 x3-schienale colorato a vista in plastica forato
x3-colored plastic back with holes

code	finishing	q.kit	q.pack	a	b	kg.x1	vol.x1
132104-019	● grigio/gray ral 7003	x1	10	400	460	0,90	mc. 0,008

11 x3-pannello sedile da tappezzare in plastica
x3-seat panel for upholstery

code	finishing	q.kit	q.pack	a	b	kg.x1	vol.x1
132203-003	● nero/black	x1	20	400	410	0,60	mc. 0,003

07 vite hilo tb+ 5x12 cementata brunita nera
screw tb+fr.hilo 5x12 black burnished

code	finishing	q.kit seat	q.kit back
117803-154	● nero/black	x8	x6

and - 09 10

main component sizes

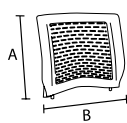

12

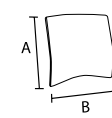

06

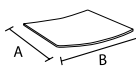

11



12 x3-schienale colorato a vista in plastica forato
x3-colored plastic back with holes

code	finishing	q.kit	q.pack	a	b	kg.x1	vol.x1
132105-019	○ bianco/white ral 1013	x1	10	400	460	0,90	mc. 0,008

06 x3-pannello schienale da tappezzare in plastica
x3-back panel for upholstery

code	finishing	q.kit	q.pack	a	b	kg.x1	vol.x1
132103-008	● nero/black	x1	20	350	385	0,50	mc. 0,003

11 x3-pannello sedile da tappezzare in plastica
x3-seat panel for upholstery

code	finishing	q.kit	q.pack	a	b	kg.x1	vol.x1
132203-003	● nero/black	x1	20	400	410	0,60	mc. 0,003

07 vite hilo tb+ 5x12 cementata brunita nera
screw tb+fr.hilo 5x12 black burnished

code	finishing	q.kit seat	q.kit back
117803-154	● nero/black	x8	x6

and - 09 10

X3

optional colour codes



plastic colour codes



12 schienale in plastica con fori
plastic backrest with holes

- 132104-019 grigio/gray ral 7003
- 132103-019 nero/black
- 132105-019 bianco/white ral 1013



05 schienale in plastica pieno
full plastic backrest

- 132103-090 nero/black

● rosso/red 527
Moq: 300pz/order



09 sedile in plastica per telaio slitta
plastic seat for wire frame

- 132204-019 grigio/gray ral 7003
- 132203-019 nero/black
- 132205-019 bianco/white ral 1013



26 sedile in plastica per telaio 4 gambe
plastic seat for 4-legs frame

- 132204-018 grigio/gray ral 7003
- 132203-018 nero/black
- 132205-018 bianco/white ral 1013



10 sottosedile in plastica
outer plastic seat

- 132204-009 grigio/gray ral 7003
- 132203-009 nero/black
- 132205-009 bianco/white ral 1013



18 bracciolo in plastica per telaio slitta
plastic arm for wire frame

- 131704-019 grigio/gray ral 7003
- 131703-019 nero/black
- 131705-019 bianco/white ral 1013



20 bracciolo in plastica per telaio slitta con tavoletta
plastic arm for wire frame with tablet

- 131704-018 grigio/gray ral 7003
- 131703-018 nero/black
- 131705-018 bianco/white ral 1013



28 bracciolo in plastica per telaio 4 gambe
plastic arm for 4-legs frame

- 131704-017 grigio/gray ral 7003
- 131703-017 nero/black
- 131705-017 bianco/white ral 1013



30 bracciolo in plastica per telaio 4 gambe con tavoletta
plastic arm for 4-legs frame with tablet

- 131704-014 grigio/gray ral 7003
- 131703-014 nero/black
- 131705-014 bianco/white ral 1013



aria



discover more about
Aria Collection

Aria la panca versatile.
Resistente, funzionale e adattabile ad ogni situazione grazie alla scocca interamente in metallo, verniciata in nero o grigio.
Possibilità di massimizzare comodità e stile grazie ai nuovi pannelli imbottiti opzionabili per schienale e seduta.

Aria è perfetta per arredare sale d'aspetto e spazi sia pubblici sia privati.

*Aria: the versatile bench.
Durable, functional and easy to adapt to any setting thanks to the all-metal body, painted in black or grey.
Possibility to enhance comfort and style thanks to the new optional padded panels for the back and seat.*

Aria is perfect for furnishing waiting rooms as well as public and private spaces.

Plus

- Facile da pulire.
- Massima comodità grazie ai nuovi pannelli imbottiti opzionabili.
- Facile da tappezzare e da assemblare.
- Certificazione EN 16139:2013+AC2013 Livello 2.
- Certificazione EN 15373:2017 Livello 3.
- Easy to clean.
- New optional padded panels ensure maximum comfort.
- Easy to upholster and assemble.
- EN 16139:2013+AC2013 Level 2 Certification.
- EN 15373:2017 Level 3 Certification.



designed by:
R&D Alba



**certified
product**

aria

bench

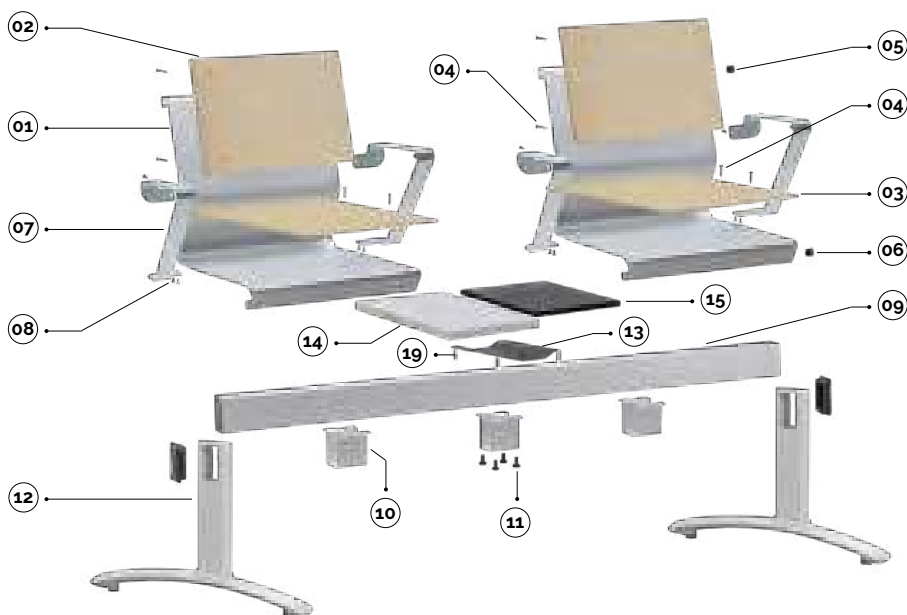
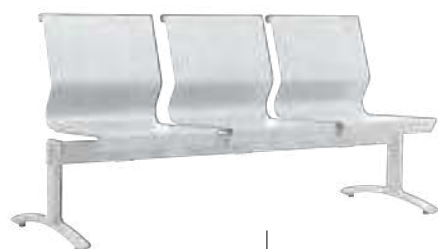

CERTIFIED BY
CATAS

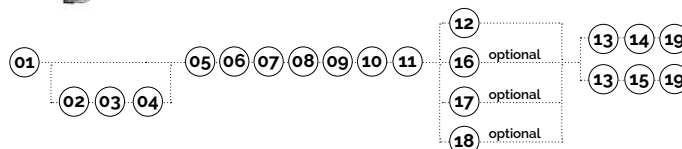

01 aria-scocca intera in lamiera
aria-shell metal sheet

code	finishing	q.kit	q.pack	a	b	kg.x1	vol.x1
110703-065	● nero/black	x1	25	475	490	9,86	mc. 0.02
110703-066	● nero/black fori x bracc./holes for arms	x1	25	475	490	9,86	mc. 0.02
110704-025	● grigio/grey	x1	25	475	490	9,86	mc. 0.02
110704-027	● grigio/grey fori x bracc./holes for arms	x1	25	475	490	9,86	mc. 0.02

02 aria-shl-pannello schienale in legno
aria-shl-plywood back panel for upholstery

code	finishing	q.kit	q.pack	a	b	kg.x1	vol.x1
122107-007	● faggio/plywood	x1	20	430	245	0,45	mc. 0.00225

03 aria-sdl-pannello sedile in legno
aria-sdl-plywood seat panel for upholstery

code	finishing	q.kit	q.pack	a	b	kg.x1	vol.x1
122207-007	● faggio/plywood	x1	20	430	420	0,735	mc. 0.00225

04 vite tbei m4x8 zincata bianca
screw tbei m4x8 white zinc

code	finishing	q.kit
117703-126	○ zincata bianca/white zinc	x4

05 tappo copritesta ovale 40x20 testa cromata
cover head 40x20 oval chrome

code	finishing	q.kit
134110-001	● cromato/chrome	x2

06 tappo copritesta d.20 testa cromata
cover head d.20 chrome

code	finishing	q.kit
134110-200	● cromato/chrome	x2

07 aria-bracciolo in metallo per scocca
aria-metal arm for shell

code	finishing	q.kit	q.pack	a	b	kg.x1	vol.x1
111703-001	● nero/black destro/right	x1	5	300	270	1,68	mc. 0.02
111703-002	● nero/black sinistro/left	x1	5	300	270	1,68	mc. 0.02
111704-001	● grigio/grey destro/right	x1	5	300	270	1,68	mc. 0.02
111704-002	● grigio/grey sinistro/left	x1	5	300	270	1,68	mc. 0.02

08 vite testa bombata esagono incassato m6x14 zincata
screw m6x14 head hexagon embedded zinc

code	finishing	q.kit
117711-185	○ zincata/zinc	x3

09 got(03) trave per panca 80x40
got(03) beam for bench 80x40

code	finishing	q.kit	q.pack	a	b	c	kg.x1	vol.x1
110703-190	● nero/black 2 posti / 2 seats	x1	1	1160	80	40	3,20	mc. 0.0045
110704-090	● grigio/grey 2 posti / 2 seats	x1	1	1160	80	40	3,20	mc. 0.0045
110703-191	● nero/black 3 posti / 3 seats	x1	1	1710	80	40	4,71	mc. 0.005
110704-091	● grigio/grey 3 posti / 3 seats	x1	1	1710	80	40	4,71	mc. 0.005
110703-192	● nero/black 4 posti / 4 seats	x1	1	2260	80	40	6,22	mc. 0.0085
110704-092	● grigio/grey 4 posti / 4 seats	x1	1	2260	80	40	6,22	mc. 0.0085
110703-193	● nero/black 5 posti / 5 seats	x1	1	2800	80	40	7,72	mc. 0.01
110704-193	● grigio/grey 5 posti / 5 seats	x1	1	2800	80	40	7,72	mc. 0.01

10 gocv-cavalotto sotto trave
gocv-support under beam

code	finishing	q.kit	q.pack	a	b	kg.x1	vol.x1
110703-007	● nero/black	x1	50	55	65	0,60	mc. 0.0005
110704-016	● grigio/grey	x1	50	55	65	0,60	mc. 0.0005

11 confezione viti m8x12 testa cilindrica a esagono incassato brunita nera
screws m8x12 cylindrical head hexagon embedded burnishing black package

code	finishing	q.kit	q.pack
117003-070	● nero/black	x4	200

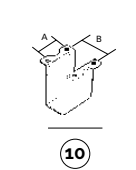
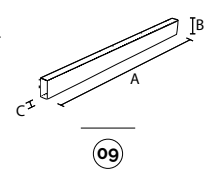
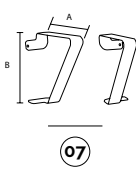
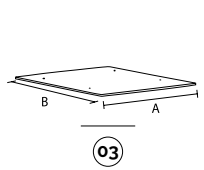
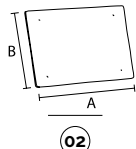
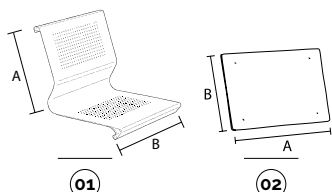

main component sizes

for the bench components, see page 417

aria

bench leg options

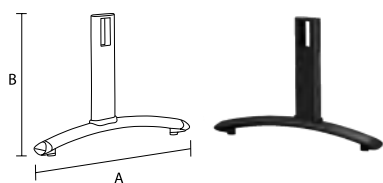

12 91gm-gamba mobile per panca con accessori
91gm-movable leg for bench with accessories

code	finishing	q.kit	q.pack	a	b	kg.x1	vol.x1
110703-581	● nero/black	x2	2	620	376	2,7	mc. 0,03
110704-581	● grigio/grey I G2621	x2	2	620	376	2,7	mc. 0,03
110704-582	● grigio/grey drylac	x2	2	620	376	2,7	mc. 0,03
110705-581	○ bianco/white ral 9010	x2	2	620	376	2,7	mc. 0,03
110710-581	● cromato/chrome	x2	2	620	376	2,7	mc. 0,03

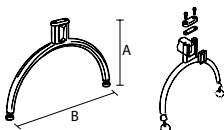

16 100gm-gamba mobile per panca con accessori
100gm-movable leg for bench with accessories

code	finishing	q.kit	q.pack	a	b	kg.x1	vol.x1
110703-008	● nero/black	x2	2	380	600	2,10	mc. 0,012
110704-004	● grigio/grey	x2	2	380	600	2,10	mc. 0,012
110710-005	● cromato/chrome	x2	2	380	600	2,10	mc. 0,012

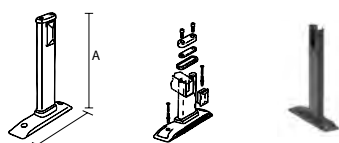

17 90gf-gamba fissa per panca con accessori
90gf-fixed leg for bench with accessories

code	finishing	q.kit	q.pack	a	b	kg.x1	vol.x1
110703-030	● nero/black	x2	2	380	310	1,90	mc. 0,006
110704-011	● grigio/grey	x2	2	380	310	1,90	mc. 0,006

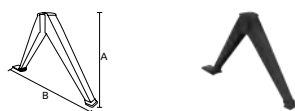

18 200gm-gamba mobile per panca con accessori
200gm-movable leg for bench with accessories

code	finishing	q.kit	q.pack	a	b	kg.x1	vol.x1
110703-110	● nero/black	x2	2	380	600	2,60	mc. 0,005
110704-112	● grigio/grey	x2	2	380	600	2,60	mc. 0,005
110710-110	● cromato/chrome	x2	2	380	600	2,60	mc. 0,005

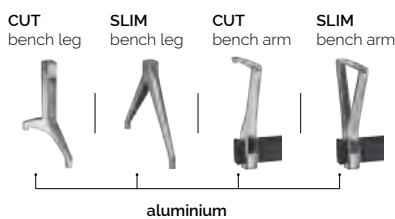
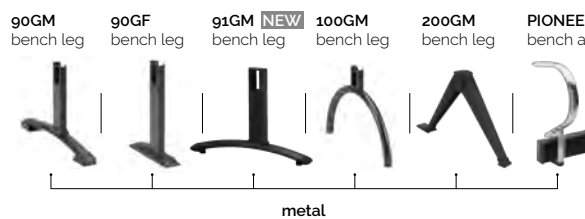

bench table options

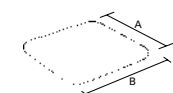
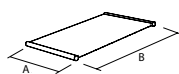

13 90ap-attacco porta piano
90ap-table attachment

code	finishing	q.kit	q.pack	a	b	c	d	kg.x1	vol.x1
110703-014	● nero/black	x1	25	170	200	65	55	1,00	mc. 0,002
110704-019	● grigio/grey	x1	25	170	200	65	55	1,00	mc. 0,002

14 aria-tavolo per panca in lamiera
aria-metal sheet for bench

code	finishing	q.kit	q.pack	a	b	kg.x1	vol.x1
110703-069	● nero/black	x1	25	370	500	5,50	mc. 0,01
110704-030	● grigio/grey	x1	25	370	500	5,50	mc. 0,01

15 90tn-piano tavolo per panca
90tn-table for bench

code	finishing	q.kit	q.pack	a	b	kg.x1	vol.x1
120303-001	● nero/black	x1	10	400	400	2,20	mc. 0,002

19 vite tc+ m6x12 brunita nera
screw tc+ m6x12 burnishing black

code	finishing	q.kit
117703-177	● nero/black	x4

aria

bench cut & slim version

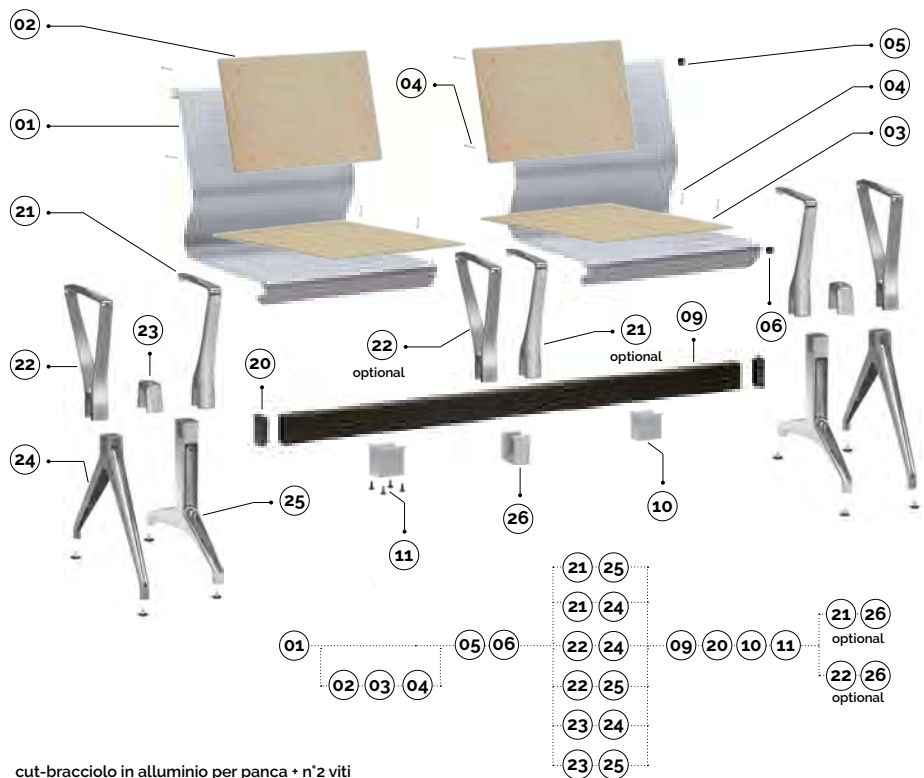

(21) cut-bracciolo in alluminio per panca + n°2 viti
cut-aluminium arm for bench + n°2 screws

code	finishing	q.kit	q.pack	a	b	kg.x1	vol.x1
111704-223	● alluminio/aluminium	x1	10	300	305	1,48	mc. 0,0011

(22) slim-bracciolo in alluminio per panca + n°2 viti
slim-aluminium arm for bench + n°2 screws

code	finishing	q.kit	q.pack	a	b	kg.x1	vol.x1
111704-225	● alluminio/aluminium	x1	10	325	305	1,35	mc. 0,0011

(23) cut/slim-cavallotto in alluminio per gamba panca + n°2 viti
cut/slim-aluminium bracket 80x40 for bench leg + n°2 screws

code	finishing	q.kit	q.pack	a	b	kg.x1	vol.x1
111704-222	● alluminio/aluminium	x1	10	60	95	0,30	mc. 0,0012

(24) slim-gamba in alluminio per gamba panca + n°2 piedini
slim-aluminium leg for bench + n°2 glides

code	finishing	q.kit	q.pack	a	b	kg.x1	vol.x1
111704-226	● alluminio/aluminium	x2	5	610	350	1,15	mc. 0,014

(25) cut-gamba in alluminio per gamba panca + n°2 piedini
cut-aluminium leg for bench + n°2 glides

code	finishing	q.kit	q.pack	a	b	kg.x1	vol.x1
111704-224	● alluminio/aluminium	x2	5	610	350	2,55	mc. 0,014

(20) tappo copritesta rettangolare 80x40 nero
rectangular cover head cap 80x40 black

code	finishing	q.kit
134103-001	● nero/black	x2

(09) got(03) trave per panca 80x40
got(03) beam for bench 80x40

code	finishing		q.kit	q.pack	a	b	c	kg.x1	vol.x1
110703-190	● nero/black	2 posti / 2 seats	x1	1	1160	80	40	3,20	mc. 0,0045
110704-090	● grigio/grey	2 posti / 2 seats	x1	1	1160	80	40	3,20	mc. 0,0045
110703-191	● nero/black	3 posti / 3 seats	x1	1	1710	80	40	4,71	mc. 0,005
110704-091	● grigio/grey	3 posti / 3 seats	x1	1	1710	80	40	4,71	mc. 0,005
110703-192	● nero/black	4 posti / 4 seats	x1	1	2260	80	40	6,22	mc. 0,0085
110704-092	● grigio/grey	4 posti / 4 seats	x1	1	2260	80	40	6,22	mc. 0,0085
110703-193	● nero/black	5 posti / 5 seats	x1	1	2800	80	40	7,72	mc. 0,01
110704-193	● grigio/grey	5 posti / 5 seats	x1	1	2800	80	40	7,72	mc. 0,01

(10) gocv-cavallotto sotto trave
gocv-support under beam

code	finishing	q.kit	q.pack	a	b	kg.x1	vol.x1
110703-007	● nero/black	x1	50	55	65	0,60	mc. 0,0005
110704-016	● grigio/grey	x1	50	55	65	0,60	mc. 0,0005

(11) confezione viti m8x12 testa cilindrica a esagono incassato brunita nera
screws m8x12 cylindrical head hexagon embedded burnishing black package

code	finishing	q.kit	q.pack
117003-070	● nero/black	x4	200

(26) cut/slim-cavallotto in alluminio per bracciolo panca
cut/slim-aluminium bracket 80x40 for bench arm

code	finishing	q.kit	q.pack	a	b	kg.x1	vol.x1
111704-221	● alluminio/aluminium	x1	10	58	95	0,27	mc. 0,0012

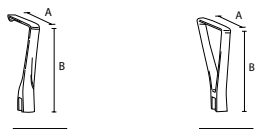

(21)

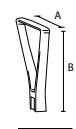

(22)



(24)

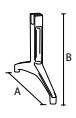

(25)

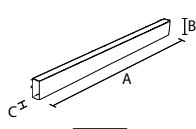

(09)

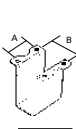

(10)

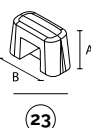

(23)

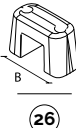

(26)

for the components below, see previous pages

(01) (02) (03) (04) (05) (06)

for the bench components, see page 417

OPTIONAL
bench
connector



E-USB
bench plug



JIM
bench leg



plastic

90GM
bench leg



90GF
bench leg



91GM **NEW**
bench leg



100GM
bench leg



200GM
bench leg



PIONEER
bench arm



metal

CUT
bench leg



SLIM
bench leg



CUT
bench arm



SLIM
bench arm



aluminium

main component sizes

optionals





nexus



discover more about
Nexus Collection

La panca interamente in metallo.
Un pezzo unico, dal design essenziale,
che garantisce una seduta comoda e
molto stabile. Completano la famiglia i
telai impilabili 4 gambe e slitta.

Nexus è ideale per tutti gli ambienti
Community e le Waiting Area.

*The all-metal bench.
A unique piece, with an essential design,
which guarantees a comfortable
and very stable seat. The family is
completed by the stackable 4-legged
and sled frames.*

*Nexus is ideal for all Community
environments and Waiting Areas.*

Plus

- Struttura innovativa, sviluppata in un unico pezzo e interamente in metallo.
- Design distintivo, grazie soprattutto alla scocca traforata, interamente in metallo e disponibile in 4 finiture.
- Funzionale e facile da pulire.
- Certificazione EN 16139:2013+AC2013 Livello 2.
- *Innovative structure, developed in one piece and entirely in metal.*
- *Distinctive design, thanks above all to the perforated seat shell, made entirely in metal and available in 4 finishes.*
- *Easy to upholster and assemble.*
- *EN 16139:2013+AC2013 Level 2 Certification.*



designed by:
**Esedra &
Alessandro Crosera & partners**



**trolley
available**



**certified
product**

nexus

bench

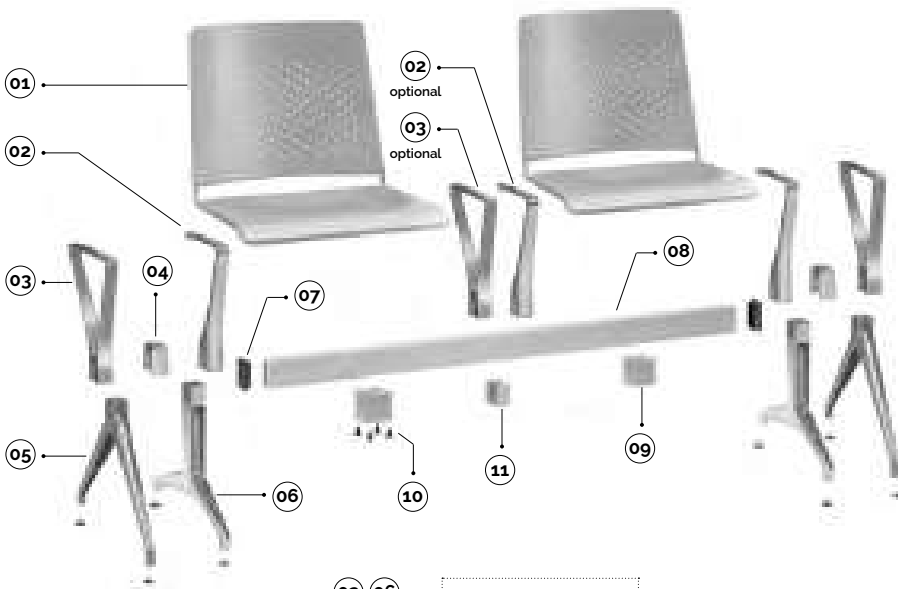
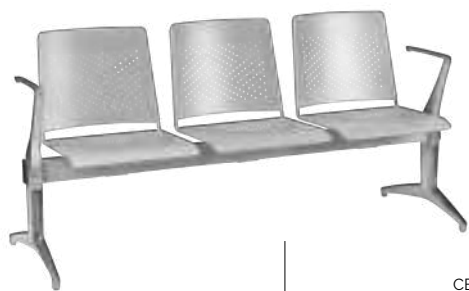

CERTIFIED BY
CATAS

Corten • *Specifica caratteristica del Corten è la variabilità nella tonalità della finitura.
* A specific characteristic of Corten is the variability in the tone of the finish.

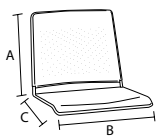

01

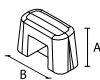

04

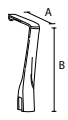

02

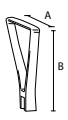

03

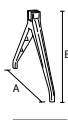

05

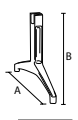

06

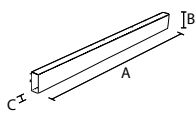

08



09

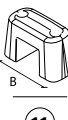

11

01 nexus-scocca in lamiera
nexus-shell metal sheet

code	finishing	q.kit	q.pack	a	b	c	kg.x1	vol.x1
110703-220	● nero/black	x1	60	405	454	545	7,60	mc. 0.02
110704-220	● grigio/grey	x1	60	405	454	545	7,60	mc. 0.02
110705-220	○ bianco/white ral9010	x1	60	405	454	545	7,60	mc. 0.02
110707-220	● corten*	x1	60	405	454	545	7,60	mc. 0.02

02 cut-bracciolo in alluminio per panca + n'2 viti
cut-aluminium arm for bench + n'2 screws

code	finishing	q.kit	q.pack	a	b	kg.x1	vol.x1
111704-223	● alluminio/aluminium	x1	10	300	305	1,40	mc. 0.0011

03 slim-bracciolo in alluminio per panca + n'2 viti
slim-aluminium arm for bench + n'2 screws

code	finishing	q.kit	q.pack	a	b	kg.x1	vol.x1
111704-225	● alluminio/aluminium	x1	10	325	305	1,40	mc. 0.0011

04 cut/slim-cavallotto in alluminio per gamba panca + n'2 viti
cut/slim-aluminium bracket 80x40 for bench leg + n'2 screws

code	finishing	q.kit	q.pack	a	b	kg.x1	vol.x1
111704-222	● alluminio/aluminium	x1	10	60	95	0,40	mc. 0.0012

05 slim-gamba in alluminio per gamba panca + n'2 piedini
slim-aluminium leg for bench + n'2 glides

code	finishing	q.kit	q.pack	a	b	kg.x1	vol.x1
111704-226	● alluminio/aluminium	x2	5	610	350	1,20	mc. 0.014

06 cut-gamba in alluminio per gamba panca + n'2 piedini
cut-aluminium leg for bench + n'2 glides

code	finishing	q.kit	q.pack	a	b	kg.x1	vol.x1
111704-224	● alluminio/aluminium	x2	5	610	350	2,55	mc. 0.014

07 tappo copritesta rettangolare 80x40 nero
rectangular cover head cap 80x40 black

code	finishing	q.kit
134103-001	● nero/black	x2

08 got(03) trave per panca 80x40
got(03) beam for bench 80x40

code	finishing	q.kit	q.pack	a	b	c	kg.x1	vol.x1	
110703-190	● nero/black	2 posti / 2 seats	x1	1	1160	80	40	3,20	mc. 0.0045
110704-090	● grigio/grey	2 posti / 2 seats	x1	1	1160	80	40	3,20	mc. 0.0045
110703-191	● nero/black	3 posti / 3 seats	x1	1	1710	80	40	4,71	mc. 0.005
110704-091	● grigio/grey	3 posti / 3 seats	x1	1	1710	80	40	4,71	mc. 0.005
110703-192	● nero/black	4 posti / 4 seats	x1	1	2260	80	40	6,22	mc. 0.0085
110704-092	● grigio/grey	4 posti / 4 seats	x1	1	2260	80	40	6,22	mc. 0.0085
110703-193	● nero/black	5 posti / 5 seats	x1	1	2800	80	40	7,72	mc. 0.01
110704-193	● grigio/grey	5 posti / 5 seats	x1	1	2800	80	40	7,72	mc. 0.01

09 90cv-cavallotto sotto trave
90cv-support under beam

code	finishing	q.kit	q.pack	a	b	kg.x1	vol.x1
110703-007	● nero/black	x1	50	55	65	0,60	mc. 0.0005
110704-016	● grigio/grey	x1	50	55	65	0,60	mc. 0.0005

10 confezione viti m8x12 testa cilindrica a esagono incassato brunita nera
screws m8x12 cylindrical head hexagon embedded burnishing black package

code	finishing	q.kit	q.pack
117003-070	● nero/black	x4	200

11 cut/slim-cavallotto in alluminio per bracciolo panca
cut/slim-aluminium bracket 80x40 for bench arm

code	finishing	q.kit	q.pack	a	b	kg.x1	vol.x1
111704-221	● alluminio/aluminium	x1	10	58	95	0,32	mc. 0.0012

main component sizes

for the bench components, see page 417

nexus

bench leg options

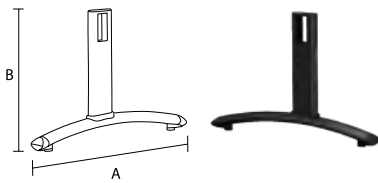

12 91gm-gamba mobile per panca con accessori
91gm-movable leg for bench with accessories

code	finishing	q.kit	q.pack	a	b	kg.x1	vol.x1
110703-581	● nero/black	x2	2	620	376	2,7	mc. 0.03
110704-581	● grigio/grey I G2621	x2	2	620	376	2,7	mc. 0.03
110704-582	● grigio/grey drylac	x2	2	620	376	2,7	mc. 0.03
110705-581	○ bianco/white ral 9010	x2	2	620	376	2,7	mc. 0.03
110710-581	● cromato/chrome	x2	2	620	376	2,7	mc. 0.03

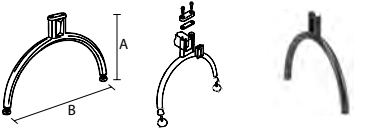

13 100gm-gamba mobile per panca con accessori
100gm-movable leg for bench with accessories

code	finishing	q.kit	q.pack	a	b	kg.x1	vol.x1
110703-008	● nero/black	x2	2	380	600	2,10	mc. 0.012
110704-004	● grigio/grey	x2	2	380	600	2,10	mc. 0.012
110710-005	● cromato/chrome	x2	2	380	600	2,10	mc. 0.012

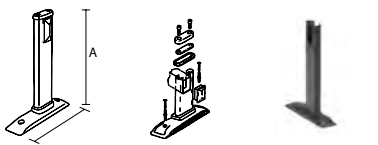

14 90gf-gamba fissa per panca con accessori
90gf-fixed leg for bench with accessories

code	finishing	q.kit	q.pack	a	b	kg.x1	vol.x1
110703-030	● nero/black	x2	2	380	310	1,90	mc. 0.006
110704-011	● grigio/grey	x2	2	380	310	1,90	mc. 0.006



15 200gm-gamba mobile per panca con accessori
200gm-movable leg for bench with accessories

code	finishing	q.kit	q.pack	a	b	kg.x1	vol.x1
110703-110	● nero/black	x2	2	380	600	2,60	mc. 0.005
110704-112	● grigio/grey	x2	2	380	600	2,60	mc. 0.005
110710-110	● cromato/chrome	x2	2	380	600	2,60	mc. 0.005

optionals

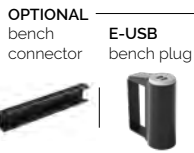

plastic

metal

aluminium

bench sizes

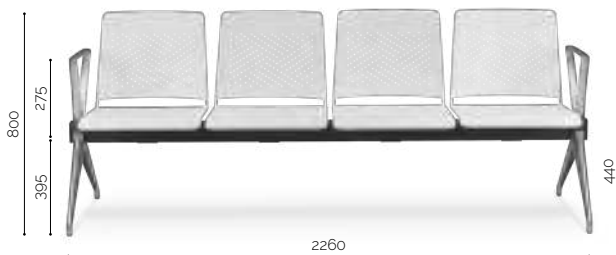
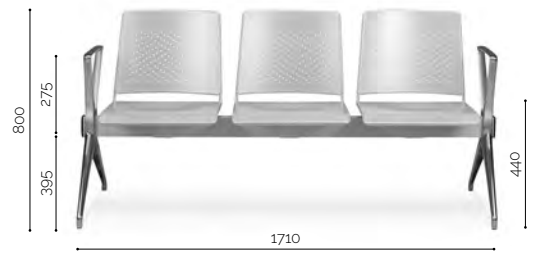
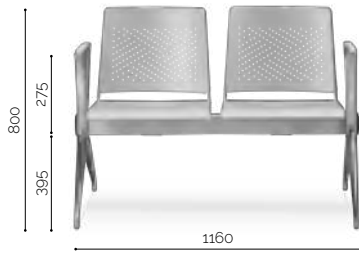

nexus

bench

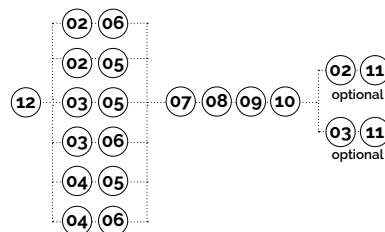
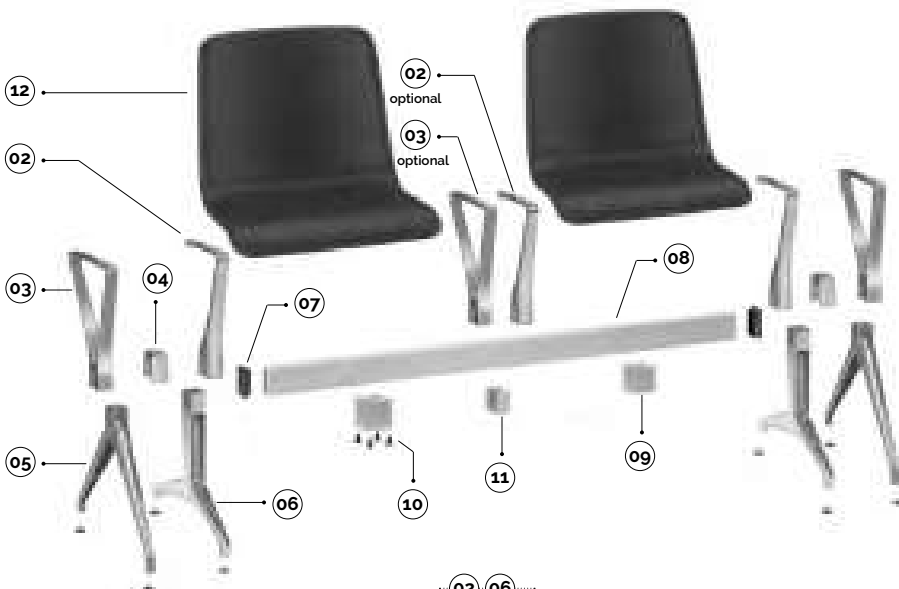

Disponibile in diversi colori mono/bi-colour per lotti da 100 pezzi

12 Available in different colours mono/bi-colour for batches from 100 pcs

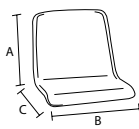

12

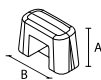

04



03



02

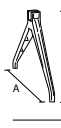

05

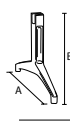

06

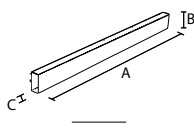

07



08

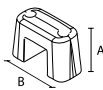

09



11

main component sizes

for the bench components, see page 417

12 **nexus-scocca in poliuretano morbido freeform advanced**
nexus-half-soft polyurethane freeform advanced shell model

code	finishing	q.kit	q.pack	a	b	c	kg.x1	vol.x1
133903-061	● nero/black	x1		410	485	430	7,60	mc. 0.09

02 **cut-bracciolo in alluminio per panca + n'2 viti**
cut-aluminium arm for bench + n'2 screws

code	finishing	q.kit	q.pack	a	b	kg.x1	vol.x1
111704-223	● alluminio/aluminium	x1	10	300	305	1,40	mc. 0.0011

03 **slim-bracciolo in alluminio per panca + n'2 viti**
slim-aluminium arm for bench + n'2 screws

code	finishing	q.kit	q.pack	a	b	kg.x1	vol.x1
111704-225	● alluminio/aluminium	x1	10	325	305	1,40	mc. 0.0011

04 **cut/slim-cavallotto in alluminio per gamba panca + n'2 viti**
cut/slim-aluminium bracket 80x40 for bench leg + n'2 screws

code	finishing	q.kit	q.pack	a	b	kg.x1	vol.x1
111704-222	● alluminio/aluminium	x1	10	60	95	0,40	mc. 0.0012

05 **slim-gamba in alluminio per gamba panca + n'2 piedini**
slim-aluminium leg for bench + n'2 glides

code	finishing	q.kit	q.pack	a	b	kg.x1	vol.x1
111704-226	● alluminio/aluminium	x2	5	610	350	1,20	mc. 0.014

06 **cut-gamba in alluminio per gamba panca + n'2 piedini**
cut-aluminium leg for bench + n'2 glides

code	finishing	q.kit	q.pack	a	b	kg.x1	vol.x1
111704-224	● alluminio/aluminium	x2	5	610	350	2,55	mc. 0.014

07 **tappo copritesta rettangolare 80x40 nero**
rectangular cover head cap 80x40 black

code	finishing	q.kit
134103-001	● nero/black	x2

08 **got(03) trave per panca 80x40**
got(03) beam for bench 80x40

code	finishing		q.kit	q.pack	a	b	c	kg.x1	vol.x1
110703-190	● nero/black	2 posti / 2 seats	x1	1	1160	80	40	3,20	mc. 0.0045
110704-090	● grigio/grey	2 posti / 2 seats	x1	1	1160	80	40	3,20	mc. 0.0045
110703-191	● nero/black	3 posti / 3 seats	x1	1	1710	80	40	4,71	mc. 0.005
110704-091	● grigio/grey	3 posti / 3 seats	x1	1	1710	80	40	4,71	mc. 0.005
110703-192	● nero/black	4 posti / 4 seats	x1	1	2260	80	40	6,22	mc. 0.0085
110704-092	● grigio/grey	4 posti / 4 seats	x1	1	2260	80	40	6,22	mc. 0.0085
110703-193	● nero/black	5 posti / 5 seats	x1	1	2800	80	40	7,72	mc. 0.01
110704-193	● grigio/grey	5 posti / 5 seats	x1	1	2800	80	40	7,72	mc. 0.01

09 **gocv-cavallotto sotto trave**
gocv-support under beam

code	finishing	q.kit	q.pack	a	b	kg.x1	vol.x1
110703-007	● nero/black	x1	50	55	65	0,60	mc. 0.0005
110704-016	● grigio/grey	x1	50	55	65	0,60	mc. 0.0005

10 **confezione viti m8x12 testa cilindrica a esagono incassato brunita nera**
screws m8x12 cylindrical head hexagon embedded burnishing black package

code	finishing	q.kit	q.pack
117003-070	● nero/black	x4	200

11 **cut/slim-cavallotto in alluminio per bracciolo panca**
cut/slim-aluminium bracket 80x40 for bench arm

code	finishing	q.kit	q.pack	a	b	kg.x1	vol.x1
111704-221	● alluminio/aluminium	x1	10	58	95	0,32	mc. 0.0012

nexus

polyurethane color options



PARTE ESTERNA - EXTERNAL PART

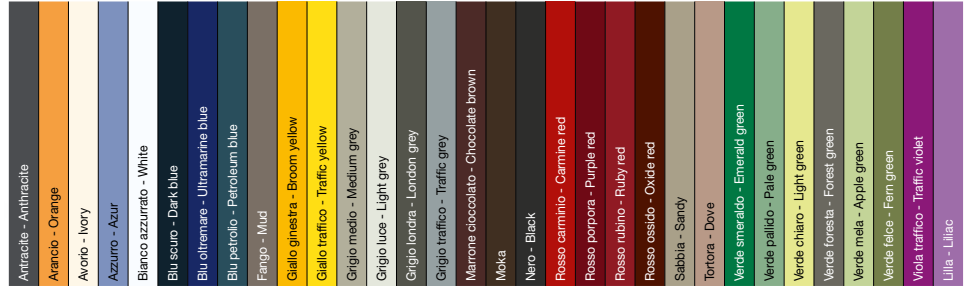

PARTE INTERNA - INNER PART	Antracite - Anthracite	Arancio - Orange	Avorio - Ivory	Azzurro - Azur	Bianco azzurrato - White	Blu scuro - Dark blue	Blu oltremare - Ultramarine blue	Blu petrolio - Petroleum blue	Fango - Mud	Giallo ginestra - Broom yellow	Giallo traffico - Traffic yellow	Grigio medio - Medium grey	Grigio luce - Light grey	Grigio Londra - London grey	Grigio traffico - Traffic grey	Marrone cioccolato - Chocolate brown	Moka	Nero - Black	Rosso carminio - Carmine red	Rosso porpora - Purple red	Rosso rubino - Ruby red	Rosso ossido - Oxide red	Sabbia - Sandy	Tortora - Dove	Verde smeraldo - Emerald green	Verde pallido - Pale green	Verde chiaro - Light green	Verde foresta - Forest green	Verde mela - Apple green	Verde felce - Fern green	Viola traffico - Traffic violet	Lilla - Lilac				
Antracite - Anthracite	•					•	•	•											•																	
Arancio - Orange	•	•				•	•	•											•																	
Avorio - Ivory	•	•	•	•		•	•	•	•	•	•		•						•	•	•	•	•	•	•	•	•	•	•	•	•	•	•	•	•	
Azzurro - Azur	•			•		•	•	•											•																	
Bianco azzurrato - White	•	•		•	•	•	•	•	•	•	•		•						•	•	•	•	•	•	•	•	•	•	•	•	•	•	•	•	•	
Blu scuro - Dark blue	•					•	•	•											•																	
Blu oltremare - Ultramarine blue	•					•	•	•											•																	
Blu petrolio - Petroleum blue	•					•	•	•											•																	
Fango - Mud	•					•	•	•	•				•						•			•														
Giallo ginestra - Broom yellow	•			•		•	•	•	•	•	•		•						•	•	•	•	•	•	•	•	•	•	•	•	•	•	•	•	•	
Giallo traffico - Traffic yellow	•					•	•	•			•								•																	
Grigio medio - Medium grey	•					•	•	•				•							•																	
Grigio luce - Light grey	•	•		•		•	•	•	•	•	•		•	•	•	•	•	•	•	•	•	•	•	•	•	•	•	•	•	•	•	•	•	•	•	
Grigio Londra - London grey	•					•	•	•											•																	
Grigio traffico - Traffic grey	•					•	•	•											•																	
Marrone cioccolato - Chocolate brown	•					•	•	•											•																	
Moka	•					•	•	•											•																	
Nero - Black	•					•	•	•											•																	
Rosso carminio - Carmine red	•					•	•	•											•																	
Rosso porpora - Purple red	•					•	•	•											•																	
Rosso rubino - Ruby red	•					•	•	•											•																	
Rosso ossido - Oxide red	•					•	•	•											•																	
Sabbia - Sandy	•		•			•	•	•	•			•							•	•	•	•	•	•	•	•	•	•	•	•	•	•	•	•	•	•
Tortora - Dove	•					•	•	•											•																	
Verde smeraldo - Emerald green	•					•	•	•											•																	
Verde pallido - Pale green	•					•	•	•											•																	
Verde chiaro - Light green	•					•	•	•											•																	
Verde foresta - Forest green	•					•	•	•											•																	
Verde mela - Apple green	•					•	•	•											•																	
Verde felce - Fern green	•					•	•	•											•																	
Viola traffico - Traffic violet	•					•	•	•											•																	
Lilla - Lilac	•					•	•	•											•																	•

COLORI - COLOURS

Antracite Anthracite	Simil RAL 7024
Arancio Orange	Simil PANT 7577/C
Avorio Ivory	Simil RAL 1013
Azzurro Azur	Simil PANT. 646/C
Bianco azzurrato White	Simil RAL 9016
Blu scuro Dark blue	Simil RAL 5008
Blu oltremare Ultramarine blue	RAL 5002
Blu petrolio Petroleum blue	PANT. 7477/C
Fango Mud	Simil PANT. 404/C

Giallo ginestra Broom yellow	RAL 1032
Giallo traffico Traffic yellow	RAL 1023
Grigio medio Medium grey	Simil PANT. 424/C
Grigio luce Light grey	RAL 7035
Grigio Londra London grey	Simil PANT. 418/C
Grigio traffico Traffic grey	Simil RAL 7042
Marrone cioccolato Chocolate brown	RAL 8017
Moka	Simil RAL 8019
Nero Black	RAL 9005

Rosso carminio Carmine red	RAL 3002
Rosso porpora Purple red	RAL 3004
Rosso rubino Ruby red	RAL 3003
Rosso ossido Oxide red	RAL 3009
Sabbia Sandy	Simil PANT. 7536/C
Tortora Dove	RAL 1019
Verde smeraldo Emerald green	RAL 6001
Verde pallido Pale green	RAL 6021
Verde chiaro Light green	RAL 6019

Verde foresta Forest green	PANT. 417/C
Verde mela Apple green	Simil PANT. 585/U
Verde felce Fern green	RAL 6025
Viola traffico Traffic violet	RAL 4006
Lilla Lilac	RAL 4005

quantità minima ordine: 100 pz. per colore
minimum order: 100 pieces per colour

nexus

4-legs

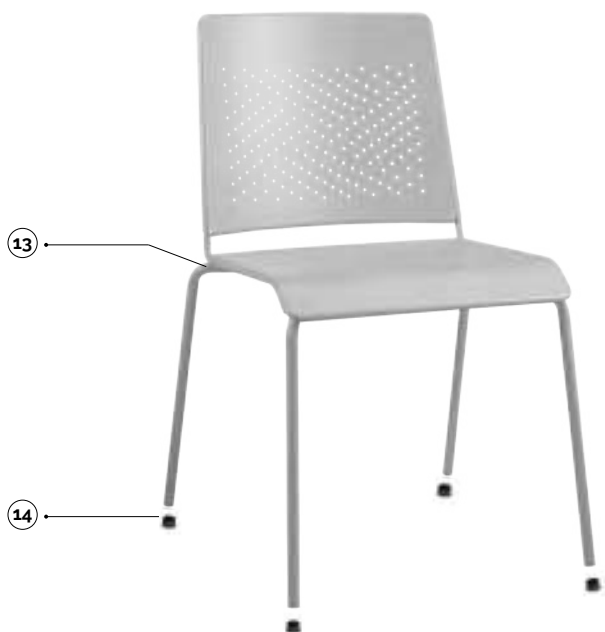

Corten ● *Specifica caratteristica del Corten è la variabilità nella tonalità della finitura.
* A specific characteristic of Corten is the variability in the tone of the finish.

13 14

main component sizes

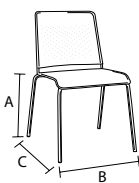

13

13 nexus-telaio 4 gambe con scocca in lamiera
nexus-4 legs frame with shell metal sheet

code	finishing	q.kit	q.pack	a	b	c	kg.x1	vol.x1
112603-070	● nero/black	x1	50	450	530	540	9,80	mc. 0,04
112604-070	● grigio/grey	x1	50	450	530	540	9,80	mc. 0,04
112605-070	○ bianco/white ral9010	x1	50	450	530	540	9,80	mc. 0,04
112607-070	● corten*	x1	50	450	530	540	9,80	mc. 0,04

14 puntale alettato tondo d.18 nero
inner cap for legs d.18 black

code	finishing	q.kit	q.pack
137003-072	● nero/black	x4	200



nexus-carrello portasedie con accessori nero
nexus-trolley for chairs with accessories black

code	finishing	q.kit
110803-342	● nero/black	x1





ala



discover more about
Ala Collection

La panca Ala, disponibile nelle versioni a 2, 3, 4 e 5 posti, è la sintesi tra eleganza e robustezza. Disponibile in diverse varianti di colore, è personalizzabile anche con l'inserimento di un tavolino tra una seduta e l'altra, adatto per appoggiare riviste, depliant, le vostre borse e accessori. Perfetta sia per le grandi sale d'attesa, nella versione più lunga, che per gli spazi più ridotti, dove si adatta perfettamente. La seduta e lo schienale possono essere anche tappezzati.

The Ala bench, available in versions 2, 3, 4 and 5 positions, is the synthesis of elegance and strength. Available in several color combinations, it can also be customized with the insertion of a side table between seats which is suitable for supporting magazines, brochures, bags and accessories. Perfect for large waiting rooms, with the longer version, as well as for smaller spaces, where it fits perfectly. The seat and back can also be upholstered.

Plus

- Disponibile in 3 colorazioni.
- Configurazioni da 2 - 3 - 4 - 5 posti.
- Facile da assemblare.
- Available in 3 colors.
- 2 - 3 - 4 - 5 seat configurations.
- Easy to assemble.

ala

bench



la panca viene fornita in tutti i suoi componenti smontata

the bench supplied with all its components not assembled

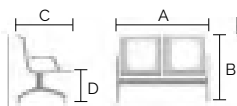

01 panca a due posti con due braccioli

bench two seats with two arms

code	finishing	q.kit	q.pack	a	b	c	d	kg.x1	vol.x1
110703-150	● nero/black	x1	5	1200	800	680	410	32.00	mc. 0.005
110704-150	● grigio/grey	x1	5	1200	800	680	410	32.00	mc. 0.005
110702-150	● bordeaux/bordeaux	x1	5	1200	800	680	410	32.00	mc. 0.005



la panca viene fornita in tutti i suoi componenti smontata

the bench supplied with all its components not assembled

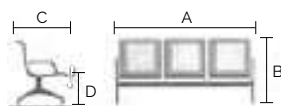

02 panca a tre posti con due braccioli

bench three seats with two arms

code	finishing	q.kit	q.pack	a	b	c	d	kg.x1	vol.x1
110703-152	● nero/black	x1	5	1800	800	680	410	45.00	mc. 0.115
110704-152	● grigio/grey	x1	5	1800	800	680	410	45.00	mc. 0.115
110702-152	● bordeaux/bordeaux	x1	5	1800	800	680	410	45.00	mc. 0.115



la panca viene fornita in tutti i suoi componenti smontata

the bench supplied with all its components not assembled

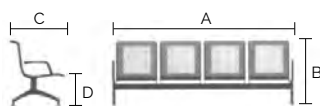

03 panca a quattro posti con due braccioli

bench four seats with two arms

code	finishing	q.kit	q.pack	a	b	c	d	kg.x1	vol.x1
110703-154	● nero/black	x1	5	2380	800	680	410	58.00	mc. 0.15
110704-154	● grigio/grey	x1	5	2380	800	680	410	58.00	mc. 0.15
110702-154	● bordeaux/bordeaux	x1	5	2380	800	680	410	58.00	mc. 0.15



la panca viene fornita in tutti i suoi componenti smontata

the bench supplied with all its components not assembled

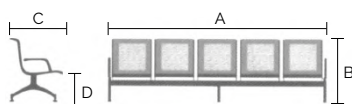

04 panca a cinque posti con due braccioli

bench five seats with two arms

code	finishing	q.kit	q.pack	a	b	c	d	kg.x1	vol.x1
110703-156	● nero/black	x1	5	2960	800	680	410	72.00	mc. 0.17
110704-156	● grigio/grey	x1	5	2960	800	680	410	72.00	mc. 0.17
110702-156	● bordeaux/bordeaux	x1	5	2960	800	680	410	72.00	mc. 0.17

ala

bench

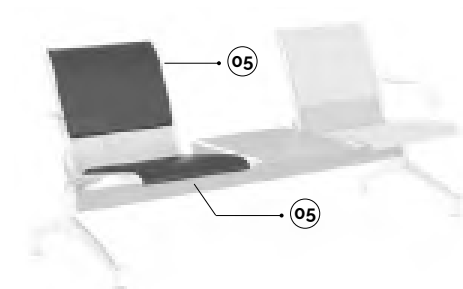

05 pannello sedile e schienale tappezzato similpelle completo di viti
panel seat and back upholstered in imitation leather with screws

code	finishing	q.kit	q.pack	kg.x1	vol.x1
143903-001	● nero/black	x1	5	2,30	mc. 0,008
143904-001	● grigio/grey	x1	5	2,30	mc. 0,008
143902-001	● bordeaux/bordeaux	x1	5	2,30	mc. 0,008

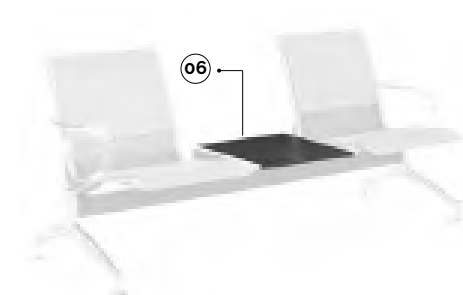

06 tavolo per panca in lamiera completo di viti
sheet metal table with screws

code	finishing	q.kit	q.pack	kg.x1	vol.x1
110703-151	● nero/black	x1	5	4,16	mc. 0,01
110704-151	● grigio/grey	x1	5	4,16	mc. 0,01
110702-151	● bordeaux/bordeaux	x1	5	4,16	mc. 0,01



siton



discover more about
Siton Collection

La panca con seduta ribaltabile.
Pensata per tutte quelle situazioni in cui non si vuole rinunciare all'eleganza, Siton presenta un meccanismo in alluminio per sedile ribaltabile, disegnato e realizzato per essere esso stesso un elemento di stile.

Siton è ideale per gli auditorium e le sale conferenza più prestigiose.

*Bench featuring a tip-up seat.
Designed for all those situations where a touch of elegance is required, Siton features an aluminium folding seat mechanism, designed and produced to be a style element in itself.*

Siton is ideal for the most prestigious auditoriums and conference rooms.

Plus

- Design distintivo.
- Meccanismo in alluminio ribaltabile.
- *Distinctive design.*
- *Aluminium folding mechanism.*



designed by:
Esdra

siton

bench

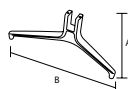
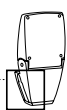
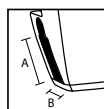
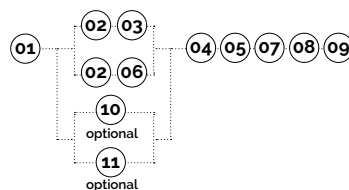

01

02

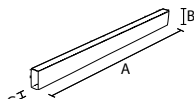

03

04



05

06

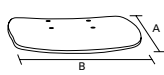

07

08



09

01 siton-mecanismo panca ribaltabile alluminio lucido
siton-polished aluminium folding mechanism

code	finishing	q.kit	q.pack	a	b	kg.x1	vol.x1
110704-180	● alluminio/aluminium	x1	4	80	40	2.81	mc. 0.007

02 siton-gamba lunga in alluminio per panca
siton-long aluminium leg for bench

code	finishing	q.kit	q.pack	a	b	kg.x1	vol.x1
110704-171	● alluminio/aluminium	x2	5	305	643	2.80	mc. 0.014

03 siton-bracciolo in alluminio per panca
siton-aluminium arm for bench

code	finishing	q.kit	q.pack	a	b	kg.x1	vol.x1
111704-030	● alluminio/aluminium	x1	10	280	303	1.30	mc. 0.0011

04 got(03) trave per panca 80x40
got(03) beam for bench 80x40

code	finishing	q.kit	q.pack	a	b	c	kg.x1	vol.x1	
110703-190	● nero/black	2 posti / 2 seats	x1	1	1160	80	40	3.20	mc. 0.0045
110704-190	● grigio/grey	2 posti / 2 seats	x1	1	1160	80	40	3.20	mc. 0.0045
110703-191	● nero/black	3 posti / 3 seats	x1	1	1710	80	40	4.71	mc. 0.005
110704-191	● grigio/grey	3 posti / 3 seats	x1	1	1710	80	40	4.71	mc. 0.005
110703-192	● nero/black	4 posti / 4 seats	x1	1	2260	80	40	6.22	mc. 0.0085
110704-192	● grigio/grey	4 posti / 4 seats	x1	1	2260	80	40	6.22	mc. 0.0085
110703-193	● nero/black	5 posti / 5 seats	x1	1	2800	80	40	7.72	mc. 0.01
110704-193	● grigio/grey	5 posti / 5 seats	x1	1	2800	80	40	7.72	mc. 0.01

05 siton-cavalletto in alluminio 80x40 per bracciolo panca
siton-aluminium bracket 80x40 for bench arm

code	finishing	q.kit	q.pack	kg.x1	vol.x1
111704-031	● alluminio/aluminium	x1	10	0.485	mc. 0.0012

06 siton-coperchio in alluminio per gamba panca
siton-aluminium cover for bench leg

code	finishing	q.kit	q.pack	kg.x1	vol.x1
110704-172	● alluminio/aluminium	x2	10	0.113	mc. 0.0002

07 siton-kit di dieci confezioni accessori per gamba panca
siton-ten packs accessories kit for leg bench

code	finishing	q.kit	q.pack	kg.x1	vol.x1
137000-005	● alluminio/aluminium	x1	1	0.85	mc. 0.004

08 siton-sedile per panca ribaltabile in legno verniciato + 4 testine e 4 viti fissaggio
siton-folding bench seat, varnished beechwood + 4 tunes and screws for fixing

code	finishing	q.kit	q.pack	a	b	kg.x1	vol.x1
122207-030	● faggio/beech	x1	10	420	400	1.40	mc. 0.01
122207-031	● wengè/wengè	x1	10	420	400	1.40	mc. 0.01

09 siton.schienale per panca ribaltabile in legno verniciato + 4 viti fissaggio
siton-folding bench back, varnished beechwood + 4 tunes and screws for fixing

code	finishing	q.kit	q.pack	a	b	kg.x1	vol.x1
122107-030	● faggio/beech	x1	10	690	460	3.30	mc. 0.02
122107-031	● wengè/wengè	x1	10	690	460	3.30	mc. 0.02

main component sizes

siton

bench leg options

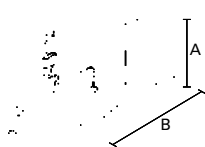

10 90gm(02)-gamba mobile per panca con accessori 90gm(02)-movable leg for bench with accessories

code	finishing	q.kit	q.pack	a	b	kg.x1	vol.x1
110703-120	● nero/black	x2	2	320	600	2,70	mc. 0,0012
110704-099	● grigio/grey	x2	2	320	600	2,70	mc. 0,0012
110710-007	● cromato/chrome	x2	2	320	600	2,70	mc. 0,0012

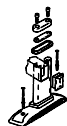
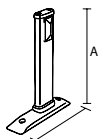

11 90gf(02)-gamba fissa per panca con accessori 90gf(02)-fixed leg for bench with accessories

code	finishing	q.kit	q.pack	a	b	kg.x1	vol.x1
110703-122	● nero/black	x2	2	320	310	1,80	mc. 0,0012
110704-107	● grigio/grey	x2	2	320	310	1,80	mc. 0,0012





duetto



discover more about
Duetto Collection

Duetto: l'innovativo sistema di scocche da incastro.
Massima versatilità di composizione di schienale e sedile, con la possibilità di mixarne i colori, assoluta funzionalità e design minimale, grazie all'assenza di accessori per il montaggio.
Opzionabile su tutti i telai il pannello in legno multistrato da tappezzare.
Disponibile anche la versione sgabello in due altezze: 730 mm e 630 mm.

Duetto si adatta agli ambienti Home e Contract.

Duetto: the innovative system of interlocking seat shell components. Maximum versatility in the composition of the backrest and seat, with the possibility of mixing colours. Outstanding functionality and minimalist design, requiring no accessories for assembly. The plywood panel to be upholstered is optional on all frame types. Stool version available in two heights: 730 mm and 630 mm.

Duetto adapts to Home and Contract environments.

Plus

- Possibilità di avere due pezzi in uno, mixandone i colori, grazie all'innovativo sistema da incastro tra scocche.
- Design minimale e sottile.
- Estrema versatilità di colori alla moda.
- Facile da sollevare grazie al foro centrale.
- Comodamente impilabile nella versione slitta e 4 gambe.
- Certificazione EN 16139:2013 Livello 1.
- *The innovative interlocking seat shell components mean two differently-coloured pieces can be combined together.*
- *Minimalist slimline design.*
- *Extreme versatility with range of trendy colours.*
- *Easy to lift thanks to the central hole.*
- *Easy stackability in both the slide and 4-legs versions.*
- *EN 16139:2013 Level 1 Certification.*



**trolley
available**



**certified
product**

duetto

slide



CERTIFIED BY
CATAS



plastic colours

- blu/blue ral 5014
- nero/black
- grigio/gray ral 7003
- bianco/white 218
- rosso/red 527

main component sizes

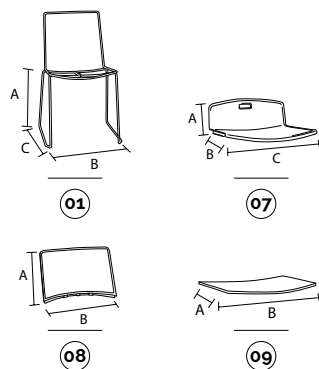

optionals

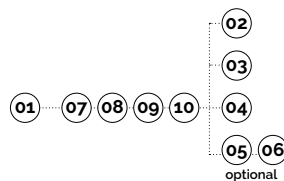
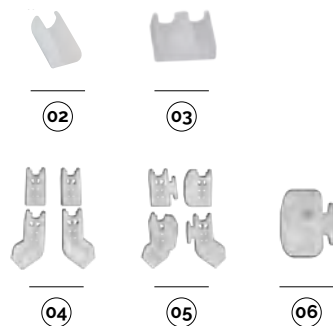

01 duetto-telaio a slitta in tondino d.11
duetto-slide wire frame d.11

code	finishing	q.kit	q.pack	a	b	c	kg.x1	vol.x1
113410-046	● cromato/chrome	x1	100	450	510	480	4,40	mc. 0.02

02 confezione di basi a pinza antirrotazione per tondino colore neutro
neutral clips base for wire d.11 package

code	finishing	q.kit	q.pack
137006-070	○ neutro/neutral	x4	200

03 base piana a pinza doppia
double flat clip base

code	finishing	q.kit
134006-021	○ neutro/neutral	x4

04 btf-kit piedini
btf-kit feet

code	finishing	q.kit	q.pack	kg.x1
134306-001	○ neutro/neutral	x1	100	0,05

05 btf-a-kit piedini con ganci
btf-a-kit feet with hooks

code	finishing	q.kit	q.pack	kg.x1
134306-002	○ neutro/neutral	x1	100	0,06

06 pptf-tappo per fissaggio pavimento
pptf-cap for fixing to the floor

code	finishing	q.kit	q.pack	kg.x1
134306-003	○ neutro/neutral	x2	100	0,03

07 duetto-sedile a vista in plastica colorato + pf1 neutri
duetto-plastic seat colored + pf1

code	finishing	q.kit	q.pack	a	b	c	kg.x1	vol.x1
132203-022	● nero/black	x1	10	180	390	430	0,80	mc. 0.09

08 duetto-schienale a vista in plastica colorato
duetto-plastic back colored

code	finishing	q.kit	q.pack	a	b	kg.x1	vol.x1
132103-022	● nero/black	x1	20	280	395	0,40	mc. 0.03

09 duetto-pannello sedile multistrato con 6 borchie m6
duetto-seat panel with 6 upholstery nail m6

code	finishing	q.kit	q.pack	a	b	kg.x1	vol.x1
122207-019	● faggio/plywood	x1	20	395	410	0,74	mc. 0.003

10 duetto-vite tbl combi m6x8 dentell. zincata bianca (vite per fissaggio pannello)
duetto-screw tbl combi m6x12 white zinc (screw for fix panel)

code	finishing	q.kit
117711-207	○ zincata bianca/white zinc	x6

for all colour codes, see page 288

duetto

stool



plastic colours

- blu/blue ral 5014
- nero/black
- grigio/gray ral 7003
- bianco/white 218
- rosso/red 527

main component sizes

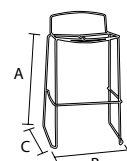

optionals

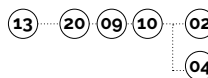
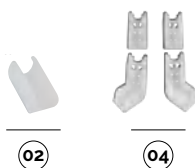

h.630	13 duetto-sgabello alto h.630 in tondino d.11 duetto-wire high bar stool h.630 d.11	code	finishing	q.kit	q.pack	a	b	c	kg.x1	vol.x1
	113410-048	● cromato/chrome		x1	50	630	525	500	5,70	mc. 0.04
h.730	13 duetto-sgabello alto h.730 in tondino d.11 duetto-wire high bar stool h.730 d.11	code	finishing	q.kit	q.pack	a	b	c	kg.x1	vol.x1
	113410-049	● cromato/chrome		x1	50	730	525	500	6,00	mc. 0.04
	02 confezione di basi a pinza antirrotazione per tondino colore neutro neutral clips base for wire d.11 package	code	finishing	q.kit	q.pack					
	137006-070	○ neutro/neutral		x4	200					
	04 btf-kit piedini btf-kit feet	code	finishing	q.kit	q.pack				kg.x1	
	134306-001	○ neutro/neutral		x1	100				0,05	
	20 duetto-sedile a vista in plastica colorato • pf1 neutri duetto-plastic seat colored • pf1	code	finishing	q.kit	q.pack	a	b	c	kg.x1	vol.x1
	132203-028	● nero/black		x1	10	180	390	430	0,80	mc. 0.09
	09 duetto-pannello sedile multistrato con 6 borchie m6 duetto-seat panel with 6 upholstery nail m6	code	finishing	q.kit	q.pack	a	b		kg.x1	vol.x1
	122207-019	● faggio/plywood		x1	20	395	410		0,74	mc. 0.003
	10 duetto-vite tbl combi m6x8 dentell. zincata bianca (vite per fissaggio pannello) duetto-screw tbl combi m6x12 white zinc (screw for fix panel)	code	finishing	q.kit						
	117711-207	○ zincata bianca/white zinc		x6						



for all colour codes, see page 288

duetto

4-legs



plastic colours

- blu/blue ral 5014
- nero/black
- grigio/gray ral 7003
- bianco/white 218
- rosso/red 527

main component sizes

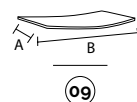
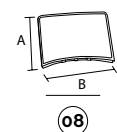
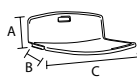
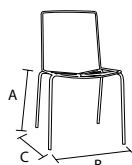

14 07 08 09 10 15

14 duetto-telaio 4 gambe in tubo d.16 senza tappi
duetto-4 legs frames d.16 without caps

code	finishing	q.kit	q.pack	a	b	c	kg.x1	vol.x1
112710-036	● cromato/chrome	x1	100	450	510	480	3,70	mc. 0.02
112703-036	● nero/black	x1	100	450	510	480	3,70	mc. 0.02
112704-036	● grigio/grey ikea 4	x1	100	450	510	480	3,70	mc. 0.02
112705-036	○ avorio/ivory ral1013	x1	100	450	510	480	3,70	mc. 0.02

15 puntale alettato tondo d.16 nero
inner cap for legs d.16 black

code	finishing	q.kit
134203-160	● nero/black	x4

07 duetto-sedile a vista in plastica colorato + pf1 neutri
duetto-plastic seat colored + pf1

code	finishing	q.kit	q.pack	a	b	c	kg.x1	vol.x1
132203-022	● nero/black	x1	10	180	390	430	0,80	mc. 0.09

08 duetto-schienale a vista in plastica colorato
duetto-plastic back colored

code	finishing	q.kit	q.pack	a	b	kg.x1	vol.x1
132103-022	● nero/black	x1	20	280	395	0,40	mc. 0.03

09 duetto-pannello sedile multistrato con 6 borchie m6
duetto-seat panel with 6 upholstery nail m6

code	finishing	q.kit	q.pack	a	b	kg.x1	vol.x1
122207-019	● faggio/plywood	x1	20	395	410	0,74	mc. 0.003

10 duetto-vite tbl combi m6x8 dentell. zincata bianca (vite per fissaggio pannello)
duetto-screw tbl combi m6x12 white zinc (screw for fix panel)

code	finishing	q.kit
117711-207	○ zincata bianca/white zinc	x6



for all colour codes, see page 288



duetto-carrello portasedie con accessori nero
duetto-trolley for chairs with accessories black

code	finishing	q.kit
110803-373	● nero/black	x1

duetto

bench



plastic colours

- blu/blue ral 5014
- nero/black
- grigio/gray ral 7003
- bianco/white 218
- rosso/red 527

19 07 08 09 10

main component sizes

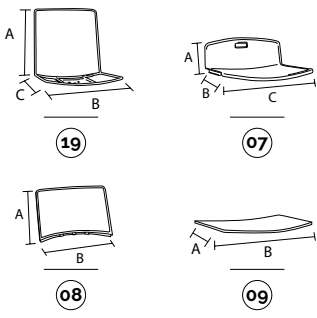

19 duetto-supporto per attacco scocca duetto su panca
duetto-bench frame for feel shell

code	finishing	q.kit	q.pack	a	b	c	kg.x1	vol.x1
110710-018	● cromato/chrome	x1	100	400	430	390	3,70	mc. 0.02

07 duetto-sedile a vista in plastica colorato + pf1 neutri
duetto-plastic seat colored + pf1 neutri

code	finishing	q.kit	q.pack	a	b	c	kg.x1	vol.x1
132203-022	● nero/black	x1	10	180	390	430	0,80	mc. 0.09

08 duetto-schienale a vista in plastica colorato
duetto-plastic back colored

code	finishing	q.kit	q.pack	a	b	kg.x1	vol.x1
132103-022	● nero/black	x1	20	280	395	0,40	mc. 0.03

09 duetto-pannello sedile multistrato con 6 borchie m6
duetto-seat panel with 6 upholstery nail m6

code	finishing	q.kit	q.pack	a	b	kg.x1	vol.x1
122207-019	● faggio/plywood	x1	20	395	410	0,74	mc. 0.003

10 duetto-vite tbl combi m6x8 dentell. zincata bianca (vite per fissaggio pannello)
duetto-screw tbl combi m6x12 white zinc (screw for fix panel)

code	finishing	q.kit
117711-207	○ zincata bianca/white zinc	x6

for the bench components, see page 417



for all colour codes, see page 288

optionals

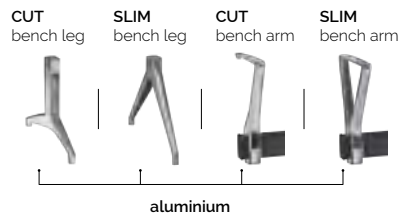

duetto

optional colour codes



plastic colour codes



07 sedile in plastica
plastic seat

- 132215-022 blu/blue ral 5014
- 132203-022 nero/black
- 132204-022 grigio/gray ral 7003
- 132205-022 bianco/white 218
- 132202-022 rosso/red 527



08 schienale in plastica
plastic backrest

- 132115-022 blu/blue ral 5014
- 132103-022 nero/black
- 132104-022 grigio/gray ral 7003
- 132105-022 bianco/white 218
- 132102-022 rosso/red 527



12 braccioli in plastica
plastic armrests

- 131715-075 blu/blue ral 5014
- 131703-075 nero/black
- 131704-075 grigio/gray ral 7003
- 131705-075 bianco/white 218
- 131702-075 rosso/red 527



20 sedile in plastica per sgabello
plastic seat for stool frame

- 132215-028 blu/blue ral 5014
- 132203-028 nero/black
- 132204-028 grigio/gray ral 7003
- 132205-028 bianco/white 218
- 132202-028 rosso/red 527

indicazioni colori plastiche
plastic colour indications

- multipli per scatola/multiples per box
- ● ● Moq. 250 pz.







manila



discover more about
Manila Collection

La monoscocca in plastica con braccioli integrati. Una seduta ampia, confortevole e resistente, dal design sottile e distintivo, con braccioli disegnati per abbracciarla. Estremamente versatile grazie al ricco assortimento di telai, opzionabili anche in diverse finiture.

Manila è nata per arredare qualsiasi ambiente Community e ben si adatta agli ambienti Office.

Plastic monocoque chair with integrated armrests. A generous, comfortable and durable seat, featuring a subtle-yet-distinctive design, with armrests designed to embrace. Extremely versatile thanks to the rich assortment of frames. Available in a range of finishes.

Manila was created to furnish any Community environment and adapts perfectly also to Office environments.

Plus

- Dimensioni generose e massimo comfort della scocca.
- Design distintivo grazie ai braccioli integrati e alla scocca unica.
- 6 colori di tendenza disponibili per la scocca.
- Massima versatilità.
- Opzionabile il pannello in legno da tappezzare.
- *Generously-dimensioned seat shell providing maximum comfort.*
- *Distinctive design thanks to the integrated armrests and the unique seat shell.*
- *6 trendy colours available for the seat shell.*
- *Maximum versatility.*
- *Optional wooden seat pad to be upholstered.*

manila

slide



plastic colours

- rosso/red p1797u
- grigio/grey warm grey 6c
- avorio/ivory ral1013
- marrone/brown ral69g
- giallo/yellow ral110u
- blu/blue ral5014

main component sizes

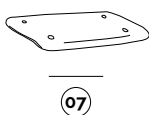
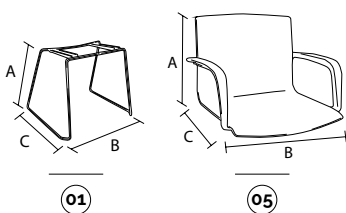

optionals

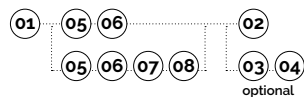
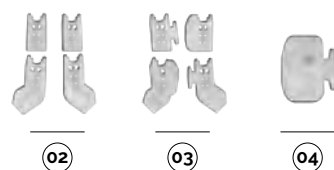

01 manila-telaio a slitta in tondino d.12 manila-slide wire framed.12

code	finishing	q.kit	q.pack	a	b	c	kg.x1	vol.x1
113403-333	● nero/black	x1	100	445	580	495	4,00	mc. 0,026
113405-333	○ avorio/ivory ral1013	x1	100	445	580	495	4,00	mc. 0,026
113410-333	● cromato/chrome	x1	100	445	580	495	4,00	mc. 0,026

02 btf-kit piedini btf-kit feet

code	finishing	q.kit	q.pack	kg.x1
134306-001	○ neutro/neutral	x1	100	0,05

03 btf-a-kit piedini con ganci btf-a-kit feet with hooks

code	finishing	q.kit	q.pack	kg.x1
134306-002	○ neutro/neutral	x1	100	0,06

04 pptf-tappo per fissaggio pavimento pptf-cap for fixing to the floor

code	finishing	q.kit	q.pack	kg.x1
134306-003	○ neutro/neutral	x2	100	0,03

05 manila-scocca intera con braccioli manila-plastic shell with arms

code	finishing	q.kit	q.pack	a	b	c	kg.x1	vol.x1
133904-045	● grigio/grey warm grey 6c	x1	5	390	580	480	2,60	mc. 0,05

06 manila-vite tc-combi 6x16 testa cilindrica a croce zincata (vite per fissaggio scocca) manila-screw combi 6x16 cylindrical head cross zinc (screw for fix shell)

code	finishing	q.kit
117811-181	● zincata/zinc	x4

07 manila-pannello sedile multistrato con 6 borchie m6 manila-seat panel with 6 upholstery nail m6

code	finishing	q.kit	q.pack	kg.x1	vol.x1
122207-034	● faggio/plywood	x1	20	0,78	mc. 0,003

08 manila-vite tbl combi m6x12 zincata bianca (vite per fissaggio pannello) manila-screw tbl combi m6x12 white zinc (screw for fix panel)

code	finishing	q.kit
117711-206	○ zincata bianca/white zinc	x6



manila

slide



plastic colours

- rosso/red p1797u
- grigio/grey warm grey 6c
- avorio/ivory ral1013
- marrone/brown ral699
- giallo/yellow ral110u
- blu/blue ral5014

main component sizes

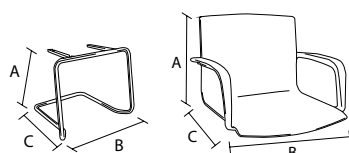

09

05

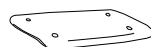

07

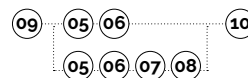

09 manila-base a slitta in tubo asform d.22 tappi esclusi
manila-slide frame asform pipe d.22 without caps

code	finishing	q.kit	q.pack	a	b	c	kg.x1	vol.x1
110503-417	● nero/black	x1	64	450	545	545	4.10	mc. 0.0313
110504-417	● grigio/grey ig2621	x1	64	450	545	545	4.10	mc. 0.0313
110505-417	○ avorio/ivory ral1013	x1	64	450	545	545	4.10	mc. 0.0313
110510-417	● cromato/chrome	x1	64	450	545	545	4.10	mc. 0.0313

10 p2p-pinza due pioli in polietilene nera
p2p-two pins pliers in black polythene

code	finishing	q.kit
134003-003	● nero/black	x6

05 manila-scocca intera con braccioli
manila-plastic shell with arms

code	finishing	q.kit	q.pack	a	b	c	kg.x1	vol.x1
133904-045	● grigio/grey warm grey 6c	x1	5	390	580	480	2.60	mc. 0.05

06 manila-vite tc+combi 6x16 testa cilindrica a croce zincata (vite per fissaggio scocca)
manila-screw combi 6x16 cylindrical head cross zinc (screw for fix shell)

code	finishing	q.kit
117811-181	● zincata/zinc	x4

07 manila-pannello sedile multistrato con 6 borchie m6
manila-seat panel with 6 upholstery nail m6

code	finishing	q.kit	q.pack	kg.x1	vol.x1
122207-034	● faggio/plywood	x1	20	0.78	mc. 0.003

08 manila-vite tbl combi m6x12 zincata bianca (vite per fissaggio pannello)
manila-screw tbl combi m6x12 white zinc (screw for fix panel)

code	finishing	q.kit
117711-206	○ zincata bianca/white zinc	x6



for all colour codes, see page 297

manila

4-legs



plastic colours

- rosso/red p1797u
- grigio/grey warm grey 6c
- avorio/ivory ral1013
- marrone/brown ral69g
- giallo/yellow ral110u
- blu/blue ral5014

main component sizes

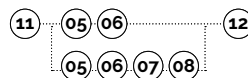
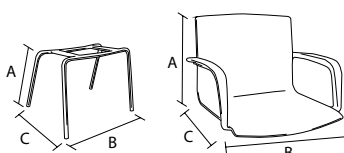

11 manila-telaio 4 gambe d.22 senza tappi

manila-4 legs frames d.22 without caps

code	finishing	q.kit	q.pack	a	b	c	kg.x1	vol.x1
110103-259	● nero/black	x1	80	440	585	490	2,70	mc. 0.035
110104-259	● grigio/grey ig2621	x1	80	440	585	490	2,70	mc. 0.035
110105-259	○ avorio/ivory ral1013	x1	80	440	585	490	2,70	mc. 0.035
110110-259	● cromato/chrome	x1	80	440	585	490	2,70	mc. 0.035

12 tappo 22 testa sferica nero

cap 22 spherical head black

code	finishing	q.kit
134203-224	● nero/black	x4

05 manila-scocca intera con braccioli

manila-plastic shell with arms

code	finishing	q.kit	q.pack	a	b	c	kg.x1	vol.x1
133904-045	● grigio/grey warm grey 6c	x1	5	390	580	480	2,60	mc. 0.05

06 manila-vite tc-combi 6x16 testa cilindrica a croce zincata (vite per fissaggio scocca)

manila-screw combi 6x16 cylindrical head cross zinc (screw for fix shell)

code	finishing	q.kit
117811-181	● zincata/zinc	x4

07 manila-pannello sedile multistrato con 6 borchie m6

manila-seat panel with 6 upholstery nail m6

code	finishing	q.kit	q.pack	kg.x1	vol.x1
122207-034	● faggio/plywood	x1	20	0,78	mc. 0.003

08 manila-vite tbi combi m6x12 zincata bianca (vite per fissaggio pannello)

manila-screw tbi combi m6x12 white zinc (screw for fix panel)

code	finishing	q.kit
117711-206	○ zincata bianca/white zinc	x6



for all colour codes, see page 297

manila

swivel



plastic colours

- rosso/red p1797u
- grigio/grey warm grey 6c
- avorio/ivory ral1013
- marrone/brown ral699
- giallo/yellow ral110u
- blu/blue ral5014

main component sizes

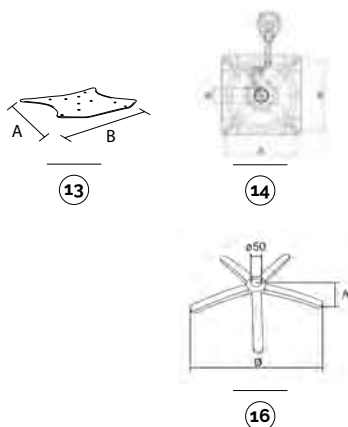

optionals

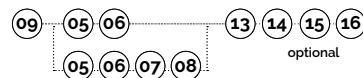
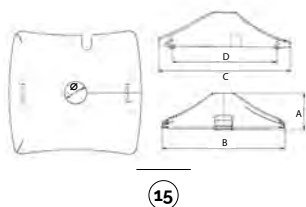

13 manila-telaio per girevole/panca manila-swivel/bench frame

code	finishing	q.kit	q.pack	a	b	kg.x1	vol.x1
110903-256	● nero/black	x1	10	265	325	2,00	mc. 0.0019
110904-256	● grigio/grey ig2621	x1	10	265	325	2,00	mc. 0.0019

14 pss28nr-piastra sgabello c/spat. c/28 3' l4 nera pss28nr- square metal plate with straight lever c/28 3' l4

code	finishing	q.kit	q.pack	a	b	ø	kg.x1	vol.x1
113003-104	● nero/black	x1	25	150	150	28	1,23	mc. 0.002

15 cpg-copertina in plastica per telaio girevole cpg-plastic cover for swivel frame

code	finishing	q.kit	q.pack	a	b	c	d	ø	kg.x1	vol.x1
130903-000	● nero/black	x1	50	60	200	210	167	36	0,1	mc. 0.0015

16 b40-base in metallo d.640 con coprisaldatura b40-metal base d.640 with cover welding

code	finishing	q.kit	q.pack	a	ø	kg.x1	vol.x1
110210-027	● cromato/chrome	x1	5	60	640	2,85	mc. 0.014

for the components below, see previous pages

05 06 07 08

CPG
plastic cover for swivel frame

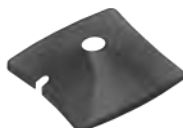

for all colour codes, see page 297

manila

bench



plastic colours

- rosso/red p1797u
- grigio/grey warm grey 6c
- avorio/ivory ral1013
- marrone/brown ral69g
- giallo/yellow ral110u
- blu/blue ral5014

main component sizes

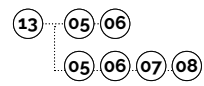
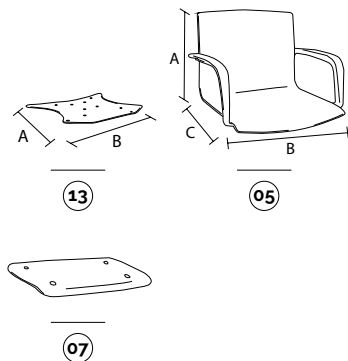

13 manila-telaio per girevole/panca manila-swivel/bench frame		q.kit	q.pack	a	b	kg.x1	vol.x1	
code	finishing							
110903-256	● nero/black	x1	10	265	325	2,00	mc. 0,0019	
110904-256	● grigio/grey ig2621	x1	10	265	325	2,00	mc. 0,0019	
05 manila-scocca intera con braccioli manila-plastic shell with arms		q.kit	q.pack	a	b	c	kg.x1	vol.x1
code	finishing							
133904-045	● grigio/grey warm grey 6c	x1	5	390	580	480	2,60	mc. 0,05
06 manila-vite tc*combi 6x16 testa cilindrica a croce zincata (vite per fissaggio scocca) manila-screw combi 6x16 cylindrical head cross zinc (screw for fix shell)		q.kit						
code	finishing							
117811-181	● zincata/zinc	x4						
07 manila-pannello sedile multistrato con 6 borchie m6 manila-seat panel with 6 upholstery nail m6		q.kit	q.pack					
code	finishing							
122207-034	● faggio/plywood	x1	20					
08 manila-vite tbi combi m6x12 zincata bianca (vite per fissaggio pannello) manila-screw tbi combi m6x12 white zinc (screw for fix panel)		q.kit						
code	finishing							
117711-206	○ zincata bianca/white zinc	x6						

for the components below, see previous pages

for all colour codes, see page 297

optionals

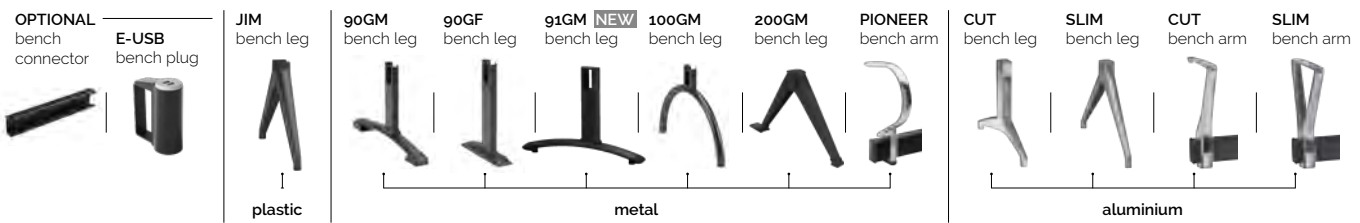

manila

optional colour codes



shell colour codes



05 scocche in plastica
plastic shells

- 133902-045 rosso/red p1797u
- 133904-045 grigio/grey warm grey 6c
- 133905-045 avorio/ivory ral1013
- 133907-045 marrone/brown ral699
- 133908-045 giallo/yellow ral110u
- 133915-045 blu/blue ral5014





pluto



discover more about
Pluto Collection

La monoscocca dal design moderno ed essenziale.
Estremamente versatile e funzionale vanta uno stile minimale, caratterizzato dal particolare foro centrale della monoscocca. Diversi i telai abbinabili; opzionabili il pannellino in plastica da tappezzare e i pratici agganci laterali.

Pluto è una buona soluzione per l'ambiente Contract e l'ambiente Home.

Monocoque chair with a modern and essential design. Extremely versatile and functional, it boasts minimalist styling, characterized by the distinctive central hole of the monocoque. Full range of matching frames; with optional plastic seat pad to be upholstered and practical lateral hooks.

Pluto is your ideal solution for Contract environment and the Home environments.

Plus

- Design minimal in 6 diversi colori di tendenza.
- Massima versatilità con la monoscocca abbinabile a diversi tipi di telai.
- Plastiche per outdoor.
- Impilabilità ed estrema facilità di pulizia.
- Certificazione ANSI/BIFMA X5.1 (per la versione 4 gambe, la certificazione è disponibile solo con uno speciale telaio da 2 mm di spessore).
- Minimalist design in 6 different trendy colours.
- Highly versatile monocoque design that can be combined with different types of frames.
- Plastics for outdoor use.
- Stackable and extremely easy to clean.
- ANSI/BIFMA X5.1 Certification (for the 4-leg version, certification is only available with a special 2mm thick frame).



**plastic
protection**



**certified
product**

pluto

slide

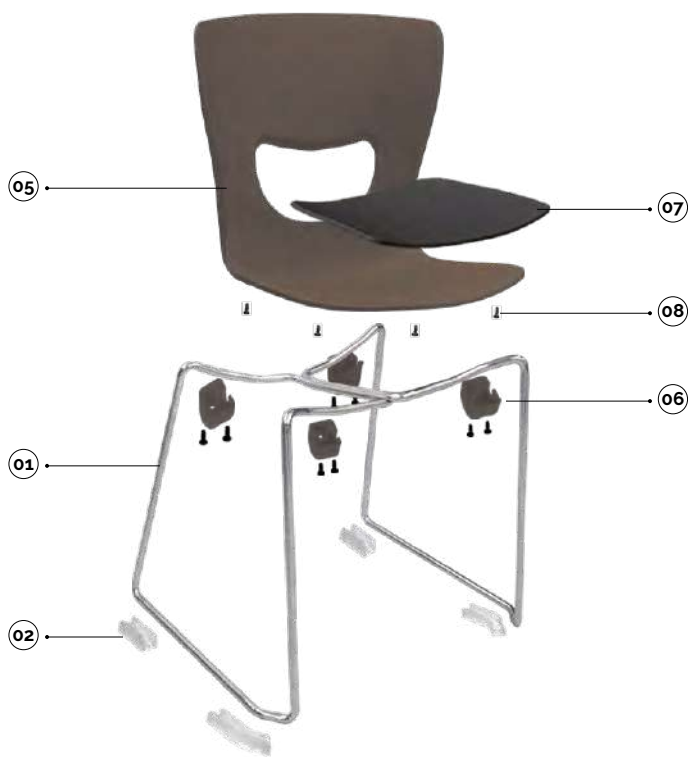

plastic colours

- rosso/red p1797u
- marrone/brown ral 8022
- grigio/grey ral7003
- avorio/ivory ral1013
- giallo/yellow ral1012
- blu/blue ral5014

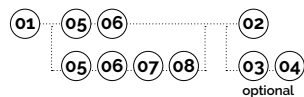

main component sizes

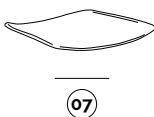
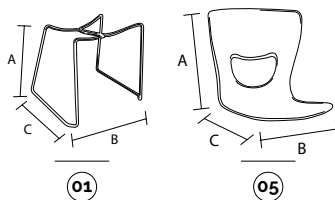

optionals

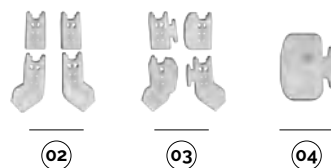

01 pluto-telaio a slitta in tondino d.12 pluto-slide wire frame d.12

code	finishing	q.kit	q.pack	a	b	c	kg.x1	vol.x1
113410-044	● cromato/chrome	x1	100	430	470	450	3,40	mc. 0.03

02 btf-kit piedini btf-kit feet

code	finishing	q.kit	q.pack	kg.x1
134306-001	○ neutro/neutral	x1	100	0,05

03 btf-a-kit piedini con ganci btf-a-kit feet with hooks

code	finishing	q.kit	q.pack	kg.x1
134306-002	○ neutro/neutral	x1	100	0,06

04 pptf-tappo per fissaggio pavimento pptf-cap for fixing to the floor

code	finishing	q.kit	q.pack	kg.x1
134306-003	○ neutro/neutral	x2	100	0,03

05 pluto-scocca intera modello pluto pluto-plastic shell model pluto

code	finishing	q.kit	q.pack	a	b	c	kg.x1	vol.x1
133907-065	● marrone/brown ral8022	x1	10	420	435	435	1,946	mc. 0.02

06 pluto-confezione accessori per scocca pluto per filo pluto-accessory pack for shell pluto for wire

code	finishing	q.kit	q.pack	kg.x1	vol.x1
137003-004	● marrone/brown ral8022	x1	10	telaio in tondino/wire frame	0,085 mc. 0.001

07 pluto-pannello sedile da tappezzare pluto-panel back for upholstery

code	finishing	q.kit	q.pack	vol.x1
132203-047	● nero/black	x1	20	mc. 0.003

08 confezione viti tbl+fr 5x14 (per pannello da tappezzare) screws tbl+ fr:nilo d.5x14 zinc.black (to fix seat panel) package

code	finishing	q.kit	q.pack
117003-071	● nero/black	x4	200



for all colour codes, see page 305

pluto

4-legs



CERTIFIED BY
BIFMA



plastic colours

- rosso/red p1797u
- marrone/brown ral 8022
- grigio/grey ral7003
- avorio/ivory ral1013
- giallo/yellow ral1012
- blu/blue ral5014

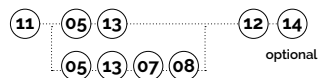

main component sizes

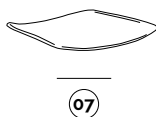
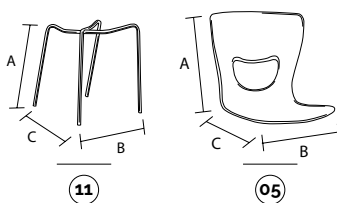

optionals

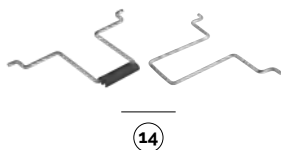

11 pluto-telaio 4 gambe in tubo d.18 senza tappi pluto-4 legs frame d.18 without caps

code	finishing	q.kit	q.pack	a	b	c	kg.x1	vol.x1
110603-022	● nero/black	x1	200	450	450	520	1,70	mc. 0,02
110604-022	● grigio/grey ig2621	x1	200	450	450	520	1,70	mc. 0,02
110605-023	○ avorio/ivory ral1013	x1	200	450	450	520	1,70	mc. 0,02
110610-135	● cromato/chrome	x1	200	450	450	520	1,70	mc. 0,02

12 confezione puntali tondi d.18 neri black inner round caps d.18 package

code	finishing	q.kit	q.pack
137003-072	● nero/black	x4	200
134205-181	○ bianco/white	x4	

05 pluto-scocca intera modello pluto pluto-plastic shell model pluto

code	finishing	q.kit	q.pack	a	b	c	kg.x1	vol.x1
133907-065	● marrone/brown ral8022	x1	10	420	435	435	1,946	mc. 0,02

13 pluto-confezione accessori per scocca pluto per tubo plutoaccessory pack for shell pluto per tube

code	finishing	q.kit	q.pack	kg.x1	vol.x1
137003-003	● marrone/brown ral8022	x1	10	telaio tubo/tube frame	0,085 mc. 0,001

07 pluto-pannello sedile da tappezzare pluto-panel back for upholstery

code	finishing	q.kit	q.pack	vol.x1
132203-047	● nero/black	x1	20	mc. 0,003

08 confezione viti tbl+ fr.hilo d5x14 zinc.black (to fix seat panel) package

code	finishing	q.kit	q.pack
117003-071	● nero/black	x4	200

14 pluto-coppia agganci laterale in tondino + plastica pluto-pair side wire hooks + plastic

code	finishing	q.kit	q.pack
113410-004	● cromato/chrome	x1	50



for all colour codes, see page 305

pluto

stool

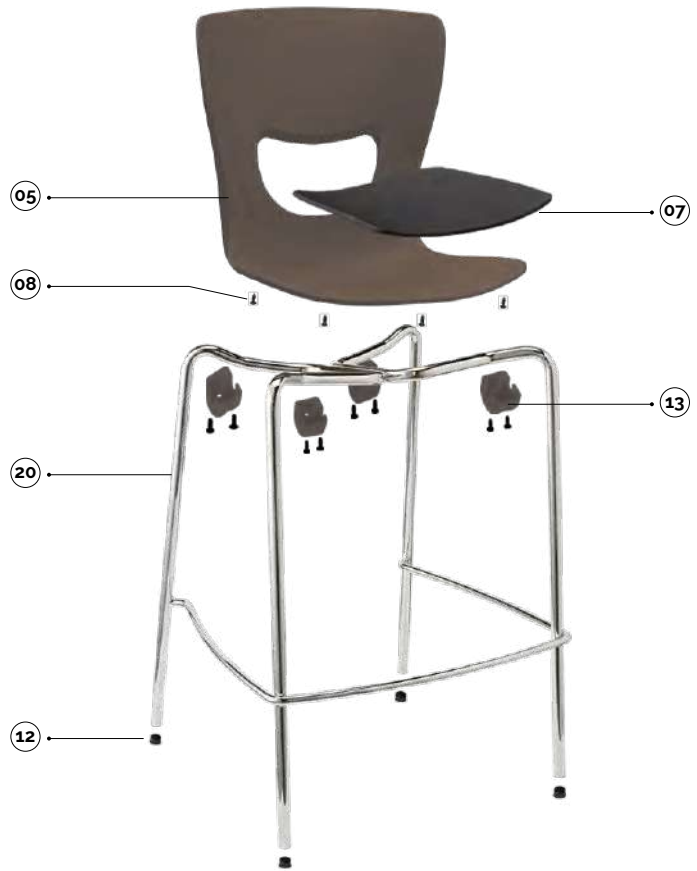

plastic colours

- rosso/red p1797u
- marrone/brown ral 8022
- grigio/grey ral7003
- avorio/ivory ral1013
- giallo/yellow ral1012
- blu/blue ral5014

main component sizes

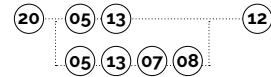
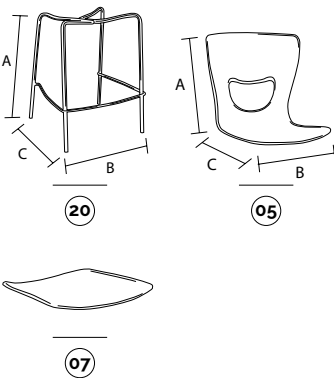

20 pluto-sgabello alto h630 in tubo per scocca senza tappi

pluto-high bar stool h630 in tube for shell pluto without caps

code	finishing	q.kit	q.pack	a	b	c	kg.x1	vol.x1
110603-039	● nero/black	x1	50	630	470	500	4,20	mc. 0,08
110604-039	● grigio/grey ig2621	x1	50	630	470	500	4,20	mc. 0,08
110605-039	○ avorio/ivory ral1013	x1	50	630	470	500	4,20	mc. 0,08
110610-039	● cromato/chrome	x1	50	630	470	500	4,20	mc. 0,08

12 confezione puntali tondi d.18 neri

black inner round caps d.18 package

code	finishing	q.kit	q.pack
137003-072	● nero/black	x4	200
134205-181	○ bianco/white	x4	

05 pluto-scocca intera modello pluto

pluto-plastic shell model pluto

code	finishing	q.kit	q.pack	a	b	c	kg.x1	vol.x1
133907-065	● marrone/brown ral8022	x1	10	420	435	435	1,946	mc. 0,02

13 pluto-confezione accessori per scocca pluto per tubo

plutoaccessory pack for shell pluto for tube

code	finishing	q.kit	q.pack	kg.x1	vol.x1
137003-003	● marrone/brown ral8022	x1	10	telaio tubo/tube frame	0,085 mc. 0,001

07 pluto-pannello sedile da tappezzare

pluto-panel back for upholstery

code	finishing	q.kit	q.pack	vol.x1
132203-047	● nero/black	x1	20	mc. 0,003

08 confezione viti tbl+ fr 5x14 (per pannello da tappezzare)

screws tbl+ fr.hilo d.5x14 zinc.black (to fix seat panel) package

code	finishing	q.kit	q.pack
117003-071	● nero/black	x4	200



for all colour codes, see page 305

pluto

swivel



plastic colours

- rosso/red p1797u
- marrone/brown ral 8022
- grigio/grey ral7003
- avorio/ivory ral1013
- giallo/yellow ral1012
- blu/blue ral5014

main component sizes

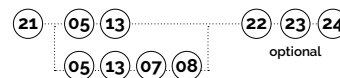
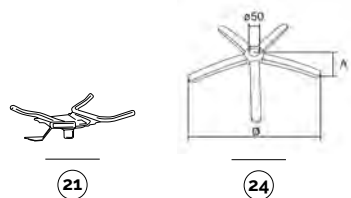

21 pluto-supporto girevole a gas per scocca pluto

pluto-swivel frame for pluto shell

code	finishing	q.kit	q.pack	kg.x1	vol.x1
110903-012	● nero/black	x1	10	1.40	mc. 0.004
110904-012	● grigio/grey ig2621	x1	10	1.40	mc. 0.004

22 confezione tappi copritesta d18 neri

black cover head caps d.18 package

code	finishing	q.kit	q.pack
137003-070	● nero/black	x4	200

23 cpq-copertina in plastica per telaio girevole

cpq-plastic cover for swivel frame

code	finishing	q.kit	q.pack	a	b	c	d	ø	kg.x1	vol.x1
130903-000	● nero/black	x1	50	60	200	210	167	36	0.1	mc. 0.0015

24 b40-base in metallo d.640 con coprisaldatura

b40-metal base d.640 with cover welding

code	finishing	q.kit	q.pack	a	ø	kg.x1	vol.x1
110210-027	● cromato/chrome	x1	5	60	640	2.85	mc. 0.014

for the components below, see previous pages

05 13 07 08



for all colour codes, see page 305

optionals

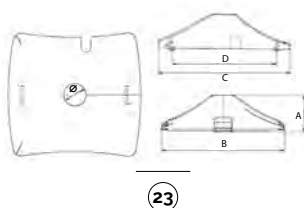

CPG
plastic cover for swivel frame



pluto

bench



plastic colours

- rosso/red p1797u
- marrone/brown ral 8022
- grigio/grey ral7003
- avorio/ivory ral1013
- giallo/yellow ral1012
- blu/blue ral5014

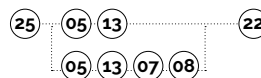

25 pluto-supporto per attacco scocca pluto su panca
pluto-bench frame for pluto shell

code	finishing	q.kit	q.pack	kg.x1	vol.x1
110703-188	● nero/black	x1	10	1.40	mc. 0.004

22 confezione tappi copritesta d18 neri
black cover head caps d.18 package

code	finishing	q.kit	q.pack
137003-070	● nero/black	x4	200



25

main component sizes

for the components below, see previous pages

05 13 07 08



for all colour codes, see page 305

for the bench components, see page 417

optionals

OPTIONAL
bench
connector



E-USB
bench plug



JIM
bench leg



plastic

90GM
bench leg



90GF
bench leg



91GM **NEW**
bench leg



100GM
bench leg



200GM
bench leg



PIONEER
bench arm



CUT
bench leg



SLIM
bench leg



CUT
bench arm



SLIM
bench arm



aluminium



shell colour codes



05 scocche in plastica plastic shells

- 133902-065 rosso/red p1797u
- 133907-065 marrone/brown ral 8022
- 133904-065 grigio/grey ral7003
- 133905-065 avorio/ivory ral1013
- 133908-065 giallo/yellow ral1012
- 133915-065 blu/blue ral5014



13 accessori in plastica per telaio 4-gambe/sgabello/girevole/panca plastic accessories for 4-legs/stool/swivel/bench frame

- 137002-003 rosso/red p1797u
- 137003-003 marrone/brown ral 8022
- 137004-003 grigio/grey ral7003
- 137005-003 avorio/ivory ral1013
- 137008-003 giallo/yellow ral1012
- 137015-003 blu/blue ral5014

accessory colour codes



06 accessori in plastica per telaio a filo plastic accessories for wire frame

- 137002-004 rosso/red p1797u
- 137003-004 marrone/brown ral 8022
- 137004-004 grigio/grey ral7003
- 137005-004 avorio/ivory ral1013
- 137008-004 giallo/yellow ral1012
- 137015-004 blu/blue ral5014





teddy



discover more about
Teddy Collection

La seduta per la scuola che rispetta la normativa.
Estremamente robusta e confortevole.
Teddy è una soluzione pratica e versatile, perfetta per la scuola.
Disponibile anche con telaio a slitta rovesciata per favorire la pulizia dell'ambiente circostante.

Teddy è nata per l'ambiente scuola.

*The school chair that complies with regulations.
Extremely robust and comfortable.
Teddy is a practical and versatile solution, perfect for schools.
Also available with inverted sled frame to facilitate cleaning of the surrounding environment.*

Teddy was created for school environments.

Plus

- 4 dimensionalità per i telai e 2 per le scocche.
- 4 i colori disponibili della scocca, dedicati all'ambiente school.
- 3 le diverse possibili finiture dei telai.
- Massima la robustezza e assoluto il confort.
- Facile da sollevare grazie al foro centrale nella scocca.
- Pratica da impilare.
- 4 sizes of frame and 2 sizes of seat shell.
- Seat shell available in 4 colours, specifically selected for school environments.
- 3 different possible frame finishes.
- Maximum strength and absolute confort.
- Easy to lift thanks to the central hole in the seat shell.
- Practical and stackable.

teddy

slide

H. 460



plastic colours

- rosso/red ral3002
- giallo/yellow ral1021
- blu/blue ral517
- verde/green ral6001

01 02 03 04 05 06 07 08 09

main component sizes

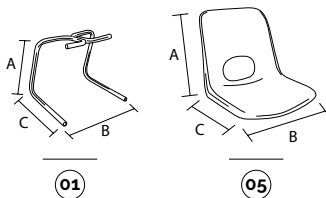

01 teddy-telaio slitta d.25 asform senza tappi 6" livello

teddy-slide frames d.25 asform without caps 6" level

code	finishing	q.kit	q.pack	a	b	c	kg.x1	vol.x1
110503-117	● nero/black	x1	64	435	455	465	4.0	mc. 0.02
110504-117	● grigio/grey ral2220	x1	64	435	455	465	4.0	mc. 0.02
110510-117	● cromato/chrome	x1	64	435	455	465	4.0	mc. 0.02

02 teddy-piedino antiribaltamento in plastica nera

teddy-black plastic anti-upsetting feet

code	finishing	q.kit
134303-016	● nero/black	x2

03 teddy-piedino posteriore in plastica nera

teddy-black plastic rear feet

code	finishing	q.kit
134303-017	● nero/black	x2

04 vite autofilettante ph tc+ 4,8x19 zincata nera

screw auto-threading ph tc+ 4,8x19 black zinc

code	finishing	q.kit
117803-165	● zincata nera/black zinc	x6

05 teddy-scocca intera modello teddy livello 5" - 6"

teddy-plastic shell model teddy level 5" - 6"

code	finishing	q.kit	q.pack	a	b	c	kg.x1	vol.x1
133915-067	● blu/blue ral517	x1	10	375	380	350	0,946	mc. 0,018

06 confezione viti hilo d.5x35 testa svasata a croce zincate

screws auto-thread 5x35 flared cross head zinc for shell fixing package

code	finishing	q.kit	q.pack
117011-070	● zincata/zinc	x4	200

07 pit-paracolpi con incavo

pit-buffer with cavity

code	finishing	q.kit
134006-103	○ neutro/neutral	x4

08 vite autoforante tc+ 4,8x16 zincata

self drilling screw +tc 4,8x16 zinc

code	finishing	q.kit
117811-152	● zincata/zinc	x4

09 tappo copritesta alettato tc22 ø22

black round cover head caps tc22 d.22

code	finishing	q.kit
134103-220	● nero/black	x2
134104-220	● grigio/grey	x2



for all colour codes, see page 313

teddy

4-legs

H. 350 3° LIVELLO
3° LEVEL



plastic colours

- rosso/red ral3002
- giallo/yellow ral1021
- blu/blue ral517
- verde/green ral6001

10 11 12 06

main component sizes

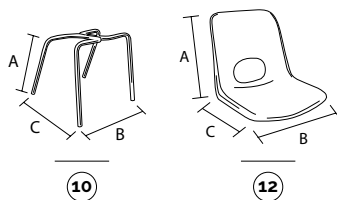

10 teddy-telaio 4 gambe d.22 senza tappi 3° livello
teddy-4 legs frames d.22 without caps 3° level

code	finishing	q.kit	q.pack	a	b	c	kg.x1	vol.x1
110103-050	● nero/black	x1	80	325	380	390	1.80	mc. 0.02
110104-050	● grigio/grey ral2220	x1	80	325	380	390	1.80	mc. 0.02
110110-050	● cromato/chrome	x1	80	325	380	390	1.80	mc. 0.02

11 tappo ø22 testa sferica
cap ø22 spherical head

code	finishing	q.kit
134203-224	● nero/black	x4

12 teddy-scocca intera modello teddy livello 3°- 4°
teddy-plastic shell model teddy level 3°- 4°

code	finishing	q.kit	q.pack	a	b	c	kg.x1	vol.x1
133916-066	● verde/green ral6001	x1	10	335	325	290	0.624	mc. 0.016

06 confezione viti hilo d.5x35 testa svasata a croce zincate
screws auto-thread 5x35 flared cross head zinc for shell fixing package

code	finishing	q.kit	q.pack
117011-070	● zincata/zinc	x4	200



for all colour codes, see page 313

teddy

4-legs

H. 380 4° LIVELLO
4° LEVEL



plastic colours

- rosso/red ral3002
- giallo/yellow ral1021
- blu/blue ral517
- verde/green ral6001

13 11 12 06

main component sizes

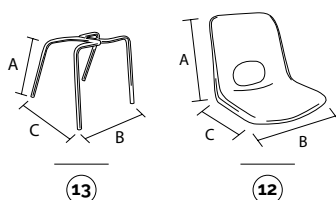

13 teddy-telaio 4 gambe d.22 senza tappi 4° livello
teddy-4 legs frames d.22 without caps 4° level

code	finishing	q.kit	q.pack	a	b	c	kg.x1	vol.x1
110103-051	● nero/black	x1	80	350	380	410	2,0	mc. 0,02
110104-051	● grigio/grey ral2220	x1	80	350	380	410	2,0	mc. 0,02
110110-051	● cromato/chrome	x1	80	350	380	410	2,0	mc. 0,02

11 tappo ø22 testa sferica
cap ø22 spherical head

code	finishing	q.kit
134203-224	● nero/black	x4

12 teddy-scocca intera modello teddy livello 3°- 4°
teddy-plastic shell model teddy level 3°- 4°

code	finishing	q.kit	q.pack	a	b	c	kg.x1	vol.x1
133902-066	● rosso/red ral3002	x1	10	335	325	290	0,624	mc. 0,016

06 confezione viti hilo d.5x35 testa svasata a croce zincate
screws auto-thread 5x35 flared cross head zinc for shell fixing package

code	finishing	q.kit	q.pack
117011-070	● zincata/zinc	x4	200



for all colour codes, see page 313

teddy

4-legs

H. 430 5° LIVELLO
5° LEVEL



14 11 05 06

plastic colours

- rosso/red ral3002
- giallo/yellow ral1021
- blu/blue ral517
- verde/green ral6001

main component sizes

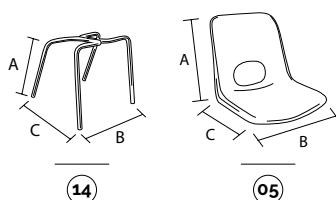

14 teddy-telaio 4 gambe d.22 senza tappi 5° livello
teddy-4 legs frames d.22 without caps 5° level

code	finishing	q.kit	q.pack	a	b	c	kg.x1	vol.x1
110103-052	● nero/black	x1	80	405	435	485	2.20	mc. 0.02
110104-052	● grigio/grey ral2220	x1	80	405	435	485	2.20	mc. 0.02
110110-052	● cromato/chrome	x1	80	405	435	485	2.20	mc. 0.02

11 tappo ø22 testa sferica
cap ø22 spherical head

code	finishing	q.kit
134203-224	● nero/black	x4

05 teddy-scocca intera modello teddy livello 5°- 6°
teddy-plastic shell model teddy level 5°- 6°

code	finishing	q.kit	q.pack	a	b	c	kg.x1	vol.x1
133908-067	● giallo/yellow ral1021	x1	10	375	380	350	0.946	mc. 0.018

06 confezione viti hilo d.5x35 testa svasata a croce zincate
screws auto-thread 5x35 flared cross head zinc for shell fixing package

code	finishing	q.kit	q.pack
117011-070	● zincata/zinc	x4	200



for all colour codes, see page 313

teddy

4-legs

H. 460

6° LIVELLO
6° LEVEL



15 11 05 06

plastic colours

- rosso/red ral3002
- giallo/yellow ral1021
- blu/blue ral517
- verde/green ral6001

main component sizes

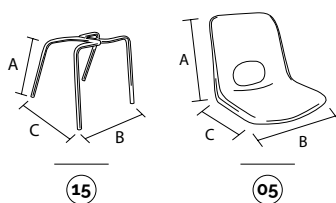

15 teddy-telaio 4 gambe d.22 senza tappi 6° livello
teddy-4 legs frames d.22 without caps 6°level

code	finishing	q.kit	q.pack	a	b	c	kg.x1	vol.x1
110103-053	● nero/black	x1	80	430	435	505	2.40	mc. 0.02
110104-053	● grigio/grey ral2220	x1	80	430	435	505	2.40	mc. 0.02
110110-053	● cromato/chrome	x1	80	430	435	505	2.40	mc. 0.02

11 tappo ø22 testa sferica
cap ø22 spherical head

code	finishing	q.kit
134203-224	● nero/black	x4

05 teddy-scocca intera modello teddy livello 5° - 6°
teddy-plastic shell model teddy level 5° - 6°

code	finishing	q.kit	q.pack	a	b	c	kg.x1	vol.x1
133915-067	● blu/blue ral517	x1	10	375	380	350	0.946	mc. 0.018

06 confezione viti hilo d.5x35 testa svasata a croce zincate
screws auto-thread 5x35 flared cross head zinc for shell fixing package

code	finishing	q.kit	q.pack
117011-070	● zincata/zinc	x4	200



for all colour codes, see page 313

teddy

optional colour codes



shell colour codes



12 scocche in plastica
plastic shells



- 133902-066 rosso/red ral3002
- 133908-066 giallo/yellow ral1021
- 133915-066 blu/blue ral517
- 133916-066 verde/green ral6001



05 scocche in plastica
plastic shells



- 133902-067 rosso/red ral3002
- 133908-067 giallo/yellow ral1021
- 133915-067 blu/blue ral517
- 133916-067 verde/green ral6001





pull



discover more about
Pull Collection

Una seduta dal disegno moderno e accattivante, con monoscocca in plastica disponibile in vari colori.

È ideale per i diversi ambienti Community, in cui siano richieste impilabilità, leggerezza e semplicità di utilizzo: dal Contract, alle aree d'attesa, fino al settore formation.

Oltre alle versioni 4 gambe e a slitta, prevede le versioni girevole e panca.

Chair with a modern and attractive design, featuring a monocoque plastic seat available in a range of colours.

Ideal for different Community environments, where stackability, lightness and ease of use are required: from Contract, to waiting areas, to the training sector.

In addition to the 4-legs and slide versions, it is also available in swivel and bench versions.



**trolley
available**

pull

slide

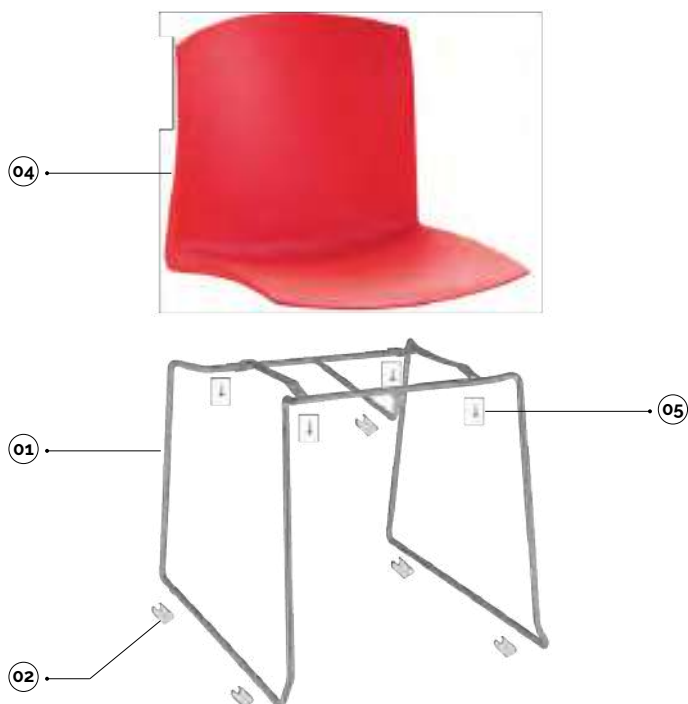

plastic colours

- grigio/grey ral 7035
- nero/black
- arancio/orange ral 2003
- bianco/white 218
- rosso/red 527

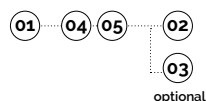

main component sizes

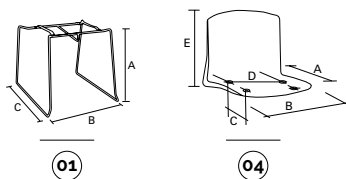

optionals

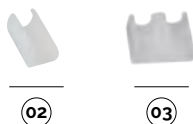

01 speedy-sgabello in tondino per scocca modello pull speedy-round bar for the shell mod.pull

code	finishing	q.kit	q.pack	a	b	c	kg.x1	vol.x1
113410-025	● cromato/chrome	x1	120	450	490	570	3,05	mc. 0,04

02 confezione di basi a pinza antirotazione per tondino colore neutro neutral clips base for wire d.11 package

code	finishing	q.kit	q.pack
137006-070	○ neutro/neutral	x4	200

03 base piana a pinza doppia in pe per tondo per unione sedie double flat clip base for tube

code	finishing	q.kit
134006-021	○ neutro/neutral	x4

04 pull-scocca intera modello pull pull-shell mod. pull

code	finishing	q.kit	q.pack	a	b	c	d	e	kg.x1	vol.x1
133902-026	● rosso/red 527	x1	10	520	450	255	315	393	1,60	mc. 0,021

05 vite tc+combi 6x16 testa cilindrica a croce zincata (vite fissaggio scocca) screw combi 6x16 cylindrical head cross zinc (screw for fix shell)

code	finishing	q.kit
117811-181	○ zincata/zinc	x4

speedy-carrello portasedie con accessori nero speedy-trolley for chairs with accessories black

code	finishing
110803-358	● nero/black



for all colour codes, see page 319

pull

4-legs



plastic colours

- grigio/grey ral 7035
- nero/black
- arancio/orange ral 2003
- bianco/white 218
- rosso/red 527

main component sizes

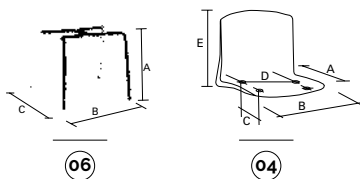

optionals

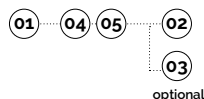

06 pull-sgabello in tubo d.18 per scocca pull-stool tube d.18 for shell

code	finishing	q.kit	q.pack	a	b	c	kg.x1	vol.x1
110603-075	● nero/black	x1	200	450	470	490	2,00	mc. 0,02
110604-095	● grigio/grey	x1	200	450	470	490	2,00	mc. 0,02
110610-045	● cromato/chrome	x1	200	450	470	490	2,00	mc. 0,02

07 confezione puntali tondi d.18 neri black inner round caps d.18 package

code	finishing	q.kit	q.pack
137003-072	● nero/black	x4	200

08 confezione viti hilo 5,5x30 testa svasata a croce zincata (vite per fissaggio scocca) cross screws hilo d.5x30 flared zinc (screw for shell fixing) package

code	finishing	q.kit	q.pack
117011-071	○ zincata/zinc	x4	200

04 pull-scocca intera modello pull pull-shell mod. pull

code	finishing	q.kit	q.pack	a	b	c	d	e	kg.x1	vol.x1
133903-025	● nero/black	x1	10	520	450	255	315	393	1,60	mc. 0,021

09 supporto per impilabilita' scocca neutro support for shell stackability neutral

code	finishing	q.kit	kg.x1
134006-030	○ neutro/neutral	x1	0,025

10 vite hilo tb 5x14 nera hilo cross screw tb 5x14 black

code	finishing	q.kit
117803-155	● nero/black	x1

pull-carrello portasedie con accessori nero pull-trolley for chairs with accessories black

code	finishing
110803-347	● nero/black



for all colour codes, see page 319

pull swivel



plastic colours

- grigio/grey ral 7035
- nero/black
- arancio/orange ral 2003
- bianco/white 218
- rosso/red 527

main component sizes

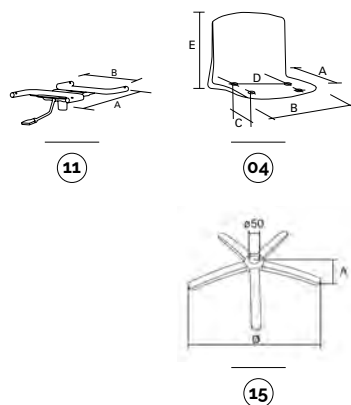

11 04 08 12 13 15
optional

11 supporto girevole a gas per scocca pull swivel metal frame for gas lift for pull shell

code	finishing	q.kit	q.pack	a	b	kg.x1	vol.x1
110903-025	● nero/black	x1	10	315	255	1.40	mc. 0.004

12 confezione tappi copristesta d.18 neri black cover head caps d.18 package

code	finishing	q.kit	q.pack
137003-070	● nero/black	x4	200

04 pull-scocca intera modello pull pull-shell mod. pull

code	finishing	q.kit	q.pack	a	b	c	d	e	kg.x1	vol.x1
133907-025	● arancio/orange ral 2003	x1	10	520	450	255	315	393	1.60	mc. 0.021

08 confezione viti hilo 5,5x30 testa svasata a croce zincata (vite per fissaggio scocca) cross screws hilo d.5x30 flared zinc (screw for shell fixing) package

code	finishing	q.kit	q.pack
117011-071	○ zincata/zinc	x4	200

13 cpg-copertina in plastica per telaio girevole cpg-plastic cover for swivel frame

code	finishing	q.kit	q.pack	a	b	c	d	ø	kg.x1	vol.x1
130903-000	● nero/black	x1	50	60	200	210	167	36	0.1	mc. 0.0015

15 b40 base in metallo d.640 con coprisaldatura b40 metal base d.640 with cover welding

code	finishing	q.kit	q.pack	a	ø	kg.x1	vol.x1
110210-027	● cromato/chrome	x1	5	60	640	2.85	mc. 0.014

optionals

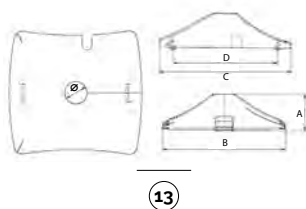

CPG
plastic cover for swivel frame

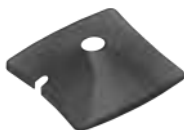

for all colour codes, see page 319

pull bench



plastic colours

- grigio/grey ral 7035
- nero/black
- arancio/orange ral 2003
- bianco/white 218
- rosso/red 527

14 04 08 12

main component sizes

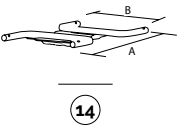

14

14 supporto per attacco scocca pull su panca
bench frame for pull shell

code	finishing	q.kit	q.pack	a	b	kg.x1	vol.x1
110703-085	● nero/black	x1	10	315	255	1.40	mc. 0.004

for the components below, see previous pages



for all colour codes, see below

12 04 08

for the bench components, see page 417

optionals

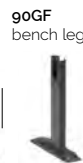
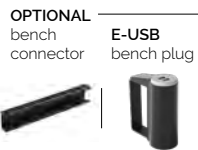

plastic

metal

aluminium

pull optional colour codes



shell colour codes

04 scocche in plastica
plastic shells

- 133904-026 grigio/grey ral 7035
- 133903-025 nero/black
- 133907-025 arancio/orange ral 2003
- 133905-026 bianco/white 218
- 133902-026 rosso/red 527





q5



discover more about
Q5 Collection

Una seduta caratterizzata da una linea elegante e da dettagli distintivi, perfetta espressione del design italiano.

La scocca disponibile in 4 moderni colori può essere abbinata a una serie completa di telai e accessori che rendono Q5 la soluzione ideale per ambienti diversi: dall'Home al Contract, fino alle aree formation, anche grazie alla sua pratica impilabilità.

A seat characterized by elegant lines and distinctive detailing representing a perfect expression of Italian design.

The shell is available in 4 modern colours which can be combined with a complete series of frames and accessories. This makes Q5 the ideal solution for different environments: from Home to Contract, and also training settings, thanks also to its practical stackability.

Plus

- Certificazione ANSI/BIFMA X5.1 (per la versione 4 gambe, la certificazione è disponibile solo con uno speciale telaio da 2 mm di spessore).
- *ANSI/BIFMA X5.1 Certification (for the 4-leg version, certification is only available with a special 2mm thick frame).*



**certified
product**

q5

slide

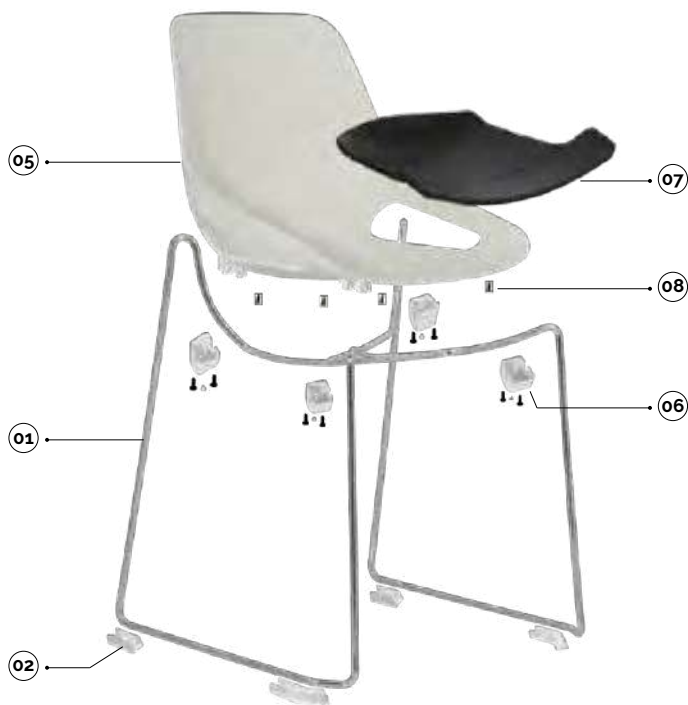

plastic colours

- marrone/brown ral8022
- avorio/ivory ral1013
- giallo/yellow ral1012
- grigio/grey ral7003

main component sizes

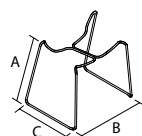
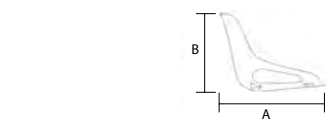

01

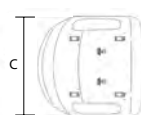

02

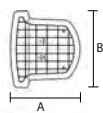

04



02



03



07

optionals

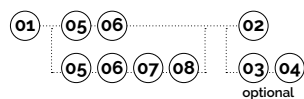

01 q5-telaio slitta in tondino per scocca senza tappi

q5-slide wire frame for shell without caps

code	finishing	q.kit	q.pack	a	b	c	kg.x1	vol.x1
113410-012	● cromato/chrome	x1	100	450	550	510	4,00	mc. 0.04

02 btf-kit piedini

btf-kit feet

code	finishing	q.kit	q.pack	kg.x1
134306-001	○ neutro/neutral	x1	100	0,05

03 btf-a-kit piedini con ganci

btf-a-kit feet with hooks

code	finishing	q.kit	q.pack	kg.x1
134306-002	○ neutro/neutral	x1	100	0,06

04 pttf-tappo per fissaggio pavimento

pttf-cap for fixing to the floor

code	finishing	q.kit	q.pack	kg.x1
134306-003	○ neutro/neutral	x2	100	0,03

05 q5-scozza intera modello q5

q5-shell model q5

code	finishing	q.kit	q.pack	a	b	c	kg.x1	vol.x1
133905-035	○ avorio/ivory ral1013	x1	10	400	400	470	1,60	mc. 0.02

06 q5-confezione accessori per scocca q5

q5-packaging accessories for shell q5

code	finishing	q.kit	q.pack	kg.x1	vol.x1
137005-004	○ avorio/ivory ral1013	x1	10	telaio in tondino/wire frame	0,085 mc. 0.00

07 q5-pannello sedile da tappezzare

q5-panel back for upholstery

code	finishing	q.kit	q.pack	a	b	kg.x1	vol.x1
132203-048	● nero/black	x1	20	390	420	0,52	mc. 0.003

08 confezione viti tbl+ fr. d.5x14 per pannello da tappezzare

screws tbl+ fr.hilo d.5x14 zinc.black (to fix seat panel) package

code	finishing	q.kit	q.pack
117003-071	● nero/black	x4	200



for all colour codes, see page 327

q5 stool

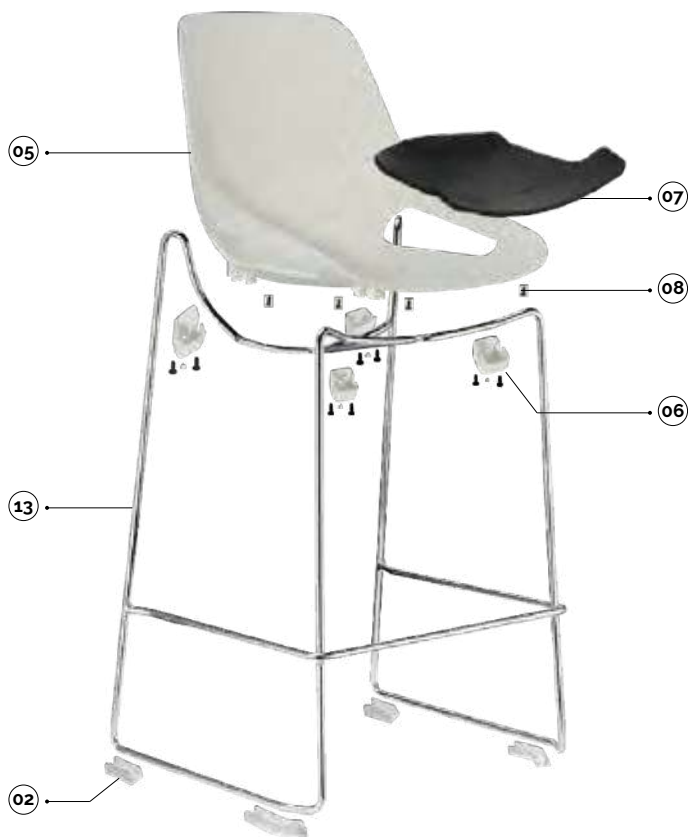

plastic colours

- marrone/brown ral8022
- avorio/ivory ral1013
- giallo/yellow ral1012
- grigio/grey ral7003

main component sizes

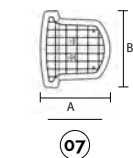
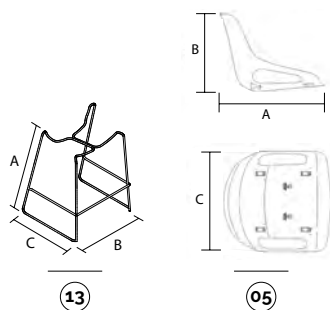

optionals

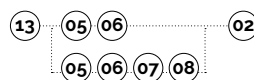

13 q5-sgabello alto in tondino per scocca senza tappi q5-wired frame tall stool for shell without caps

code	finishing	q.kit	q.pack	a	b	c	kg.x1	vol.x1
113410-006	● cromato/chrome	x1	50	700	550	510	6,30	mc. 0,08

02 btf-kit piedini btf-kit feet

code	finishing	q.kit	q.pack	kg.x1
134306-001	○ neutro/neutral	x1	100	0,05

05 q5-scocca intera modello q5 q5-shell model q5

code	finishing	q.kit	q.pack	a	b	c	kg.x1	vol.x1
133905-035	○ avorio/ivory ral1013	x1	10	400	400	470	1,60	mc. 0,02

06 q5-confezione accessori per scocca q5 q5-packaging accessories for shell q5

code	finishing	q.kit	q.pack	kg.x1	vol.x1
137005-004	○ avorio/ivory ral1013	x1	10	telaio in tondino/wire frame	0,085 mc. 0,00

07 q5-pannello sedile da tappezzare q5-panel back for upholstery

code	finishing	q.kit	q.pack	a	b	kg.x1	vol.x1
132203-048	● nero/black	x1	20	390	420	0,52	mc. 0,003

08 confezione viti tbl+ fr. d.5x14 per pannello da tappezzare screws tbl+ fr.hilo d.5x14 zinc.black (to fix seat panel) package

code	finishing	q.kit	q.pack
117003-071	● nero/black	x4	200



for all colour codes, see page 327

q5

4-legs



CERTIFIED BY
BIFMA



plastic colours

- marrone/brown ral8022
- avorio/ivory ral1013
- giallo/yellow ral1012
- grigio/grey ral7003

main component sizes

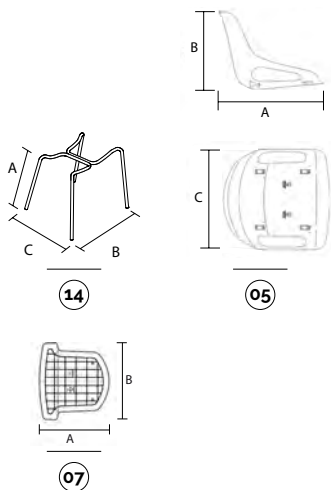

optionals

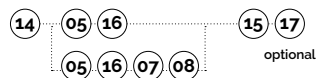
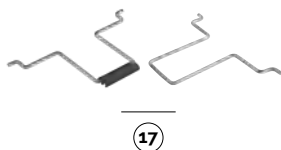

14 q5-telaio 4 gambe in tubo d.18 senza tappi

q5-4 legs frames d.18 without caps

code	finishing	q.kit	q.pack	a	b	c	kg.x1	vol.x1
110603-022	● nero/black	x1	200	450	460	480	1,70	mc. 0,02
110604-022	● grigio/grey	x1	200	450	460	480	1,70	mc. 0,02
110610-135	● cromato/chrome	x1	200	450	460	480	1,70	mc. 0,02

15 confezione puntali tondi d.18 neri

black inner round caps d.18 package

code	finishing	q.kit	q.pack
137003-072	● nero/black	x4	200

05 q5-scocca intera modello q5

q5-shell model q5

code	finishing	q.kit	q.pack	a	b	c	kg.x1	vol.x1
133903-035	● marrone/brown ral8022	x1	10	400	400	470	1,60	mc. 0,02

16 q5-confezione accessori per scocca q5

q5-packaging accessories for shell q5

code	finishing	q.kit	q.pack	kg.x1	vol.x1
137003-003	● marrone/brown ral8022	x1	10	telaio tubo/tube frame	0,085 mc. 0,00

07 q5-pannello sedile da tappezzare

q5-panel back for upholstery

code	finishing	q.kit	q.pack	a	b	kg.x1	vol.x1
132203-048	● nero/black	x1	20	390	420	0,52	mc. 0,003

08 confezione viti tbl+ fr. d.5x14 per pannello da tappezzare

screws tbl+ fr.hilo d.5x14 zinc.black (to fix seat panel) package

code	finishing	q.kit	q.pack
117003-071	● nero/black	x4	200

17 q5-coppia aggancio laterale in tondino + plastica nera

q5-couple round bar lateral hook + black plastic

code	finishing	q.kit	q.pack	kg.x1	vol.x1
113410-004	● cromato/chrome	x1	50	0,15	mc. 0,0004



for all colour codes, see page 327

q5

swivel



plastic colours

- marrone/brown ral8022
- avorio/ivory ral1013
- giallo/yellow ral1012
- grigio/grey ral7003

main component sizes

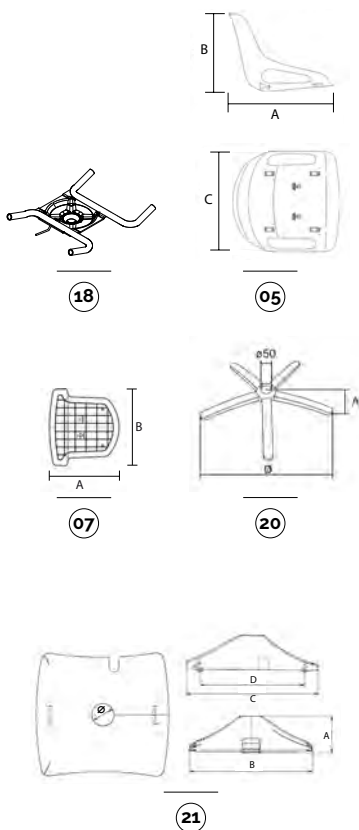

optionals

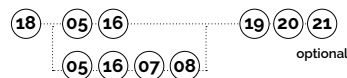

18 q5-supporto girevole a gas per scocca q5

q5-gas lift swislid wire frame for shell without caps

code	finishing	q.kit	q.pack	kg.x1	vol.x1
110903-012	● nero/black	x1	10	1,50	mc. 0,004
110904-012	● grigio/grey	x1	10	1,50	mc. 0,004

19 confezione tappi copritesta d.18 neri

black cover head caps d.18 package

code	finishing	q.kit	q.pack
137003-070	● nero/black	x4	200

05 q5-scozza intera modello q5

q5-shell model q5

code	finishing	q.kit	q.pack	a	b	c	kg.x1	vol.x1
133905-035	○ avorio/ivory ral1013	x1	10	400	400	470	1,60	mc. 0,02

16 q5-confezione accessori per scocca q5

q5-packaging accessories for shell q5

code	finishing	q.kit	q.pack	kg.x1	vol.x1
137005-003	○ avorio/ivory ral1013	x1	10	telaio tubo/tube frame	0,085 mc. 0,00

07 q5-pannello sedile da tappezzare

q5-panel back for upholstery

code	finishing	q.kit	q.pack	a	b	kg.x1	vol.x1
132203-048	● nero/black	x1	20	390	420	0,52	mc. 0,003

08 confezione viti tbl+ fr. d.5x14 per pannello da tappezzare

screws tbl+ fr.hilo d.5x14 zinc.black (to fix seat panel) package

code	finishing	q.kit	q.pack
117003-071	● nero/black	x4	200

20 b40 base in metallo d.640 con coprisaldatura

b40 metal base d.640 with cover welding

code	finishing	q.kit	q.pack	a	ø	kg.x1	vol.x1
110210-027	● cromato/chrome	x1	5	60	640	2,85	mc. 0,014

21 cpq-copertina in plastica per telaio girevole

cpq-plastic cover for swivel frame

code	finishing	q.kit	q.pack	a	b	c	d	ø	kg.x1	vol.x1
130903-000	● nero/black	x1	50	60	200	210	167	36	0,1	mc. 0,0015

CPG
plastic cover for swivel frame

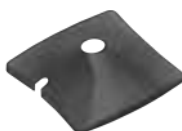

for all colour codes, see page 327

q5 bench



CERTIFIED BY
BIFMA

plastic colours

- marrone/brown ral8022
- avorio/ivory ral1013
- giallo/yellow ral1012
- grigio/grey ral7003

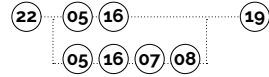

22 q5-supperto per attacco scocca q5 su panca
q5-bench frame for q5 shell

code	finishing	q.kit	q.pack	kg.x1	vol.x1
110703-188	● nero/black	x1	10	1.40	mc. 0.004

main component sizes

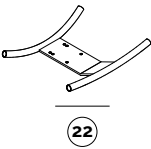

for the components below, see previous pages



for all colour codes, see page 327

for the bench components, see page 417

optionals

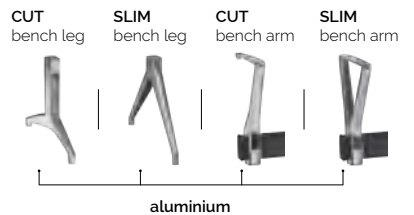
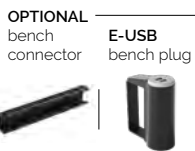

q5

optional colour codes



shell colour codes



05 scocche in plastica plastic shells

- 133903-035 marrone/brown ral8022
- 133905-035 avorio/ivory ral1013
- 133908-035 giallo/yellow ral1012
- 133904-035 grigio/grey ral7003

accessory colour codes



06 accessori in plastica per telaio in tondino plastic accessories for wire frame

- 137003-004 marrone/brown ral8022
- 137005-004 avorio/ivory ral1013
- 137008-004 giallo/yellow ral1012
- 137004-004 grigio/grey ral7003



16 accessori in plastica per telaio a tubo plastic accessories for tube frame

- 137003-003 marrone/brown ral8022
- 137005-003 avorio/ivory ral1013
- 137008-003 giallo/yellow ral1012
- 137004-003 grigio/grey ral7003



oki



discover more about
Oki Collection

Una sedia dalla monoscocca in plastica ampia, confortevole e dai colori vivaci che, unitamente all'ampio foro centrale, le conferiscono un look casual e pratico. È inoltre impilabile e facile da pulire.

Con l'ampia gamma di telai previsti, disponibili in varie finiture, può adattarsi a diverse finalità dall'Home all'Office, fino alle aree Community grazie al telaio in tubo con aggancio laterale, ai braccioli e al porta tavoletta.

A large, comfortable monocoque plastic chair available in range of bright colours which, together with the large central hole, go to create casual and practical look. It is also stackable and easy to clean.

With the wide range of frames available in a selection of finishes, it can be adapted to different contexts, ranging from Home to Office, and even Community areas thanks to the tubular frame with lateral hooks, armrests, and writing tablet holder.

oki

4-legs



plastic colours

- nero/black
- bianco/white 218
- blu/blue 5002

main component sizes

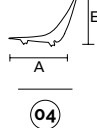
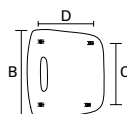
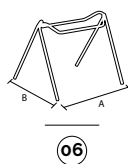

optionals

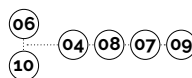
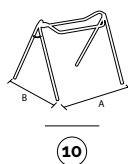

06 oki-sgabello 4 gambe in tubo d.18 senza tappi oki-4 legs stool d.18 tube without caps

code	finishing	q.kit	q.pack	a	b	kg.x1	vol.x1
112703-090	● nero/black	x1	100	560	520	2,70	mc. 0,02
112704-090	● grigio/grey	x1	100	560	520	2,70	mc. 0,02
112710-090	● cromato/chrome	x1	100	560	520	2,70	mc. 0,02

07 tappi-puntale alettato testa sferica d.18 nero inner caps-black spherical cap d.18

code	finishing	q.kit
134203-181	● nero/black	x4

08 confezione viti hilo d.5x35 testa svasata a croce zincate (vite fissaggio scocca) screws auto-thread 5x35 flared cross head zinc for shell fixing package

code	finishing	q.kit	q.pack
117011-070	○ zincata/zinc	x4	200

04 oki-scocca intera modello oki oki-shell for oki model

code	finishing	q.kit	q.pack	a	b	c	d	e	kg.x1	vol.x1
133905-050	○ bianco/white 218	x1	10	525	530	209	306	395	1,80	mc. 0,025

09 supporto per impilabilità 'scocca oki neutro support for stackability neutral shell oki

code	finishing	q.kit
134006-031	○ neutro/neutral	x1

10 oki-sgabello 4 gambe in tubo d.18 con aggancio laterale senza tappi oki-4 legs stool d.18 tube with lateral hooks without caps

code	finishing	q.kit	q.pack	a	b	kg.x1	vol.x1
112703-091	● nero/black	x1	100	560	520	2,70	mc. 0,02
112704-091	● grigio/grey	x1	100	560	520	2,70	mc. 0,02
112710-091	● cromato/chrome	x1	100	560	520	2,70	mc. 0,02

frame optional
4 legs stool d.18 tube with lateral hooks



10



for all colour codes, see page 333

oki

swivel



plastic colours

- nero/black
- bianco/white 218
- blu/blue 5002

main component sizes

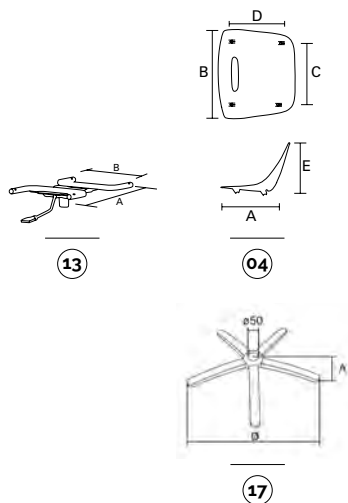

optionals

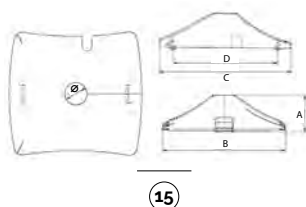

13 04 08 14 15 17
optional

13 oki-supporto girevole a gas per scocca oki
oki-gas lift swivel metal frame for oki shell

code	finishing	q.kit	q.pack	a	b	kg.x1	vol.x1
110903-010	● nero/black	x1	10	306	209	1,30	mc. 0.04

14 confezione tappi copritesta d.18 neri
black cover head caps d.18 package

code	finishing	q.kit	q.pack
137003-070	● nero/black	x4	200

04 oki-scocca intera modello oki
oki-shell for oki model

code	finishing	q.kit	q.pack	a	b	c	d	e	kg.x1	vol.x1
133915-050	● blu/blue 5002	x1	10	525	530	209	306	395	1,80	mc. 0.025

08 confezione viti hilo d.5x35 testa svasata a croce zincate (vite fissaggio scocca)
screws auto-thread 5x35 flared cross head zinc for shell fixing package

code	finishing	q.kit	q.pack
117011-070	○ zincata/zinc	x4	200

15 cpg-copertina in plastica per telaio girevole
cpg-plastic cover for swivel frame

code	finishing	q.kit	q.pack	a	b	c	d	ø	kg.x1	vol.x1
130903-000	● nero/black	x1	50	60	200	210	167	36	0,1	mc. 0.0015

17 b40 base in metallo d.640 con coprisaldatura
b40 metal base d.640 with cover welding

code	finishing	q.kit	q.pack	a	ø	kg.x1	vol.x1
110210-027	● cromato/chrome	x1	5	60	640	2,85	mc. 0.014

CPG
plastic cover for swivel frame



for all colour codes, see page 333

oki

bench



plastic colours

- nero/black
- bianco/white 218
- blu/blue 5002

16 04 08 14

16 oki-supporto per attacco scocca oki su panca
smile-bench frame for oki shell

code	finishing	q.kit	q.pack	a	b	kg.x1	vol.x1
110703-053	● nero/black	x1	15	306	209	1.40	mc. 0.004

main component sizes

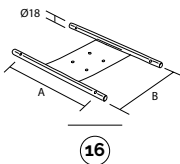

for the components below, see previous pages

04 08 14



for all colour codes, see page 333

for the bench components, see page 417

optionals

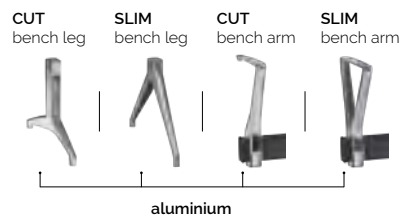



shell colour codes



04 scocca in plastica
plastic shells

- 133903-050 nero/black
- 133905-050 bianco/white 218
- 133915-050 blu/blue 5002





race



discover more about
Race Collection

Una monoscocca dal design geometrico e moderno, disponibile in 8 vivaci colori; opzionale il pannellino da tappezzare.

L'ampia offerta di telai, che vanno dallo sgabello alla panca, disponibili in varie finiture, la rendono capace di adattarsi a ogni contesto, soprattutto in ambienti Contract e Community anche grazie alla pratica impilabilità.

A monocoque chair featuring a geometric and modern design, available in 8 bright colours; optional seat panel can be upholstered.

The wide range of frames, ranging from stool to bench, available in various finishes, mean it can be adapted to any context, especially in Contract and Community environments, and its stackability means it is also highly practical.



**trolley
available**

race

slide

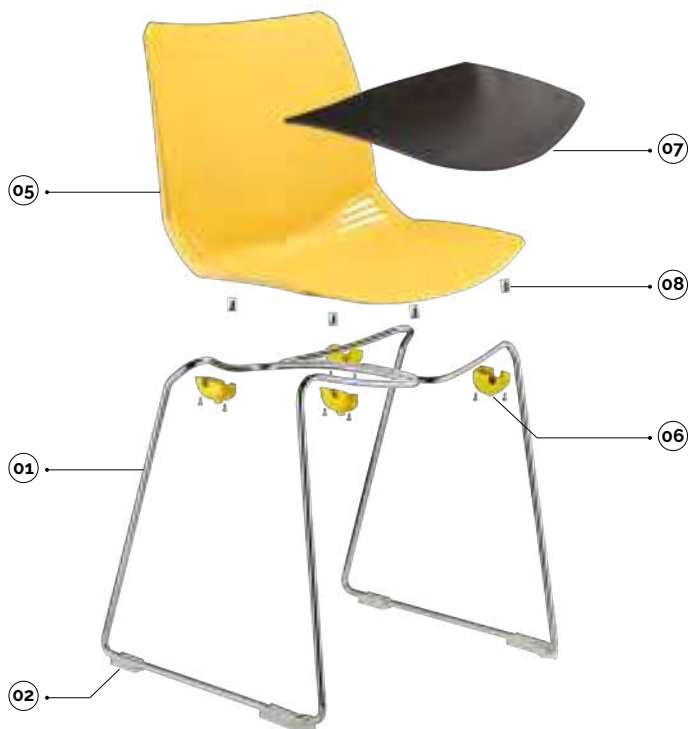

plastic colours

- blu/blue ral5002
- arancio/orange ral2009
- viola/purple 145
- verde/green 736
- avorio/ivory ral1013
- grigio/grey ral7003
- giallo/yellow ral1012
- marrone/brown ral8022

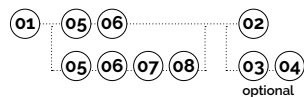

main component sizes

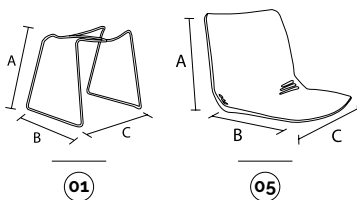

optionals

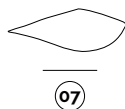

01 race-telaio slitta in tondino per scocca senza tappi
race-slide wire frame for shell without caps

code	finishing	q.kit	q.pack	a	b	c	kg.x1	vol.x1
113410-065	● cromato/chrome	x1	100	460	500	470	3,20	mc. 0.026

02 btf-kit piedini
btf-kit feet

code	finishing	q.kit	q.pack	kg.x1
134306-001	○ neutro/neutral	x1	100	0,05

03 btfa-kit piedini con ganci
btfa-kit feet with hooks

code	finishing	q.kit	q.pack	kg.x1
134306-002	○ neutro/neutral	x1	100	0,06

04 ppthf-tappo per fissaggio pavimento
ppthf-cap for fixing to the floor

code	finishing	q.kit	q.pack	kg.x1
134306-003	○ neutro/neutral	x2	100	0,03

05 race-scocca intera modello race
race-plastic shell model race

code	finishing	q.kit	q.pack	a	b	c	kg.x1	vol.x1
133908-012	● giallo/yellow ral1012	x1	10	380	410	450	1,60	mc. 0.02

06 race-confezione accessori per scocca race
race-accessory pack for shell race

code	finishing	q.kit	q.pack	kg.x1	vol.x1
137008-006	● giallo/yellow ral1012	x1	10	telaio in tondino/wire frame	0,085 mc. 0.001

07 race-pannello sedile da tappezzare
race-back panel for upholstery

code	finishing	q.kit	q.pack	kg.x1	vol.x1
132203-049	● nero/black	x1	20	0,53	mc. 0.003

08 confezione viti tbl+ fr. d.5x14 per pannello da tappezzare
screws tbl+ fr.hilo d.5x14 zinc.black (to fix seat panel) package

code	finishing	q.kit	q.pack
117003-071	● nero/black	x4	200

race-carrello portasedie con accessori verniciato nero
race-trolley for chairs with accessories painted black

code	finishing	q.kit
110803-348	● nero/black	x1



for all colour codes, see page 341

race

stool

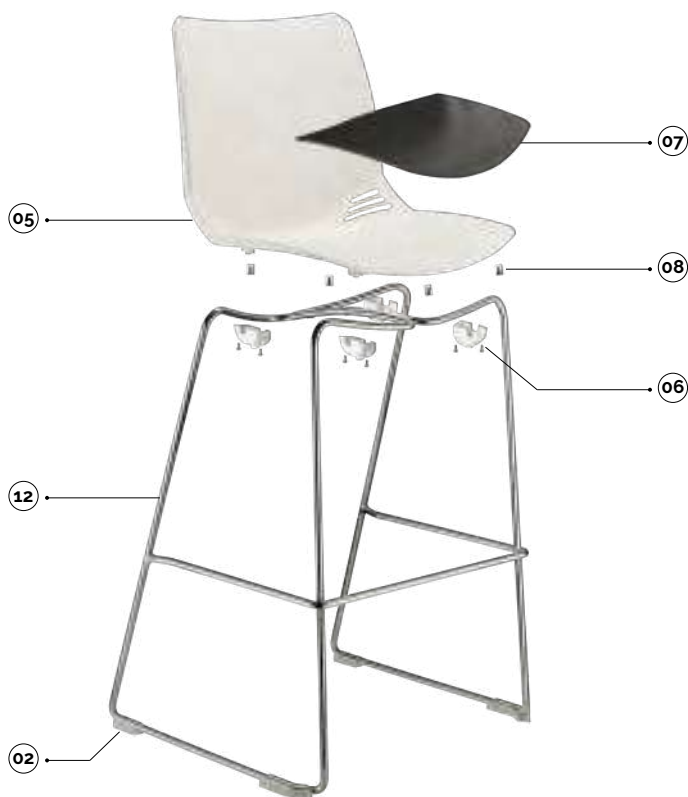

plastic colours

- blu/blue ral5002
- arancio/orange ral2009
- viola/purple 145
- verde/green 736
- avorio/ivory ral1013
- grigio/grey ral7003
- giallo/yellow ral1012
- marrone/brown ral8022

main component sizes

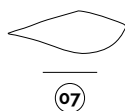
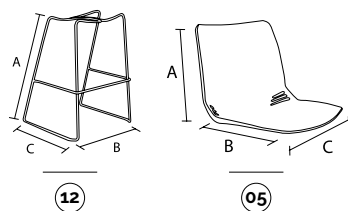

optionals

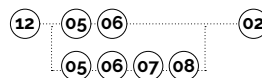

12 race-sgabello alto in tondino per scocca senza tappi race-wire high bar stool for shell without caps

code	finishing	q.kit	q.pack	a	b	c	kg.x1	vol.x1
113410-066	● cromato/chrome	x1	50	700	500	550	5,85	mc. 0.08

02 btf-kit piedini btf-kit feet

code	finishing	q.kit	q.pack	kg.x1
134306-001	○ neutro/neutral	x1	100	0,05

05 race-scocca intera modello race race-plastic shell model race

code	finishing	q.kit	q.pack	a	b	c	kg.x1	vol.x1
133905-012	○ avorio/ivory ral1013	x1	10	380	410	450	1,60	mc. 0.02

06 race-confezione accessori per scocca race race-accessory pack for shell race

code	finishing	q.kit	q.pack	kg.x1	vol.x1
137005-006	○ avorio/ivory ral1013	x1	10	telaio in tondino/wire frame	0,085 mc. 0.001

07 race-pannello sedile da tappezzare race-back panel for upholstery

code	finishing	q.kit	q.pack	kg.x1	vol.x1
132203-049	● nero/black	x1	20	0,53	mc. 0.003

08 confezione viti tbl+ fr. d.5x14 per pannello da tappezzare screws tbl+ fr.hilo d.5x14 zinc.black (to fix seat panel) package

code	finishing	q.kit	q.pack	kg.x1	vol.x1
117003-071	● nero/black	x4	200		



for all colour codes, see page 341

race

4-legs



plastic colours

- blu/blue ral5002
- arancio/orange ral2009
- viola/purple 145
- verde/green 736
- avorio/ivory ral1013
- grigio/grey ral7003
- giallo/yellow ral1012
- marrone/brown ral8022

main component sizes

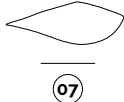
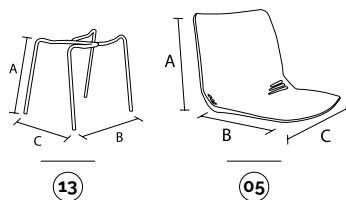

optionals

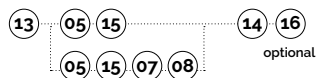
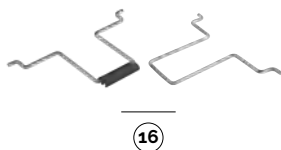

13 race-telaio 4 gambe in tubo d.18 senza tappi race-4 legs frame d.18 without caps

code	finishing	q.kit	q.pack	a	b	c	kg.x1	vol.x1
112703-015	● nero/black	x1	200	460	500	470	1.85	mc. 0.014
112707-015	● marrone/brown ral8022	x1	200	460	500	470	1.85	mc. 0.014
112704-015	● grigio/gray ral7003	x1	200	460	500	470	1.85	mc. 0.014
112705-015	○ avorio/ivory ral1013	x1	200	460	500	470	1.85	mc. 0.014
112710-015	● cromato/chrome	x1	200	460	500	470	1.85	mc. 0.014

14 confezione puntali tondi d.18 neri black inner round caps d.18 package

code	finishing	q.kit	q.pack
137003-072	● nero/black	x4	200
134205-181	○ bianco/white	x4	

05 race-scocca intera modello race race-plastic shell model race

code	finishing	q.kit	q.pack	a	b	c	kg.x1	vol.x1
133916-012	● verde/green 736	x1	10	380	410	450	1.60	mc. 0.02

15 race-confezione accessori per scocca race race-accessory pack for shell race

code	finishing	q.kit	q.pack	kg.x1	vol.x1
137016-005	● verde/green 736	x1	10	telaio tubo/tube frame	0,085 mc. 0.001

07 race-pannello sedile da tappezzare race-back panel for upholstery

code	finishing	q.kit	q.pack	kg.x1	vol.x1
132203-049	● nero/black	x1	20	0,53	mc. 0.003

08 confezione viti tbl+ fr. d.5x14 per pannello da tappezzare screws tbl+ fr.hilo d.5x14 zinc.black (to fix seat panel) package

code	finishing	q.kit	q.pack
117003-071	● nero/black	x4	200

16 race-coppia agganci laterale in tondino + plastica race-pair side wire hooks + plastic

code	finishing	q.kit	q.pack	kg.x1	vol.x1
113410-004	● cromato/chrome	x1	50	0,15	mc. 0.0004



for all colour codes, see page 341

race

swivel



plastic colours

- blu/blue ral5002
- arancio/orange ral2009
- viola/purple 145
- verde/green 736
- avorio/ivory ral1013
- grigio/grey ral7003
- giallo/yellow ral1012
- marrone/brown ral8022

main component sizes

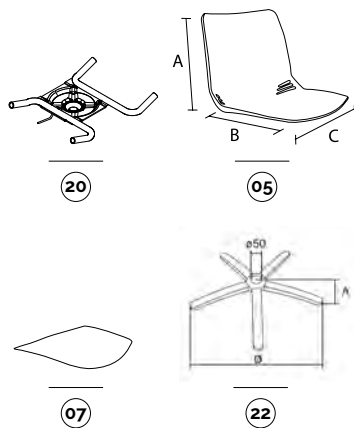

optionals

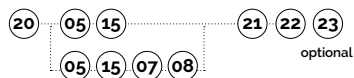
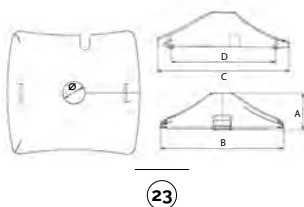

20 race-supperto girevole a gas per scocca race

race-swivel frame for race shell

code	finishing	q.kit	q.pack	kg.x1	vol.x1
110903-070	● nero/black	x1	8	1.40	mc. 0.005
110904-070	● grigio/grey ral7003	x1	8	1.40	mc. 0.005

21 confezione tappi copritesta d.18 neri

black cover head caps d.18 package

code	finishing	q.kit	q.pack
137003-070	● nero/black	x4	200

05 race-scocca intera modello race

race-plastic shell model race

code	finishing	q.kit	q.pack	a	b	c	kg.x1	vol.x1
133905-012	○ avorio/ivory ral1013	x1	10	380	410	450	1.60	mc. 0.02

15 race-confezione accessori per scocca race

race-accessory pack for shell race

code	finishing	q.kit	q.pack	kg.x1	vol.x1
137005-005	○ avorio/ivory ral1013	x1	10	telaio tubo/tube frame	0,085 mc. 0.001

07 race-pannello sedile da tappezzare

race-back panel for upholstery

code	finishing	q.kit	q.pack	kg.x1	vol.x1
132203-049	● nero/black	x1	20	0.53	mc. 0.003

08 confezione viti tbl+ fr. d.5x14 per pannello da tappezzare

screws tbl+ fr.hilo d.5x14 zinc.black (to fix seat panel) package

code	finishing	q.kit	q.pack
117003-071	● nero/black	x4	200

22 b40 base in metallo d.640 con coprisaldatura

b40 metal base d.640 with cover welding

code	finishing	q.kit	q.pack	a	ø	kg.x1	vol.x1
110210-027	● cromato/chrome	x1	5	60	640	2.85	mc. 0.014

23 cpg-copertina in plastica per telaio girevole

cpg-plastic cover for swivel frame

code	finishing	q.kit	q.pack	a	b	c	d	ø	kg.x1	vol.x1
130903-000	● nero/black	x1	50	60	200	210	167	36	0.1	mc. 0.0015

CPG
plastic cover for swivel frame

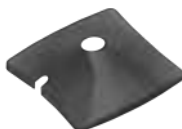

for all colour codes, see page 341

race

bench



plastic colours

- blu/blue ral5002
- arancio/orange ral2009
- viola/purple 145
- verde/green 736
- avorio/ivory ral1013
- grigio/grey ral7003
- giallo/yellow ral1012
- marrone/brown ral8022

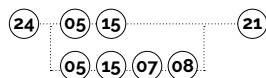

main component sizes

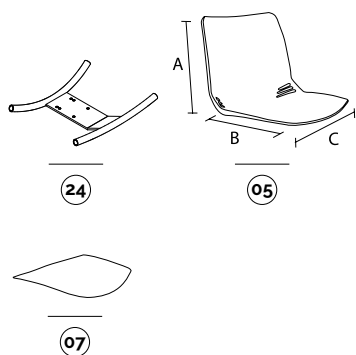

24 race-supporto per attacco scocca race su panca race-bench frame for race shell

code	finishing	q.kit	q.pack	kg.x1	vol.x1
110703-210	● nero/black	x1	15	1,30	mc. 0.004

21 confezione tappi copritesta d.18 neri black cover head caps d.18 package

code	finishing	q.kit	q.pack
137003-070	● nero/black	x4	200

05 race-scozza intera modello race race-plastic shell model race

code	finishing	q.kit	q.pack	a	b	c	kg.x1	vol.x1
133905-012	○ avorio/ivory ral1013	x1	10	380	410	450	1,60	mc. 0.02

15 race-confezione accessori per scocca race race-accessory pack for shell race

code	finishing	q.kit	q.pack	kg.x1	vol.x1
137005-005	○ avorio/ivory ral1013	x1	10	telaio tubo/tube frame	0,085 mc. 0.001

07 race-pannello sedile da tappezzare race-back panel for upholstery

code	finishing	q.kit	q.pack	kg.x1	vol.x1
132203-049	● nero/black	x1	20	0,53	mc. 0.003

08 confezione viti tbl+ fr. d.5x14 per pannello da tappezzare screws tbl+ fr.hilo d.5x14 zinc.black (to fix seat panel) package

code	finishing	q.kit	q.pack
117003-071	● nero/black	x4	200

for the bench components, see page 417



for all colour codes, see page 341

optionals

OPTIONAL
bench
connector



E-USB
bench plug



JIM
bench leg



plastic

90GM
bench leg



90GF
bench leg



91GM **NEW**
bench leg



100GM
bench leg



200GM
bench leg



PIONEER
bench arm



metal

CUT
bench leg



SLIM
bench leg



CUT
bench arm



SLIM
bench arm



aluminium

race

optional colour codes

shell colour codes



05 scocche in plastica
plastic shells

- 133915-012 blu/blue ral5002
- 133907-012 arancio/orange ral2009
- 133914-012 viola/purple 145
- 133916-012 verde/green 736
- 133905-012 avorio/ivory ral1013
- 133904-012 grigio/grey ral7003
- 133908-012 giallo/yellow ral1012
- 133907-013 marrone/brown ral8022



accessory colour codes



06 accessori in plastica per telaio in tondino
plastic accessories for wire frame

- 137015-006 blu/blue ral5002
- 137007-007 arancio/orange ral2009
- 137014-006 viola/purple 145
- 137016-006 verde/green 736
- 137005-006 avorio/ivory ral1013
- 137004-006 grigio/grey ral7003
- 137008-006 giallo/yellow ral1012
- 137007-008 marrone/brown ral8022



15 accessori in plastica per telaio in tubo
plastic accessories for tube frame

- 137015-005 blu/blue ral5002
- 137007-005 arancio/orange ral2009
- 137014-005 viola/purple 145
- 137016-005 verde/green 736
- 137005-005 avorio/ivory ral1013
- 137004-005 grigio/grey ral7003
- 137008-005 giallo/yellow ral1012
- 137007-006 marrone/brown ral8022

armrest colour codes



10 braccioli in plastica per telaio a filo
plastic armrests for wire frame

- 131704-019 grigio/grey ral7003
- 131703-019 nero/black
- 131705-019 avorio/ivory ral1013



18 braccioli in plastica per telaio 4 gambe
plastic armrests for 4-legs frame

- 131704-017 grigio/grey ral7003
- 131703-017 nero/black
- 131705-017 avorio/ivory ral1013





smile



discover more about
Smile Collection

Una monocoocca in plastica ampia, confortevole e avvolgente, caratterizzata da un design distintivo e solido, grazie anche alla gamma di colori vivaci in cui viene proposta.

L'ampia scelta di telai, che vanno dallo sgabello alla panca, disponibili in varie finiture, le permettono di adattarsi a ogni tipo di ambiente, dall'Home all'Office. Grazie all'impilabilità e alla facilità di pulizia, Smile si adatta bene anche all'ambiente Community.

A monocoque plastic chair with an ample, comfortable and enveloping seat, characterized by a distinctive and solid design, thanks also to the range of bright colour options on offer.

The wide selection of frames ranges from stool to bench versions, and are available in various finishes, thus enabling it to be adapted to any type of environment, from Home to Office. Thanks to its stackability and ease of cleaning, Smile also adapts well to Community environments.

smile

slide

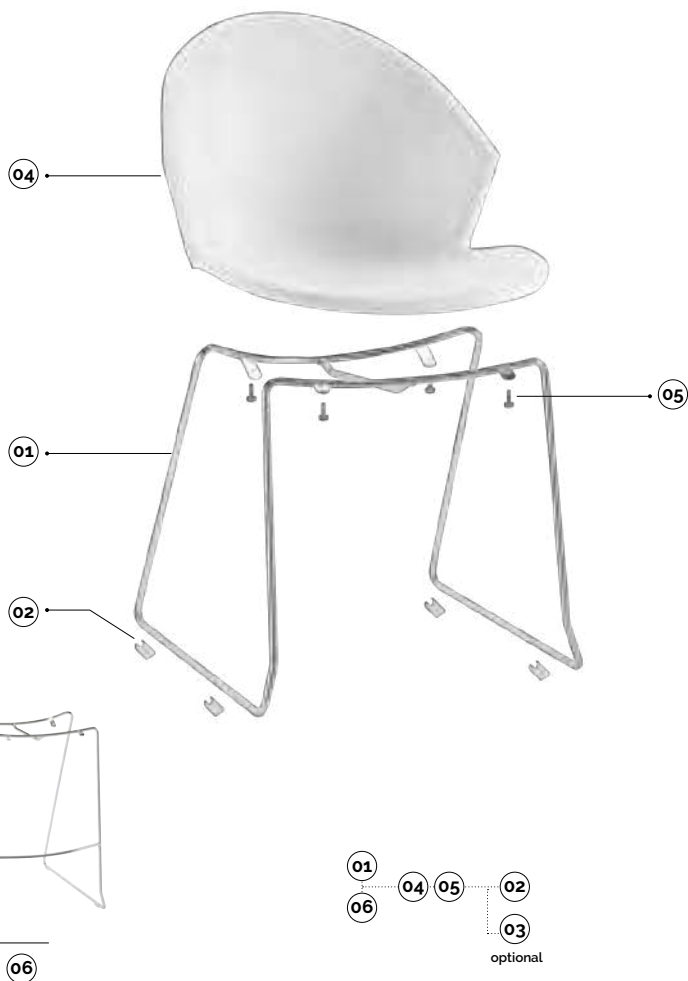

plastic colours

- nero/black
- bianco/white 218
- blu/blue 5002

main component sizes

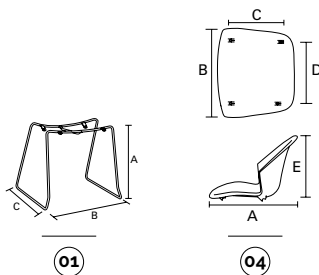

optionals

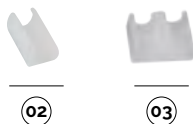

01 smile-sgabello in tondino cromato per scocca senza tappi
smile-chrome wired frame stool for shell without caps

code	finishing	q.kit	q.pack	a	b	c	kg.x1	vol.x1
113410-018	● cromato/chrome	x1	100	450	500	500	3,20	mc. 0.04

02 confezione di basi a pinza antirotazione per tondino colore neutro
neutral clips base for wire d.11 package

code	finishing	q.kit	q.pack
137006-070	○ neutro/neutral	x4	200

03 base piana a pinza doppia in pe per tondo per unione sedie
double flat clip base for tube

code	finishing	q.kit
134006-021	○ neutro/neutral	x4

04 smile-scocca intera modello smile
smile-shell model smile

code	finishing		q.kit	q.pack	a	b	c	d	e	kg.x1	vol.x1
133905-053	○ bianco/white	218	x1	10	540	510	235	277	395	1,50	mc. 0.015

05 vite autoflettante 5,5x19 testa cilindrica a croce zincata (vite fissaggio scocca)
auto-thread screw 5,5x19 cylindrical head cross zinc (screw for shell fixing)

code	finishing	q.kit	q.pack
110603-630	○ zincata/zinc	x4	60

06 smile-sgabello alto in tondino cromato per scocca senza tappi
smile-chrome wired frame tall stool for shell without caps

code	finishing	q.kit	q.pack	a	b	c	kg.x1	vol.x1
113410-019	● cromato/chrome	x1	50	700	500	560	5,00	mc. 0.08



for all colour codes, see page 347

smile

4-legs



plastic colours

- nero/black
- bianco/white 218
- blu/blue 5002

07 04 09 08

main component sizes

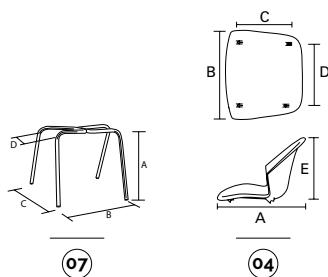

07 smile-sgabello 4 gambe in tubo d.20 senza tappi
smile-4 legs stool d.20 without caps

code	finishing	q.kit	q.pack	a	b	c	d	kg.x1	vol.x1
112703-030	● nero/black	x1	150	430	440	540	260	1,92	mc. 0,02
112704-030	○ grigio/grey	x1	150	430	440	540	260	1,92	mc. 0,02
112710-030	● cromato/chrome	x1	150	430	440	540	260	1,92	mc. 0,02

08 tappi-puntale alettato d.20 nero
inner caps-black round insert cap d.20

code	finishing	q.kit
134203-200	● nero/black	x4

04 smile-scocca intera modello smile
smile-shell model smile

code	finishing	q.kit	q.pack	a	b	c	d	e	kg.x1	vol.x1
133905-053	○ bianco/white 218	x1	10	540	510	235	277	395	1,50	mc. 0,015

09 confezione viti hilo d.5x35 testa svasata a croce zincate (vite fissaggio scocca)
screws auto-thread 5x35 flared cross head zinc for shell fixing package

code	finishing	q.kit	q.pack
117011-070	○ zincata/zinc	x4	200



for all colour codes, see page 347

smile

swivel



plastic colours

- nero/black
- bianco/white 218
- blu/blue 5002

10 04 09 11 12
optional

main component sizes

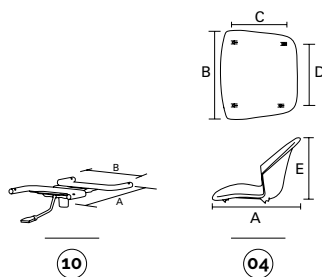

optionals

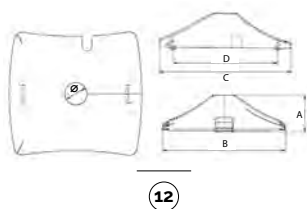

10 smile-supporto girevole a gas per scocca smile
smile-gas lift swivel metal frame for smile shell

code	finishing	q.kit	q.pack	a	b	kg.x1	vol.x1
110903-030	● nero/black	x1	10	277	235	1.40	mc. 0,004
110904-008	● grigio/grey	x1	10	277	235	1.40	mc. 0,004

11 tappi-tappo copritesta alettato d.20 nero
caps-cover head d.20 black

code	finishing	q.kit
134103-200	● nero/black	x4

04 smile-scocca intera modello smile
smile-shell model smile

code	finishing	q.kit	q.pack	a	b	c	d	e	kg.x1	vol.x1
133915-053	● blu/blue 5002	x1	10	540	510	235	277	395	1.50	mc. 0,015

09 confezione viti hilo 5x35 testa svasata a croce zincate (vite per fissaggio scocca)
screws auto-thread 5x35 flared cross head zinc (screw for shell fixing) package

code	finishing	q.kit	q.pack
117011-070	● zincata/zinc	x4	200

12 cpg-copertina in plastica per telaio girevole
cpg-plastic cover for swivel frame

code	finishing	q.kit	q.pack	a	b	c	d	ø	kg.x1	vol.x1
130903-000	● nero/black	x1	50	60	200	210	167	36	0.1	mc. 0,0015

CPG
plastic cover for swivel frame



for all colour codes, see page 347

smile

bench



plastic colours

- nero/black
- bianco/white 218
- blu/blue 5002

13 04 09 11

13 smile-supporto per attacco scocca smile su panca
smile-bench frame for oki shell

code	finishing	q.kit	q.pack	a	b	kg.x1	vol.x1
110703-087	● nero/black	x1	10	277	235	1.40	mc. 0.004

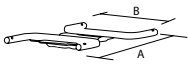

13

for the components below, see previous pages



for all colour codes, see below

04 09 11

main component sizes

for the bench components, see page 417

optionals

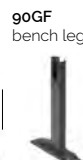
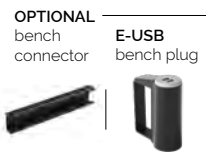

smile

optional colour codes



shell colour codes

04 scocche in plastica
plastic shells

- 133903-053 nero/black
- 133905-053 bianco/white 218
- 133915-053 blu/blue 5002





eden



discover more about
Eden Collection

Grazie al design semplice ed essenziale può adattarsi a contesti molto diversi tra loro: dall' Educational all'ambiente Home.

Sia il sedile sia lo schienale sono disponibili in diverse colorazioni.

Eden è impilabile e disponibile anche nella versione sgabello.

With its simple and essential design, Eden can be adapted to a broad range of settings, from Educational to Home environments.

Both the seat and backrest are available in a range of different colours.

Eden is stackable and also available in a stool version.

eden

4-legs

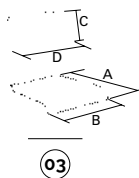
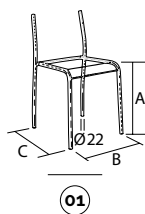
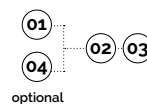

main component sizes

01 eden-telaio fisso senza tappi
eden-fixed frame without caps

code	finishing	q.kit	q.pack	a	b	c	kg.x1	vol.x1
111903-030	● nero/black	x1	100	470	420	460	3,00	mc. 0.03
111904-020	● grigio/grey	x1	100	470	420	460	3,00	mc. 0.03
111910-030	● cromato/chrome	x1	100	470	420	460	3,00	mc. 0.03

02 confezione puntali tondi d.22 neri
black inner round flat caps d.22 package

code	finishing	q.kit	q.pack
137003-073	● nero/black	x4	200

03 eden-sedile e schienale in plastica
eden-plastic seat and back

code	finishing	q.kit	q.pack	a	b	c	d	kg.x1	vol.x1
134003-100	● nero/black	x1	20	400	390	180	400	1,50	mc. 0.013
134015-020	● blu/blue	x1	20	400	390	180	400	1,50	mc. 0.013
134005-020	○ avorio/ivory	x1	20	400	390	180	400	1,50	mc. 0.013

eden

4-legs/frame option

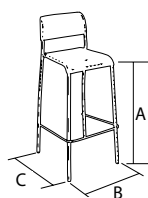

04

main component sizes

04 eden-sgabello alto fisso senza tappi
eden-fixed stool without caps

code	finishing	q.kit	q.pack	a	b	c	kg.x1	vol.x1
111903-032	● nero/black	x1	50	720	420	460	4.10	mc. 0.09
111904-022	● grigio/grey	x1	50	720	420	460	4.10	mc. 0.09
111910-029	● cromato/chrome	x1	50	720	420	460	4.10	mc. 0.09

02 confezione puntali tondi d.22 neri
black inner round flat caps d.22 package

code	finishing	q.kit	q.pack
137003-073	● nero/black	x4	200

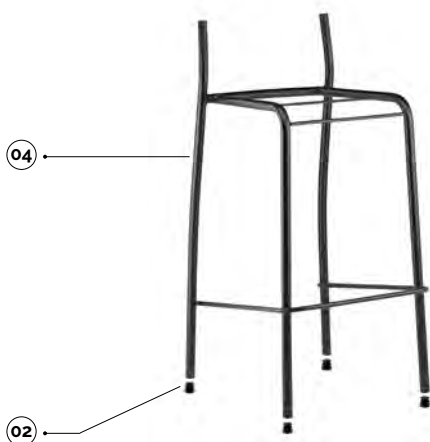



paco



discover more about
Paco Collection

Uno sgabello dallo stile classico, dotato di una comoda seduta in monoscocca di plastica, disponibile in tre diverse colorazioni, e di una struttura sagomata in acciaio, cromata o grigia.

Paco è pratico e versatile, pensato per gli ambienti Contract.

A classically-styled stool, featuring a comfortable monocoque plastic seat.

Available in three different colours, it features a contoured frame in steel, chrome or grey.

Paco is practical and versatile, designed for Contract environments.

paco

4-legs



plastic colours

- antracite/grey ppl17
- beige/beige ppl09
- blu/blue ppl14

01 02

main component sizes

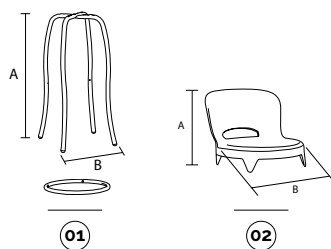

01 paco-telaio smontato per sgabello alto con accessori per il montaggio
paco-frame not assembled for high stool with accessories for assemblage

code	finishing	q.kit	q.pack	a	b	kg.x1	vol.x1
110604-090	● grigio/grey	x1	6	800	370	3,45	mc. 0,02
110610-080	● cromato/chrome	x1	6	800	370	3,45	mc. 0,02

02 paco-scocca intera in plastica
paco-plastic shell

code	finishing	q.kit	q.pack	a	b	kg.x1	vol.x1
133904-025	● antracite/grey ppl17	x1	10	230	380	1,38	mc. 0,02
133905-040	● beige/beige ppl09	x1	10	230	380	1,38	mc. 0,02
133915-040	● blu/blue ppl14	x1	10	230	380	1,38	mc. 0,02

lo sgabello standard comprende la confezione accessori per il montaggio
the kit of accessories for the assemblage is included with the stool

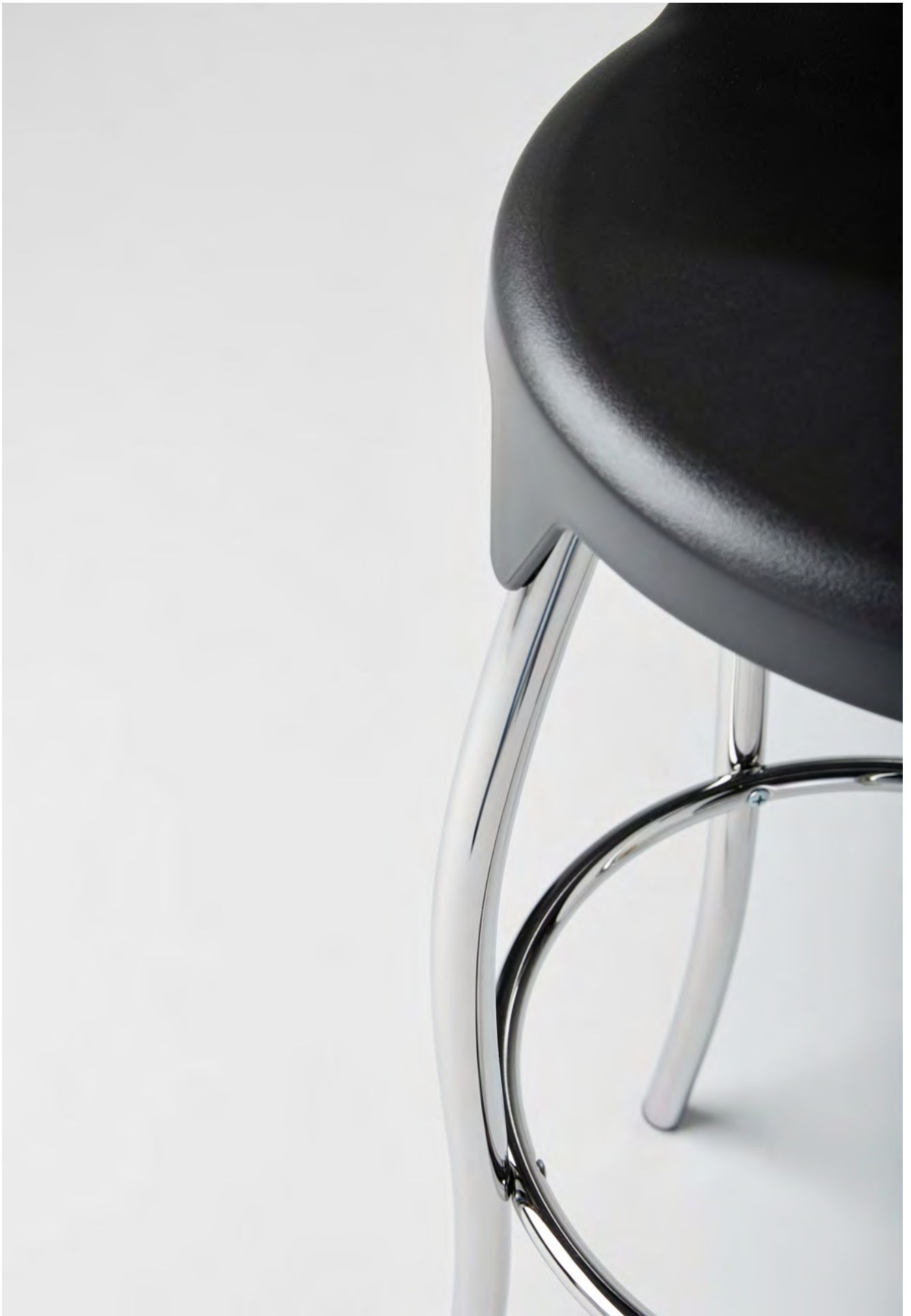



vicenza



discover more about
Vicenza Collection

La seduta dal design minimal ed essenziale.

La scocca in plastica, disponibile in vari colori, è abbinabile a un'ampia e completa serie di telai, che la rendono adatta ad ambienti diversi, soprattutto Community.

È impilabile e disponibile anche con agganci laterali e nella versione con tavoletta.

Chair with a minimal and essential design.

The plastic seat shell is available in a selection of colours, and can be combined with a wide and complete series of frames, thus making it suitable for different environments, especially Community settings.

It is stackable and also available with lateral hooks and in a version with writing tablet.

Plus

• Certificazione EN 16139:2013+AC2013 Livello 1.

• EN 16139:2013+AC2013 Level 1 Certification.



**trolley
available**



**certified
product**

vicenza

4-legs



plastic colours

- rosso/red ral 3002
- nero/black
- blu/blue ral 5002

main component sizes

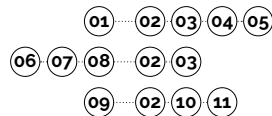
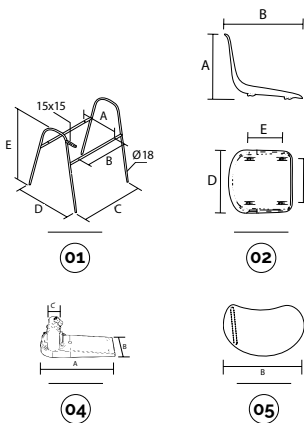

01 vicenza-sgabello per scocca vicenza con porta tav. e bracc. in tubo $\varnothing 18$ tappi montati
vicenza-stool for vicenza with mechanism for little table and arms shell pipe $\varnothing 18$ inner feet caps assembled

code	finishing	q.kit	q.pack	a	b	c	d	e	kg.x1	vol.x1
111903-007	● nero/black	x1	80	255	315	486	500	630	2,50	mc. 0,040
111910-012	● cromato/chrome	x1	80	255	315	486	500	630	2,50	mc. 0,040

02 vicenza-scocca intera
vicenza-plastic shell

code	finishing	q.kit	q.pack	a	b	c	d	e	kg.x1	vol.x1
133902-002	● rosso/red ral 3002	x2	12	395	470	315	430	255	1,30	mc. 0,014

03 confezione viti hilo d.5x35 testa svasata a croce zincate (vite fissaggio scocca)
screws auto-thread 5x35 flared cross head zinc for shell fixing package

code	finishing	q.kit	q.pack
117011-070	● zincata/zinc	x4	200

04 spt2-snodo per tavoletta in tempoplastica
spt2-mechanism for writing tablet

code	finishing	q.kit	q.pack	a	b	c	kg.x1	vol.x1
134003-039	● nero/black	x1	20	180	66	15x15	0,35	mc. 0,0006

05 bean-tavoletta in termoplastico spessore 16 mm
bean-writing tablet in plastic thickness 16 mm

code	finishing	q.kit	q.pack	a	b	kg.x1	vol.x1
134003-044	● nero/black	x1	20	235	370	0,40	mc. 0,002



vicenza-carrello portasedie con accessori nero
vicenza-trolley for chairs with accessories black

code	finishing
110803-365	● nero/black



for all colour codes, see page 361

TLT tablet TLT2 tablet TLT3 tablet BEAN tablet TL02 tablet SPT2 mechanism tablet SPTA mechanism antipanic



for writing tablet options, see page 404/405

vicenza

frame options



06

07

08

09



06



07



08

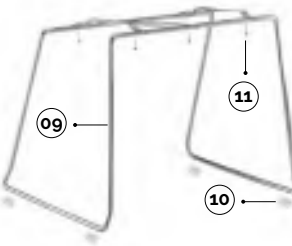

09

11

10

06 vicenza-sgabello per scocca con braccioni in tubo ø18 tappi sottopiede montati
vicenza-stool with arms for shell pipe ø18 inner feet caps assembled

code	finishing	q.kit	q.pack	a	b	c	d	e	kg.x1	vol.x1
111903-003	● nero/black	x1	80	255	315	486	500	630	2,50	mc. 0.040
111910-010	● cromato/chrome	x1	80	255	315	486	500	630	2,50	mc. 0.040

07 vicenza-sgabello per scocca con aggancio in tubo tappi sottopiede montati
vicenza-stool with hook for shell pipe inner feet caps assembled

code	finishing	diameter	q.kit	q.pack	a	b	c	d	e	f	kg.x1	vol.x1
111903-001	● nero/black	18	x1	200	255	315	500	480	460	438	1,90	mc. 0.020
111910-002	● cromato/chrome	18	x1	200	255	315	500	480	460	438	1,90	mc. 0.020
111903-249	● nero/black	20	x1	200	255	315	505	484	460	438	2,05	mc. 0.020
111910-249	● cromato/chrome	20	x1	200	255	315	505	484	460	438	2,05	mc. 0.020
111903-253	● nero/black	22	x1	180	255	315	510	484	460	438	2,30	mc. 0.020
111910-253	● cromato/chrome	22	x1	180	255	315	510	484	460	438	2,30	mc. 0.020

08 vicenza-sgabello per scocca in tubo tappi sottopiede montati
vicenza-stool for shell pipe inner feet caps assembled

code	finishing	diameter	q.kit	q.pack	a	b	c	d	e	f	kg.x1	vol.x1
111903-002	● nero/black	18	x1	200	255	315	500	478	460	438	1,85	mc. 0.020
111910-001	● cromato/chrome	18	x1	200	255	315	500	478	460	438	1,85	mc. 0.020
111903-248	● nero/black	20	x1	200	255	315	505	484	460	438	2,00	mc. 0.020
111910-248	● cromato/chrome	20	x1	200	255	315	505	484	460	438	2,00	mc. 0.020
111903-252	● nero/black	22	x1	180	255	315	510	484	460	438	2,25	mc. 0.020
111910-252	● cromato/chrome	22	x1	180	255	315	510	484	460	438	2,25	mc. 0.020

09 filo-telaio in tondino d.11
filo-slide wire frame d.11

code	finishing	q.kit	q.pack	a	b	c	kg.x1	vol.x1
113410-010	● cromato/chrome	x1	100	470	540	480	3,10	mc. 0.04

10 confezione di basi a pinza antirotazione per tondino colore neutro
neutral clips base for wire d.11 package

code	finishing	q.kit	q.pack
137006-070	○ neutro/neutral	x4	200

11 vite autoflettante truciolare tc* ø 5,5x19 per fissaggio sedile
screw chipboard tc* ø 5,5x19 for fixing seat

code	finishing	q.kit
117811-180	○ zincata/zinc	x4

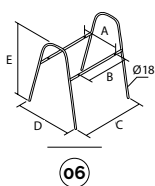

06

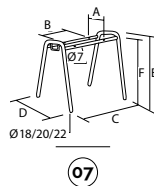

07

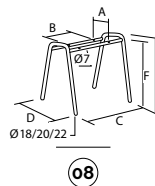

08

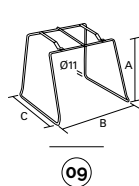

09

optionals

vicenza

swivel



plastic colours

- rosso/red ral 3002
- nero/black
- blu/blue ral 5002

main component sizes

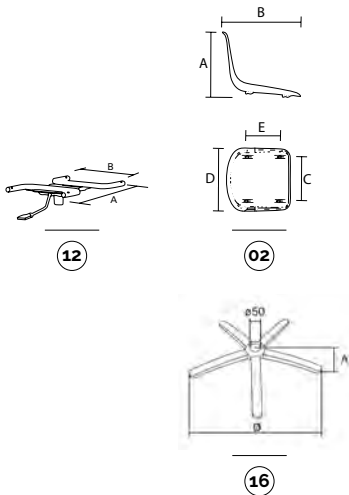

optionals

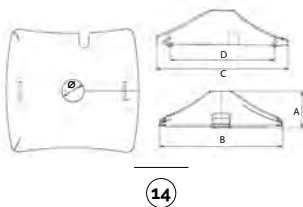

12 02 03 13 14 16
optional

12 vicenza gnr-supperto girevole a gas senza accessori
vicenza gnr-swivel metal frame for gas lift without accessories

code	finishing	q.kit	q.pack	a	b	kg.x1	vol.x1
110903-006	● nero/black	x1	10	315	255	1.40	mc. 0.004

02 vicenza-scocca intera
vicenza-plastic shell

code	finishing	q.kit	q.pack	a	b	c	d	e	kg.x1	vol.x1
133902-002	● rosso/red ral 3002	x2	12	395	470	315	430	255	1.30	mc. 0.014

03 confezione viti hilo d.5x35 testa svasata a croce zincate (vite fissaggio scocca)
screws auto-thread 5x35 flared cross head zinc for shell fixing package

code	finishing	q.kit	q.pack
117011-070	● zincata/zinc	x4	200

13 confezione tappi copritesta d.18 neri
black cover head caps d.18 package

code	finishing	q.kit	q.pack
137003-070	● nero/black	x4	200

14 cpg-copertina in plastica per telaio girevole
cpg-plastic cover for swivel frame

code	finishing	q.kit	q.pack	a	b	c	d	ø	kg.x1	vol.x1
130903-000	● nero/black	x1	50	60	200	210	167	36	0.1	mc. 0.0015

16 b40 base in metallo d.640 con coprisaldatura
b40 metal base d.640 with cover welding

code	finishing	q.kit	q.pack	a	ø	kg.x1	vol.x1
110210-027	● cromato/chrome	x1	5	60	640	2.85	mc. 0.014

CPG
plastic cover for swivel frame



for all colour codes, see page 361

vicenza

bench



plastic colours

- rosso/red ral 3002
- nero/black
- blu/blue ral 5002

15 02 03 13

main component sizes

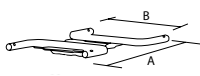

15

15 supporto per attacco scocca vicenza su panca
bench frame for pull shell

code	finishing	q.kit	q.pack	a	b	kg.x1	vol.x1
110703-016	● nero/black	x1	10	315	255	1.40	mc. 0.004

for the components below, see previous pages

02 03 13



for all colour codes, see below

for the bench components, see page 417

optionals

OPTIONAL
bench
connector



E-USB
bench plug



JIM
bench leg



plastic

90GM
bench leg



90GF
bench leg



91GM **NEW**
bench leg



100GM
bench leg



200GM
bench leg



PIONEER
bench arm



CUT
bench leg



SLIM
bench leg



CUT
bench arm



SLIM
bench arm



metal

aluminium

vicenza

optional colour codes

shell colour codes



02 scocche in plastica
plastic shells

- 133902-002 rosso/red ral 3002
- 133903-001 nero/black
- 133915-005 blu/blue ral 5002





90



discover more about
go Collection

La serie go è caratterizzata da un design classico e dalla riconosciuta qualità Alba.

Un ampio assortimento di telai e componenti completano l'offerta di un prodotto essenziale e versatile, capace di soddisfare ogni esigenza negli ambiti più diversi, rendendola una sedia dai grandi numeri.

Serie go is characterized by a classic design and famed Alba quality.

A wide assortment of frames and components complete the options available for this essential and versatile product. It caters for a broad range of needs in the most diverse settings, making it a very popular chair.

Plus

- Certificazione UNI 10977:2002 Livello 4.
- *UNI 10977:2002 Level 4 Certification.*



**certified
product**

90

4-legs

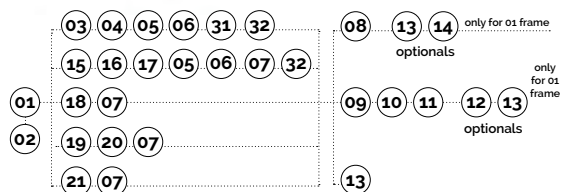

main component sizes

optionals

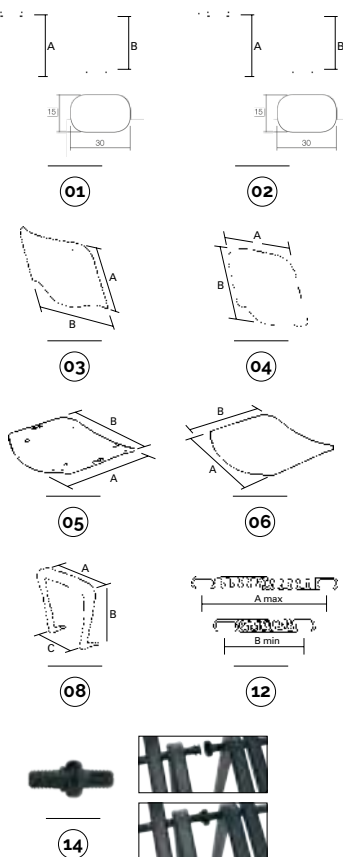

aggancio laterale maschio+femmina
in plastica con 2 viti
plastic lateral hook male+female
with 2 screws
134003-132

01 g2-telaio per sedia in tubo ovale 30x15 con tappi laterali e sottopiede montati

g2-chair frame in 30x15 oval tube with side and foot caps mounted

code	finishing	arm attach	q.kit	q.pack	a	b	kg.x1	vol.x1
112003-005	● nero/black	12	x1	160	450	425	3,00	mc. 0.021
112003-004	● nero/black	14	x1	160	450	425	3,00	mc. 0.021
112004-000	● grigio/grey	12	x1	160	450	425	3,00	mc. 0.021
112004-002	● grigio/grey	14	x1	160	450	425	3,00	mc. 0.021
112010-008	● cromato/chrome	12	x1	160	450	425	3,00	mc. 0.021
112010-005	● cromato/chrome	14	x1	160	450	425	3,00	mc. 0.021

02 g2-telaio per sedia in tubo ovale 30x15 con aggancio laterale in metallo saldato, con tappi laterali e sottopiede montati

g2-chair frame in 30x15 oval tube with metal lateral hook welded, side and foot caps mounted

code	finishing	arm attach	q.kit	q.pack	a	b	kg.x1	vol.x1
112003-016	● nero/black	12	x1	160	450	425	3,00	mc. 0.021
112003-015	● nero/black	14	x1	160	450	425	3,00	mc. 0.021
112004-007	● grigio/grey	12	x1	160	450	425	3,00	mc. 0.021
112004-008	● grigio/grey	14	x1	160	450	425	3,00	mc. 0.021
112010-016	● cromato/chrome	12	x1	160	450	425	3,00	mc. 0.021
112010-015	● cromato/chrome	14	x1	160	450	425	3,00	mc. 0.021

03 goshi-schienale interno in plastica

goshi-inner plastic back

code	finishing	q.kit	q.pack	a	b	kg.x1	vol.x1
132103-002	● nero/black	x1	40	330	470	0,60	mc. 0.004

04 goshe-coprischiena esterno in plastica

goshe-outer plastic back

code	finishing	q.kit	q.pack	a	b	kg.x1	vol.x1
132103-001	● nero/black	x1	30	475	335	0,40	mc. 0.004

05 gosdi-sedile interno in plastica

gosdi-inner plastic seat

code	finishing	q.kit	q.pack	a	b	kg.x1	vol.x1
132203-002	● nero/black	x1	30	460	400	0,80	mc. 0.004

06 gosde-sottosedile esterno plastica

gosde-outer plastic seat

code	finishing	q.kit	q.pack	a	b	kg.x1	vol.x1
132203-001	● nero/black	x1	80	410	465	0,40	mc. 0.003

31 vite tsp+ m6x20 zincata bianca

screw tsp+ m6x20 white zinc

code	finishing	q.kit
117711-203	● zincata bianca/white zinc	x2

32 vite tsp+ m6x25 zincata bianca

screw tsp+ m6x25 white zinc

code	finishing	q.kit
117711-199	● zincata bianca/white zinc	x2

08 gob-bracciolo in nylon

gob-nylon armrest

code	finishing	arm attach	q.kit	q.pack	a	b	c	kg.x1	vol.x1
131703-002	● nero/black	14	x2	20	290	250	190	0,80	mc. 0.0026
131703-004	● nero/black	12	x2	20	290	250	190	0,80	mc. 0.0026

12 coppia pinze regolabili per tubo ovale 15x30 pp

clips for oval tube 15x30 pp

code	finishing	q.kit	q.pack	a	b
134003-002	● nero/black	x1	200	214	134

13 g2c-cestello portariviste

g2c-magazine rack

code	finishing	q.kit	q.pack	kg.x1	vol.x1
113403-001	● nero/black	x1	25	0,975	mc. 0.03
113410-020	● cromato/chrome	x1	25	0,975	mc. 0.03

90

4-legs/tablet accessories

main component sizes



09

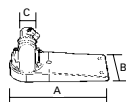

10

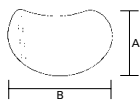

11

09 g0bp-bracciolo in nylon con aggancio porta tavoletta
g0bp-nylon armrest with writing tablet hook

code	finishing	arm attach	q.kit	q.pack	a	b	c	d	kg.x1	vol.x1
131703-001	● nero/black	14	x1	20	290	250	190	15x15	0,80	mc. 0,0026
131703-003	● nero/black	12	x1	20	290	250	190	15x15	0,80	mc. 0,0026

10 sp2z-snodo per tavoletta in termoplastica
sp2z-thermoplastic writing tablet articulation

code	finishing	q.kit	q.pack	a	b	c	kg.x1	vol.x1
134003-039	● nero/black	x1	20	180	66	15x15	0,35	mc. 0,0006

11 bean-tavoletta in termoplastico spessore 16 mm
bean-16mm thick thermoplastic writing tablet

code	finishing	q.kit	q.pack	a	b	kg.x1	vol.x1
134003-044	● nero/black	x1	20	235	370	0,40	mc. 0,002

TLT tablet TLT2 tablet TLT3 tablet BEAN tablet TLo2 tablet SPT2 mechanism tablet SPTA mechanism antipanic



for writing tablet options, see page 404/405

4-legs/backrest and seat options

main component sizes

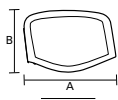

15

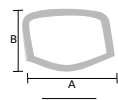

16

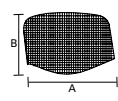

17



15 isonet-telaio schienale in plastica con viti per rete
isonet-outer frame with screws for net

code	finishing	q.kit	q.pack	a	b	kg.x1	vol.x1
132103-003	● nero/black	x1	25	470	345	0,42	mc. 0,006

16 isonet-cornice schienale in plastica per rete
isonet-open frame for isonet model

code	finishing	q.kit	q.pack	a	b	kg.x1	vol.x1
132103-004	● nero/black	x1	25	470	345	0,31	mc. 0,004

17 isonet-rete per schienale
isonet-net for back

code	finishing	q.kit	q.pack	a	b	kg.x1	vol.x1
132105-500	○ bianco/white	x1	25	550	400	0,14	mc. 0,0057
132103-500	● nero/black	x1	25	550	400	0,14	mc. 0,0057
132102-500	● rosso/red	x1	25	550	400	0,14	mc. 0,0057

07 vite testa svasata croce m6x18 brunita nera-fissaggio sedile/ schienale faggio
m6x18 black burnished flared philips screw-beech seat/backrest fixing

code	finishing	q.kit
117703-195	● nero/black	x4

and · 05 06 32

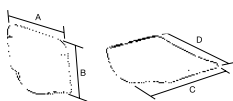

18



18 novx-sedile e schienale in plastica disponibili per telaio in tubo ovale e in tubo ellittico
novx-plastic seat and backrest available for oval or elliptic tube frame

code	finishing	q.kit	q.pack	a	b	c	d	kg.x1	vol.x1
134002-001	● rosso/red	x1	20	470	315	460	400	1,21	mc. 0,008
134003-119	● nero/black	x1	20	470	315	460	400	1,21	mc. 0,008
134015-003	● blu/blue	x1	20	470	315	460	400	1,21	mc. 0,008

and · 07

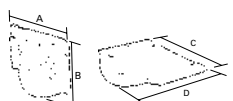

19



19 prisma-schienale e sedile in plastica disponibili per telaio in tubo ovale e in tubo ellittico
prisma-plastic backrest and seat available for oval or elliptic tube frame

code	finishing	q.kit	q.pack	a	b	c	d	kg.x1	vol.x1
134003-110	● nero/black	x1	10	470	330	460	430	1,60	mc. 0,016

20 prisma-pannello sedile da tappezzare
prisma-seat panel to upholster

code	finishing	q.kit	q.pack	a	b	kg.x1	vol.x1
132203-010	● nero/black	x1	20	400	400	0,40	mc. 0,004

and · 07



21



21 goshsdlf-schienale + sedile multistrato verniciato faggio + 4 testine
goshsdlf-backrest + seat in painted planed beech plywood

code	finishing	q.kit	q.pack	a	b	c	d	e	f	kg.x1	vol.x1
124007-000	● faggio/beech-wood	x1	10	325	465	415	460	10	10	2,70	mc. 0,07

and · 07

90

4-legs w/armrests

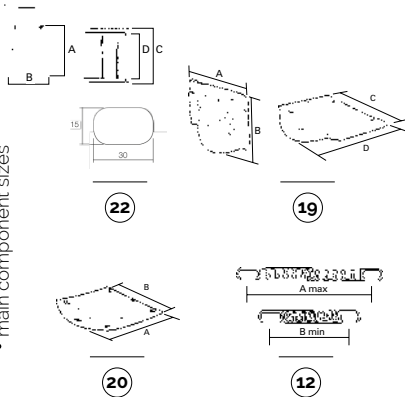
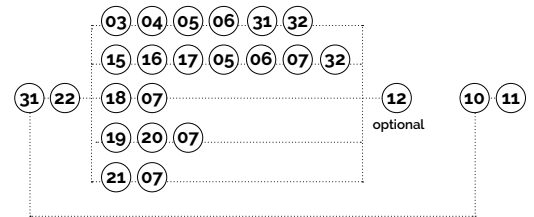

main component sizes

22 g4-telaio per sedia in tubo ovale 30x15 con braccioli con tappi laterali e sottopiede montati
g4-chair frame in 30x15 oval tube with armrests, side and foot caps mounted

code	finishing	q.kit	q.pack	a	b	c	d	kg.x1	vol.x1
112003-020	● nero/black	x1	68	450	470	545	425	3,80	mc. 0,042
112004-021	● grigio/grey	x1	68	450	470	545	425	3,80	mc. 0,042
112010-040	● cromato/chrome	x1	68	450	470	545	425	3,80	mc. 0,042

19 prisma-schienale e sedile in plastica disponibili per telaio in tubo ovale e in tubo ellittico
prisma-plastic backrest and seat available for oval or elliptic tube frame

code	finishing	q.kit	q.pack	a	b	c	d	kg.x1	vol.x1
134003-110	● nero/black	x1	10	470	330	460	430	1,60	mc. 0,016

20 prisma-pannello sedile da tappezzare
prisma-seat panel to upholster

code	finishing	q.kit	q.pack	a	b	kg.x1	vol.x1
132203-010	● nero/black	x1	20	400	400	0,40	mc. 0,004

07 vite testa svasata croce m6x18 brunita nera-fissaggio sedile/ schienale faggio
m6x18 black burnished flared philips screw-beech seat/backrest fixing

code	finishing	q.kit
117703-195	● nero/black	x4

12 coppia pinze regolabili per tubo ovale 15x30 pp
clips for oval tube 15x30 pp

code	finishing	q.kit	q.pack	a	b
134003-002	● nero/black	x1	200	214	134

90

4-legs with armrests/tablet accessories

main component sizes

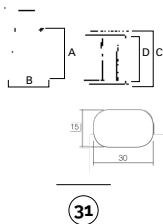

aggancio tavoletta
tablet hook

31

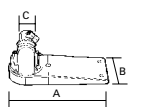

10

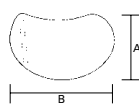

11

31 94-telaio per sedia in tubo ovale 30x15 con braccioli per tavoletta
94-chair frame in 30x15 oval tube with armrests for writing tablet

code	finishing	q.kit	q.pack	a	b	c	d	kg.x1	vol.x1
112003-022	● nero/black	x1	80	450	470	545	425	3,80	mc. 0.042
112004-022	● grigio/grey	x1	80	450	470	545	425	3,80	mc. 0.042
112010-043	● cromato/chrome	x1	80	450	470	545	425	3,80	mc. 0.042

10 spt2-snodo per tavoletta in termoplastica
spt2-thermoplastic writing tablet articulation

code	finishing	q.kit	q.pack	a	b	c	kg.x1	vol.x1
134003-039	● nero/black	x1	20	180	66	15x15	0,35	mc. 0.0006

11 bean-tavoletta in termoplastico spessore 16 mm
bean-16mm thick thermoplastic writing tablet

code	finishing	q.kit	q.pack	a	b	kg.x1	vol.x1
134003-044	● nero/black	x1	20	235	370	0,40	mc. 0.002

TLT tablet TLT2 tablet TLT3 tablet BEAN tablet TL02 tablet SPT2 mechanism tablet SPTA mechanism antipanic



for writing tablet options, see page 404/405

4-legs with armrests/backrest and seat options

main component sizes

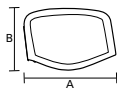

15

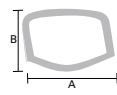

16

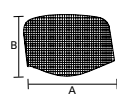

17



15 isonet-telaio schienale in plastica con viti per rete
isonet-outer frame with screws for net

code	finishing	q.kit	q.pack	a	b	kg.x1	vol.x1
132103-003	● nero/black	x1	25	470	345	0,42	mc. 0.006

16 isonet-cornice schienale in plastica per rete
isonet-open frame for isonet model

code	finishing	q.kit	q.pack	a	b	kg.x1	vol.x1
132103-004	● nero/black	x1	25	470	345	0,31	mc. 0.004

17 isonet-rete per schienale
isonet-net for back

code	finishing	q.kit	q.pack	a	b	kg.x1	vol.x1
132105-500	○ bianco/white	x1	25	550	400	0,14	mc. 0.0057
132103-500	● nero/black	x1	25	550	400	0,14	mc. 0.0057
132102-500	● rosso/red	x1	25	550	400	0,14	mc. 0.0057

and .. **05** **06** **07** **32**

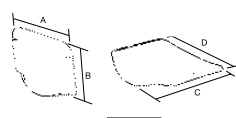

18



18 novx-sedile e schienale in plastica disponibili per telaio in tubo ovale e in tubo ellittico
novx-plastic seat and backrest available for oval or elliptic tube frame

code	finishing	q.kit	q.pack	a	b	c	d	kg.x1	vol.x1
134002-001	● rosso/red ral3002	x1	20	470	315	460	400	1,21	mc. 0.008
134003-119	● nero/black ral9005	x1	20	470	315	460	400	1,21	mc. 0.008
134015-003	● blu/blue ral5002	x1	20	470	315	460	400	1,21	mc. 0.008

and .. **07**

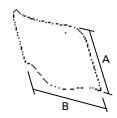

03



03 goshi-schienale interno in plastica
goshi-inner plastic back

code	finishing	q.kit	q.pack	a	b	kg.x1	vol.x1
132103-002	● nero/black	x1	40	330	470	0,60	mc. 0.004

04 goshe-coprischienale esterno in plastica
goshe-outer plastic back

code	finishing	q.kit	q.pack	a	b	kg.x1	vol.x1
132103-001	● nero/black	x1	30	475	335	0,40	mc. 0.004

and .. **05** **06** **31** **32**

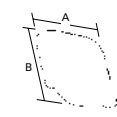

04

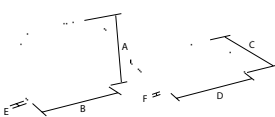

21



21 goshsdlf-schienale + sedile multistrato verniciato faggio + 4 testine
goshsdlf-backrest + seat in painted planed beech plywood

code	finishing	q.kit	q.pack	a	b	c	d	e	f	kg.x1	vol.x1
124007-000	● faggio/beech-wood	x1	10	325	465	415	460	10	10	2,70	mc. 0.07

and .. **07**

90 slide

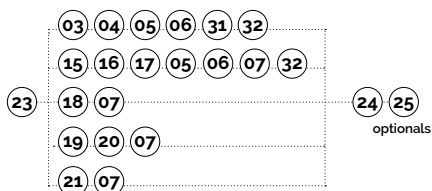
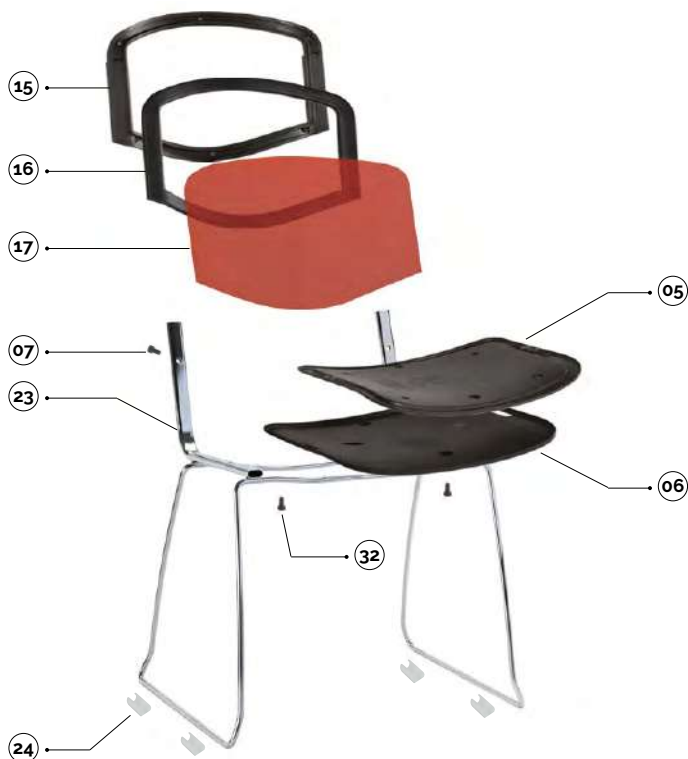

main component sizes

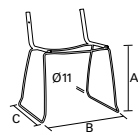

23

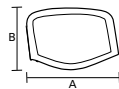

15

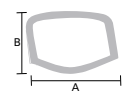

16

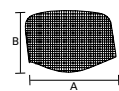

17

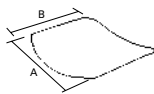

05

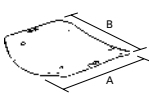

06



24



25

optionals

23 spritz-telaio chiuso in tondino d.11 tappi esclusi
spritz-sled wire frame d.11 caps excluded

code	finishing	q.kit	q.pack	a	b	c	kg.x1	vol.x1
112010-250	● cromato/chrome	x1	100	450	580	470	4,00	mc. 0,042

24 confezione di basi a pinza antirotazione per tondino colore neutro
neutral clips base for wire d.11 package

code	finishing	q.kit	q.pack
137006-070	○ neutro/neutral	x4	200

25 base piana a pinza doppia
double flat clip base

code	finishing	q.kit
134006-021	○ neutro/neutral	x4

15 isonet-telaio schienale in plastica con viti per rete
isonet-outer frame with screws for net

code	finishing	q.kit	q.pack	a	b	kg.x1	vol.x1
132103-003	● nero/black	x1	25	470	345	0,42	mc. 0,006

16 isonet-cornice schienale in plastica per rete
isonet-open frame for isonet model

code	finishing	q.kit	q.pack	a	b	kg.x1	vol.x1
132103-004	● nero/black	x1	25	470	345	0,31	mc. 0,004

17 isonet-rete per schienale
isonet-net for back

code	finishing	q.kit	q.pack	a	b	kg.x1	vol.x1
132105-500	○ bianco/white	x1	25	550	400	0,14	mc. 0,0057
132103-500	● nero/black	x1	25	550	400	0,14	mc. 0,0057
132102-500	● rosso/red	x1	25	550	400	0,14	mc. 0,0057

05 gosdi-sedile interno in plastica
gosdi-inner plastic seat

code	finishing	q.kit	q.pack	a	b	kg.x1	vol.x1
132203-002	● nero/black	x1	30	460	400	0,80	mc. 0,004

06 gosde-sottosedile esterno plastica
gosde-outer plastic seat

code	finishing	q.kit	q.pack	a	b	kg.x1	vol.x1
132203-001	● nero/black	x1	80	410	465	0,40	mc. 0,003

07 vite testa svasata croce m6x18 brunita nera-fissaggio sedile/ schienale faggio
m6x18 black burnished flared philips screw-beech seat/backrest fixing

code	finishing	q.kit
117703-195	● nero/black	x4

32 vite tsp+ m6x25 zincata bianca
screw tsp+ m6x25 white zinc

code	finishing	q.kit
117711-199	● zincata bianca/white zinc	x2

90

slide/backrest and seat options

main component sizes

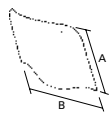

03

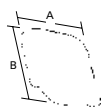

04



03 goshi-schienale interno in plastica
goshi-inner plastic back

code	finishing	q.kit	q.pack	a	b	kg.x1	vol.x1
132103-002	● nero/black	x1	40	330	470	0.60	mc. 0.004

04 goshe-coprischienale esterno in plastica
goshe-outer plastic back

code	finishing	q.kit	q.pack	a	b	kg.x1	vol.x1
132103-001	● nero/black	x1	30	475	335	0.40	mc. 0.004

and · **05** **06** **31** **32**

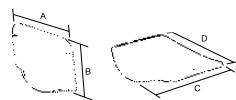

18



18 novx-sedile e schienale in plastica disponibili per telaio in tubo ovale e in tubo ellittico
novx-plastic seat and backrest available for oval or elliptic tube frame

code	finishing	q.kit	q.pack	a	b	c	d	kg.x1	vol.x1
134002-001	● rosso/red	x1	20	470	315	460	400	1.21	mc. 0.008
134003-119	● nero/black	x1	20	470	315	460	400	1.21	mc. 0.008
134015-003	● blu/blue	x1	20	470	315	460	400	1.21	mc. 0.008

and · **07**



19



19 prisma-schienale e sedile in plastica disponibili per telaio in tubo ovale e in tubo ellittico
prisma-plastic backrest and seat available for oval or elliptic tube frame

code	finishing	q.kit	q.pack	a	b	c	d	kg.x1	vol.x1
134003-110	● nero/black	x1	10	470	330	460	430	1.60	mc. 0.016

20 prisma-pannello sedile da tappezzare
prisma-seat panel to upholster

code	finishing	q.kit	q.pack	a	b	kg.x1	vol.x1
132203-010	● nero/black	x1	20	400	400	0.40	mc. 0.004

and · **07**

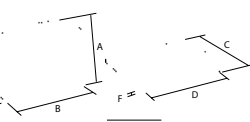

21



21 goshsdlf-schienale + sedile multistrato verniciato faggio + 4 testine
goshsdlf-backrest + seat in painted planed beech plywood

code	finishing	q.kit	q.pack	a	b	c	d	e	f	kg.x1	vol.x1
124007-000	● faggio/beech-wood	x1	10	325	465	415	460	10	10	2.70	mc. 0.07

and · **07**

90 swivel

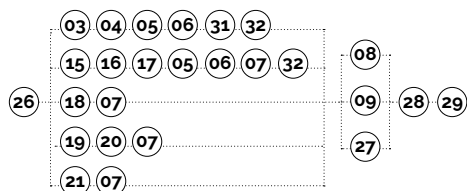

main component sizes

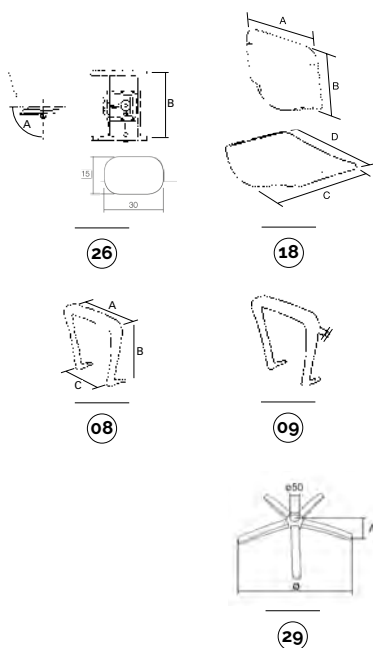

26 g2gv-telaio per sedia girevole in tubo ovale 30x15 con piastra comando a gas compresso di spatola, tappi esclusi
g2gv-swivel chair frame in 30x15 oval tube with gas control plate incl. spatula, excluding caps

code	finishing	arm attach	q.kit	q.pack	a	b	kg.x1	vol.x1
112003-200	● nero/black	14	x1	200	87"	425	2.62	mc. 0.015
112003-201	● nero/black	12	x1	200	87"	425	2.62	mc. 0.015
112010-200	● cromato/chrome	14	x1	200	87"	425	2.62	mc. 0.015
112010-201	● cromato/chrome	12	x1	200	87"	425	2.62	mc. 0.015

18 novx-sedile e schienale in plastica disponibili per telaio in tubo ovale e in tubo ellittico
novx-plastic seat and backrest available for oval or elliptic tube frame

code	finishing	arm attach	q.kit	q.pack	a	b	c	d	kg.x1	vol.x1
134002-001	● rosso/red	ral3002	x1	20	470	315	460	400	1.21	mc. 0.008
134003-119	● nero/black	ral9005	x1	20	470	315	460	400	1.21	mc. 0.008
134015-003	● blu/blue	ral5002	x1	20	470	315	460	400	1.21	mc. 0.008

08 gob-bracciolo in nylon
gob-nylon armrest

code	finishing	arm attach	q.kit	q.pack	a	b	c	kg.x1	vol.x1
131703-002	● nero/black	14	x2	20	290	250	190	0.80	mc. 0.0026
131703-004	● nero/black	12	x2	20	290	250	190	0.80	mc. 0.0026

09 gobp-bracciolo in nylon con aggancio porta tavoletta
gobp-nylon armrest with writing tablet hook

code	finishing	arm attach	q.kit	q.pack	a	b	c	d	kg.x1	vol.x1
131703-001	● nero/black	14	x1	20	290	250	190	15x15	0.80	mc. 0.0026
131703-003	● nero/black	12	x1	20	290	250	190	15x15	0.80	mc. 0.0026

07 vite testa svasata croce m6x18 brunita nera-fissaggio sedile/ schienale faggio
m6x18 black burnished flared philips screw-beech seat/backrest fixing

code	finishing	q.kit
117703-195	● nero/black	x4

27 confezione tappi copritesta d.18 neri
black cover head caps d.18 package

code	finishing	diameter	q.kit	q.pack
137003-070	● nero/black	ø18	x4	200
134103-151	● nero/black	ø15	x4	

28 confezione tappi copritesta ovali 30x15 neri
black oval cover head caps 30x15 package

code	finishing	q.kit	q.pack
137003-071	● nero/black	x4	200

29 b40 base in metallo d.640 con coprisaldatura
b40 metal base d.640 with cover welding

code	finishing	q.kit	q.pack	a	ø	kg.x1	vol.x1
110210-027	● cromato/chrome	x1	5	60	640	2.85	mc. 0.014

90

swivel/backrest and seat options

main component sizes

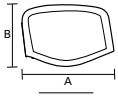

15

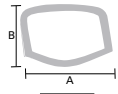

16

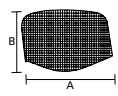

17



- 15** isonet-telaio schienale in plastica con viti per rete
isonet-outer frame with screws for net

code	finishing	q.kit	q.pack	a	b	kg.x1	vol.x1
132103-003	● nero/black	x1	25	470	345	0,42	mc. 0,006

- 16** isonet-cornice schienale in plastica per rete
isonet-open frame for isonet model

code	finishing	q.kit	q.pack	a	b	kg.x1	vol.x1
132103-004	● nero/black	x1	25	470	345	0,31	mc. 0,004

- 17** isonet-rete per schienale
isonet-net for back

code	finishing	q.kit	q.pack	a	b	kg.x1	vol.x1
132105-500	○ bianco/white	x1	25	550	400	0,14	mc. 0,0057
132103-500	● nero/black	x1	25	550	400	0,14	mc. 0,0057
132102-500	● rosso/red	x1	25	550	400	0,14	mc. 0,0057

and · (05) (06) (07) (32)



03

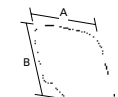

04



- 03** goshi-schienale interno in plastica
goshi-inner plastic back

code	finishing	q.kit	q.pack	a	b	kg.x1	vol.x1
132103-002	● nero/black	x1	40	330	470	0,60	mc. 0,004

- 04** goshe-coprischienale esterno in plastica
goshe-outer plastic back

code	finishing	q.kit	q.pack	a	b	kg.x1	vol.x1
132103-001	● nero/black	x1	30	475	335	0,40	mc. 0,004

and · (05) (06) (31) (32)

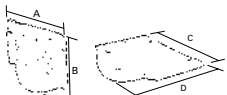

19

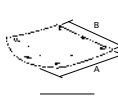

20



- 19** prisma-schienale e sedile in plastica disponibili per telaio in tubo ovale e in tubo ellittico
prisma-plastic backrest and seat available for oval or elliptic tube frame

code	finishing	q.kit	q.pack	a	b	c	d	kg.x1	vol.x1
134003-110	● nero/black	x1	10	470	330	460	430	1,60	mc. 0,016

- 20** prisma-pannello sedile da tappezzare
prisma-seat panel to upholster

code	finishing	q.kit	q.pack	a	b	kg.x1	vol.x1
132203-010	● nero/black	x1	20	400	400	0,40	mc. 0,004

and · (07)

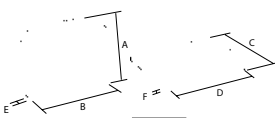

21



- 21** goshsdlf-schienale + sedile multistrato verniciato faggio + 4 testine
goshsdlf-backrest + seat in painted planed beech plywood

code	finishing	q.kit	q.pack	a	b	c	d	e	f	kg.x1	vol.x1
124007-000	● faggio/beech-wood	x1	10	325	465	415	460	10	10	2,70	mc. 0,07

and · (07)

90 bench



CERTIFIED BY
CATAS

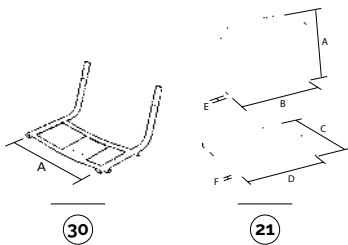
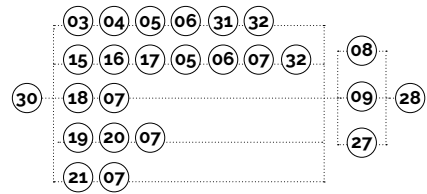

30 g2pv-telaio in tubo ovale o ellittico per panca verniciata g2pv-oval or elliptic tube frame for painted bench

code	finishing	arm attach	q.kit	q.pack	a	kg.x1	vol.x1
110703-061	● nero/black	12 ovale/oval	x1	200	425	2,20	mc. 0.015
110703-062	● nero/black	14 ovale/oval	x1	200	425	2,20	mc. 0.015

21 g0shsdlf-schienale + sedile multistrato verniciato faggio + 4 testine g0shsdlf-backrest + seat in painted planed beech plywood

code	finishing	q.kit	q.pack	a	b	c	d	e	f	kg.x1	vol.x1
124007-000	● faggio/beech-wood	x1	10	325	465	415	460	10	10	2,70	mc. 0.07

07 vite testa svasata croce m6x18 brunita nera-fissaggio sedile/ schienale faggio m6x18 black burnished flared philips screw-beech seat/backrest fixing

code	finishing	q.kit
117703-195	● nero/black	x4

27 confezione tappi copritesta d.18 neri black cover head caps d.18 package

code	finishing	diameter	q.kit	q.pack
137003-070	● nero/black	ø18	x4	200
134103-151	● nero/black	ø15	x4	

28 confezione tappi copritesta ovali 30x15 neri black oval cover head caps 30x15 package

code	finishing	q.kit	q.pack
137003-071	● nero/black	x4	200

for the bench components, see page 417

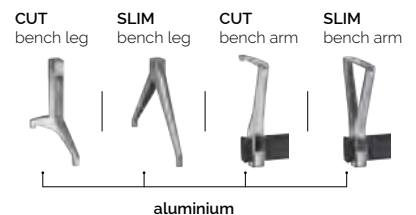
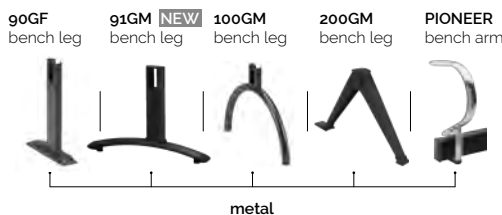

main component sizes

optionals





stelo



discover more about
Stelo Collection

La collezione di appendiabiti Stelo spicca per il curato design della testa girevole e un'estetica razionale ed essenziale.

Stelo è estremamente funzionale, grazie al semplice sistema di incastro dei vari elementi, è rapido da montare e smontare.

La struttura metallica è disponibile in 4 finiture, ed è abbinabile agli elementi in plastica offerti in 3 colori.

The Stelo coat hangers collection stands out for its neat swivel head design and essential overall aesthetics.

Stelo is extremely functional, thanks to the simple interlocking system of the various elements, and is quick to assemble and disassemble.

The metal frame is available in 4 finishes, and can be combined with the plastic elements offered in 3 colors.

Plus

- Sistema di assemblaggio ad incastro.
- Tubi in metallo da 40mm in 4 diversi colori.
- Parti in plastica disponibile in 3 diversi colori.
- Pratica testa girevole e comodo porta ombrelli.
- *Interlocking assembly system.*
- *40mm metal tubes in 4 different colors.*
- *Plastic parts available in 3 different colors.*
- *Practical swivel head and convenient umbrella holder.*



designed by:
Shannon Sadler

stelo

components

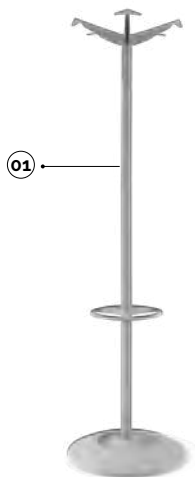
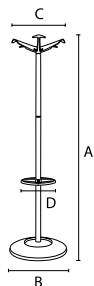

01 stelo-appendiabito a colonna con portaombrelli
stelo-coat hanger with umbrella stand

code	metal finishing	plastic finishing	q.kit	q.pack	a	ø b	ø c	ø d	kg.x1	vol.x1
110403-189	● nero/black	● nero/black	x1	48	1720	470	441	282	4,3	mc. 0.05
110404-189	● grigio/grey	● nero/black	x1	48	1720	470	441	282	4,3	mc. 0.05
110404-190	● grigio/grey	● grigio/grey	x1	48	1720	470	441	282	4,3	mc. 0.05
110405-189	○ bianco/white	● nero/black	x1	48	1720	470	441	282	4,3	mc. 0.05
110405-190	○ bianco/white	○ bianco/white	x1	48	1720	470	441	282	4,3	mc. 0.05
110410-189	● cromato/chrome	● nero/black	x1	48	1720	470	441	282	4,3	mc. 0.05
110410-190	● cromato/chrome	● grigio/grey	x1	48	1720	470	441	282	4,3	mc. 0.05

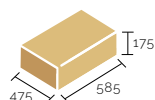

1 kit
per colour

choose the finish that best suits your environment





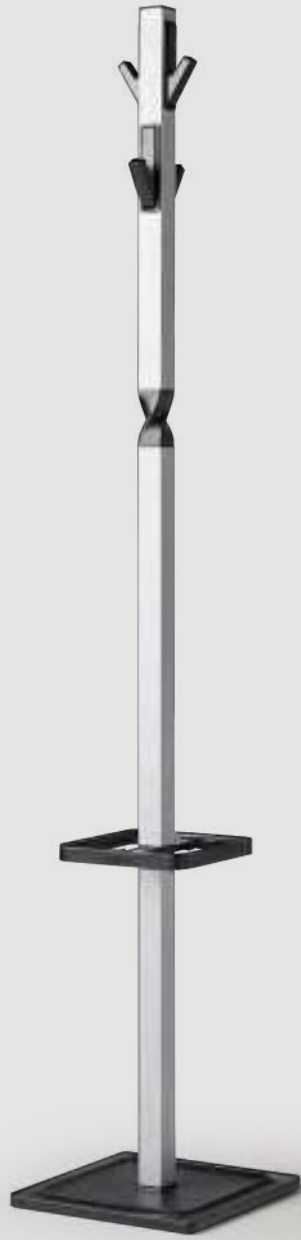

space



discover more about
Space Collection

Stile e funzionalità.

Space è il complemento d'arredo dal design minimal e ricercato. I suoi agganci a scomparsa abbinati alle possibili finiture della colonna in metallo a sezione quadrata, saranno la tendenza del futuro.

La sua perfetta stabilità, grazie alla base in metallo, e la comodità di utilizzo lo rendono un elemento d'arredo assolutamente indispensabile.

Space è ideale per gli ambienti Office, Contract e Home.

Style and functionality.

Space is the furnishing accessory with a minimalist, highly refined design.

Its foldaway hooks, teamed with the possible finishes for the square-section metal column, are sure to become the trend for the future. Perfect stability is assured thanks to the metal base, and its ease of use makes it an absolutely indispensable furnishing element.

Space is ideal for Office, Contract and Home environments.

Plus

- Agganci a scomparsa e design a sezione quadrata della colonna.
- Pratico portabombrelli.
- 3 colori disponibili.
- Dimensioni di imballo molto compatte.
- *Foldaway hooks and square-section design of the column.*
- *Practical umbrella holder.*
- *Available in 3 colours.*
- *Very compact packaging size.*



designed by:
Stefano Bettio

space

components

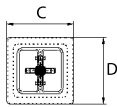
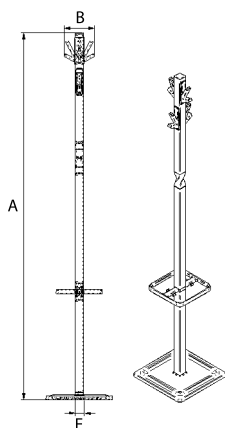

01

main component sizes

01 space-appendiabito a colonna in tubo quadro con portaombrelli componenti in plastica
space-coat hanger in square tube with umbrella stand and plastic components

code	finishing	plastic	q.kit	q.pack	a	b	c	d	e	kg.x1	vol.x1
110403-170	● nero/black	● nero/black	x1	60	1750	145	320	320	40x40	7,60	mc. 0.032
110404-170	● grigio/grey	● nero/black	x1	60	1750	145	320	320	40x40	7,60	mc. 0.032
110405-170	○ bianco/white	● nero/black	x1	60	1750	145	320	320	40x40	7,60	mc. 0.032

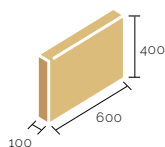





coat hangers



discover more about
Coat hangers Collection

L'estrema funzionalità unita a un design sempre distintivo consentono di rendere ogni proposta di appendiabiti Alba degna di nota.

L'elevata qualità dei materiali utilizzati e la ricerca attenta delle più idonee finiture e dei colori delle plastiche, abbinata al metallo, consentono di offrire non semplici complementi ma vere e proprie soluzioni d'arredo per i diversi ambienti.

Sovente arricchiti con accessori come il porta ombrelli e/o il vassoio porta oggetti, garantiscono massima funzionalità e praticità di utilizzo.

Unrivalled functionality and distinctive designs make every Alba coat stand exceptional.

The superior-quality materials used and extensive research into the most suitable finishes and colours of the plastics, combined with perfectly matched metals, enable us to offer not just complements but genuine furnishing solutions for different environments.

Often enhanced with accessories such as the umbrella holder and/or objects tray, they guarantee maximum functionality and ease of use.

coat hangers

components

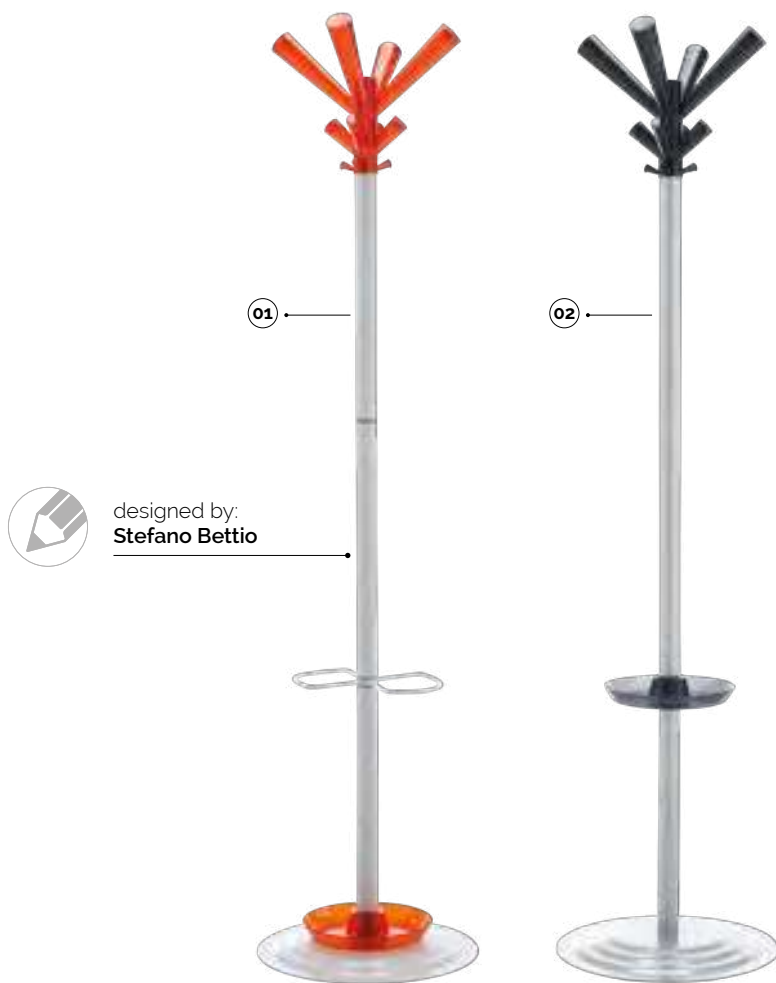

designed by:
Stefano Bettio

main component sizes

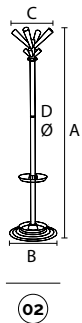
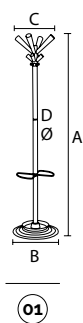

01 joy-appendiabito a colonna con portaombrelli componenti in plastica joy-coat hanger with umbrella stand plastic components

code	finishing	plastic	q.kit	q.pack	a	b	c	d	kg.x1	vol.x1
110404-100	● grigio/grey	○ transparent	x1	60	1750	415	380	40	8,65	mc. 0.039
110404-101	● grigio/grey	● orange transparent	x1	60	1750	415	380	40	8,65	mc. 0.039
110404-102	● grigio/grey	● fumé transparent	x1	60	1750	415	380	40	8,65	mc. 0.039
110405-100	○ bianco/white	○ transparent	x1	60	1750	415	380	40	8,65	mc. 0.039
110405-101	○ bianco/white	● orange transparent	x1	60	1750	415	380	40	8,65	mc. 0.039
110405-102	○ bianco/white	● fumé transparent	x1	60	1750	415	380	40	8,65	mc. 0.039

02 easy-appendiabito a colonna con vassoio portaoggetti componenti in plastica easy-coat hanger with multipurpose tray plastic components

code	finishing	plastic	q.kit	q.pack	a	b	c	d	kg.x1	vol.x1
110404-106	● grigio/grey	○ transparent	x1	60	1750	415	380	40	8,20	mc. 0.039
110404-107	● grigio/grey	● orange transparent	x1	60	1750	415	380	40	8,20	mc. 0.039
110404-108	● grigio/grey	● fumé transparent	x1	60	1750	415	380	40	8,20	mc. 0.039
110405-106	○ bianco/white	○ transparent	x1	60	1750	415	380	40	8,20	mc. 0.039
110405-107	○ bianco/white	● orange transparent	x1	60	1750	415	380	40	8,20	mc. 0.039
110405-108	○ bianco/white	● fumé transparent	x1	60	1750	415	380	40	8,20	mc. 0.039

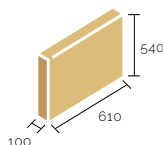
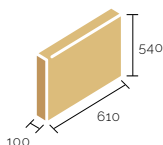

coat hangers

components

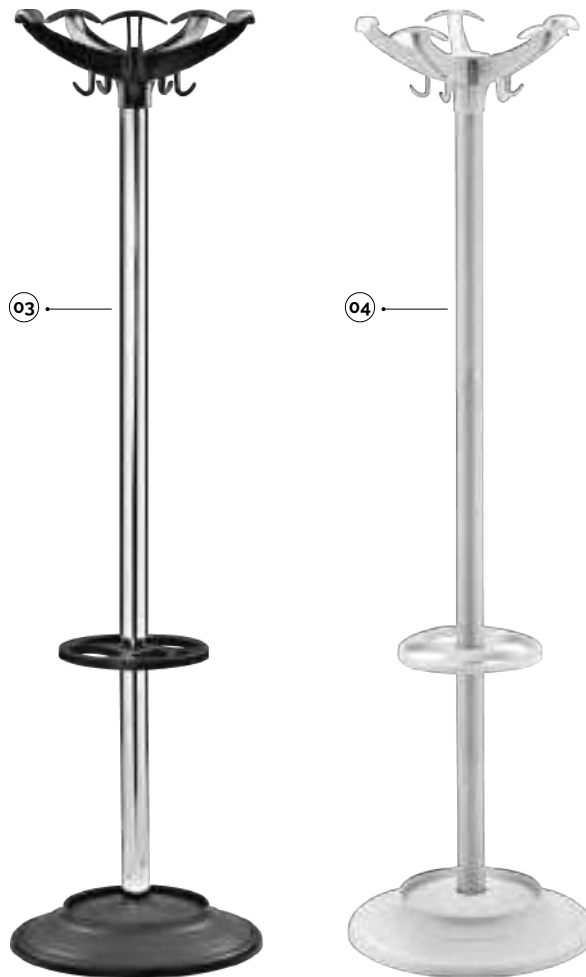

main component sizes

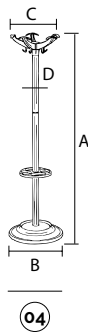
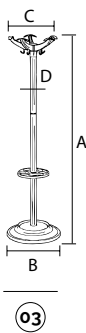

03 elix-appendiabito a colonna con portaombrelli, componenti in plastica neri
elix-coat hanger with umbrella stand, black plastic components

code	finishing	plastic	q.kit	q.pack	a	b	c	d	kg.x1	vol.x1
110403-040	● nero/black	● nero/black	x1	60	1730	450	400	50	5,00	mc. 0.045
110404-006	● grigio/grey	● nero/black	x1	60	1730	450	400	50	5,00	mc. 0.045
110405-015	○ bianco/white	● nero/black	x1	60	1730	450	400	50	5,00	mc. 0.045
110410-040	● cromato/chrome	● nero/black	x1	60	1730	450	400	50	5,00	mc. 0.045

04 elix-g-appendiabito a colonna con portaombrelli, componenti in plastica grigi
elix-g-coat hanger with umbrella stand, grey plastic components

code	finishing	plastic	q.kit	q.pack	a	b	c	d	kg.x1	vol.x1
110404-005	● grigio/grey	● grigio/grey	x1	60	1730	450	400	50	5,00	mc. 0.045
110410-039	● cromato/chrome	● grigio/grey	x1	60	1730	450	400	50	5,00	mc. 0.045

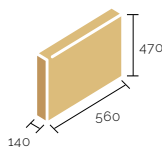
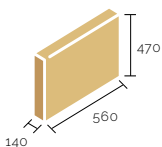

coat hangers

components



main component sizes

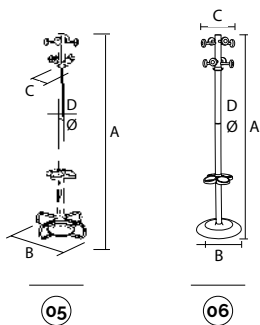

05 bravo-appendiabito a colonna con portaombrelli, componenti in plastica neri
bravo-coat hanger with umbrella stand, plastic components black

code	finishing	plastic	q.kit	q.pack	a	b	c	d	kg.x1	vol.x1
110403-001	● nero/black	● nero/black	x1	60	1750	415	380	50	8,20	mc. 0.039
110404-029	● grigio/grey	● nero/black	x1	60	1750	415	380	50	8,20	mc. 0.039
110410-029	● cromato/chrome	● nero/black	x1	60	1750	415	380	50	8,20	mc. 0.039

06 eco-appendiabito a colonna con portaombrelli componenti in plastica neri
eco-coat hanger with umbrella stand, plastic components black

code	finishing	plastic	q.kit	q.pack	a	b	c	d	kg.x1	vol.x1
110403-025	● nero/black	● nero/black	x1	50	1700	400	330	50	5,00	mc. 0.045
110404-120	● grigio/grey	● nero/black	x1	50	1700	400	330	50	5,00	mc. 0.045
110410-120	● cromato/chrome	● nero/black	x1	50	1700	400	330	50	5,00	mc. 0.045

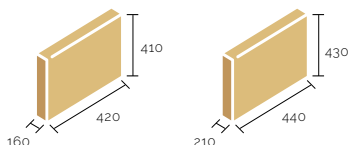

coat hangers

components

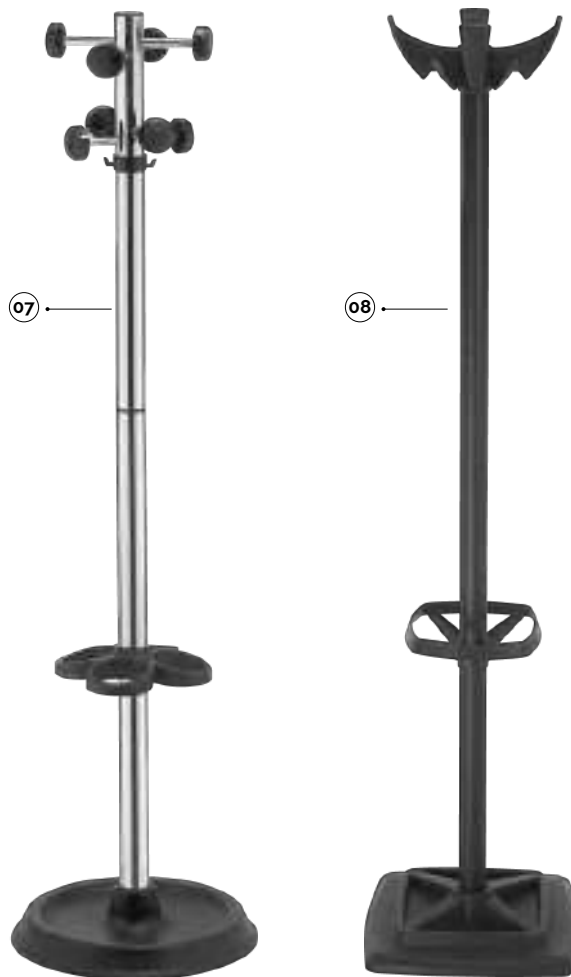

main component sizes

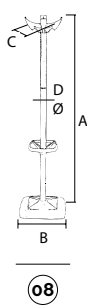
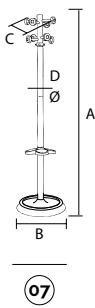

07 good-appendiabito a colonna con portaombrelli, componenti in plastica neri
good-coat hanger with umbrella stand, plastic components black

code	finishing	plastic	q.kit	q.pack	a	b	c	d	kg.x1	vol.x1
110403-050	● nero/black	● nero/black	x1	50	1720	430	330	50	5,00	mc. 0.045
110404-020	● grigio/grey	● nero/black	x1	50	1720	430	330	50	5,00	mc. 0.045
110410-030	● cromato/chrome	● nero/black	x1	50	1720	430	330	50	5,00	mc. 0.045

08 tree-appendiabito a colonna con portaombrelli, componenti in plastica neri
tree-coat hanger with umbrella stand, plastic components black

code	finishing	plastic	q.kit	q.pack	a	b	c	d	kg.x1	vol.x1
110403-065	● nero/black	● nero/black	x1	50	1730	450	300	50	4,00	mc. 0.05
110404-090	● grigio/grey	● nero/black	x1	50	1730	450	300	50	4,00	mc. 0.05
110410-070	● cromato/chrome	● nero/black	x1	50	1730	450	300	50	4,00	mc. 0.05

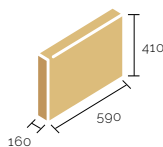
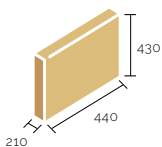



foot rings & columns



discover more about
Components Collection

La grande varietà di materiali e la qualità certificata CATAS e BIFMA, consentono di offrire una gamma di poggiatesta ampia e distintiva.

La linea prevede inoltre soluzioni tecnologicamente innovative come Gravity, il nuovo sistema di chiusura dell'anello poggiatesta che ha ottenuto il brevetto CATAS. Disegnato da uno studio di design prestigioso prevede infatti l'innovativa chiusura con leva che garantisce un migliore e più pratico fissaggio del poggiatesta.

The extensive range of materials combined with CATAS and BIFMA quality certifications enable us to offer an extensive and distinctive range of footrests.

The line also includes technologically innovative solutions such as Gravity, the new footrest ring locking system that has obtained a CATAS patent. Designed by a prestigious design studio the innovative lever-operated locking system assures better and more practical locking of the footrest.

foot rings

components

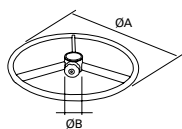

sg50t-anello poggiapiedi telescopico cromato completo di volantino
sg50t-telescopic foot ring chrome with little wheel

code	finishing	q.kit	q.pack	øa	øb	kg.x1	vol.x1
110210-008	● cromato/chrome	x1	10	450	50	1.60	mc. 0.008

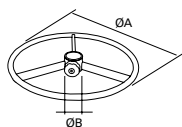

sg51t-anello poggiapiedi telescopico cromato completo di volantino
sg51t-telescopic foot ring chrome with little wheel

code	finishing	q.kit	q.pack	øa	øb	kg.x1	vol.x1
110210-081	● cromato/chrome	x1	10	500	50	1.90	mc. 0.008

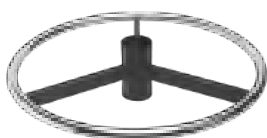
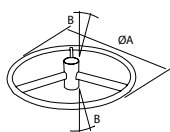

sg50f-anello poggiapiedi cromato
sg50f-fixed foot ring chrome

code	finishing	q.kit	q.pack	øa	øb	kg.x1	vol.x1
110210-005	● cromato/chrome	x1	10	450	1' 26' 16"	1.60	mc. 0.0125



patent



certification

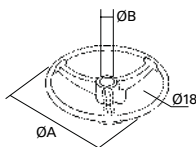

round-anello poggiapiedi telescopico con volantino
round-telescopic foot ring with little wheel

code	finishing	q.kit	q.pack	øa	øb	kg.x1	vol.x1
110210-009	● cromato/chrome	x1	10	450	50	1.40	mc. 0.0125



patent



certification



designed by:
Esedra

gravity-anello poggiapiedi telescopico cromato completo di leva
gravity-telescopic foot ring chrome with little lever

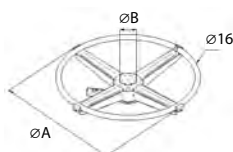

code	finishing	q.kit	q.pack	øa	øb	kg.x1	vol.x1
110210-006	● cromato/chrome	x1	10	450	50	1.10	mc. 0.0125

columns

components

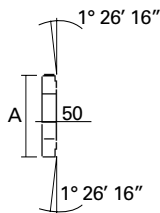

prolunga per anello poggiatesta fisso sg5f
pipe extension for foot ring sg50f

code	finishing	q.kit	q.pack	a	øb	kg.x1	vol.x1
112303-002	● nero/black	x1	50	130	50	0.24	mc. 0.0031
112310-031	● cromato/chrome	x1	50	130	50	0.24	mc. 0.0031
112303-004	● nero/black	x1	50	260	50	0.48	mc. 0.0062
112310-030	● cromato/chrome	x1	50	260	50	0.48	mc. 0.0062

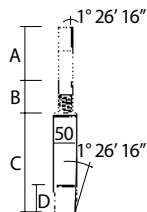

colonna alzata vite ø50, h 240
column screw ø50, h 240

code	finishing	q.kit	q.pack	a	b	c	d	kg.x1	vol.x1
112303-053	● nero/black	x1	30	130	80	240	50	0.81	mc. 0.0190
112310-002	● cromato/chrome	x1	30	130	80	240	50	0.81	mc. 0.0190

— altezza a richiesta
height on request

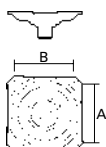
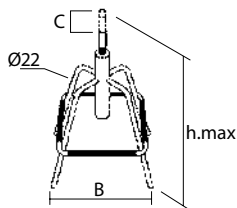
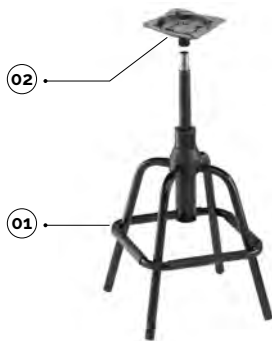

01 sg22-sgabelli con vite, tappi e accessori assemblati cono ø21 imballo singolo
sg22-stool with screw, caps and accessories assembled cono ø21 single packing

code	finishing	q.kit	q.pack	h.max	b	c	kg.x1	vol.x1
110603-035	● nero/black	x1	1	680	330	130	3.00	mc. 0.053
110610-075	● cromato/chrome	x1	1	680	330	130	3.00	mc. 0.053
110605-002	○ bianco/white	x1	1	680	330	130	3.00	mc. 0.053

02 piastra sgabello cono ø21
plate for stool cone ø21

code	finishing	q.kit	q.pack	a	b	kg.x1	vol.x1
113003-100	● nero/black	x1	20	140	140	0.85	mc. 0.001



slide bases



discover more about
Components Collection

L'ideale fondamento per ogni vostro progetto.

L'assortimento di basi Alba offre un grande numero di soluzioni in grado di rispondere alle più varie esigenze in termini di design, e di garantire i più elevati standard qualitativi.

The ideal foundation for all your projects.

The Alba range of bases offers a large selection of solutions capable of meeting the most varied needs in terms of design, and ensuring you the highest quality standards.

slide bases

components

main component sizes

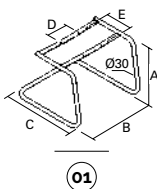

01 sl43-base a slitta in tubo ø30 tappi esclusi
sl43-slide frame pipe ø30 without caps

code	finishing	q.kit	q.pack	a	b	c	d	e	kg.x1	vol.x1
110503-003	● nero/black	x1	64	400	530	530	155	200	4,70	mc. 0.0313
110504-001	● grigio/grey	x1	64	400	530	530	155	200	4,70	mc. 0.0313
110510-020	● cromato/chrome	x1	64	400	530	530	155	200	4,70	mc. 0.0313

02 confezione tappi copritesta ø30 nero + pinze a due pioli p2p
black round cover head caps ø30 + two pins pliers in black polythene package

code	finishing	q.kit	q.pack
137003-077	● nero/black	tc30 (x2) - p2p (x6)	tc30 (130 pcs) - p2p (390 pcs)

main component sizes



certification

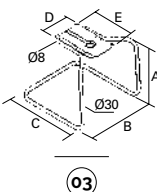

03 sl40-base a slitta in tubo ø25 tappi esclusi
sl40-slide frame pipe ø25 without caps

code	finishing	q.kit	q.pack	a	b	c	d	e	kg.x1	vol.x1
110503-021	● nero/black	x1	96	430	480	520	170	200	4,10	mc. 0.0313
110504-010	● grigio/grey	x1	96	430	480	520	170	200	4,10	mc. 0.0313
110510-002	● cromato/chrome	x1	96	430	480	520	170	200	4,10	mc. 0.0313

04 confezione tappi copritesta alettati ø25 neri + pinze a due pioli p2p
black round cover head caps ø25 + two pins pliers in black polythene package

code	finishing	q.kit	q.pack
137003-076	● nero/black	tc25 (x2) - p2p (x6)	tc25 (195 pcs) - p2p (580 pcs)

05 piedino antiribaltamento in plastica nero + 2 viti
plastic black feet anti-upsetting + 2 screws

code	finishing	q.kit
134303-006	● nero/black	x2

main component sizes

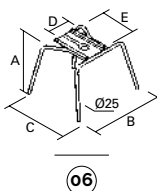

06 rg31-telaio fisso in tubo ø25 tappi esclusi
rg31-fixed frame pipe ø25 without caps

code	finishing	q.kit	q.pack	a	b	c	d	e	kg.x1	vol.x1
110603-012	● nero/black	x1	150	430	470	550	170	200	3,70	mc. 0.028
110604-041	● grigio/grey	x1	150	430	470	550	170	200	3,70	mc. 0.028
110610-017	● cromato/chrome	x1	150	430	470	550	170	200	3,70	mc. 0.028

07 puntale alettato tondo ø25 nero
ribbed round insert cap ø25 black

code	finishing	q.kit
134203-253	● nero/black	x4

slide bases

components

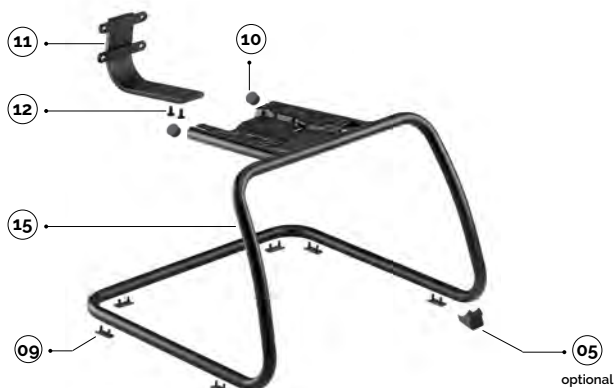

15 sl46-base a slitta in tubo 25 tappi esclusi
sl46-slide frame pipe ø25 without caps

code	finishing	q.kit	q.pack	a	b	c	kg.x1	vol.x1
110503-007	● nero/black	x1	64	590	560	400	4,50	mc. 0.032
110504-020	● grigio/grey	x1	64	590	560	400	4,50	mc. 0.032
110510-047	● cromato/chrome	x1	64	590	560	400	4,50	mc. 0.032

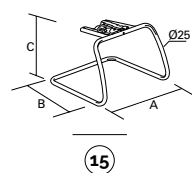

main component sizes

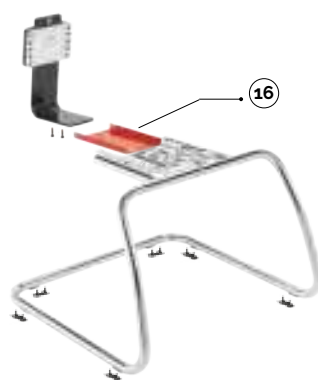

16 piastra adattatore per lama schienale
adapter plate for blade back

code	finishing	q.kit	q.pack	kg.x1	vol.x1
113003-150	● nero/black	x1	30	0,45	mc. 0.001

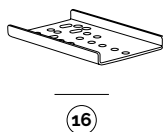

main component sizes



bases



discover more about
Components Collection

Le basi Alba garantiscono la migliore prestazione su qualsiasi tipo di seduta, grazie agli elevati standard qualitativi con cui vengono realizzate.

Componenti fondamentali per l'appoggio a terra di ogni scocca, si contraddistinguono per la massima versatilità e assicurano un assortimento completo, in grado di rispondere alle esigenze più varie, sia in termini di design sia di funzionalità.

Alba bases guarantee outstanding performance on any chair type, thanks to the high-quality standards used in their construction.

Fundamental components for providing a firm base for all seat shells, they are characterized by maximum versatility and provide a complete range capable of meeting the most varied needs, both in terms of design and functionality.

bases

components



certification

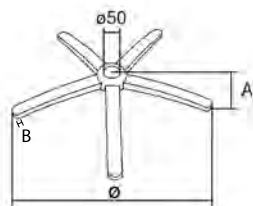

b40-base in metallo con coprisaldatura
b40-chrome metal base + welding cover

code	finishing	q.kit	q.pack	ø	a	b	kg.x1	vol.x1
110210-027	● cromato/chrome	x1	5	640	60	11	2,85	mc. 0.014
110210-024	● cromato/chrome	x1	5	700	65	11	3,18	mc. 0.020



certification

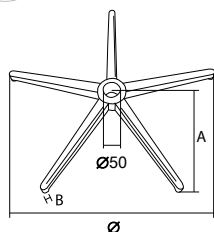

b50-base a 5 razze in metallo con coprisaldatura
b50-chrome metal base + welding cover

code	finishing	q.kit	q.pack	ø	a	b	kg.x1	vol.x1
110210-057	● cromato/chrome	x1	5	640	112	11	2,25	mc. 0.0117
110210-058	● cromato/chrome	x1	5	700	118	11	2,50	mc. 0.0126

main component sizes

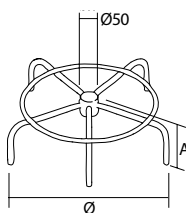
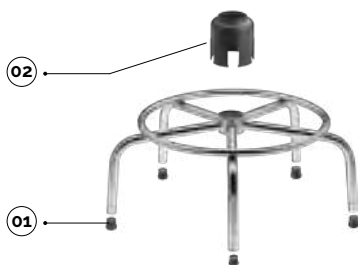

b30-base per sgabello con anello poggiapiedi cono ø50 tappi esclusi
b30-base for stool with footrest ring cone ø50 caps excluded

code	finishing	q.kit	q.pack	ø	a	kg.x1	vol.x1
110210-025	● cromato/chrome	x1	80	540	200	2,55	mc. 0.02

01 puntale alettato tondo ø20 nero
ribbed round insert cap ø20 black

code	finishing	q.kit
134203-200	● nero/black	x5

02 b30/csb-coprisaldatura foro d.50 nero
b30/csb-cover welding hole d.50 black

code	finishing	q.kit	q.pack	a	b	c	d	e	kg.x1
130203-000	● nero/black	x1	150	40	20	80	87	50	0,036

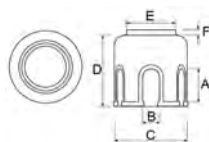





components



discover more about
Components Collection

Una linea completa di componenti e accessori per il mondo della seduta.

Un grande numero di soluzioni in grado di rispondere in maniera completa e funzionale alle esigenze più varie: staffe porta braccioli, piastre con leva opzionabili con copertina in plastica per telaio girevole, meccanismo ribaltabile e braccioli in metallo (o plastica) per panca, tavolette dalle varie forme (in plastica o legno) con snodi anche dotati di meccanismo antipanico.

Tutti i componenti e gli accessori Alba garantiscono design distintivo e tecnologia innovativa, oltre ai più elevati standard qualitativi.

A complete range of components and accessories for all types of chairs.

A large selection of highly functional solutions able to meet the most varied needs: armrest brackets, plates with optional lever and plastic cover for swivel frames, folding mechanisms and metal (or plastic) armrests for benches, writing tablets in various shapes (in plastic or wood) with swivel joints also equipped with anti-panic mechanisms.

All Alba components and accessories boast distinctive designs and innovative technology, as well as a guarantee of the highest quality standards.

components

components

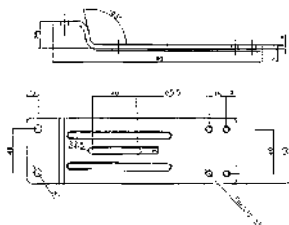

01 sb62-staffa portabracciolo
sb62-support of arm

code	finishing	q.kit	q.pack	kg.x1	vol.x1
113003-010	● nero/black	x1	50	0,50	mc. 0.0002

main component sizes

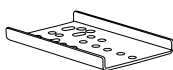

02 psal.nr-piastra adattatore per lama schienale
psal.nr.-adapter plate for blade back

code	finishing	q.kit	q.pack	kg.x1	vol.x1
113003-150	● nero/black	x1	30	0,45	mc. 0.001

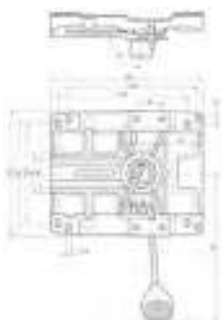

03 piastra a gas dattilo cono 28 con leva
seat place cone 28 with lever

code	finishing	q.kit	q.pack	kg.x1	vol.x1
113003-121	● nero/black	x1	20	1,23	mc. 0.002

components

components

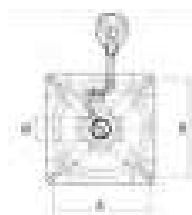

04 pss28nr - piastra sgabello c/spat. c/28 3' l4 nera
pss28nr - square metal plate with straight lever c/28 3' l4

code	finishing	q.kit	q.pack	a	b	ø	kg.x1	vol.x1
113003-104	● nero/black	x1	20	150	150	28	1,23	mc. 0,002

main component sizes



designed by:
Stefano Bettio

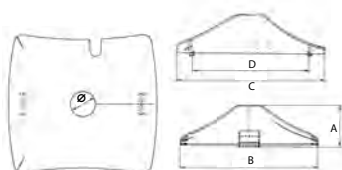
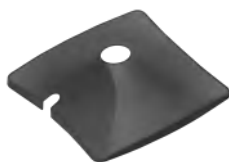

05 cpg-copertina in plastica per telaio girevole
cpg-plastic cover for swivel frame

code	finishing	q.kit	q.pack	a	b	c	d	ø	kg.x1	vol.x1
130903-000	● nero/black	x1	50	60	200	210	167	36	0,1	mc. 0,0015

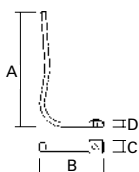

06 sh15-schienale in tubo ovale con cavalotto di rinforzo filettato
sh15-oval back with reinforcement threading black painted

code	finishing	q.kit	q.pack	a	b	c	d	kg.x1	vol.x1
112103-001	● nero/black	x1	50	330	215	30	15	0,62	mc. 0,0008

components

components

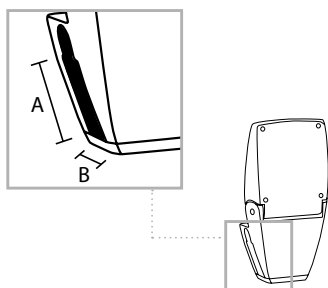

07 siton-meccanismo panca ribaltabile alluminio lucido
siton-polished aluminium folding mechanism

code	finishing	q.kit	q.pack	a	b	kg.x1	vol.x1
110704-180	○ alluminio/aluminium	x1	4	80	40	2,81	mc. 0,007



designed by:
Esedra

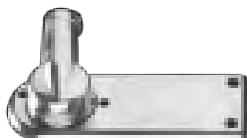

08 spta-snodo tavoletta antipanico in alluminio lucido
spta-polished aluminium swivel safety mechanism for tablet

code	finishing	q.kit	q.pack	a	b	c	kg.x1	vol.x1
111701-900	○ alluminio/aluminium destro/right	x1	10	180	66	15x15	0,365	mc. 0,001
111701-901	○ alluminio/aluminium sinistro/left	x1	10	180	66	15x15	0,365	mc. 0,001

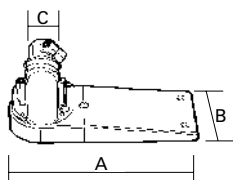

09 sptz-snodo per tavoletta in termoplastica
sptz-mechanism for writing tablet

code	finishing	q.kit	q.pack	a	b	c	kg.x1	vol.x1
134003-039	● nero/black	x1	20	180	66	15x15	0,35	mc. 0,0006

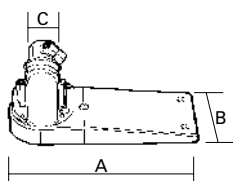

10 isoscele-aggancio laterale maschio + femmina in plastica con due viti
isoscele-plastic lateral hook male + female with 2 screws

code	finishing	q.kit	q.pack
134003-132	● nero/black	x2	100

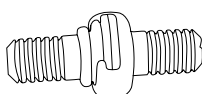

components

components

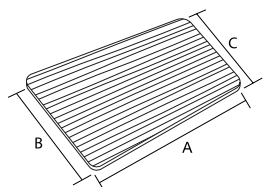

11 tlo2.cfd-tavoletta legno c/prefori dx verniciata faggio
tlo2.cfd-right painted beechwood tablet

code	finishing	q.kit	q.pack	a	b	c	kg.x1	vol.x1
120307-021	● faggio/beech	x1	10	342	245	196	0,65	mc. 0,009

tlo2.cfs-tavoletta legno c/prefori sx verniciata faggio
tlo2.cfs-left painted beechwood tablet

code	finishing	q.kit	q.pack	a	b	c	kg.x1	vol.x1
120307-022	● faggio/beech	x1	10	342	245	196	0,65	mc. 0,009

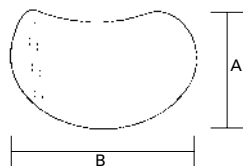

12 bean-tavoletta in termoplastico spessore 16 mm
bean-writing tablet in plastic thickness 16 mm

code	finishing	q.kit	q.pack	a	b	kg.x1	vol.x1
134003-044	● nero/black	x1	20	235	370	0,40	mc. 0,002

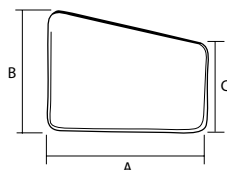

13 tlt-tavoletta in termoplastico spessore 16 mm
tlt-writing tablet in plastic thickness 16 mm

code	finishing	q.kit	q.pack	a	b	c	kg.x1	vol.x1
134003-042	● nero/black	x1	20	345	260	200	0,40	mc. 0,002

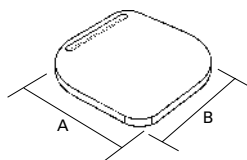

14 tlt2-tavoletta in termoplastico ovale spessore 16 mm per bracciolo destro e sinistro
tlt2-writing tablet in oval plastic thickness 16 mm for left and right arms

code	finishing	q.kit	q.pack	a	b	kg.x1	vol.x1
134003-040	● nero/black	x1	20	271	271	0,40	mc. 0,002

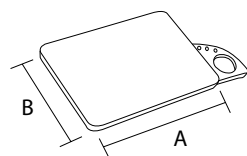

15 tlt3-tavoletta ambidestro con portabicchiere e portapenne
tlt3-writing tablet with cup holder and pen tray

code	finishing	q.kit	q.pack	a	b	kg.x1	vol.x1
134003-041	● nero/black	x1	10	370	255	1,05	mc. 0,036



e:usb



discover more about
E:Usb Collection

La soluzione funzionale, innovativa e di design.

Progettata per migliorare l'attesa nelle aree Community, consente agli utenti di caricare i propri devices stando comodamente seduti.

E:Usb è pensata per tutte le Aree d'attesa.

Designer solution which is functional and innovative.

E:Usb is the Alba solution that helps improve the experience of users while waiting in Community areas, allowing them to charge their devices while comfortably seated.

E:Usb is designed for all waiting areas.

Plus

- Si adatta a qualsiasi modello di trave per panca con sezione 80X40mm.
- Può essere utilizzata per due dispositivi contemporaneamente.
- Stile minimal grazie alla forma arrotondata e al colore in nero/grigio.
- Adapts to any model of beam for bench with section 80X40mm.
- Can be used to charge two devices simultaneously.
- Discreet styling thanks to the rounded shape and black/grey colour.

e:usb

components

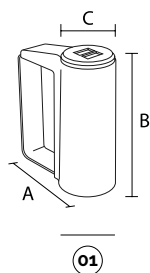

main component sizes

01 e:usb-caricatore per panca
e:usb-bench plug

code	finishing	q.kit	q.pack	a	b	c	kg.x1	vol.x1
130703-002	● nero/black	x1	5	85	100	38	0,28	mc. 0,0009



puoi caricare fino a due dispositivi contemporaneamente
you can charge up to two devices simultaneously



e:usb

components



bench components

components



designed by:
R&D Alba

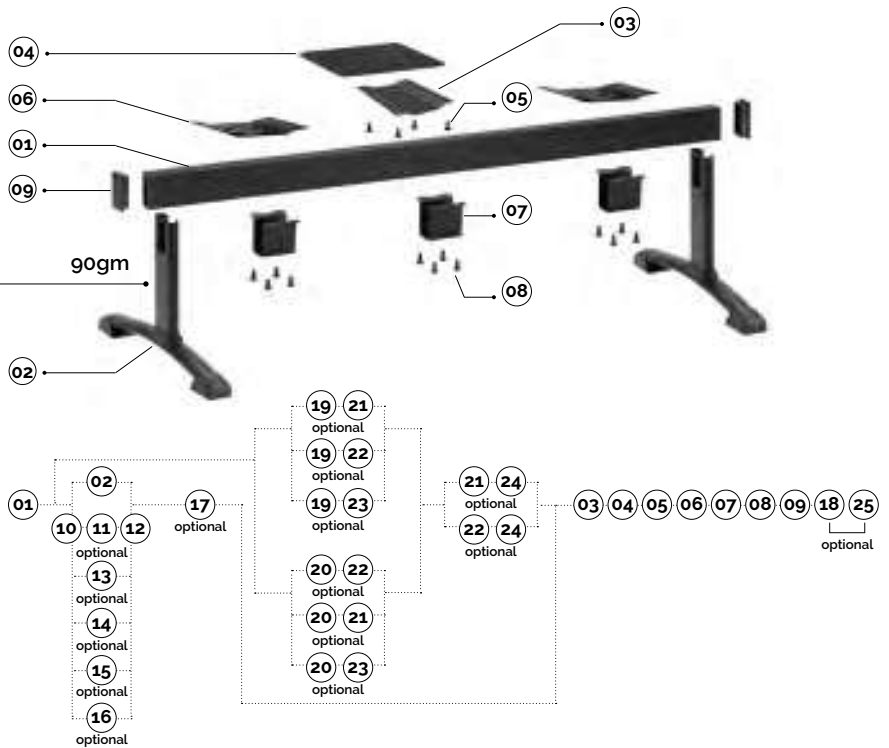

main component sizes

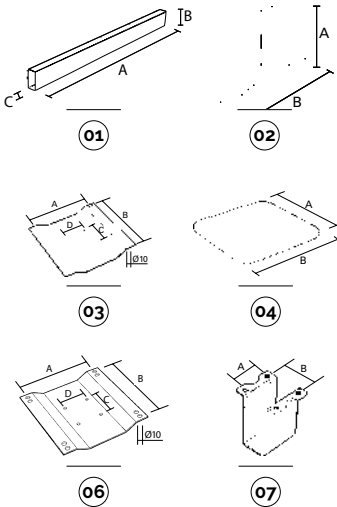

01 90t-trave per panca got-beam for bench

code	finishing		q.kit	q.pack	a	b	c	kg.x1	vol.x1
110703-020	● nero/black	2 posti/2 seats	x1	1	1000	80	40	2,80	mc. 0,003
110704-043	● grigio/grey	2 posti/2 seats	x1	1	1000	80	40	2,80	mc. 0,003
110703-021	● nero/black	3 posti/3 seats	x1	1	1500	80	40	4,20	mc. 0,0045
110704-044	● grigio/grey	3 posti/3 seats	x1	1	1500	80	40	4,20	mc. 0,0045
110703-022	● nero/black	4 posti/4 seats	x1	1	2000	80	40	5,60	mc. 0,006
110704-045	● grigio/grey	4 posti/4 seats	x1	1	2000	80	40	5,60	mc. 0,006
110703-023	● nero/black	5 posti/5 seats	x1	1	2500	80	40	7,00	mc. 0,0085
110704-046	● grigio/grey	5 posti/5 seats	x1	1	2500	80	40	7,00	mc. 0,0085

02 90gm-gamba mobile per panca con accessori 90gm-movable leg for bench with accessories

code	finishing		q.kit	q.pack	a	b	kg.x1	vol.x1
110703-005	● nero/black		x2	2	380	600	2,70	mc. 0,012
110704-001	● grigio/grey		x2	2	380	600	2,70	mc. 0,012
110710-001	● cromato/chrome		x2	2	380	600	2,70	mc. 0,012

03 90ap-attacco porta piano 90ap-table attachment

code	finishing		q.kit	q.pack	a	b	c	d	kg.x1	vol.x1
110703-014	● nero/black		x1	25	170	200	65	55	1,00	mc. 0,0002
110704-019	● grigio/grey		x1	25	170	200	65	55	1,00	mc. 0,0002

04 90tn-piano tavolo per panca 90tn-table for bench

code	finishing		q.kit	q.pack	a	b	kg.x1	vol.x1
120303-001	● nero/black		x1	10	400	400	2,20	mc. 0,002

05 vite tc + m6x12 brunita nera screw tc + m6x12 burnishing black

code	finishing		q.kit
117703-177	● nero/black		x4

06 92p-piastra per panca verniciata 92p-plate for bench paint

code	finishing		q.kit	q.pack	a	b	c	d	kg.x1	vol.x1
110703-013	● nero/black		x1	20	153	200	65	55	0,85	mc. 0,0008

07 90cv-cavalotto sotto trave 90cv-support under beam

code	finishing		q.kit	q.pack	a	b	kg.x1	vol.x1
110703-007	● nero/black		x1	50	55	65	0,60	mc. 0,0005
110704-015	● grigio/grey		x1	50	55	65	0,60	mc. 0,0005

08 confezione vite m8x12 testa cilindrica esagonale incassato brunita nera screw m8x12 cylindrical head hexagon embedded burnishing black package

code	finishing		q.kit	q.pack
117003-070	● nero/black		x4	200

09 tappo copritesta rettangolare 80x40 nero rectangular cover head cap 80x40 black

code	finishing		q.kit
134103-001	● nero/black		x2

bench leg & arm options

components

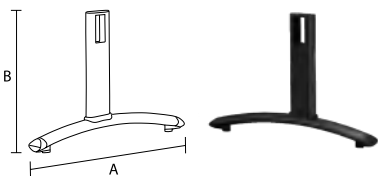

16 91gm-gamba mobile per panca con accessori
91gm-movable leg for bench with accessories

code	finishing	q.kit	q.pack	a	b	kg.x1	vol.x1
110703-581	● nero/black	x2	2	620	376	2,7	mc. 0.03
110704-581	● grigio/grey IG2621	x2	2	620	376	2,7	mc. 0.03
110704-582	● grigio/grey drylac	x2	2	620	376	2,7	mc. 0.03
110705-581	○ bianco/white ral 9010	x2	2	620	376	2,7	mc. 0.03
110710-581	● cromato/chrome	x2	2	620	376	2,7	mc. 0.03

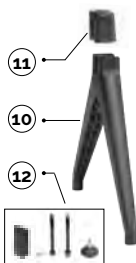
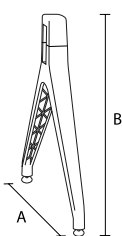

10 jim-gamba in plastica nera
jim-plastic bench leg_black



Jim / certified product

code	finishing	q.kit	q.pack	a	b	kg.x1	vol.x1
130703-004	● nero/black	x2	10	630	425	0,95	mc. 0.0102

11 jim-cavalotto x fissaggio gamba nero in plastica
jim-plastic bracket for bench leg - black

code	finishing	q.kit	q.pack	kg.x1	vol.x1
130703-005	● nero/black	x2	10	0,16	mc. 0.0005

12 jim-confezione accessori x 10 gambe
jim-accessories bag for 10 legs

code	finishing	q.kit	q.pack	kg.x1	vol.x1
130703-007	● nero/black	x0,2	1	0,15	mc. 0.0004

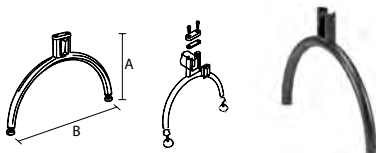

13 100gm-gamba mobile per panca con accessori
100gm-movable leg for bench with accessories

code	finishing	q.kit	q.pack	a	b	kg.x1	vol.x1
110703-008	● nero/black	x2	2	380	600	2,10	mc. 0.012
110704-006	● grigio/grey	x2	2	380	600	2,10	mc. 0.012
110710-005	● cromato/chrome	x2	2	380	600	2,10	mc. 0.012

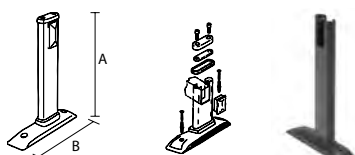

14 90gf-gamba fissa per panca con accessori
90gf-fixed leg for bench with accessories

code	finishing	q.kit	q.pack	a	b	kg.x1	vol.x1
110703-030	● nero/black	x2	2	380	310	1,90	mc. 0.012
110704-012	● grigio/grey	x2	2	380	310	1,90	mc. 0.012

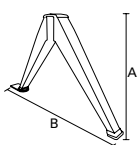

15 200gm-gamba mobile per panca con accessori
200gm-movable leg for bench with accessories



designed by: Stefano Bettio

code	finishing	q.kit	q.pack	a	b	kg.x1	vol.x1
110703-110	● nero/black	x2	4	380	600	2,60	mc. 0.005
110704-110	● grigio/grey	x2	4	380	600	2,60	mc. 0.005
110710-110	● cromato/chrome	x2	4	380	600	2,60	mc. 0.005

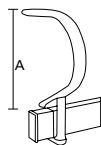

17 pioneer-bracciolo ellittico 40x20 per panca con accessori
pioneer-elliptical 40x20 arm for bench with accessories

code	finishing	q.kit	q.pack	a	kg.x1	vol.x1
111703-015	● nero/black	x1	5	260	1,10	mc. 0.005
111704-015	● grigio/grey	x1	5	260	1,10	mc. 0.005
111710-015	● cromato/chrome	x1	5	260	1,10	mc. 0.005

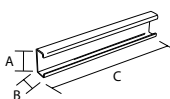

18 connettore trave panca
beam bench connector

code	finishing	q.kit	q.pack	a	b	b	kg.x1
110703-025	● nero/black	x1	10	75	36	400	1,42

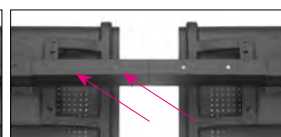
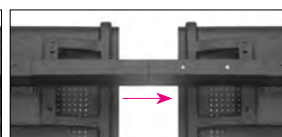
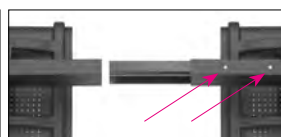
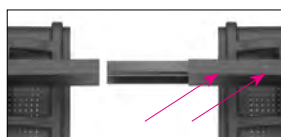
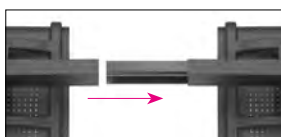

01

02

03

04

05

components / cut & slim options

designed by:
Alessandro Crosera

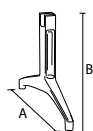

19 cut-gamba in alluminio per gamba panca + n'2 piedini
cut-aluminium leg for bench + n'2 glides

code	finishing	q.kit	q.pack	a	b	kg.x1	vol.x1
111704-224	○ alluminio/aluminium	x2	5	615	350	2,75	mc. 0,0132

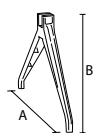

20 slim-gamba in alluminio per gamba panca + n'2 piedini
slim-aluminium leg for bench + n'2 glides

code	finishing	q.kit	q.pack	a	b	kg.x1	vol.x1
111704-226	○ alluminio/aluminium	x2	5	610	350	1,3125	mc. 0,0102



21 cut-bracciolo in alluminio per panca + n'2 viti
cut- aluminium arm for bench + n'2 screws

code	finishing	q.kit	q.pack	a	b	kg.x1	vol.x1
111704-223	○ alluminio/aluminium	x1	10	300	305	1,6065	mc. 0,0028

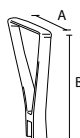

22 slim-bracciolo in alluminio per panca + n'2 viti
slim- aluminium arm for bench + n'2 screws

code	finishing	q.kit	q.pack	a	b	kg.x1	vol.x1
111704-225	○ alluminio/aluminium	x1	10	325	305	1,464	mc. 0,0049



23 cut/slim-cavalotto in alluminio per gamba panca + n'2 viti
cut/slim aluminium bracket 80x40 for bench leg + n'2 screws

code	finishing	q.kit	q.pack	a	b	kg.x1	vol.x1
111704-222	○ alluminio/aluminium	x2	10	60	95	0,30	mc. 0,0005

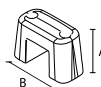

24 cut/slim-cavalotto in alluminio per bracciolo panca
cut/slim aluminium bracket 80x40 for bench arm

code	finishing	q.kit	q.pack	a	b	kg.x1	vol.x1
111704-221	○ alluminio/aluminium	x1	10	58	95	0,38	mc. 0,0005

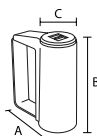

25 e:usb-caricatore per panca
e:usb-bench plug

code	finishing	q.kit	q.pack	a	b	c	kg.x1	vol.x1
130703-002	● nero/black	x1	5	85	100	38	0,28	mc. 0,0009

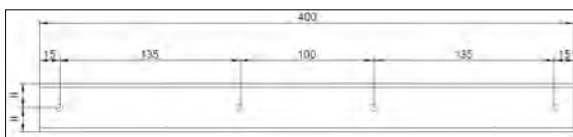
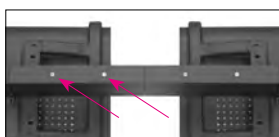

trama di foratura consigliata, lato inferiore trave
hole pattern suggested, underneath side of the beam

alba

2 0 2 5
CATALOGUE

art direction & design

seventyseven

photo

photopiù

print

graficasette

alba.

alba.it

Alba is a brand by Metalmeccanica Alba srl

via Boschier, 54/A
31020 San Zenone degli Ezzelini (TV)
info@alba.it
T. +39 0423 969700