

alba. 

2 0 2 5
CATALOGUE

FRA/ESP

2025
CATALOGUE



362

90



274

ala



260

aria



396

bases



417

bench components



90

clever



374

coat hangers

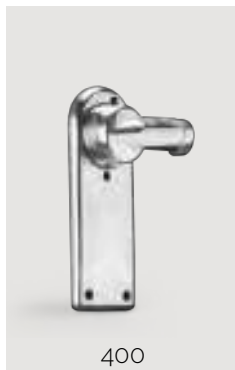

400

components



94

contract tables



282

duetto



348

eden



406

e:usb



152

feel



190

flash



388

foot rings &
columns



28

gemma



10

genesi



66

jota



42

lemon



214

logan

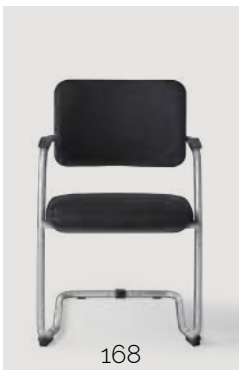

168

magix



290

manila

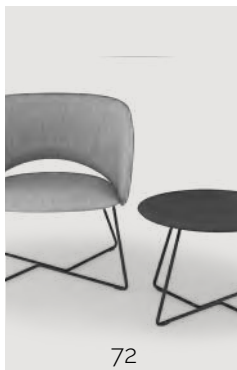

72

maui



82

meti



132

modula

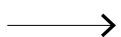

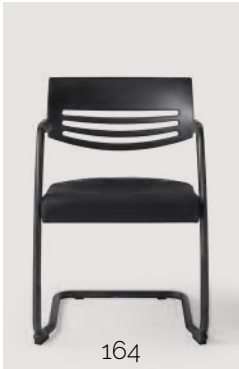

164

moon



266

nexus



328

oki



352

paco



228

pinko



298

pluto



314

pull



320

q5



196

q9



334

race



278

siton



392

slide bases



342

smile



116

spot



202

square



106

tapas



306

teddy



86

tipper



120

unyo



356

vicenza



142

wing



242

x3



56

xylo



180

young/key/fabric



out of catalogue

athos



out of catalogue

butterfly

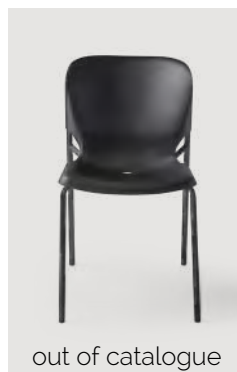

out of catalogue

perù



out of catalogue

q9 4-legs



out of catalogue

stella base

disponible avec quantité minimum du bon de commande
disponible con cantidad minima de orden de compra

à propos de nous



Alba, fondata in 1981, est une entreprise italienne bien établie dans la conception et la production de solutions d'ameublement polyvalentes et de qualité. Avec une large gamme de chaises, de tables et d'autres éléments de mobilier, Alba propose des collections qui combinent un design innovant, la fonctionnalité, la praticité et un rapport qualité-prix équilibré.

Nos années d'expérience nous permettent de réaliser des produits complets, proposés en kits prêts à monter. De la conception à la production, dans nos établissements en Italie, nous sommes un partenaire fiable pour les entreprises du secteur de l'ameublement - des univers Community et Office à Contract et Ho.Re.Ca.

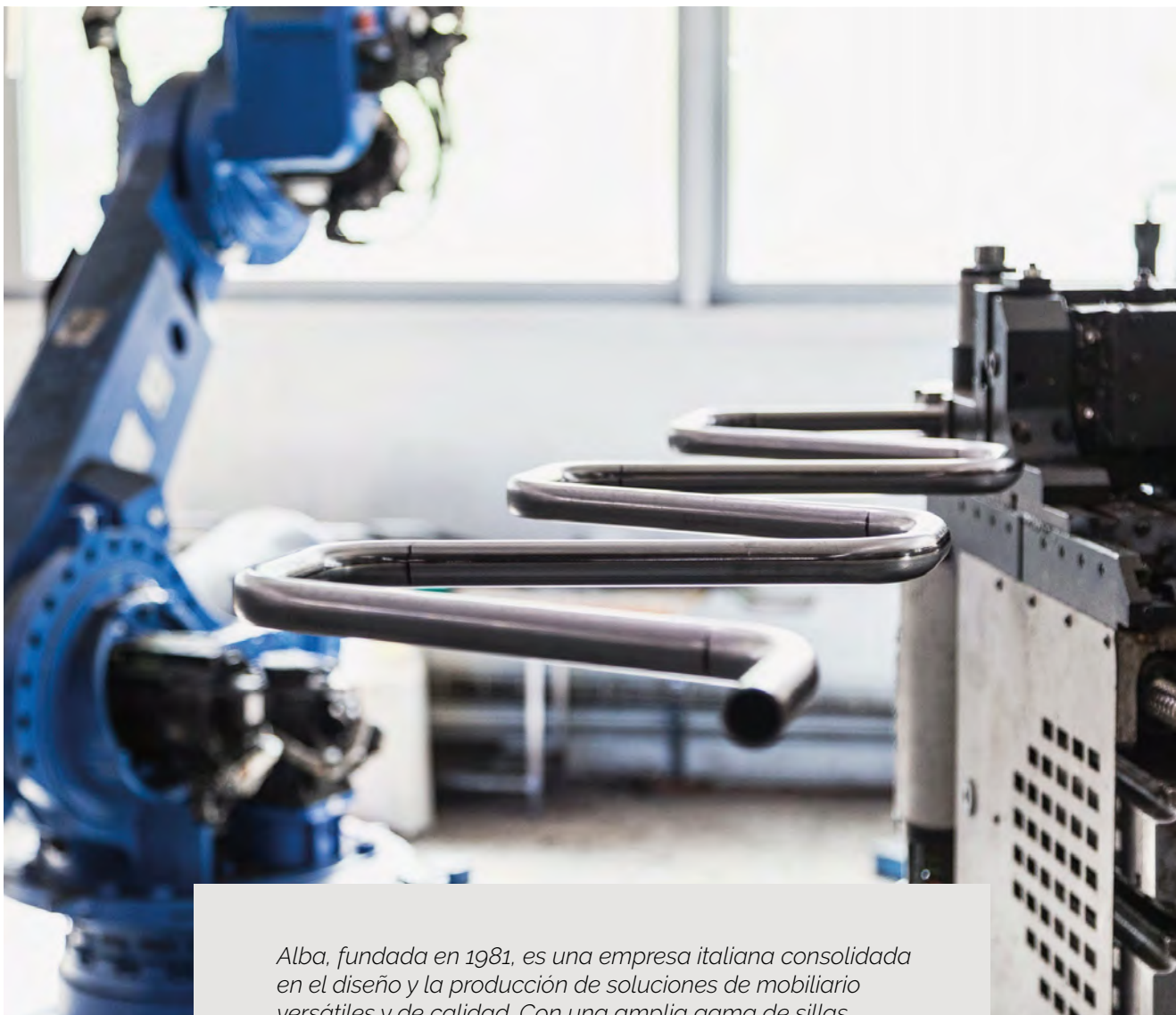

Alba, fundada en 1981, es una empresa italiana consolidada en el diseño y la producción de soluciones de mobiliario versátiles y de calidad. Con una amplia gama de sillas, mesas y otros elementos de mobiliario, Alba ofrece colecciones que combinan diseño innovador, funcionalidad, practicidad y una equilibrada relación calidad-precio.

Nuestra experiencia nos permite fabricar productos completos, que se ofrecen en kits listos para montar. Desde el diseño hasta la producción, en nuestras instalaciones de Italia, nos posicionamos como un socio fiable para las empresas del sector del mueble, desde el mundo comunitario y de oficina hasta el Contract y Ho.Re.Ca.

sobre nosotros

alba.

catalogue | intro



Ce catalogue général regroupe l'ensemble de notre large gamme de solutions d'ameublement. Chaque collection est présentée avec une logique de kit de montage intuitif qui facilitera la compréhension, y compris les aspects techniques, des produits.

Les collections Alba vont des chaises, tables et tabourets aux bancs d'attente, canapés, fauteuils, étagères et porte-manteaux. Chaque produit combine de manière équilibrée un design innovant, une fonctionnalité pratique et un bon rapport qualité-prix.

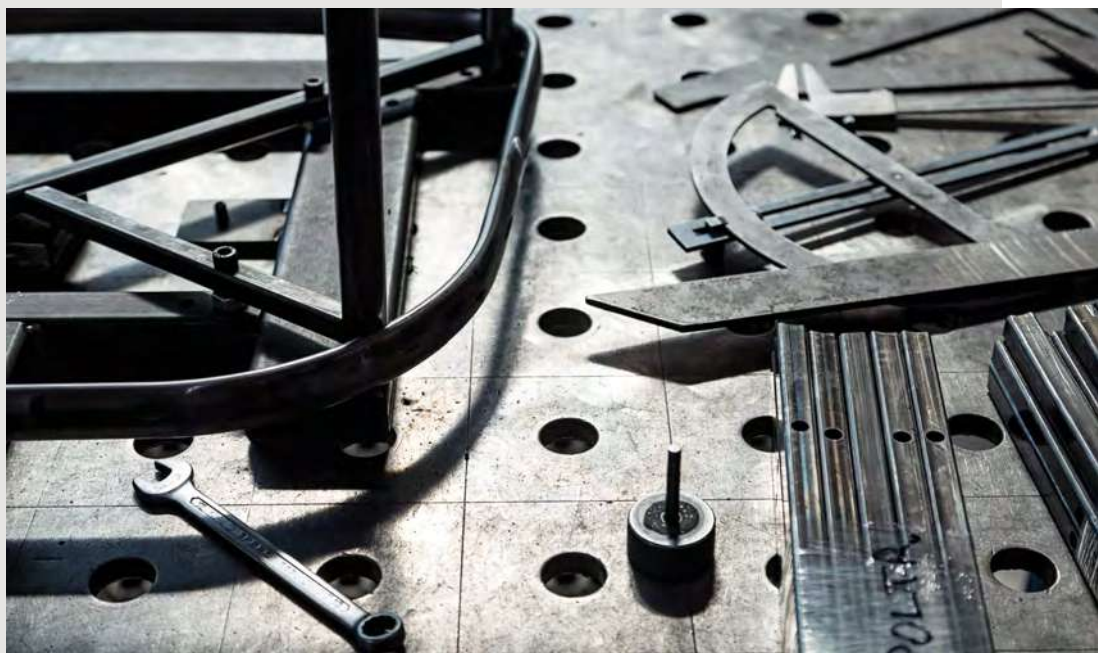

Este catálogo general reúne toda nuestra amplia gama de soluciones de mobiliario. Cada colección se presenta con una lógica intuitiva de kit de montaje que facilitará la comprensión y los aspectos técnicos de los productos.

Las colecciones Alba abarcan desde sillas, mesas y taburetes hasta bancos de espera, sofás, sillones, estanterías y percheros. Nuestros productos están pensados para combinar de forma equilibrada diseño innovador, funcionalidad, practicidad y una relación calidad-precio equilibrada.

catálogo | intro



genesis



discover more about
Genesi Collection

Genesi est un système de sièges polyvalent orienté vers la flexibilité d'utilisation et la complétude.

En effet, il offre de nombreuses options de combinaison entre châssis, bases, dossiers, assises et accessoires, s'adaptant ainsi à divers contextes d'utilisation tels que les bureaux, les salles de conférence, les environnements éducatifs et les espaces de coworking.

Genesi es un sistema de asientos versátil orientado a la flexibilidad y completitud de empleo.

De hecho, ofrece numerosas opciones de combinación entre estructuras, bases, respaldos, asientos y accesorios, adaptándose así a diversos contextos de uso como oficinas, salas de conferencias, entornos educativos y espacios de coworking.

Plus

- Assemblage par emboîtement rapide et facile, sans vis.
- Système d'installation des accoudoirs innovant et breveté.
- Certification EN 16139:2013 Niveau 2. Certification ANSI/BIFMA X5.1.
- Large choix de couleurs, de finitions et d'accessoires.
- *Montaje rápido y sencillo por enclavamiento, sin tornillos.*
- *Sistema patentado y innovador de instalación del reposabrazos.*
- *Certificación EN 16139:2013 Nivel 2. Certificación ANSI/BIFMA X5.1.*
- *Amplia gama de colores, acabados y accesorios.*



designed by:
Emanuele Bertolini



**trolley
available**



**certified
product**



**patented
product**

genesis

4-legs

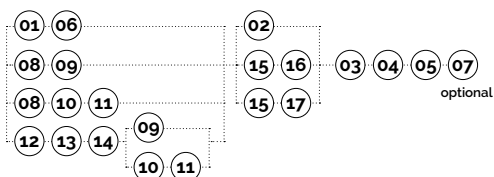
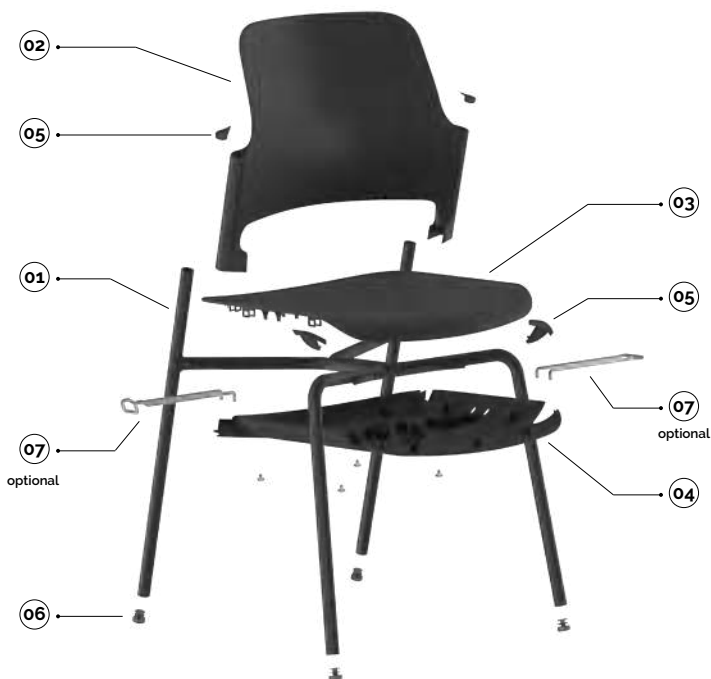
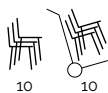

plastic colours

- noir/negro
- blanc/blanco
- gris/gris
- bleu/azul

main component sizes

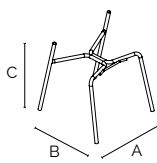

01

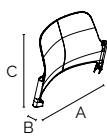

02

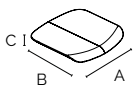

03

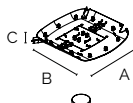

04



05



06

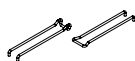

07



01 genesis - châssis 4 pieds ø.22 sans embouts genesis - estructura de 4 patas ø.22 sin tapones

code	finishing	q.kit	q.pack	a	b	c	kg.x1	vol.x1
110103-564	● noir/negro	x1	72	545	555	605	3,92	mc. 0.08
110105-564	● blanc/blanco	x1	72	545	555	605	3,92	mc. 0.08
110104-564	● gris/gris	x1	72	545	555	605	3,92	mc. 0.08
110110-564	● chromé/cromado	x1	72	545	555	605	3,92	mc. 0.08

02 genesis - dossier en plastique coloré genesis - respaldo a vista de plástico de color

code	finishing	q.kit	q.pack	a	b	c	kg.x1	vol.x1
132103-100	● noir/negro	x1	10	530	205	395	1,05	mc. 0.017
132105-100	● blanc/blanco	x1	10	530	205	395	1,05	mc. 0.017
132104-100	● gris/gris	x1	10	530	205	395	1,05	mc. 0.017
132115-100	● bleu/azul	x1	10	530	205	395	1,05	mc. 0.017

03 genesis - siège en plastique coloré genesis - asiento de plástico de color

code	finishing	q.kit	q.pack	a	b	c	kg.x1	vol.x1
132203-091	● noir/negro	x1	10	460	500	55	0,95	mc. 0.017
132205-091	● blanc/blanco	x1	10	460	500	55	0,95	mc. 0.017
132204-091	● gris/gris	x1	10	460	500	55	0,95	mc. 0.017
132215-091	● bleu/azul	x1	10	460	500	55	0,95	mc. 0.017

04 genesis - assise externe en plastique pour châssis 4 pieds et luge + entretoises en pvc genesis - asiento inferior de plástico para estructura de 4 patas y patin + parachoques de cabeza redondeada en pvc

code	finishing	q.kit	q.pack	a	b	c	kg.x1	vol.x1
132203-092	● noir/negro	x1	10	505	495	50	0,75	mc. 0.017
132205-092	● blanc/blanco	x1	10	505	495	50	0,75	mc. 0.017
132204-092	● gris/gris	x1	10	505	495	50	0,75	mc. 0.017
132215-092	● bleu/azul	x1	10	505	495	50	0,75	mc. 0.017

05 genesis - embouts pour dossier sans accoudoirs + paire d'accessoires pour siège sans accoudoirs genesis - tapones de respaldo sin reposabrazos + bolsa de accesorios para asiento sin reposabrazos

code	finishing	q.kit	q.pack	kg.x1
131703-104	● noir/negro	x1	10	0,015
131705-104	● blanc/blanco	x1	10	0,015
131704-104	● gris/gris	x1	10	0,015
131715-104	● bleu/azul	x1	10	0,015

06 genesis - sac des embouts rondes noires d.22 genesis - bolsa de puntas redondas d.22 negro

code	finishing	q.kit	q.pack
137003-073	● noir/negro	x4	290

07 genesis - paire des accroches latérales chromés mâle + femelle genesis - pareja de ganchos laterales cromados macho + hembra

code	finishing	q.kit	kg.x1	vol.x1
113410-100	● chromé/cromado	x1	0,13	mc. 0.0004

32 genesis - chariot porte-chaises avec accessoires genesis - carro de sillas con accesorios

code	finishing	q.kit
110803-444	● noir/negro	x1

genesi

4-legs/frame options

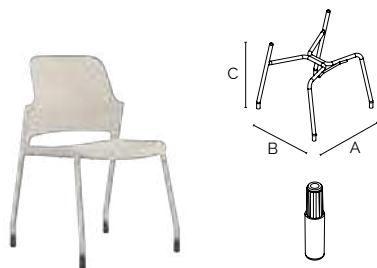

08 genesi - châssis 4 pieds pour roulettes et pieds hauts
genesi - estructura de 4 patas para ruedas y patas altas

code	finishing	q.kit	q.pack	a	b	c	kg.x1	vol.x1
110103-571	● noir/negro	x1	80	525	510	545	3.30	mc. 0.017
110105-571	● blanc/blanco	x1	80	525	510	545	3.30	mc. 0.017
110104-571	● gris/gris	x1	80	525	510	545	3.30	mc. 0.017
110110-571	● chromé/cromado	x1	80	525	510	545	3.30	mc. 0.017

09 genesi - pied haut (pour châssis pour roulettes)
genesi - pie alto (para estructura de ruedas)

code	finishing	q.kit
134303-064	● noir/negro	x4



08 genesi - châssis 4 pieds pour roulettes et pieds hauts
genesi - estructura de 4 patas para ruedas y patas altas

code	finishing	q.kit	q.pack	a	b	c	kg.x1	vol.x1
110103-571	● noir/negro	x1	80	525	510	545	3.30	mc. 0.017
110105-571	● blanc/blanco	x1	80	525	510	545	3.30	mc. 0.017
110104-571	● gris/gris	x1	80	525	510	545	3.30	mc. 0.017
110110-571	● chromé/cromado	x1	80	525	510	545	3.30	mc. 0.017

10 genesi - réducteur rayé pour roulettes (pour châssis pour roulettes)
genesi - reductor rayado (para estructura de ruedas)

code	finishing	q.kit
134303-051	● noir/negro	x4

11 genesi - roulette double d.50 à desmopan avec goupille montée
genesi - doble rueda d.50 de desmopan con perno montado

code	finishing	q.kit	kg.x1
134403-003	● noir/negro	x5	0.05

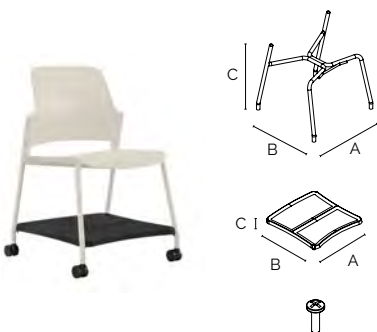

12 genesi - châssis 4 pieds pour roulettes et pieds hauts avec trous pour plateau de stockage
genesi - estructura de 4 patas con agujeros para cesto (para ruedas y patas altas)

code	finishing	q.kit	q.pack	a	b	c	kg.x1	vol.x1
110103-573	● noir/negro	x1	80	525	510	545	3.30	mc. 0.017
110105-573	● blanc/blanco	x1	80	525	510	545	3.30	mc. 0.017
110104-573	● gris/gris	x1	80	525	510	545	3.30	mc. 0.017
110110-573	● chromé/cromado	x1	80	525	510	545	3.30	mc. 0.017

13 genesi - plateau de stockage
genesi - bandeja portaobjetos

code	finishing	q.kit	q.pack	a	b	c
134003-225	● noir/negro	x1	10	512	530	40

14 genesi - vis autotaraudeuse TC+ 5,5x19 galvanisée blanche (pour plateau de stockage)
genesi - tornillo autorroscante TC+ 5,5x19 galvanizado blanco (para bandeja)

code	finishing	q.kit
117811-180	● galvanisé/galvanizado	x4

4-legs/backrest options

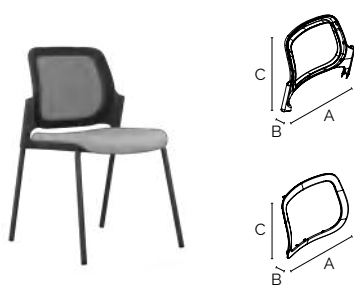

15 genesi - châssis porteur de dossier en plastique
genesi - estructura de respaldo de plástico

code	finishing	q.kit	q.pack	a	b	c	kg.x1	vol.x1
132103-101	● noir/negro	x1	10	530	220	405	0.75	mc. 0.017
132105-101	● blanc/blanco	x1	10	530	220	405	0.75	mc. 0.017
132104-101	● gris/gris	x1	10	530	220	405	0.75	mc. 0.017
132115-101	● bleu/azul	x1	10	530	220	405	0.75	mc. 0.017

16 genesi - cadre de dossier en plastique pour treillis
genesi - marco de respaldo de plástico para red

code	finishing	q.kit	q.pack	a	b	c	kg.x1	vol.x1
132103-103	● noir/negro	x1	10	425	140	355	0.30	mc. 0.004
132105-103	● blanc/blanco	x1	10	425	140	355	0.30	mc. 0.004
132104-103	● gris/gris	x1	10	425	140	355	0.30	mc. 0.004
132115-103	● bleu/azul	x1	10	425	140	355	0.30	mc. 0.004

15 genesi - châssis porteur de dossier en plastique
genesi - estructura de respaldo de plástico

code	finishing	q.kit	q.pack	a	b	c	kg.x1	vol.x1
132103-101	● noir/negro	x1	10	530	220	405	0.75	mc. 0.017
132105-101	● blanc/blanco	x1	10	530	220	405	0.75	mc. 0.017
132104-101	● gris/gris	x1	10	530	220	405	0.75	mc. 0.017
132115-101	● bleu/azul	x1	10	530	220	405	0.75	mc. 0.017

17 genesi - panneau en plastique pour dossier à tapisser
genesi - tablero de plástico por tapizar

code	finishing	q.kit	q.pack	a	b	c	kg.x1	vol.x1
132103-102	● noir/negro	x1	10	425	140	355	0.674	mc. 0.004
132105-102	● blanc/blanco	x1	10	425	140	355	0.674	mc. 0.004
132104-102	● gris/gris	x1	10	425	140	355	0.674	mc. 0.004
132115-102	● bleu/azul	x1	10	425	140	355	0.674	mc. 0.004

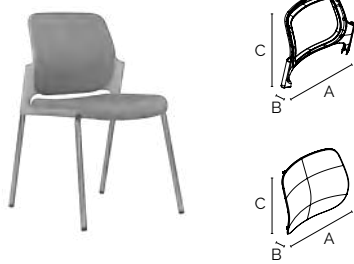

genesis

4-legs with armrests

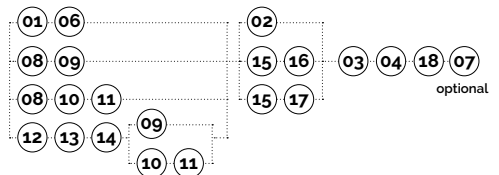
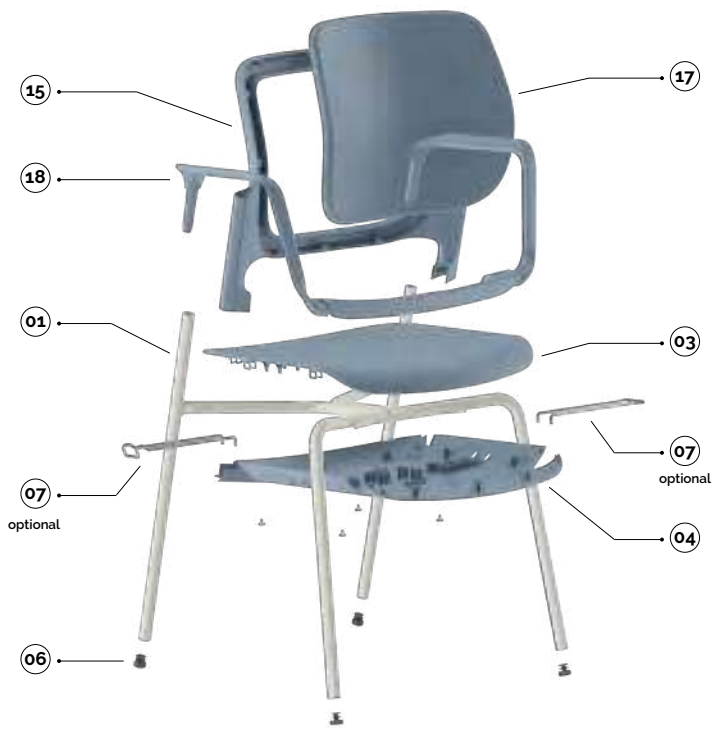
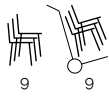

plastic colours

- noir/negro
- blanc/blanco
- gris/gris
- bleu/azul

main component sizes

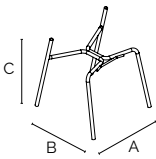

01

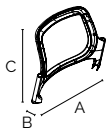

15

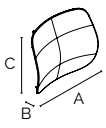

17

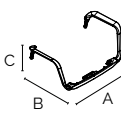

18

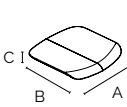

03

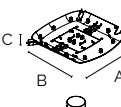

04



06



07

01 genesis - châssis 4 pieds ø.22 sans embouts
genesis - estructura de 4 patas ø.22 sin tapones

code	finishing	q.kit	q.pack	a	b	c	kg.x1	vol.x1
110103-564	● noir/negro	x1	72	545	555	605	3,92	mc. 0,08
110105-564	● blanc/blanco	x1	72	545	555	605	3,92	mc. 0,08
110104-564	● gris/gris	x1	72	545	555	605	3,92	mc. 0,08
110110-564	● chromé/cromado	x1	72	545	555	605	3,92	mc. 0,08

15 genesis - châssis porteur de dossier en plastique
genesis - estructura de respaldo de plástico

code	finishing	q.kit	q.pack	a	b	c	kg.x1	vol.x1
132103-101	● noir/negro	x1	10	530	220	405	0,75	mc. 0,017
132105-101	● blanc/blanco	x1	10	530	220	405	0,75	mc. 0,017
132104-101	● gris/gris	x1	10	530	220	405	0,75	mc. 0,017
132115-101	● bleu/azul	x1	10	530	220	405	0,75	mc. 0,017

17 genesis - panneau en plastique pour dossier à tapisser
genesis - tablero de plástico por tapizar

code	finishing	q.kit	q.pack	a	b	c	kg.x1	vol.x1
132103-102	● noir/negro	x1	10	425	140	355	0,674	mc. 0,004
132105-102	● blanc/blanco	x1	10	425	140	355	0,674	mc. 0,004
132104-102	● gris/gris	x1	10	425	140	355	0,674	mc. 0,004
132115-102	● bleu/azul	x1	10	425	140	355	0,674	mc. 0,004

18 genesis - structure d'accoudoirs en plastique
genesis - estructura reposabrazos de plástico

code	finishing	q.kit	q.pack	a	b	c	kg.x1	vol.x1
131703-100	● noir/negro	x1	5	620	345	365	1,00	mc. 0,0183
131705-100	● blanc/blanco	x1	5	620	345	365	1,00	mc. 0,0183
131704-100	● gris/gris	x1	5	620	345	365	1,00	mc. 0,0183
131715-100	● bleu/azul	x1	5	620	345	365	1,00	mc. 0,0183

03 genesis - siège en plastique coloré
genesis - asiento de plástico de color

code	finishing	q.kit	q.pack	a	b	c	kg.x1	vol.x1
132203-091	● noir/negro	x1	10	460	500	55	0,95	mc. 0,017
132205-091	● blanc/blanco	x1	10	460	500	55	0,95	mc. 0,017
132204-091	● gris/gris	x1	10	460	500	55	0,95	mc. 0,017
132215-091	● bleu/azul	x1	10	460	500	55	0,95	mc. 0,017

04 genesis - assise externe en plastique pour châssis 4 pieds et luge + entretoises en pvc
genesis - asiento inferior de plástico para estructura de 4 patas y patin + parachoques de cabeza redondeada en pvc

code	finishing	q.kit	q.pack	a	b	c	kg.x1	vol.x1
132203-092	● noir/negro	x1	10	505	495	50	0,75	mc. 0,017
132205-092	● blanc/blanco	x1	10	505	495	50	0,75	mc. 0,017
132204-092	● gris/gris	x1	10	505	495	50	0,75	mc. 0,017
132215-092	● bleu/blue	x1	10	505	495	50	0,75	mc. 0,017

06 genesis - sac des embouts rondes noires d.22
genesis - bolsa de puntas redondas d.22 negro

code	finishing	q.kit	q.pack
137003-073	● noir/negro	x4	290

07 genesis - paire des accroches latérales chromées mâle + femelle
genesis - pareja de ganchos laterales cromados macho + hembra

code	finishing	q.kit	kg.x1	vol.x1
113410-100	● chromé/cromado	x1	0,13	mc. 0,0004

genesi

4-legs with armrests/frame options

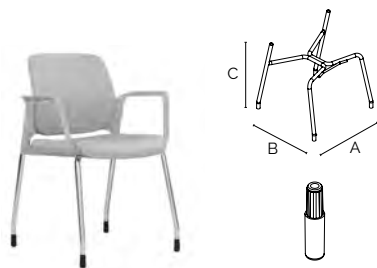

08 genesi - châssis 4 pieds pour roulettes et pieds hauts
genesi - estructura de 4 patas para ruedas y patas altas

code	finishing	q.kit	q.pack	a	b	c	kg.x1	vol.x1
110103-571	● noir/negro	x1	80	525	510	545	3.30	mc. 0.017
110105-571	● blanc/blanco	x1	80	525	510	545	3.30	mc. 0.017
110104-571	● gris/gris	x1	80	525	510	545	3.30	mc. 0.017
110110-571	● chromé/cromado	x1	80	525	510	545	3.30	mc. 0.017

09 genesi - pied haut (pour châssis pour roulettes)
genesi - pie alto (para estructura de ruedas)

code	finishing	q.kit
134303-064	● noir/negro	x4

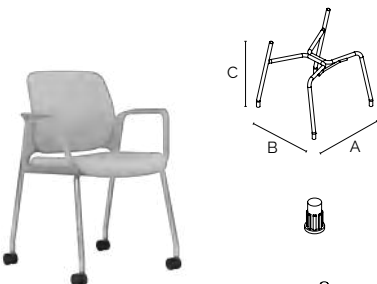

08 genesi - châssis 4 pieds pour roulettes et pieds hauts
genesi - estructura de 4 patas para ruedas y patas altas

code	finishing	q.kit	q.pack	a	b	c	kg.x1	vol.x1
110103-571	● noir/negro	x1	80	525	510	545	3.30	mc. 0.017
110105-571	● blanc/blanco	x1	80	525	510	545	3.30	mc. 0.017
110104-571	● gris/gris	x1	80	525	510	545	3.30	mc. 0.017
110110-571	● chromé/cromado	x1	80	525	510	545	3.30	mc. 0.017

10 genesi - réducteur rayé pour roulettes (pour châssis pour roulettes)
genesi - reductor rayado (para estructura de ruedas)

code	finishing	q.kit
134303-051	● noir/negro	x4

11 genesi - roulette double d.50 à desmopan avec goupille montée
genesi - doble rueda d.50 de desmopan con perno montado

code	finishing	q.kit	kg.x1
134403-003	● noir/negro	x5	0.05

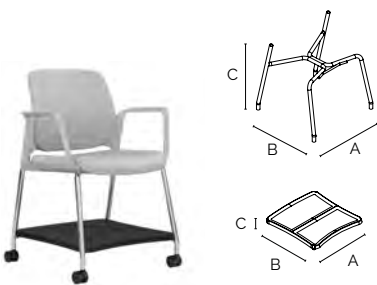

12 genesi - châssis 4 pieds pour roulettes et pieds hauts avec trous pour plateau de stockage
genesi - estructura de 4 patas con agujeros para cesto (para ruedas y patas altas)

code	finishing	q.kit	q.pack	a	b	c	kg.x1	vol.x1
110103-573	● noir/negro	x1	80	525	510	545	3.30	mc. 0.017
110105-573	● blanc/blanco	x1	80	525	510	545	3.30	mc. 0.017
110104-573	● gris/gris	x1	80	525	510	545	3.30	mc. 0.017
110110-573	● chromé/cromado	x1	80	525	510	545	3.30	mc. 0.017

13 genesi - plateau de stockage
genesi - bandeja portaobjetos

code	finishing	q.kit	q.pack	a	b	c
134003-225	● noir/negro	x1	10	512	530	40

14 genesi - vis autotaraudeuse TC+ 5,5x19 galvanisée blanche (pour plateau de stockage)
genesi - tornillo autorroscante TC+ 5,5x19 galvanizado blanco (para bandeja)

code	finishing	q.kit
117811-180	● galvanisé/galvanizado	x4

4-legs with armrests/backrest options

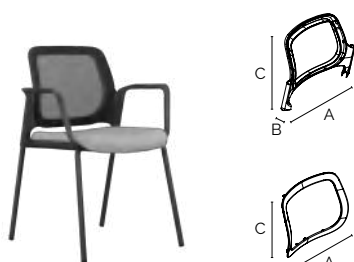

15 genesi - châssis porteur de dossier en plastique
genesi - estructura de respaldo de plástico

code	finishing	q.kit	q.pack	a	b	c	kg.x1	vol.x1
132103-101	● noir/negro	x1	10	530	220	405	0.75	mc. 0.017
132105-101	● blanc/blanco	x1	10	530	220	405	0.75	mc. 0.017
132104-101	● gris/gris	x1	10	530	220	405	0.75	mc. 0.017
132115-101	● bleu/azul	x1	10	530	220	405	0.75	mc. 0.017

16 genesi - cadre de dossier en plastique pour treillis
genesi - marco de respaldo de plástico para red

code	finishing	q.kit	q.pack	a	b	c	kg.x1	vol.x1
132103-103	● noir/negro	x1	10	425	140	355	0.30	mc. 0.004
132105-103	● blanc/blanco	x1	10	425	140	355	0.30	mc. 0.004
132104-103	● gris/gris	x1	10	425	140	355	0.30	mc. 0.004
132115-103	● bleu/azul	x1	10	425	140	355	0.30	mc. 0.004

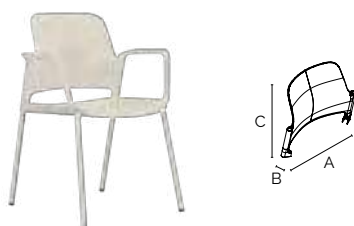

02 genesi - dossier en plastique coloré
genesi - respaldo a vista de plástico de color

code	finishing	q.kit	q.pack	a	b	c	kg.x1	vol.x1
132103-100	● noir/negro	x1	10	530	205	395	1.05	mc. 0.017
132105-100	● blanc/blanco	x1	10	530	205	395	1.05	mc. 0.017
132104-100	● gris/gris	x1	10	530	205	395	1.05	mc. 0.017
132115-100	● bleu/azul	x1	10	530	205	395	1.05	mc. 0.017

genesis

4-legs with writing tablet

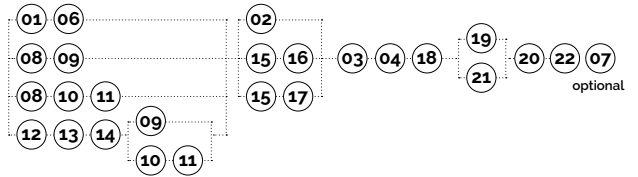

plastic colours

- noir/negro
- blanc/blanco
- gris/gris
- bleu/azul

main component sizes

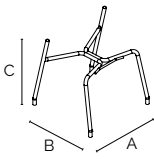

12

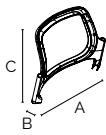

15

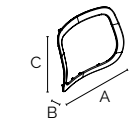

16

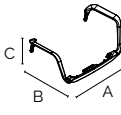

18

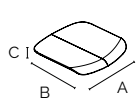

03

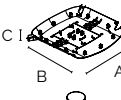

04



19

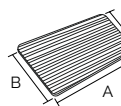

22

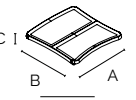

13

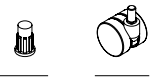

10



11

12 genesis - châssis 4 pieds pour roulettes et pieds hauts avec trous pour plateau de stockage
genesis - estructura de 4 patas con agujeros para cesto (para ruedas y patas altas)

code	finishing	q.kit	q.pack	a	b	c	kg.x1	vol.x1
110103-573	● noir/negro	x1	80	525	510	545	3,30	mc. 0.017
110105-573	● blanc/blanco	x1	80	525	510	545	3,30	mc. 0.017
110104-573	● gris/gris	x1	80	525	510	545	3,30	mc. 0.017
110110-573	● chromé/cromado	x1	80	525	510	545	3,30	mc. 0.017

15 genesis - châssis porteur de dossier en plastique
genesis - estructura de respaldo de plástico

code	finishing	q.kit	q.pack	a	b	c	kg.x1	vol.x1
132103-101	● noir/negro	x1	10	530	220	405	0,75	mc. 0.017
132105-101	● blanc/blanco	x1	10	530	220	405	0,75	mc. 0.017
132104-101	● gris/gris	x1	10	530	220	405	0,75	mc. 0.017
132115-101	● bleu/azul	x1	10	530	220	405	0,75	mc. 0.017

16 genesis - cadre de dossier en plastique pour treillis
genesis - marco de respaldo de plástico para red

code	finishing	q.kit	q.pack	a	b	c	kg.x1	vol.x1
132103-103	● noir/negro	x1	10	425	140	355	0,30	mc. 0.004
132105-103	● blanc/blanco	x1	10	425	140	355	0,30	mc. 0.004
132104-103	● gris/gris	x1	10	425	140	355	0,30	mc. 0.004
132115-103	● bleu/azul	x1	10	425	140	355	0,30	mc. 0.004

18 genesis - structure d'accoudoirs en plastique
genesis - estructura reposabrazos de plástico

code	finishing	q.kit	q.pack	a	b	c	kg.x1	vol.x1
131703-100	● noir/negro	x1	5	620	345	365	1,00	mc. 0.0183
131705-100	● blanc/blanco	x1	5	620	345	365	1,00	mc. 0.0183
131704-100	● gris/gris	x1	5	620	345	365	1,00	mc. 0.0183
131715-100	● bleu/azul	x1	5	620	345	365	1,00	mc. 0.0183

19 genesis - support droit pour tablette
genesis - soporte derecho para tableta

code	finishing	q.kit	q.pack
131703-101	● noir/negro	x1	/
131705-101	● blanc/blanco	x1	/
131704-101	● gris/gris	x1	/
131715-101	● bleu/azul	x1	/

22 tl02.cfd - tablette droite en bois avec pré-perçages peinte en hêtre
tl02.cfd - tableta derecha de madera con agujeros pintada haya

code	finishing	q.kit	q.pack	a	b	c	kg.x1	vol.x1
120307-021	● hêtre/haya	x1	10	342	245	196	0,65	mc. 0.009

13 genesis - plateau de stockage
genesis - bandeja portaobjetos

code	finishing	q.kit	q.pack	a	b	c
134003-225	● noir/negro	x1	10	512	530	40

14 genesis - vis autotaraudeuse TC+ 5,5x19 galvanisée blanche (pour plateau de stockage)
genesis - tornillo autorroscante TC+ 5,5x19 galvanizado blanco (para bandeja)

code	finishing	q.kit
117811-180	● galvanisé/galvanizado	x4

10 genesis - réducteur rayé pour roulettes (pour châssis pour roulettes)
genesis - reductor rayado (para estructura de ruedas)

code	finishing	q.kit
134303-051	● noir/negro	x4

11 genesis - roulette double d.50 à desmopan avec goupille montée
genesis - doble rueda d.50 de desmopan con perno montado

code	finishing	q.kit	kg.x1
134403-003	● noir/negro	x5	0,05

for the components below,
see previous pages

03 04 07

genesis

4-legs with writing tablet/frame options

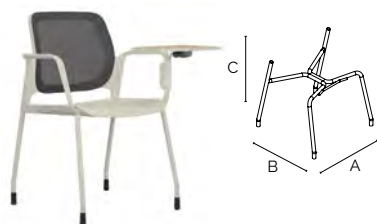

08 genesis - châssis 4 pieds pour roulettes et pieds hauts
genesis - estructura de 4 patas para ruedas y patas altas

code	finishing	q.kit	q.pack	a	b	c	kg.x1	vol.x1
110103-571	● noir/negro	x1	80	525	510	545	3,30	mc. 0,017
110105-571	● blanc/blanco	x1	80	525	510	545	3,30	mc. 0,017
110104-571	● gris/gris	x1	80	525	510	545	3,30	mc. 0,017
110110-571	● chromé/cromado	x1	80	525	510	545	3,30	mc. 0,017

and · **09**



08 genesis - châssis 4 pieds pour roulettes et pieds hauts
genesis - estructura de 4 patas para ruedas y patas altas

code	finishing	q.kit	q.pack	a	b	c	kg.x1	vol.x1
110103-571	● noir/negro	x1	80	525	510	545	3,30	mc. 0,017
110105-571	● blanc/blanco	x1	80	525	510	545	3,30	mc. 0,017
110104-571	● gris/gris	x1	80	525	510	545	3,30	mc. 0,017
110110-571	● chromé/cromado	x1	80	525	510	545	3,30	mc. 0,017

and · **10** · **11**

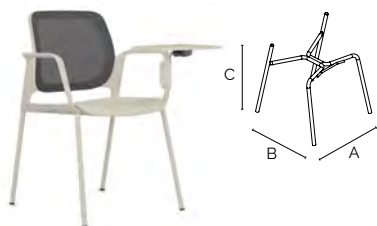

01 genesis - châssis 4 pieds ø.22 sans embouts
genesis - junta de 4 patas ø.22 sin tapones

code	finishing	q.kit	q.pack	a	b	c	kg.x1	vol.x1
110103-564	● noir/negro	x1	72	545	555	605	3,92	mc. 0,08
110105-564	● blanc/blanco	x1	72	545	555	605	3,92	mc. 0,08
110104-564	● gris/gris	x1	72	545	555	605	3,92	mc. 0,08
110110-564	● chromé/cromado	x1	72	545	555	605	3,92	mc. 0,08

and · **06**

writing tablet options



21 genesis - support gauche pour tablette
genesis - soporte izquierdo para tableta

code	finishing	q.kit	q.pack
131703-102	● noir/negro	x1	/
131705-102	● blanc/blanco	x1	/
131704-102	● gris/gris	x1	/
131715-102	● bleu/azul	x1	/

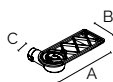

20 genesis - joint de panique SPTA pour la fixation de la tablette
genesis - junta de antipánico SPTA para la fijación de tabletas

code	finishing		q.kit	q.pack	a	b	c	kg.x1	vol.x1
111701-900	● aluminium/aluminio	droite/derecha	x1	10	180	66	15x15	0,365	mc. 0,001
111701-901	● aluminium/aluminio	gauche/izquierda	x1	10	180	66	15x15	0,365	mc. 0,001

TLT tablet TLT2 tablet TLT3 tablet BEAN tablet TL02 tablet SPT2 mechanism tablet SPTA mechanism antipanic



for writing tablet options, see page 404/405

4-legs with writing tablet/backrest options



15 genesis - châssis porteur de dossier en plastique
genesis - estructura de respaldo de plástico

code	finishing	q.kit	q.pack	a	b	c	kg.x1	vol.x1
132103-101	● noir/negro	x1	10	530	220	405	0,75	mc. 0,017
132105-101	● blanc/blanco	x1	10	530	220	405	0,75	mc. 0,017
132104-101	● gris/gris	x1	10	530	220	405	0,75	mc. 0,017
132115-101	● bleu/azul	x1	10	530	220	405	0,75	mc. 0,017

and · **17**



02 genesis - dossier en plastique coloré
genesis - respaldo a vista de plástico de color

code	finishing	q.kit	q.pack	a	b	c	kg.x1	vol.x1
132103-100	● noir/negro	x1	10	530	205	395	1,05	mc. 0,017
132105-100	● blanc/blanco	x1	10	530	205	395	1,05	mc. 0,017
132104-100	● gris/gris	x1	10	530	205	395	1,05	mc. 0,017
132115-100	● bleu/azul	x1	10	530	205	395	1,05	mc. 0,017

genesis

cantilever

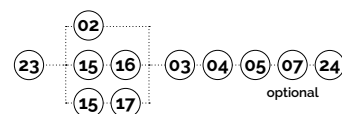
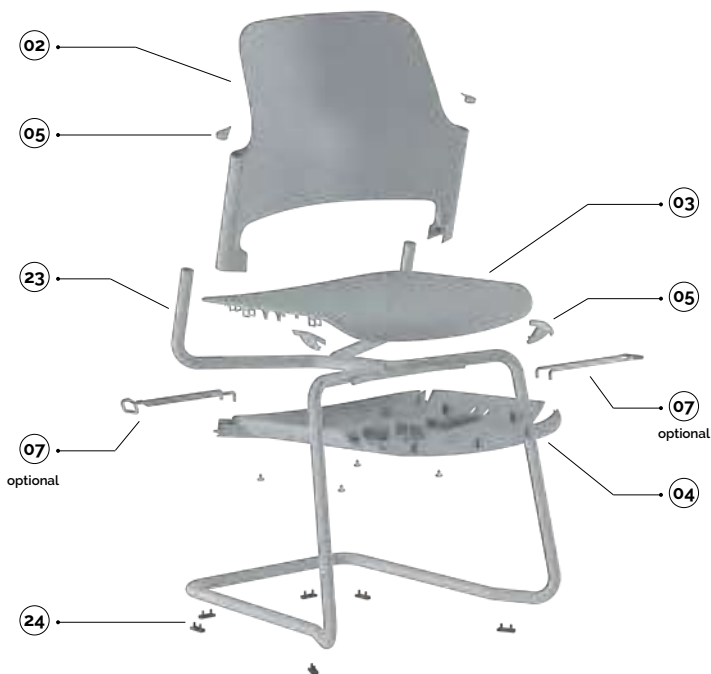

plastic colours

- noir/negro
- blanc/blanco
- gris/gris
- bleu/azul

main component sizes

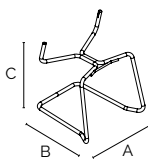

23

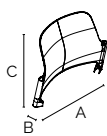

02

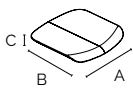

03

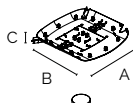

04

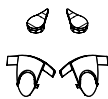

05



24



07

23 genesis - luge en tube asform d.22 sans embouts genesis - base de patin tubular asform d.22 sin tapones

code	finishing	q.kit	q.pack	a	b	c	kg.x1	vol.x1
110503-594	● noir/negro	x1	50	530	515	605	4.60	mc. 0.06
110505-594	● blanc/blanco	x1	50	530	515	605	4.60	mc. 0.06
110504-594	● gris/gris	x1	50	530	515	605	4.60	mc. 0.06
110510-594	● chromé/cromado	x1	50	530	515	605	4.60	mc. 0.06

02 genesis - dossier en plastique coloré genesis - respaldo a vista de plástico de color

code	finishing	q.kit	q.pack	a	b	c	kg.x1	vol.x1
132103-100	● noir/negro	x1	10	530	205	395	1.05	mc. 0.017
132105-100	● blanc/blanco	x1	10	530	205	395	1.05	mc. 0.017
132104-100	● gris/gris	x1	10	530	205	395	1.05	mc. 0.017
132115-100	● bleu/azul	x1	10	530	205	395	1.05	mc. 0.017

03 genesis - siège en plastique coloré genesis - asiento de plástico de color

code	finishing	q.kit	q.pack	a	b	c	kg.x1	vol.x1
132203-091	● noir/negro	x1	10	460	500	55	0.95	mc. 0.017
132205-091	● blanc/blanco	x1	10	460	500	55	0.95	mc. 0.017
132204-091	● gris/gris	x1	10	460	500	55	0.95	mc. 0.017
132215-091	● bleu/azul	x1	10	460	500	55	0.95	mc. 0.017

04 genesis - assise externe en plastique pour châssis 4 pieds et luge + entretoises en pvc genesis - asiento inferior de plástico para estructura de 4 patas y patin + parachoques de cabeza redondeada en pvc

code	finishing	q.kit	q.pack	a	b	c	kg.x1	vol.x1
132203-092	● noir/negro	x1	10	505	495	50	0.75	mc. 0.017
132205-092	● blanc/blanco	x1	10	505	495	50	0.75	mc. 0.017
132204-092	● gris/gris	x1	10	505	495	50	0.75	mc. 0.017
132215-092	● bleu/azul	x1	10	505	495	50	0.75	mc. 0.017

05 genesis - embouts pour dossier sans accoudoirs + paire d'accessoires pour siège sans accoudoirs genesis - tapones de respaldo sin reposabrazos + bolsa de accesorios para asiento sin reposabrazos

code	finishing	q.kit	q.pack	kg.x1
131703-104	● noir/negro	x1	10	0.015
131705-104	● blanc/blanco	x1	10	0.015
131704-104	● gris/gris	x1	10	0.015
131715-104	● bleu/azul	x1	10	0.015

24 genesis - pied à deux broches en polyéthylène noir genesis - abrazadera dos polos de polietileno negro

code	finishing	q.kit
134003-003	● noir/negro	x6

07 genesis - paire des accroches latérales chromés mâle + femelle genesis - pareja de ganchos laterales cromados macho + hembra

code	finishing	q.kit	kg.x1	vol.x1
113410-100	● chromé/cromado	x1	0.13	mc. 0.0004

genesis

cantilever/backrest options

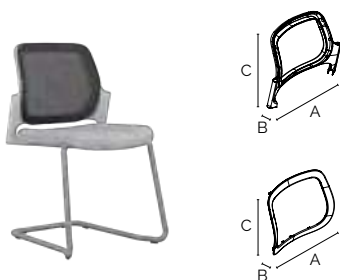

15 genesis - châssis porteur de dossier en plastique genesis - estructura de respaldo de plástico

code	finishing	q.kit	q.pack	a	b	c	kg.x1	vol.x1
132103-101	● noir/negro	x1	10	530	220	405	0,75	mc. 0,017
132105-101	● blanc/blanco	x1	10	530	220	405	0,75	mc. 0,017
132104-101	● gris/gris	x1	10	530	220	405	0,75	mc. 0,017
132115-101	● bleu/azul	x1	10	530	220	405	0,75	mc. 0,017

16 genesis - cadre de dossier en plastique pour treillis genesis - marco de respaldo de plástico para red

code	finishing	q.kit	q.pack	a	b	c	kg.x1	vol.x1
132103-103	● noir/negro	x1	10	425	140	355	0,30	mc. 0,004
132105-103	● blanc/blanco	x1	10	425	140	355	0,30	mc. 0,004
132104-103	● gris/gris	x1	10	425	140	355	0,30	mc. 0,004
132115-103	● bleu/azul	x1	10	425	140	355	0,30	mc. 0,004

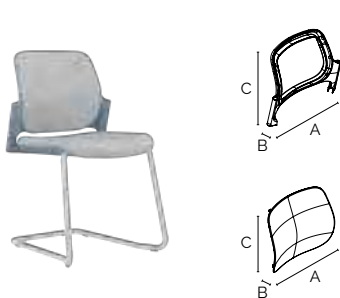

15 genesis - châssis porteur de dossier en plastique genesis - estructura de respaldo de plástico

code	finishing	q.kit	q.pack	a	b	c	kg.x1	vol.x1
132103-101	● noir/negro	x1	10	530	220	405	0,75	mc. 0,017
132105-101	● blanc/blanco	x1	10	530	220	405	0,75	mc. 0,017
132104-101	● gris/gris	x1	10	530	220	405	0,75	mc. 0,017
132115-101	● bleu/azul	x1	10	530	220	405	0,75	mc. 0,017

17 genesis - panneau en plastique pour dossier à tapisser genesis - tablero de plástico por tapizar

code	finishing	q.kit	q.pack	a	b	c	kg.x1	vol.x1
132103-102	● noir/negro	x1	10	425	140	355	0,674	mc. 0,004
132105-102	● blanc/blanco	x1	10	425	140	355	0,674	mc. 0,004
132104-102	● gris/gris	x1	10	425	140	355	0,674	mc. 0,004
132115-102	● bleu/azul	x1	10	425	140	355	0,674	mc. 0,004

genesis

cantilever with armrests

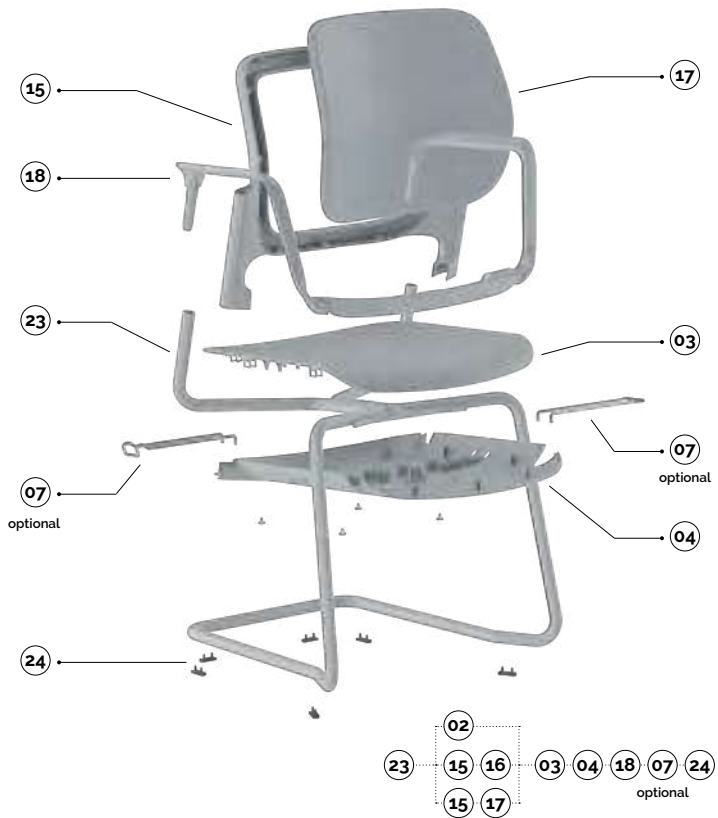

plastic colours

- noir/negro
- blanc/blanco
- gris/gris
- bleu/azul

main component sizes

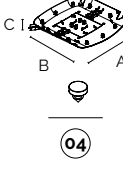
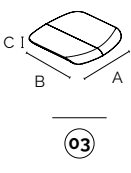
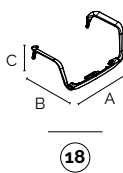
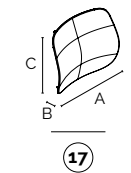
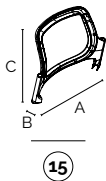
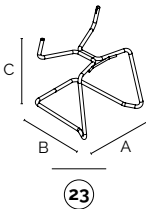

23 genesis - luge en tube asform d.22 sans embouts genesis - base de patin tubular asform d.22 sin tapones

code	finishing	q.kit	q.pack	a	b	c	kg.x1	vol.x1
110503-594	● noir/negro	x1	50	530	515	605	4,60	mc. 0,06
110505-594	● blanc/blanco	x1	50	530	515	605	4,60	mc. 0,06
110504-594	● gris/gris	x1	50	530	515	605	4,60	mc. 0,06
110510-594	● chromé/cromado	x1	50	530	515	605	4,60	mc. 0,06

15 genesis - châssis porteur de dossier en plastique genesis - estructura de respaldo de plástico

code	finishing	q.kit	q.pack	a	b	c	kg.x1	vol.x1
132103-101	● noir/negro	x1	10	530	220	405	0,75	mc. 0,017
132105-101	● blanc/blanco	x1	10	530	220	405	0,75	mc. 0,017
132104-101	● gris/gris	x1	10	530	220	405	0,75	mc. 0,017
132115-101	● bleu/azul	x1	10	530	220	405	0,75	mc. 0,017

17 genesis - panneau en plastique pour dossier à tapisser genesis - tablero de plástico por tapizar

code	finishing	q.kit	q.pack	a	b	c	kg.x1	vol.x1
132103-102	● noir/negro	x1	10	425	140	355	0,674	mc. 0,004
132105-102	● blanc/blanco	x1	10	425	140	355	0,674	mc. 0,004
132104-102	● gris/gris	x1	10	425	140	355	0,674	mc. 0,004
132115-102	● bleu/azul	x1	10	425	140	355	0,674	mc. 0,004

18 genesis - structure d'accoudoirs en plastique genesis - estructura reposabrazos de plástico

code	finishing	q.kit	q.pack	a	b	c	kg.x1	vol.x1
131703-100	● noir/negro	x1	5	620	345	365	1,00	mc. 0,0183
131705-100	● blanc/blanco	x1	5	620	345	365	1,00	mc. 0,0183
131704-100	● gris/gris	x1	5	620	345	365	1,00	mc. 0,0183
131715-100	● bleu/azul	x1	5	620	345	365	1,00	mc. 0,0183

03 genesis - siège en plastique coloré genesis - asiento de plástico de color

code	finishing	q.kit	q.pack	a	b	c	kg.x1	vol.x1
132203-091	● noir/negro	x1	10	460	500	55	0,95	mc. 0,017
132205-091	● blanc/blanco	x1	10	460	500	55	0,95	mc. 0,017
132204-091	● gris/gris	x1	10	460	500	55	0,95	mc. 0,017
132215-091	● bleu/azul	x1	10	460	500	55	0,95	mc. 0,017

04 genesis - assise externe en plastique pour châssis 4 pieds et luge + entretoises en pvc genesis - asiento inferior de plástico para estructura de 4 patas y patin + parachoques de cabeza redondeada en pvc

code	finishing	q.kit	q.pack	a	b	c	kg.x1	vol.x1
132203-092	● noir/negro	x1	10	505	495	50	0,75	mc. 0,017
132205-092	● blanc/blanco	x1	10	505	495	50	0,75	mc. 0,017
132204-092	● gris/gris	x1	10	505	495	50	0,75	mc. 0,017
132215-092	● bleu/azul	x1	10	505	495	50	0,75	mc. 0,017

24 genesis - pied à deux broches en polyéthylène noir genesis - abrazadera dos polos de polietileno negro

code	finishing	q.kit
134003-003	● noir/negro	x6

07 genesis - paire des accroches latérales chromées mâle + femelle genesis - pareja de ganchos laterales cromados macho + hembra

code	finishing	q.kit	kg.x1	vol.x1
113410-100	● chromé/cromado	x1	0,13	mc. 0,0004

genesis

cantilever with armrests/backrest options

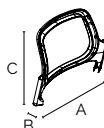

15 genesis - châssis porteur de dossier en plastique
genesis - estructura de respaldo de plástico

code	finishing	q.kit	q.pack	a	b	c	kg.x1	vol.x1
132103-101	● noir/negro	x1	10	530	220	405	0,75	mc. 0,017
132105-101	● blanc/blanco	x1	10	530	220	405	0,75	mc. 0,017
132104-101	● gris/gris	x1	10	530	220	405	0,75	mc. 0,017
132115-101	● bleu/azul	x1	10	530	220	405	0,75	mc. 0,017

16 genesis - cadre de dossier en plastique pour treillis
genesis - marco de respaldo de plástico para red

code	finishing	q.kit	q.pack	a	b	c	kg.x1	vol.x1
132103-103	● noir/negro	x1	10	425	140	355	0,30	mc. 0,004
132105-103	● blanc/blanco	x1	10	425	140	355	0,30	mc. 0,004
132104-103	● gris/gris	x1	10	425	140	355	0,30	mc. 0,004
132115-103	● bleu/azul	x1	10	425	140	355	0,30	mc. 0,004

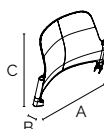

02 genesis - dossier en plastique coloré
genesis - respaldo a vista de plástico de color

code	finishing	q.kit	q.pack	a	b	c	kg.x1	vol.x1
132103-100	● noir/negro	x1	10	530	205	395	1,05	mc. 0,017
132105-100	● blanc/blanco	x1	10	530	205	395	1,05	mc. 0,017
132104-100	● gris/gris	x1	10	530	205	395	1,05	mc. 0,017
132115-100	● bleu/azul	x1	10	530	205	395	1,05	mc. 0,017

genesis

cantilever with writing tablet

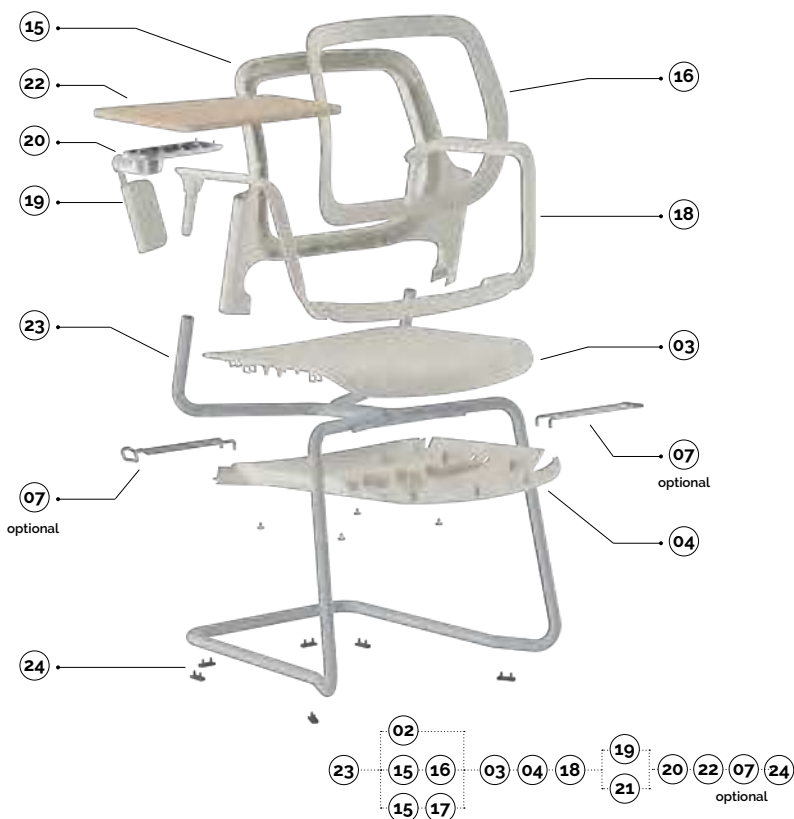

plastic colours

- noir/negro
- blanc/blanco
- gris/gris
- bleu/azul

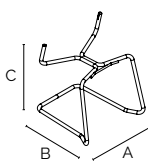

23

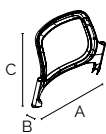

15

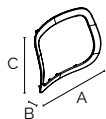

16

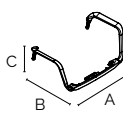

18

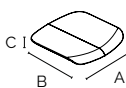

03

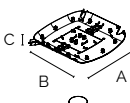

04



19

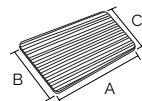

22



24

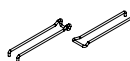

07

main component sizes

23 genesis - luge en tube asform d.22 sans embouts
genesis - base de patin tubular asform d.22 sin tapones

code	finishing	q.kit	q.pack	a	b	c	kg.x1	vol.x1
110503-594	● noir/negro	x1	50	530	515	605	4,60	mc. 0,06
110505-594	● blanc/blanco	x1	50	530	515	605	4,60	mc. 0,06
110504-594	● gris/gris	x1	50	530	515	605	4,60	mc. 0,06
110510-594	● chromé/cromado	x1	50	530	515	605	4,60	mc. 0,06

15 genesis - châssis porteur de dossier en plastique
genesis - estructura de respaldo de plástico

code	finishing	q.kit	q.pack	a	b	c	kg.x1	vol.x1
132103-101	● noir/negro	x1	10	530	220	405	0,75	mc. 0,017
132105-101	● blanc/blanco	x1	10	530	220	405	0,75	mc. 0,017
132104-101	● gris/gris	x1	10	530	220	405	0,75	mc. 0,017
132115-101	● bleu/azul	x1	10	530	220	405	0,75	mc. 0,017

16 genesis - cadre de dossier en plastique pour treillis
genesis - marco de respaldo de plástico para red

code	finishing	q.kit	q.pack	a	b	c	kg.x1	vol.x1
132103-103	● noir/negro	x1	10	425	140	355	0,30	mc. 0,004
132105-103	● blanc/blanco	x1	10	425	140	355	0,30	mc. 0,004
132104-103	● gris/gris	x1	10	425	140	355	0,30	mc. 0,004
132115-103	● bleu/azul	x1	10	425	140	355	0,30	mc. 0,004

18 genesis - structure d'accoudoirs en plastique
genesis - estructura reposabrazos de plástico

code	finishing	q.kit	q.pack	a	b	c	kg.x1	vol.x1
131703-100	● noir/negro	x1	5	620	345	365	1,00	mc. 0,0183
131705-100	● blanc/blanco	x1	5	620	345	365	1,00	mc. 0,0183
131704-100	● gris/gris	x1	5	620	345	365	1,00	mc. 0,0183
131715-100	● bleu/azul	x1	5	620	345	365	1,00	mc. 0,0183

19 genesis - support droit pour tablette
genesis - soporte derecho para tableta

code	finishing	q.kit	q.pack
131703-101	● noir/negro	x1	/
131705-101	● blanc/blanco	x1	/
131704-101	● gris/gris	x1	/
131715-101	● bleu/azul	x1	/

22 tl02.cfd - tablette droite en bois avec pré-perçages peinte en hêtre
tl02.cfd - tableta derecha de madera con agujeros pintada haya

code	finishing	q.kit	q.pack	a	b	c	kg.x1	vol.x1
120307-021	● hêtre/haya	x1	10	342	245	196	0,65	mc. 0,009

24 genesis - pied à deux broches en polyéthylène noir
genesis - abrazadera dos polos de polietileno negro

code	finishing	q.kit
134003-003	● noir/negro	x6

07 genesis - paire des accroches latérales chromés mâle + femelle
genesis - pareja de ganchos laterales cromados macho + hembra

code	finishing	q.kit	kg.x1	vol.x1
113410-100	● chromé/cromado	x1	0,13	mc. 0,0004

for the components below,
see previous pages

03 04

genesis

cantilever with writing tablet/backrest options

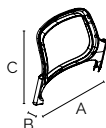

15 genesis - châssis porteur de dossier en plastique
genesis - estructura de respaldo de plástico

code	finishing	q.kit	q.pack	a	b	c	kg.x1	vol.x1
132103-101	● noir/negro	x1	10	530	220	405	0,75	mc. 0,017
132105-101	● blanc/blanco	x1	10	530	220	405	0,75	mc. 0,017
132104-101	● gris/gris	x1	10	530	220	405	0,75	mc. 0,017
132115-101	● bleu/azul	x1	10	530	220	405	0,75	mc. 0,017

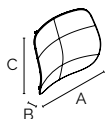

17 genesis - panneau en plastique pour dossier à tapisser
genesis - tablero de plástico por tapizar

code	finishing	q.kit	q.pack	a	b	c	kg.x1	vol.x1
132103-102	● noir/negro	x1	10	425	140	355	0,674	mc. 0,004
132105-102	● blanc/blanco	x1	10	425	140	355	0,674	mc. 0,004
132104-102	● gris/gris	x1	10	425	140	355	0,674	mc. 0,004
132115-102	● bleu/azul	x1	10	425	140	355	0,674	mc. 0,004

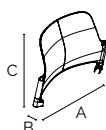

20 genesis - dossier en plastique coloré
genesis - respaldo a vista de plástico de color

code	finishing	q.kit	q.pack	a	b	c	kg.x1	vol.x1
132103-100	● noir/negro	x1	10	530	205	395	1,05	mc. 0,017
132105-100	● blanc/blanco	x1	10	530	205	395	1,05	mc. 0,017
132104-100	● gris/gris	x1	10	530	205	395	1,05	mc. 0,017
132115-100	● bleu/azul	x1	10	530	205	395	1,05	mc. 0,017

writing tablet options



21 genesis - support gauche pour tablette
genesis - soporte izquierdo para tableta

code	finishing	q.kit	q.pack
131703-102	● noir/negro	x1	/
131705-102	● blanc/blanco	x1	/
131704-102	● gris/gris	x1	/
131715-102	● bleu/azul	x1	/

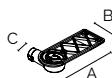

20 genesis - joint de panique SPTA pour la fixation de la tablette
genesis - junta de antipánico SPTA para la fijación de tabletas

code	finishing		q.kit	q.pack	a	b	c	kg.x1	vol.x1
111701-900	● aluminium/aluminio	droite/derecha	x1	10	180	66	15x15	0,365	mc. 0,001
111701-901	● aluminium/aluminio	gauche/izquierda	x1	10	180	66	15x15	0,365	mc. 0,001

TLT
tablet

TLT2
tablet

TLT3
tablet

BEAN
tablet

TL02
tablet

SPT2
mechanism tablet

SPTA
mechanism antipanic



for writing tablet options, see page 404/405

genesis

swivel

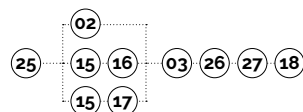

plastic colours

- noir/negro
- blanc/blanco
- gris/gris
- bleu/azul

main component sizes

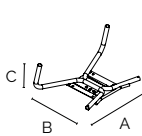

25

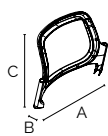

15

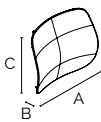

17

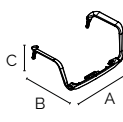

18

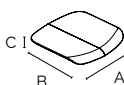

03

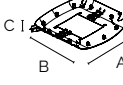

26



27

25 genesis - châssis pivotant à gaz
genesis - estructura giratoria accionada por gas

code	finishing	q.kit	q.pack	a	b	c	kg.x1	vol.x1
110903-297	● noir/negro	x1	120	525	350	200	2,55	mc. 0,00704

15 genesis - châssis porteur de dossier en plastique
genesis - estructura de respaldo de plástico

code	finishing	q.kit	q.pack	a	b	c	kg.x1	vol.x1
132103-101	● noir/negro	x1	10	530	220	405	0,75	mc. 0,017
132105-101	● blanc/blanco	x1	10	530	220	405	0,75	mc. 0,017
132104-101	● gris/gris	x1	10	530	220	405	0,75	mc. 0,017
132115-101	● bleu/azul	x1	10	530	220	405	0,75	mc. 0,017

17 genesis - panneau en plastique pour dossier à tapisser
genesis - tablero de plástico por tapizar

code	finishing	q.kit	q.pack	a	b	c	kg.x1	vol.x1
132103-102	● noir/negro	x1	10	425	140	355	0,674	mc. 0,004
132105-102	● blanc/blanco	x1	10	425	140	355	0,674	mc. 0,004
132104-102	● gris/gris	x1	10	425	140	355	0,674	mc. 0,004
132115-102	● bleu/azul	x1	10	425	140	355	0,674	mc. 0,004

18 genesis - structure d'accoudoirs en plastique
genesis - estructura reposabrazos de plástico

code	finishing	q.kit	q.pack	a	b	c	kg.x1	vol.x1
131703-100	● noir/negro	x1	5	620	345	365	1,00	mc. 0,0183
131705-100	● blanc/blanco	x1	5	620	345	365	1,00	mc. 0,0183
131704-100	● gris/gris	x1	5	620	345	365	1,00	mc. 0,0183
131715-100	● bleu/azul	x1	5	620	345	365	1,00	mc. 0,0183

03 genesis - siège en plastique coloré
genesis - asiento de plástico de color

code	finishing	q.kit	q.pack	a	b	c	kg.x1	vol.x1
132203-091	● noir/negro	x1	10	460	500	55	0,95	mc. 0,017
132205-091	● blanc/blanco	x1	10	460	500	55	0,95	mc. 0,017
132204-091	● gris/gris	x1	10	460	500	55	0,95	mc. 0,017
132215-091	● bleu/azul	x1	10	460	500	55	0,95	mc. 0,017

26 genesis - assise externe en plastique pour châssis pivotant et banquette
genesis - asiento inferior de plástico para estructura giratoria y banco

code	finishing	q.kit	q.pack	a	b	c	kg.x1	vol.x1
132203-094	● noir/negro	x1	10	505	495	50	0,62	mc. 0,017
132205-094	● blanc/blanco	x1	10	505	495	50	0,62	mc. 0,017
132204-094	● gris/gris	x1	10	505	495	50	0,62	mc. 0,017
132215-094	● bleu/azul	x1	10	505	495	50	0,62	mc. 0,017

27 genesis - paire des embouts pour structure pivotante et pour banquette avec accoudoirs + vis
genesis - pareja de tapones para giratorio y banco por versión con reposabrazos + tornillos

code	finishing	q.kit	q.pack	kg.x1
131703-103	● noir/negro	x1	10	0,04
131705-103	● blanc/blanco	x1	10	0,04
131704-103	● gris/gris	x1	10	0,04
131715-103	● bleu/azul	x1	10	0,04

genesis

swivel/backrest options

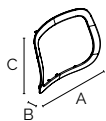
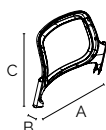

15 genesis - châssis porteur de dossier en plastique
genesis - estructura de respaldo de plástico

code	finishing	q.kit	q.pack	a	b	c	kg.x1	vol.x1
132103-101	● noir/negro	x1	10	530	220	405	0,75	mc. 0.017
132105-101	● blanc/blanco	x1	10	530	220	405	0,75	mc. 0.017
132104-101	● gris/gris	x1	10	530	220	405	0,75	mc. 0.017
132115-101	● bleu/azul	x1	10	530	220	405	0,75	mc. 0.017

16 genesis - cadre de dossier en plastique pour treillis
genesis - marco de respaldo de plástico para red

code	finishing	q.kit	q.pack	a	b	c	kg.x1	vol.x1
132103-103	● noir/negro	x1	10	425	140	355	0,30	mc. 0.004
132105-103	● blanc/blanco	x1	10	425	140	355	0,30	mc. 0.004
132104-103	● gris/gris	x1	10	425	140	355	0,30	mc. 0.004
132115-103	● bleu/azul	x1	10	425	140	355	0,30	mc. 0.004

and **18**

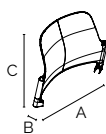

02 genesis - dossier en plastique coloré
genesis - respaldo a vista de plástico de color

code	finishing	q.kit	q.pack	a	b	c	kg.x1	vol.x1
132103-100	● noir/negro	x1	10	530	205	395	1,05	mc. 0.017
132105-100	● blanc/blanco	x1	10	530	205	395	1,05	mc. 0.017
132104-100	● gris/gris	x1	10	530	205	395	1,05	mc. 0.017
132115-100	● bleu/azul	x1	10	530	205	395	1,05	mc. 0.017

swivel/kit components

without armrests

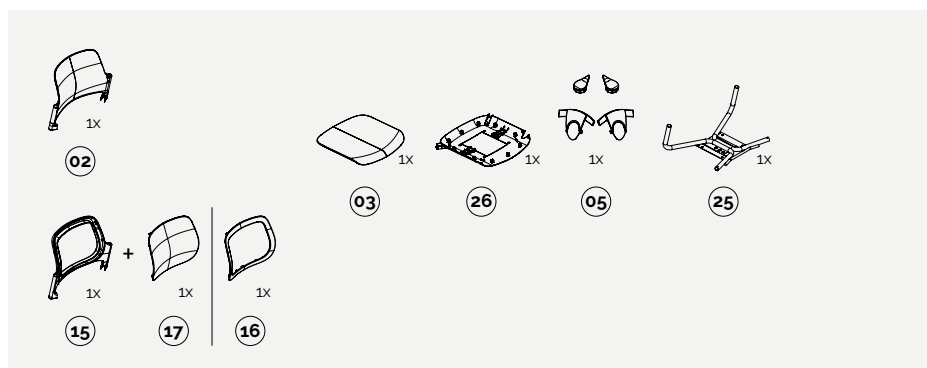
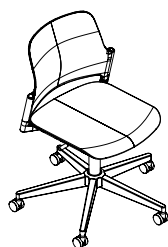

with armrests

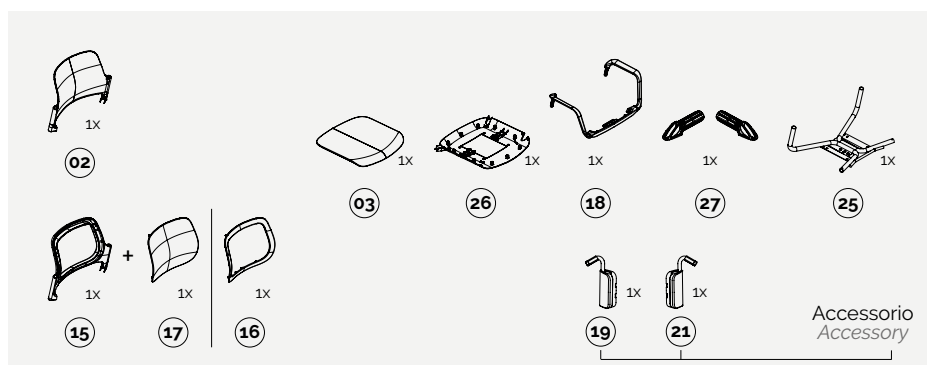
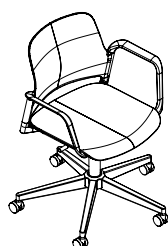

genesis

bench

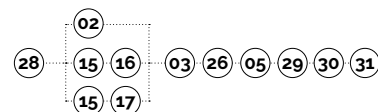

plastic colours

- noir/negro
- blanc/blanco
- gris/gris
- bleu/azul

main component sizes

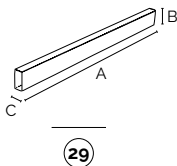
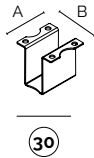
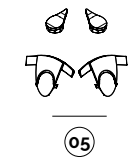
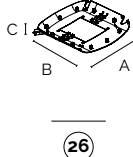
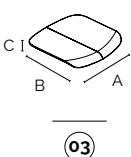
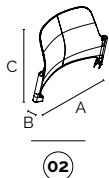
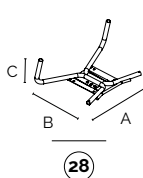

28 genesis - châssis pour banquette genesis - estructura de banco

code	finishing	q.kit	q.pack	a	b	c	kg.x1	vol.x1
110703-607	● noir/negro	x1	120	525	350	200	2,55	mc. 0.00704

02 genesis - dossier en plastique coloré genesis - respaldo a vista de plástico de color

code	finishing	q.kit	q.pack	a	b	c	kg.x1	vol.x1
132103-100	● noir/negro	x1	10	530	205	395	1,05	mc. 0.017
132105-100	● blanc/blanco	x1	10	530	205	395	1,05	mc. 0.017
132104-100	● gris/gris	x1	10	530	205	395	1,05	mc. 0.017
132115-100	● bleu/azul	x1	10	530	205	395	1,05	mc. 0.017

03 genesis - siège en plastique coloré genesis - asiento de plástico de color

code	finishing	q.kit	q.pack	a	b	c	kg.x1	vol.x1
132203-091	● noir/negro	x1	10	460	500	55	0,95	mc. 0.017
132205-091	● blanc/blanco	x1	10	460	500	55	0,95	mc. 0.017
132204-091	● gris/gris	x1	10	460	500	55	0,95	mc. 0.017
132215-091	● bleu/azul	x1	10	460	500	55	0,95	mc. 0.017

26 genesis - assise externe en plastique pour châssis pivotant et banquette genesis - asiento inferior de plástico para estructura giratoria y banco

code	finishing	q.kit	q.pack	a	b	c	kg.x1	vol.x1
132203-094	● noir/negro	x1	10	505	495	50	0,62	mc. 0.017
132205-094	● blanc/blanco	x1	10	505	495	50	0,62	mc. 0.017
132204-094	● gris/gris	x1	10	505	495	50	0,62	mc. 0.017
132215-094	● bleu/azul	x1	10	505	495	50	0,62	mc. 0.017

05 genesis - embouts pour dossier sans accoudoirs + paire d'accessoires pour siège sans accoudoirs genesis - tapones de respaldo sin reposabrazos + bolsa de accesorios para asiento sin reposabrazos

code	finishing	q.kit	q.pack	kg.x1
131703-104	● noir/negro	x1	10	0,015
131705-104	● blanc/blanco	x1	10	0,015
131704-104	● gris/gris	x1	10	0,015
131715-104	● bleu/azul	x1	10	0,015

29 genesis - goT(3) poutre de banquette 80x40 genesis - goT(3) viga para banco 80x40

code	finishing	q.kit	q.pack	a	b	c	kg.x1	vol.x1	
110703-190	● noir/negro	2 places/2 asientos	x1	1	1160	80	40	3,20	mc. 0.0045
110704-190	● gris/gris	2 places/2 asientos	x1	1	1160	80	40	3,20	mc. 0.0045
110703-191	● noir/negro	3 places/3 asientos	x1	1	1710	80	40	4,71	mc. 0.005
110704-191	● gris/gris	3 places/3 asientos	x1	1	1710	80	40	4,71	mc. 0.005
110703-192	● noir/negro	4 places/4 asientos	x1	1	2260	80	40	6,22	mc. 0.0085
110704-192	● gris/gris	4 places/4 asientos	x1	1	2260	80	40	6,22	mc. 0.0085
110703-193	● noir/negro	5 places/5 asientos	x1	1	2800	80	40	7,72	mc. 0.01
110704-197	● gris/gris	5 places/5 asientos	x1	1	2800	80	40	7,72	mc. 0.01

30 genesis - support en U pour fixation à la poutre genesis - omega debajo de la viga

code	finishing	q.kit	q.pack	a	b	kg.x1	vol.x1
110703-007	● noir/negro	x1	50	55	65	0,60	mc. 0.0005

31 genesis - paquet de vis à tête cylindrique et à six pans creux M8x12 genesis - bolsa de tornillos de cabeza cilíndrica y hexagonal M8x12

code	finishing	q.kit	q.pack
117003-070	● noir/negro	x1	200

for the bench components, see page 417

genesis

bench/backrest options

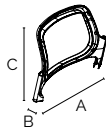

15 genesis - châssis porteur de dossier en plastique genesis - estructura de respaldo de plástico

code	finishing	q.kit	q.pack	a	b	c	kg.x1	vol.x1
132103-101	● noir/negro	x1	10	530	220	405	0,75	mc. 0.017
132105-101	● blanc/blanco	x1	10	530	220	405	0,75	mc. 0.017
132104-101	● gris/gris	x1	10	530	220	405	0,75	mc. 0.017
132115-101	● bleu/azul	x1	10	530	220	405	0,75	mc. 0.017

16 genesis - cadre de dossier en plastique pour treillis genesis - marco de respaldo de plástico para red

code	finishing	q.kit	q.pack	a	b	c	kg.x1	vol.x1
132103-103	● noir/negro	x1	10	425	140	355	0,30	mc. 0.004
132105-103	● blanc/blanco	x1	10	425	140	355	0,30	mc. 0.004
132104-103	● gris/gris	x1	10	425	140	355	0,30	mc. 0.004
132115-103	● bleu/azul	x1	10	425	140	355	0,30	mc. 0.004

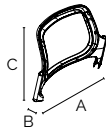

15 genesis - châssis porteur de dossier en plastique genesis - estructura de respaldo de plástico

code	finishing	q.kit	q.pack	a	b	c	kg.x1	vol.x1
132103-101	● noir/negro	x1	10	530	220	405	0,75	mc. 0.017
132105-101	● blanc/blanco	x1	10	530	220	405	0,75	mc. 0.017
132104-101	● gris/gris	x1	10	530	220	405	0,75	mc. 0.017
132115-101	● bleu/azul	x1	10	530	220	405	0,75	mc. 0.017

17 genesis - panneau en plastique pour dossier à tapisser genesis - tablero de plástico por tapizar

code	finishing	q.kit	q.pack	a	b	c	kg.x1	vol.x1
132103-102	● noir/negro	x1	10	425	140	355	0,674	mc. 0.004
132105-102	● blanc/blanco	x1	10	425	140	355	0,674	mc. 0.004
132104-102	● gris/gris	x1	10	425	140	355	0,674	mc. 0.004
132115-102	● bleu/azul	x1	10	425	140	355	0,674	mc. 0.004

bench/kit components

without armrests

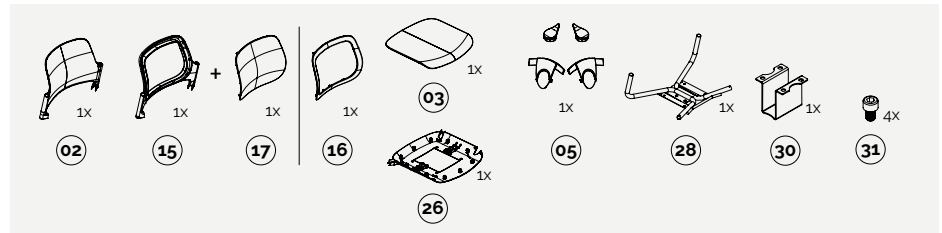
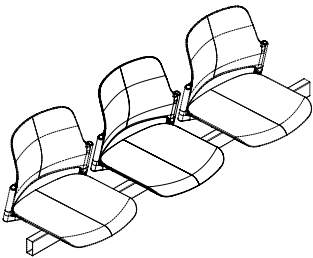

with armrests

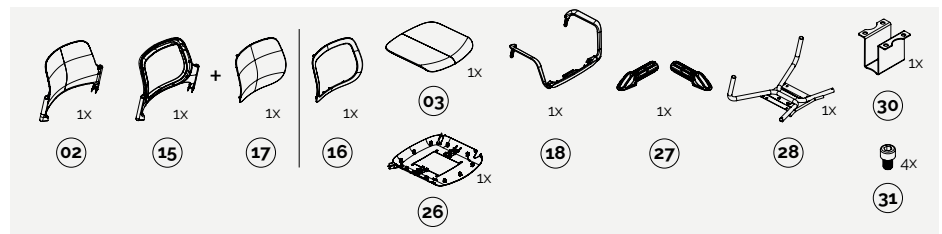
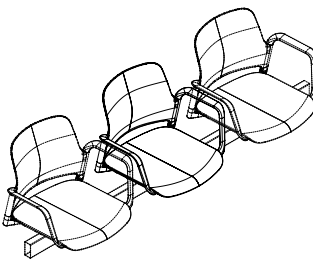

bench/leg options



plastic

metal

aluminium



gemma



discover more about
Gemma Collection

Caractérisée par ses lignes essentielles et décisives, Gemma est une chaise avec une coque monobloc en technopolymère proposée pour les environnements contractuels et domestiques.

La coque repose sur une large sélection de châssis et de bases qui confèrent à la collection un grand dynamisme d'utilisation, des zones d'attente aux bureaux et espaces de coworking, en passant par les contextes éducatifs et les bureaux à domicile.

Caracterizada por sus líneas esenciales y decididas, Gemma es una silla con una carcasa de tecnopolímero, propuesta tanto para entornos contractuales como domésticos.

La carcasa se apoya sobre una amplia selección de estructuras y bases que confieren a la colección un gran dinamismo de uso, desde zonas de espera, espacios de oficinas y coworking hasta contextos educativos y de oficinas en casa.

Plus

- Coque disponible en plastique recyclé post-consommation.
- Adaptée pour une utilisation en extérieur.
- Haute empilabilité.
- Certification EN 16139:2013+AC2013 Niveau 1.

- Carcasa disponible en plástico reciclado post-consumo.
- Apta para uso en exteriores.
- Alta apilabilidad.
- Certificación EN 16139:2013+AC2013 Nivel 1.



designed by:
Stefano Bettio



**recycled
plastic**



**certified
product**



**outdoor
ready**



**UV plastic
protection**



**trolley
available**

gemma

4-legs

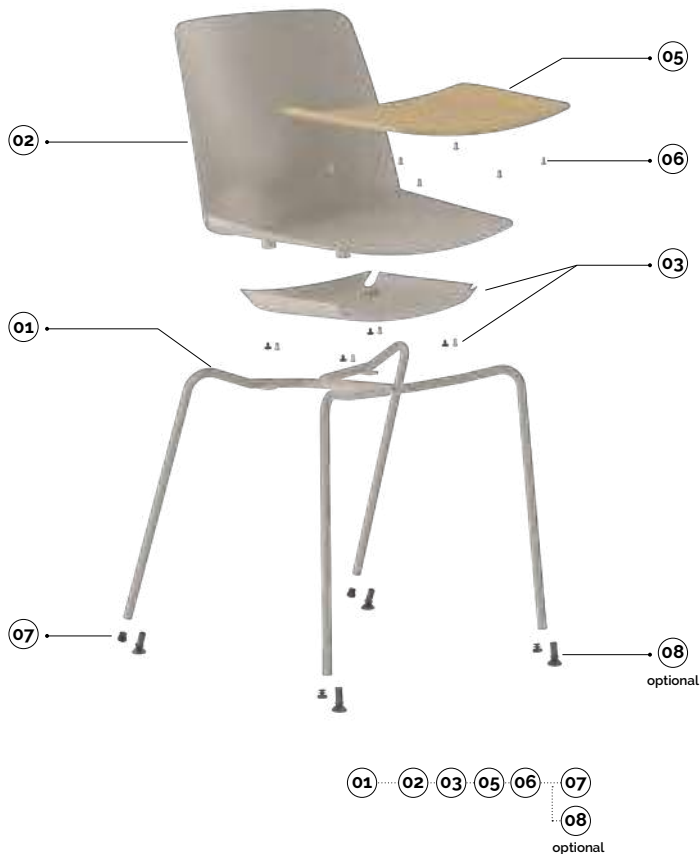
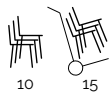

plastic colours

- noir/negro
- ivoire/marfil
- gris/gris
- jaune/amarillo
- vert/verde
- rouge/rojo

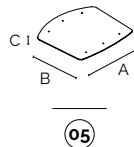
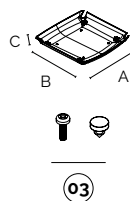
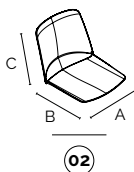
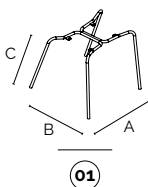

main component sizes

01 gemma - châssis à 4 pieds - ø16 sans bouchons

gemma - estructura de 4 patas - ø16 sin tapones

code	finishing	q.kit	q.pack	a	b	c	kg.x1	vol.x1
110103-527	● noir/negro	x1	200	520	535	440	2,15	mc. 0.02
110105-527	● ivoire/marfil	x1	200	520	535	440	2,15	mc. 0.02
110104-527	● gris/gris	x1	200	520	535	440	2,15	mc. 0.02
110108-527	● jaune/amarillo	x1	200	520	535	440	2,15	mc. 0.02
110116-527	● vert/verde	x1	200	520	535	440	2,15	mc. 0.02
110102-527	● rouge/rojo	x1	200	520	535	440	2,15	mc. 0.02
110110-527	● chromé/cromado	x1	200	520	535	440	2,15	mc. 0.02

02 gemma - coque en technopolymère anti-UV

gemma - carcasa de tecnopolimero anti-UV

code	finishing	q.kit	q.pack	a	b	c	kg.x1	vol.x1
133903-062	● noir/negro - recyclé/reciclado	x1	10	450	520	395	2,22	mc. 0.0193
133905-062	● ivoire/marfil	x1	10	450	520	395	2,22	mc. 0.0193
133904-062	● gris/gris	x1	10	450	520	395	2,22	mc. 0.0193
133908-062	● jaune/amarillo	x1	10	450	520	395	2,22	mc. 0.0193
133916-062	● vert/verde	x1	10	450	520	395	2,22	mc. 0.0193
133902-062	● rouge/rojo	x1	10	450	520	395	2,22	mc. 0.0193

03 gemma - technopolymère anti-UV couvercle inférieur + vis + entretoises

gemma - cubierta inferior de tecnopolimero anti-UV + tornillos + separadores

code	finishing	q.kit	q.pack	a	b	c	kg.x1	vol.x1
132203-093	● noir/negro - recyclé/reciclado	x1	20	302	323	50	0,29	mc. 0.0017
132205-093	● ivoire/marfil	x1	20	302	323	50	0,29	mc. 0.0017
132204-093	● gris/gris	x1	20	302	323	50	0,29	mc. 0.0017
132208-093	● jaune/amarillo	x1	20	302	323	50	0,29	mc. 0.0017
132216-093	● vert/verde	x1	20	302	323	50	0,29	mc. 0.0017
132202-093	● rouge/rojo	x1	20	302	323	50	0,29	mc. 0.0017

05 gemma - panneau de siège en contreplaqué avec 6 goujons

gemma - panel de asiento de madera de haya contrachapada con 6 clavos

code	finishing	q.kit	q.pack	a	b	c	kg.x1	vol.x1
122207-028	● hêtre/haya	x1	20	415	395	6,5	1	mc. 0.001

06 gemma - vis pour la fixation du panneau

gemma - bolsa de tornillos para la fijación del panel

code	finishing	q.kit	q.pack
117011-080	● galvanisé/galvanizado	x6	120

07 gemma - bouchon rond à ailettes - ø16

gemma - punta de aleta redonda para patas - ø16

code	finishing	q.kit
134203-160	● noir/negro	x4

08 gemma - pied à bascule variable en plastique ø16

gemma - pie basculante variable de plástico ø16

code	finishing	q.kit
134203-163	● noir/negro	x4

30 gemma - chariot porte-chaises avec accessoires

gemma - carro para sillas con accesorios

code	finishing	q.kit
110803-447	● noir/negro	x1



gemma

4-legs w/armrests

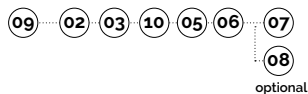
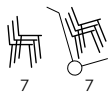

plastic colours

- noir/negro
- ivoire/marfil
- gris/gris
- jaune/amarillo
- vert/verde
- rouge/rojo

main component sizes

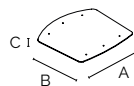
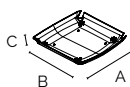
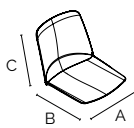
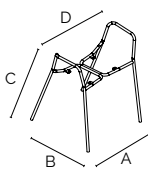

09 gemma - châssis 4 pieds avec accoudoirs - ø16 sans bouchons
gemma - estructura de 4 patas con reposabrazos - ø16 sin tapones

code	finishing	q.kit	q.pack	a	b	c	d	kg.x1	vol.x1
110103-536	● noir/negro	x1	60	495	555	440	670	2,95	mc. 0.035
110105-536	● ivoire/marfil	x1	60	495	555	440	670	2,95	mc. 0.035
110104-536	● gris/gris	x1	60	495	555	440	670	2,95	mc. 0.035
110110-536	● chromé/cromado	x1	60	495	555	440	670	2,95	mc. 0.035

● ● ● colori disponibili solo in quantità minima d'ordine
colour only available in minimum order quantities

02 gemma - coque en technopolymère anti-UV
gemma - carcasa de tecnopolimero anti-UV

code	finishing	q.kit	q.pack	a	b	c	kg.x1	vol.x1
133903-062	● noir/negro - recyclé/reciclado	x1	10	450	520	395	2,22	mc. 0.0193
133905-062	● ivoire/marfil	x1	10	450	520	395	2,22	mc. 0.0193
133904-062	● gris/gris	x1	10	450	520	395	2,22	mc. 0.0193
133908-062	● jaune/amarillo	x1	10	450	520	395	2,22	mc. 0.0193
133916-062	● vert/verde	x1	10	450	520	395	2,22	mc. 0.0193
133902-062	● rouge/rojo	x1	10	450	520	395	2,22	mc. 0.0193

03 gemma - technopolymère anti-UV couvercle inférieur + vis + entretoises
gemma - cubierta inferior de tecnopolimero anti-UV + tornillos + separadores

code	finishing	q.kit	q.pack	a	b	c	kg.x1	vol.x1
132203-093	● noir/negro - recyclé/reciclado	x1	20	302	323	50	0,29	mc. 0.0017
132205-093	● ivoire/marfil	x1	20	302	323	50	0,29	mc. 0.0017
132204-093	● gris/gris	x1	20	302	323	50	0,29	mc. 0.0017
132208-093	● jaune/amarillo	x1	20	302	323	50	0,29	mc. 0.0017
132216-093	● vert/verde	x1	20	302	323	50	0,29	mc. 0.0017
132202-093	● rouge/rojo	x1	20	302	323	50	0,29	mc. 0.0017

10 gemma - paire d'accoudoirs en technopolymère anti-UV + vis
gemma - par de reposabrazos de tecnopolimero anti UV + tornillos

code	finishing	q.kit	q.pack	a	b	c	kg.x1
131703-076	● noir/negro - recyclé/reciclado	x1	20	165	50	25	0,075
131705-076	● ivoire/marfil	x1	20	165	50	25	0,075
131704-076	● gris/gris	x1	20	165	50	25	0,075
131708-076	● jaune/amarillo	x1	20	165	50	25	0,075
131716-076	● vert/verde	x1	20	165	50	25	0,075
131702-076	● rouge/rojo	x1	20	165	50	25	0,075

for the components below, see the previous pages

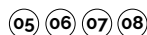

gemma

4-legs w/writing tablet

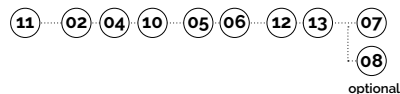
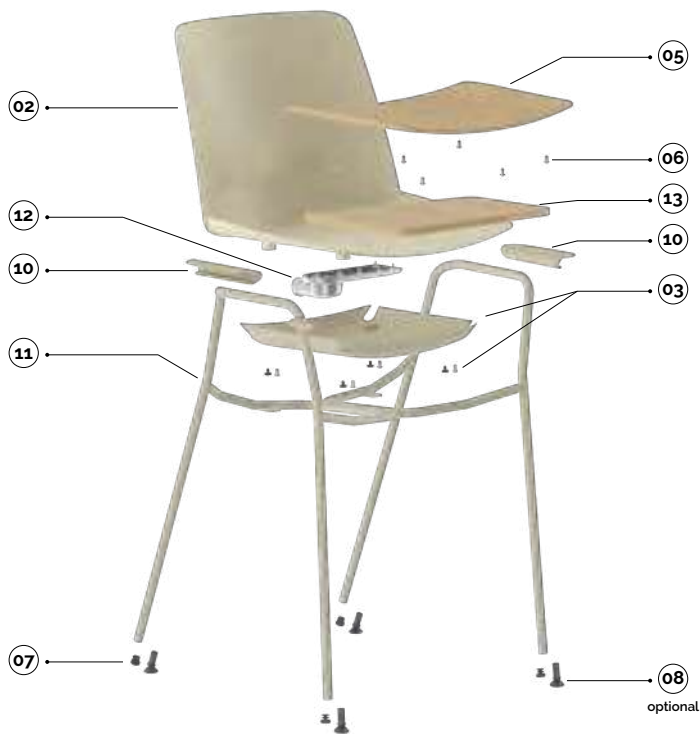
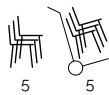

plastic colours

- noir/negro
- ivoire/marfil
- gris/gris
- jaune/amarillo
- vert/verde
- rouge/rojo

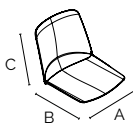
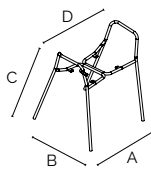

11

02

main component sizes

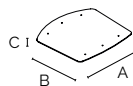
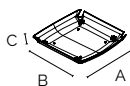

03

05



07

08

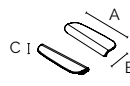

10

12



13

11 gemma - châssis à 4 pieds avec accoudoirs et fixation pour tablette - ø16 sans bouchons
gemma - estructura de 4 patas con reposabrazos y soporte para tableta - ø16 sin tapones

code	finishing	q.kit	q.pack	a	b	c	d	kg.x1	vol.x1
110103-577	● noir/negro	x1	50	495	555	440	670	3.04	mc. 0.035
110105-577	● ivoire/marfil	x1	50	495	555	440	670	3.04	mc. 0.035
110104-577	● gris/gris	x1	50	495	555	440	670	3.04	mc. 0.035
110110-577	● chromé/cromado	x1	50	495	555	440	670	3.04	mc. 0.035

● ● ● couleurs disponibles uniquement en quantités minimales de commande
colores disponibles sólo en cantidades mínimas de pedido

02 gemma - coque en technopolymère anti-UV
gemma - carcasa de tecnopolimero anti-UV

code	finishing	q.kit	q.pack	a	b	c	kg.x1	vol.x1
133903-062	● noir/negro - recyclé/reciclado	x1	10	450	520	395	2.22	mc. 0.0193
133905-062	● ivoire/marfil	x1	10	450	520	395	2.22	mc. 0.0193
133904-062	● gris/gris	x1	10	450	520	395	2.22	mc. 0.0193
133908-062	● jaune/amarillo	x1	10	450	520	395	2.22	mc. 0.0193
133916-062	● vert/verde	x1	10	450	520	395	2.22	mc. 0.0193
133902-062	● rouge/rojo	x1	10	450	520	395	2.22	mc. 0.0193

03 gemma - technopolymère anti-UV couvercle inférieur + vis + entretoises
gemma - cubierta inferior de tecnopolimero anti-UV + tornillos + separadores

code	finishing	q.kit	q.pack	a	b	c	kg.x1	vol.x1
132203-093	● noir/negro - recyclé/reciclado	x1	20	302	323	50	0.29	mc. 0.0017
132205-093	● ivoire/marfil	x1	20	302	323	50	0.29	mc. 0.0017
132204-093	● gris/gris	x1	20	302	323	50	0.29	mc. 0.0017
132208-093	● jaune/amarillo	x1	20	302	323	50	0.29	mc. 0.0017
132216-093	● vert/verde	x1	20	302	323	50	0.29	mc. 0.0017
132202-093	● rouge/rojo	x1	20	302	323	50	0.29	mc. 0.0017

12 gemma - joint de panique SPTA pour la fixation de la tablette
gemma - junta de antipánico SPTA para la fijación de tabletas

code	finishing	q.kit	q.pack	a	b	c	kg.x1	vol.x1
111701-900	● aluminium/aluminio droite/derecha	x1	10	180	66	15x15	0.365	mc. 0.001
111701-901	● aluminium/aluminio gauche/izquierda	x1	10	180	66	15x15	0.365	mc. 0.001

13 gemma - tablette en bois TL02 avec pre-perçage
gemma - tablero de madera TL02 con prefijsos

code	finishing	q.kit	q.pack	a	b	c	kg.x1	vol.x1
120307-021	● hêtre/haya droite/derecha	x1	10	342	245	196	0.65	mc. 0.009
120307-022	● hêtre/haya gauche/izquierda	x1	10	342	245	196	0.65	mc. 0.009

for the components below, see the previous pages

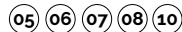

gemma

4-legs conference

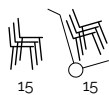

plastic colours

- noir/negro
- ivoire/marfil
- gris/gris
- jaune/amarillo
- vert/verde
- rouge/rojo

main component sizes

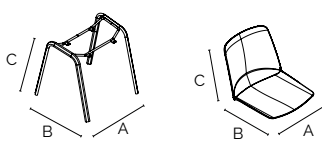

14

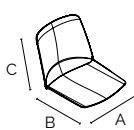

02

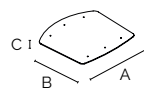

05



15



16



31 gemma - chariot porte-chaises avec accessoires pour la version Conference
gemma - carro para sillas con accesorios para versión Conference

code	finishing	q.kit
110803-465	● noir/negro	x1

14 gemma - châssis Conference à 4 pieds - sans bouchons
gemma - estructura de 4 patas Conference - sin tapones

code	finishing	q.kit	q.pack	a	b	c	kg.x1	vol.x1
110103-540	● noir/negro	x1	80	530	485	485	2,95	/
110105-540	● ivoire/marfil	x1	80	530	485	485	2,95	/
110104-540	● gris/gris	x1	80	530	485	485	2,95	/
110108-540	● jaune/amarillo	x1	80	530	485	485	2,95	/
110116-540	● vert/verde	x1	80	530	485	485	2,95	/
110102-540	● rouge/rojo	x1	80	530	485	485	2,95	/
110110-540	● chromé/cromado	x1	80	530	485	485	2,95	/

02 gemma - coque en technopolymère anti-UV
gemma - carcasa de tecnopolimero anti-UV

code	finishing	q.kit	q.pack	a	b	c	kg.x1	vol.x1
133903-062	● noir/negro - recyclé/reciclado	x1	10	450	520	395	2,22	mc. 0,0193
133905-062	● ivoire/marfil	x1	10	450	520	395	2,22	mc. 0,0193
133904-062	● gris/gris	x1	10	450	520	395	2,22	mc. 0,0193
133908-062	● jaune/amarillo	x1	10	450	520	395	2,22	mc. 0,0193
133916-062	● vert/verde	x1	10	450	520	395	2,22	mc. 0,0193
133902-062	● rouge/rojo	x1	10	450	520	395	2,22	mc. 0,0193

04 gemma - sac de vis TC+combi 6x16 tête cylindrique cruciforme - pour fixation du coque sans couvercle
gemma - bolsa de tornillos TC+combi 6x16 cabeza cilíndrica en cruz - para la fijación del carcasa sin cubierta

code	finishing	q.kit	q.pack
117011-078	● galvanisé/galvanizado	x4	40

05 gemma - panneau de siège en contreplaqué avec 6 goujons
gemma - panel de asiento de madera de haya contrachapada con 6 clavos

code	finishing	q.kit	q.pack	a	b	c	kg.x1	vol.x1
122207-028	● hêtre/haya	x1	20	415	395	6,5	1	mc. 0,001

06 gemma - vis pour la fixation du panneau
gemma - bolsa de tornillos para la fijación del panel

code	finishing	q.kit	q.pack
117011-080	● galvanisé/galvanizado	x6	120

15 gemma - embout ovale pour châssis Conference - 30x15
gemma - pie oval para pata para estructuras Conference - 30x15

code	finishing	q.kit
130303-024	● noir/negro	x4

16 gemma - entretoises à tête plate PF3 pour châssis Conference
gemma - separadores cabeza plana PF3 para estructuras Conference

code	finishing	q.kit
134006-102	● neutre/neutro	x4

gemma

4-legs conference with hooks

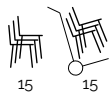

plastic colours

- noir/negro
- ivoire/marfil
- gris/gris
- jaune/amarillo
- vert/verde
- rouge/rojo

main component sizes

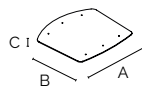
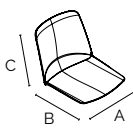
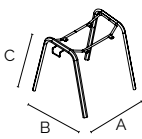

17 gemma - châssis Conference à 4 pieds avec crochets - sans bouchons

gemma - estructura de 4 patas Conference con ganchos - sin tapones

code	finishing	q.kit	q.pack	a	b	c	kg.x1	vol.x1
110103-541	● noir/negro	x1	80	530	485	485	3,00	/
110105-541	● ivoire/marfil	x1	80	530	485	485	3,00	/
110104-541	● gris/gris	x1	80	530	485	485	3,00	/
110110-541	● chromé/cromado	x1	80	530	485	485	3,00	/

● ● ● couleurs disponibles uniquement en quantités minimales de commande
colores disponibles sólo en cantidades mínimas de pedido

02 gemma - coque en technopolymère anti-UV

gemma - carcasa de tecnopolimero anti-UV

code	finishing	q.kit	q.pack	a	b	c	kg.x1	vol.x1
133903-062	● noir/negro - recyclé/reciclado	x1	10	450	520	395	2,22	mc. 0,0193
133905-062	● ivoire/marfil	x1	10	450	520	395	2,22	mc. 0,0193
133904-062	● gris/gris	x1	10	450	520	395	2,22	mc. 0,0193
133908-062	● jaune/amarillo	x1	10	450	520	395	2,22	mc. 0,0193
133916-062	● vert/verde	x1	10	450	520	395	2,22	mc. 0,0193
133902-062	● rouge/rojo	x1	10	450	520	395	2,22	mc. 0,0193

04 gemma - sac de vis TC+combi 6x16 tête cylindrique cruciforme - pour fixation du coque sans couvercle

gemma - bolsa de tornillos TC+combi 6x16 cabeza cilíndrica en cruz - para la fijación del carcasa sin cubierta

code	finishing	q.kit	q.pack
117011-078	● galvanisé/galvanizado	x4	40

05 gemma - panneau de siège en contreplaqué avec 6 goujons

gemma - panel de asiento de madera de haya contrachapada con 6 clavos

code	finishing	q.kit	q.pack	a	b	c	kg.x1	vol.x1
122207-028	● hêtre/haya	x1	20	415	395	6,5	1	mc. 0,001

06 gemma - vis pour la fixation du panneau

gemma - bolsa de tornillos para la fijación del panel

code	finishing	q.kit	q.pack
117011-080	● galvanisé/galvanizado	x6	120

15 gemma - embout ovale pour châssis Conference - 30x15

gemma - pie oval para pata para estructuras Conference - 30x15

code	finishing	q.kit
130303-024	● noir/negro	x4

16 gemma - entretoises à tête plate PF3 pour châssis Conference

gemma - separadores cabeza plana PF3 para estructuras Conference

code	finishing	q.kit
134006-102	● neutre/neutro	x4

17 02 04 05 06 15 16

gemma

sled

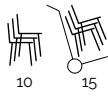

plastic colours

- noir/negro
- ivoire/marfil
- gris/gris
- jaune/amarillo
- vert/verde
- rouge/rojo

main component sizes

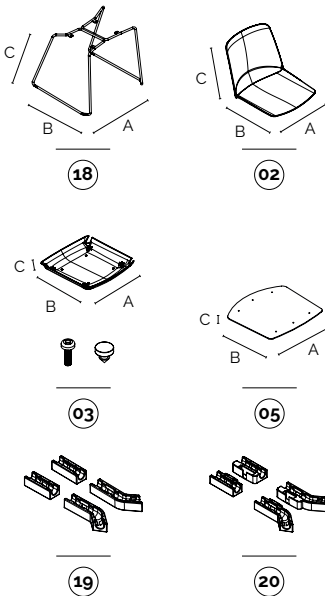

18 gemma - châssis de traineau à tige - ø12 gemma - estructura de patín de varilla - ø12

code	finishing	q.kit	q.pack	a	b	c	kg.x1	vol.x1
113403-452	● noir/negro	x1	100	575	525	480	3,95	mc. 0.03
113405-452	● ivoire/marfil	x1	100	575	525	480	3,95	mc. 0.03
113404-452	● gris/gris	x1	100	575	525	480	3,95	mc. 0.03
113408-452	● jaune/amarillo	x1	100	575	525	480	3,95	mc. 0.03
113416-452	● vert/verde	x1	100	575	525	480	3,95	mc. 0.03
113402-452	● rouge/rojo	x1	100	575	525	480	3,95	mc. 0.03
113410-452	● chromé/cromado	x1	100	575	525	480	3,95	mc. 0.03

02 gemma - coque en technopolymère anti-UV gemma - carcasa de tecnopolimero anti-UV

code	finishing	q.kit	q.pack	a	b	c	kg.x1	vol.x1
133903-062	● noir/negro - recyclé/reciclado	x1	10	450	520	395	2,22	mc. 0.0193
133905-062	● ivoire/marfil	x1	10	450	520	395	2,22	mc. 0.0193
133904-062	● gris/gris	x1	10	450	520	395	2,22	mc. 0.0193
133908-062	● jaune/amarillo	x1	10	450	520	395	2,22	mc. 0.0193
133916-062	● vert/verde	x1	10	450	520	395	2,22	mc. 0.0193
133902-062	● rouge/rojo	x1	10	450	520	395	2,22	mc. 0.0193

03 gemma - technopolymère anti-UV couvercle inférieur + vis + entretoises gemma - cubierta inferior de tecnopolimero anti-UV + tornillos + separadores

code	finishing	q.kit	q.pack	a	b	c	kg.x1	vol.x1
132203-093	● noir/negro - recyclé/reciclado	x1	20	302	323	50	0,29	mc. 0.0017
132205-093	● ivoire/marfil	x1	20	302	323	50	0,29	mc. 0.0017
132204-093	● gris/gris	x1	20	302	323	50	0,29	mc. 0.0017
132208-093	● jaune/amarillo	x1	20	302	323	50	0,29	mc. 0.0017
132216-093	● vert/verde	x1	20	302	323	50	0,29	mc. 0.0017
132202-093	● rouge/rojo	x1	20	302	323	50	0,29	mc. 0.0017

05 gemma - panneau de siège en contreplaqué avec 6 goujons gemma - panel de asiento de madera de haya contrachapada con 6 clavos

code	finishing	q.kit	q.pack	a	b	c	kg.x1	vol.x1
122207-028	● hêtre/haya	x1	20	415	395	6,5	1	mc. 0.001

06 gemma - vis pour la fixation du panneau gemma - bolsa de tornillos para la fijación del panel

code	finishing	q.kit	q.pack
117011-080	● galvanisé/galvanizado	x6	120

19 gemma - kit de pied BTF gemma - bolsa de pie BTF

code	finishing	q.kit	q.pack
134306-001	● neutre/neutro	x1	100

20 gemma - kit de pied avec crochets BTFA gemma - bolsa de pie con ganchos BTFA

code	finishing	q.kit	q.pack
134306-002	● neutre/neutro	x1	100

gemma

4-spoke base



21 02 04 05 06 22

plastic colours

- noir/negro
- ivoire/marfil
- gris/gris
- jaune/amarillo
- vert/verde
- rouge/rojo

21 gemma - base fixe à 4 branches pour roulettes avec réducteurs

gemma - base fija de 4 radios para ruedas con reductores

code	finishing	q.kit	q.pack	a	b	c	kg.x1	vol.x1
110903-293	● noir/negro	x1	30	660	475	380	3,45	mc. 0.10
110905-293	● ivoire/marfil	x1	30	660	475	380	3,45	mc. 0.10
110904-293	● gris/gris	x1	30	660	475	380	3,45	mc. 0.10
110910-293	● chromé/cromado	x1	30	660	475	380	3,45	mc. 0.10

● ● ● couleurs disponibles uniquement en quantités minimales de commande
colores disponibles sólo en cantidades mínimas de pedido

02 gemma - coque en technopolymère anti-UV

gemma - carcasa de tecnopolimero anti-UV

code	finishing	q.kit	q.pack	a	b	c	kg.x1	vol.x1
133903-062	● noir/negro - recyclé/reciclado	x1	10	450	520	395	2,22	mc. 0.0193
133905-062	● ivoire/marfil	x1	10	450	520	395	2,22	mc. 0.0193
133904-062	● gris/gris	x1	10	450	520	395	2,22	mc. 0.0193
133908-062	● jaune/amarillo	x1	10	450	520	395	2,22	mc. 0.0193
133916-062	● vert/verde	x1	10	450	520	395	2,22	mc. 0.0193
133902-062	● rouge/rojo	x1	10	450	520	395	2,22	mc. 0.0193

04 gemma - sac de vis TC+combi 6x16 tête cylindrique cruciforme - pour fixation du coque sans couvercle

gemma - bolsa de tornillos TC+combi 6x16 cabeza cilíndrica en cruz - para la fijación del carcasa sin cubierta

code	finishing	q.kit	q.pack
117011-078	● galvanisé/galvanizado	x4	40

05 gemma - panneau de siège en contreplaqué avec 6 goujons

gemma - panel de asiento de madera de haya contrachapada con 6 clavos

code	finishing	q.kit	q.pack	a	b	c	kg.x1	vol.x1
122207-028	● hêtre/haya	x1	20	415	395	6,5	1	mc. 0.001

06 gemma - vis pour la fixation du panneau

gemma - bolsa de tornillos para la fijación del panel

code	finishing	q.kit	q.pack
117011-080	● galvanisé/galvanizado	x6	120

22 gemma - desmopan double roue avec goujon monté - ø50

gemma - doble rueda de desmopan con pivote montado - ø50

code	finishing	q.kit	kg.x1
134403-003	● noir/negro	x4	0,05

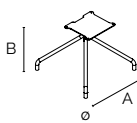

21

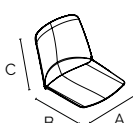

02

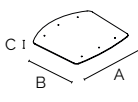

05



22

main component sizes

gemma

swivel base



23 02 04 05 06 24

plastic colours

- noir/negro
- ivoire/marfil
- gris/gris
- jaune/amarillo
- vert/verde
- rouge/rojo

main component sizes

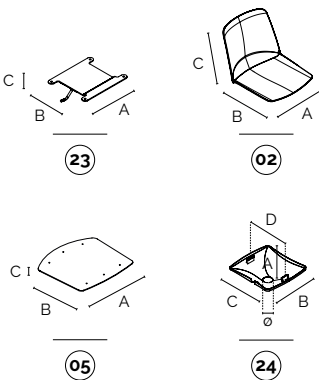

23 gemma - plaque peinte pour plateau tournant + spatule

gemma - placa pintada para base giratoria + espátula

code	finishing	q.kit	q.pack	a	b	c	kg.x1	vol.x1
110903-290	● noir/negro	x1	10	258	228	75	2,30	mc. 0,004

02 gemma - coque en technopolymère anti-UV

gemma - carcasa de tecnopolimero anti-UV

code	finishing	q.kit	q.pack	a	b	c	kg.x1	vol.x1
133903-062	● noir/negro - recyclé/reciclado	x1	10	450	520	395	2,22	mc. 0,0193
133905-062	● ivoire/marfil	x1	10	450	520	395	2,22	mc. 0,0193
133904-062	● gris/gris	x1	10	450	520	395	2,22	mc. 0,0193
133908-062	● jaune/amarillo	x1	10	450	520	395	2,22	mc. 0,0193
133916-062	● vert/verde	x1	10	450	520	395	2,22	mc. 0,0193
133902-062	● rouge/rojo	x1	10	450	520	395	2,22	mc. 0,0193

04 gemma - sac de vis TC+combi 6x16 tête cylindrique cruciforme - pour fixation du coque sans couvercle

gemma - bolsa de tornillos TC+combi 6x16 cabeza cilíndrica en cruz - para la fijación del carcasa sin cubierta

code	finishing	q.kit	q.pack
117011-078	● galvanisé/galvanizado	x4	40

05 gemma - panneau de siège en contreplaqué avec 6 goujons

gemma - panel de asiento de madera de haya contrachapada con 6 clavos

code	finishing	q.kit	q.pack	a	b	c	kg.x1	vol.x1
122207-028	● hêtre/haya	x1	20	415	395	6,5	1	mc. 0,001

06 gemma - vis pour la fixation du panneau

gemma - bolsa de tornillos para la fijación del panel

code	finishing	q.kit	q.pack
117011-080	● galvanisé/galvanizado	x6	120

24 gemma - couvercle en plastique CPG pour cadre pivotant

gemma - cubierta de de tecnopolimero CPG para base giratoria

code	finishing	q.kit	q.pack	a	b	c	d	ø	kg.x1	vol.x1
130903-000	● noir/negro	x1	50	60	200	210	167	36	0,1	mc. 0,0008

gemma

low stool h.650



6

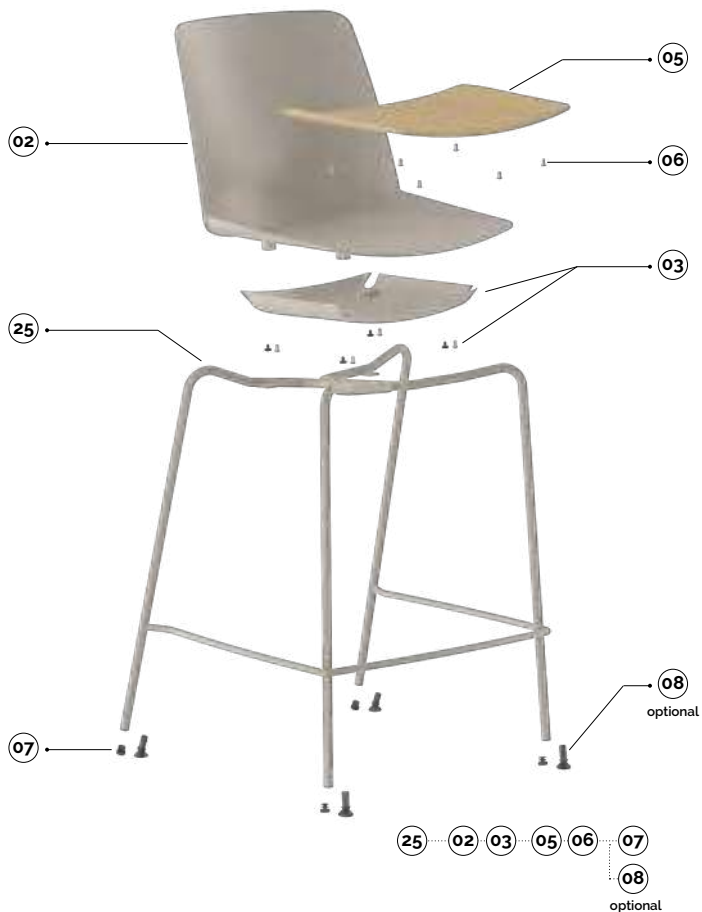

plastic colours

- noir/negro
- ivoire/marfil
- gris/gris
- jaune/amarillo
- vert/verde
- rouge/rojo

main component sizes

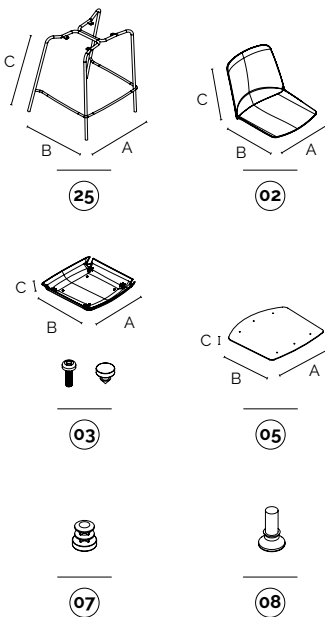

25 gemma - châssis de tabouret bas - h.650 ø16 sans bouchons
gemma - estructura de taburete bajo - h.650 ø16 sin tapones

code	finishing	q.kit	q.pack	a	b	c	kg.x1	vol.x1
110603-692	● noir/negro	x1	50	555	545	630	3,92	mc. 0.08
110605-692	● ivoire/marfil	x1	50	555	545	630	3,92	mc. 0.08
110604-692	● gris/gris	x1	50	555	545	630	3,92	mc. 0.08
110610-692	● chromé/cromado	x1	50	555	545	630	3,92	mc. 0.08

● ● ● couleurs disponibles uniquement en quantités minimales de commande
colores disponibles sólo en cantidades mínimas de pedido

02 gemma - coque en technopolymère anti-UV
gemma - carcasa de tecnopolimero anti-UV

code	finishing	q.kit	q.pack	a	b	c	kg.x1	vol.x1
133903-062	● noir/negro - recyclé/reciclado	x1	10	450	520	395	2,22	mc. 0.0193
133905-062	● ivoire/marfil	x1	10	450	520	395	2,22	mc. 0.0193
133904-062	● gris/gris	x1	10	450	520	395	2,22	mc. 0.0193
133908-062	● jaune/amarillo	x1	10	450	520	395	2,22	mc. 0.0193
133916-062	● vert/verde	x1	10	450	520	395	2,22	mc. 0.0193
133902-062	● rouge/rojo	x1	10	450	520	395	2,22	mc. 0.0193

03 gemma - technopolymère anti-UV couvercle inférieur + vis + entretoises
gemma - cubierta inferior de tecnopolimero anti-UV + tornillos + separadores

code	finishing	q.kit	q.pack	a	b	c	kg.x1	vol.x1
132203-093	● noir/negro - recyclé/reciclado	x1	20	302	323	50	0,29	mc. 0.0017
132205-093	● ivoire/marfil	x1	20	302	323	50	0,29	mc. 0.0017
132204-093	● gris/gris	x1	20	302	323	50	0,29	mc. 0.0017
132208-093	● jaune/amarillo	x1	20	302	323	50	0,29	mc. 0.0017
132216-093	● vert/verde	x1	20	302	323	50	0,29	mc. 0.0017
132202-093	● rouge/rojo	x1	20	302	323	50	0,29	mc. 0.0017

05 gemma - panneau de siège en contreplaqué avec 6 goujons
gemma - panel de asiento de madera de haya contrachapada con 6 clavos

code	finishing	q.kit	q.pack	a	b	c	kg.x1	vol.x1
122207-028	● hêtre/haya	x1	20	415	395	6,5	1	mc. 0.001

06 gemma - vis pour la fixation du panneau
gemma - bolsa de tornillos para la fijación del panel

code	finishing	q.kit	q.pack
117011-080	● galvanisé/galvanizado	x6	120

07 gemma - bouchon rond à ailettes - ø16
gemma - punta de aleta redonda para patas - ø16

code	finishing	q.kit
134203-160	● noir/negro	x4

08 gemma - pied à bascule variable en plastique ø16
gemma - pie basculante variable de plástico ø16

code	finishing	q.kit
134203-163	● noir/negro	x4

gemma

high stool h.750



6



plastic colours

- noir/negro
- ivoire/marfil
- gris/gris
- jaune/amarillo
- vert/verde
- rouge/rojo

main component sizes

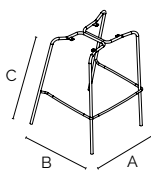

26

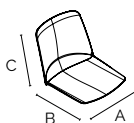

02



03

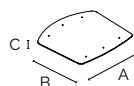

05

07



08

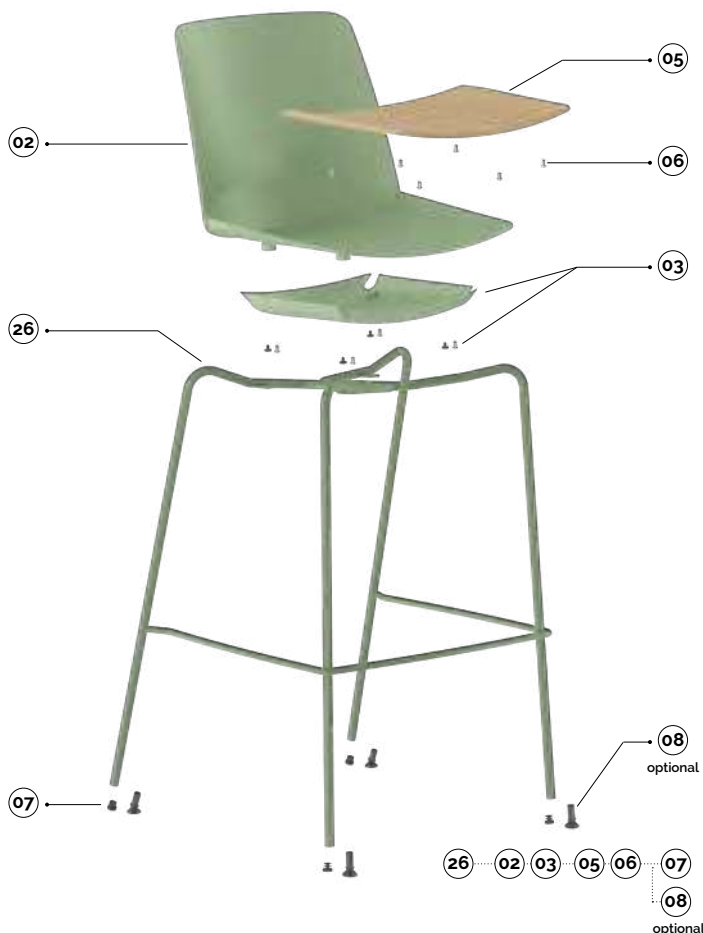

26 gemma - châssis de tabouret haut - h.750 ø16 sans bouchons
gemma - estructura de taburete alto - h.750 ø16 sin tapones

code	finishing	q.kit	q.pack	a	b	c	kg.x1	vol.x1
110603-696	● noir/negro	x1	50	560	545	730	4.20	mc. 0.08
110605-696	● ivoire/marfil	x1	50	560	545	730	4.20	mc. 0.08
110604-696	● gris/gris	x1	50	560	545	730	4.20	mc. 0.08
110610-696	● chromé/cromado	x1	50	560	545	730	4.20	mc. 0.08

● ● ● couleurs disponibles uniquement en quantités minimales de commande
colores disponibles sólo en cantidades mínimas de pedido

02 gemma - coque en technopolymère anti-UV
gemma - carcasa de tecnopolimero anti-UV

code	finishing	q.kit	q.pack	a	b	c	kg.x1	vol.x1
133903-062	● noir/negro - recyclé/reciclado	x1	10	450	520	395	2.22	mc. 0.0193
133905-062	● ivoire/marfil	x1	10	450	520	395	2.22	mc. 0.0193
133904-062	● gris/gris	x1	10	450	520	395	2.22	mc. 0.0193
133908-062	● jaune/amarillo	x1	10	450	520	395	2.22	mc. 0.0193
133916-062	● vert/verde	x1	10	450	520	395	2.22	mc. 0.0193
133902-062	● rouge/rojo	x1	10	450	520	395	2.22	mc. 0.0193

03 gemma - technopolymère anti-UV couvercle inférieur + vis + entretoises
gemma - cubierta inferior de tecnopolimero anti-UV + tornillos + separadores

code	finishing	q.kit	q.pack	a	b	c	kg.x1	vol.x1
132203-093	● noir/negro - recyclé/reciclado	x1	20	302	323	50	0.29	mc. 0.0017
132205-093	● ivoire/marfil	x1	20	302	323	50	0.29	mc. 0.0017
132204-093	● gris/gris	x1	20	302	323	50	0.29	mc. 0.0017
132208-093	● jaune/amarillo	x1	20	302	323	50	0.29	mc. 0.0017
132216-093	● vert/verde	x1	20	302	323	50	0.29	mc. 0.0017
132202-093	● rouge/rojo	x1	20	302	323	50	0.29	mc. 0.0017

05 gemma - panneau de siège en contreplaqué avec 6 goujons
gemma - panel de asiento de madera de haya contrachapada con 6 clavos

code	finishing	q.kit	q.pack	a	b	c	kg.x1	vol.x1
122207-028	● hêtre/haya	x1	20	415	395	6,5	1	mc. 0.001

06 gemma - vis pour la fixation du panneau
gemma - bolsa de tornillos para la fijación del panel

code	finishing	q.kit	q.pack
117011-080	● galvanisé/galvanizado	x6	120

07 gemma - bouchon rond à ailettes - ø16
gemma - punta de aleta redonda para patas - ø16

code	finishing	q.kit
134203-160	● noir/negro	x4

08 gemma - pied à bascule variable en plastique ø16
gemma - pie basculante variable de plástico ø16

code	finishing	q.kit
134203-163	● noir/negro	x4

gemma

bench



27 02 04 05 06 28 29

plastic colours

- noir/negro
- ivoire/marfil
- gris/gris
- jaune/amarillo
- vert/verde
- rouge/rojo

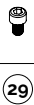
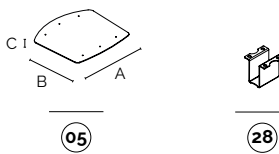
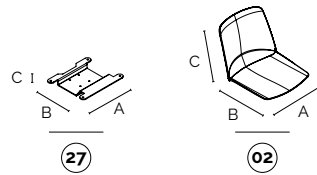

main component sizes

27 gemma - plaque peinte pour la fixation du coque sur poutre
gemma - plancha pintada para la fijación del cuerpo en la viga

code	finishing	q.kit	q.pack	a	b	c	kg.x1	vol.x1
110703-605	● noir/negro	x1	10	258	231	40	1.60	mc. 0.0002

02 gemma - coque en technopolymère anti-UV
gemma - carcasa de tecnopolimero anti-UV

code	finishing	q.kit	q.pack	a	b	c	kg.x1	vol.x1
133903-062	● noir/negro - recyclé/reciclado	x1	10	450	520	395	2.22	mc. 0.0193
133905-062	● ivoire/marfil	x1	10	450	520	395	2.22	mc. 0.0193
133904-062	● gris/gris	x1	10	450	520	395	2.22	mc. 0.0193
133908-062	● jaune/amarillo	x1	10	450	520	395	2.22	mc. 0.0193
133916-062	● vert/verde	x1	10	450	520	395	2.22	mc. 0.0193
133902-062	● rouge/rojo	x1	10	450	520	395	2.22	mc. 0.0193

04 gemma - sac de vis TC+combi 6x16 tête cylindrique cruciforme - pour fixation du coque sans couvercle
gemma - bolsa de tornillos TC+combi 6x16 cabeza cilíndrica en cruz - para la fijación del carcasa sin cubierta

code	finishing	q.kit	q.pack
117011-078	● galvanisé/galvanizado	x4	40

05 gemma - panneau de siège en contreplaqué avec 6 goujons
gemma - panel de asiento de madera de haya contrachapada con 6 clavos

code	finishing	q.kit	q.pack	a	b	c	kg.x1	vol.x1
122207-028	● hêtre/haya	x1	20	415	395	6,5	1	mc. 0,001

06 gemma - vis pour la fixation du panneau
gemma - bolsa de tornillos para la fijación del panel

code	finishing	q.kit	q.pack
117011-080	● galvanisé/galvanizado	x6	120

28 gemma - support de poutre
gemma - soporte de viga

code	finishing	q.kit	q.pack	a	b	kg.x1	vol.x1
110703-007	● noir/negro	x1	50	55	65	0.60	mc. 0.0005

29 gemma - sac de vis à tête cylindrique M8x12
gemma - bolsa de tornillos M8x12 de cabeza cilíndrica y hexágono empotrado

code	finishing	q.kit	q.pack
117003-070	● noir/negro	x4	200

for the bench components, see page 417

optionals

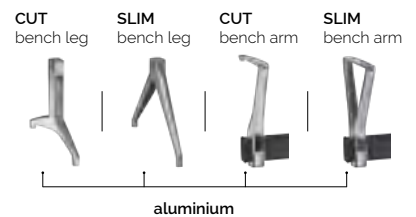
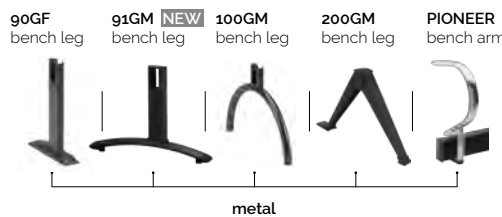





lemon



discover more about
Lemon Collection

Lemon est une collection complète de sièges et de tables, idéale pour une utilisation en extérieur, mais pas seulement.

La collection est proposée dans une sélection raffinée et contemporaine de couleurs et de finitions, tant en versions chaise et tabouret qu'en large gamme de tables.

Lemon es una colección completa de asientos y mesas, ideal sobre todo para exteriores.

La colección se ofrece en una selección refinada y contemporánea de colores y acabados, tanto en versiones de silla y taburete, como en una amplia gama de mesas.

Plus

- Large gamme de couleurs disponibles.
- Chaises et tabourets pouvant être combinés avec des tables de différentes tailles et formats.
- Certification EN 16139:2013+AC2013 Niveau 2. Certification ANSI/BIFMA.
- *Amplia gama de colores disponibles.*
- *Sillas y taburetes combinables con mesas de diferentes tamaños y formatos.*
- *Certificación EN 16139:2013+AC2013 Nivel 2. Certificación ANSI/BIFMA.*



designed by:
Pio e Tito Toso



**outdoor
ready**



**UV plastic
protection**



**certified
product**

lemon

4-legs

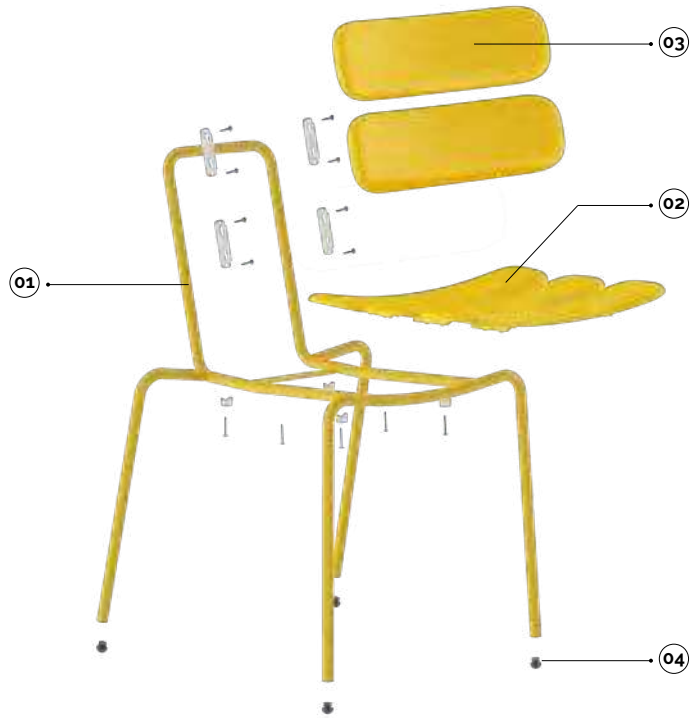
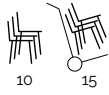

01 02 03 04

plastic colours

- noir/negro
- ivoire/marfil
- gris/gris
- jaune/amarillo
- vert/verde
- rouge/rojo

main component sizes

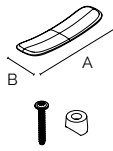
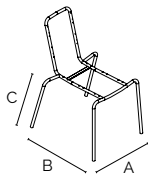

01

02

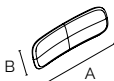

03

04

01 lemon - châssis à 4 pieds d.18 sans embouts
lemon - estructura 4 patas d.18 sin tapones

code	finishing	q.kit	q.pack	a	b	c	kg.x1	vol.x1
110103-551	● noir/negro*	x1	100	520	565	450	3.20	mc. 0.04
110105-551	● ivoire/marfil*	x1	100	520	565	450	3.20	mc. 0.04
110104-551	● gris/gris*	x1	100	520	565	450	3.20	mc. 0.04
110108-551	● jaune/amarillo	x1	100	520	565	450	3.20	mc. 0.04
110116-551	● vert/verde*	x1	100	520	565	450	3.20	mc. 0.04
110102-551	● rouge/rojo*	x1	100	520	565	450	3.20	mc. 0.04
110110-551	● chromé/cromado**	x1	100	520	565	450	3.20	mc. 0.04

* outdoor/indoor
** indoor

02 lemon - latte en plastique pour assise + vis + entretoises
lemon - duela de asiento de plástico + tornillos + parachoques

code	finishing	q.kit	q.pack	a	b	kg.x1	vol.x1
132203-110	● noir/negro	x3	30	460	135	0.35	mc. 0.002706
132205-110	● ivoire/marfil	x3	30	460	135	0.35	mc. 0.002706
132204-110	● gris/gris	x3	30	460	135	0.35	mc. 0.002706
132208-110	● jaune/amarillo	x3	30	460	135	0.35	mc. 0.002706
132216-110	● vert/verde	x3	30	460	135	0.35	mc. 0.002706
132202-110	● rouge/rojo	x3	30	460	135	0.35	mc. 0.002706

03 lemon - latte en plastique pour dossier + inserts + vis
lemon - duela de respaldo de plástico + insertos + tornillos

code	finishing	q.kit	q.pack	a	b	kg.x1	vol.x1
132103-110	● noir/negro	x2	20	460	135	0.35	mc. 0.004059
132105-110	● ivoire/marfil	x2	20	460	135	0.35	mc. 0.004059
132104-110	● gris/gris	x2	20	460	135	0.35	mc. 0.004059
132108-110	● jaune/amarillo	x2	20	460	135	0.35	mc. 0.004059
132116-110	● vert/verde	x2	20	460	135	0.35	mc. 0.004059
132102-110	● rouge/rojo	x2	20	460	135	0.35	mc. 0.004059

04 lemon - T118 - embout à ailettes tête sphérique d.18 noir
lemon - T118 - punta con aletas cabeza esférica d.18 negro

code	finishing	q.kit
134203-181	● noir/negro	x4

27 lemon - chariot porte-chaises avec accessoires
lemon - carro para sillas con accesorios

code	finishing	q.kit
110803-449	● noir/negro	x1



lemon

4-legs with arms

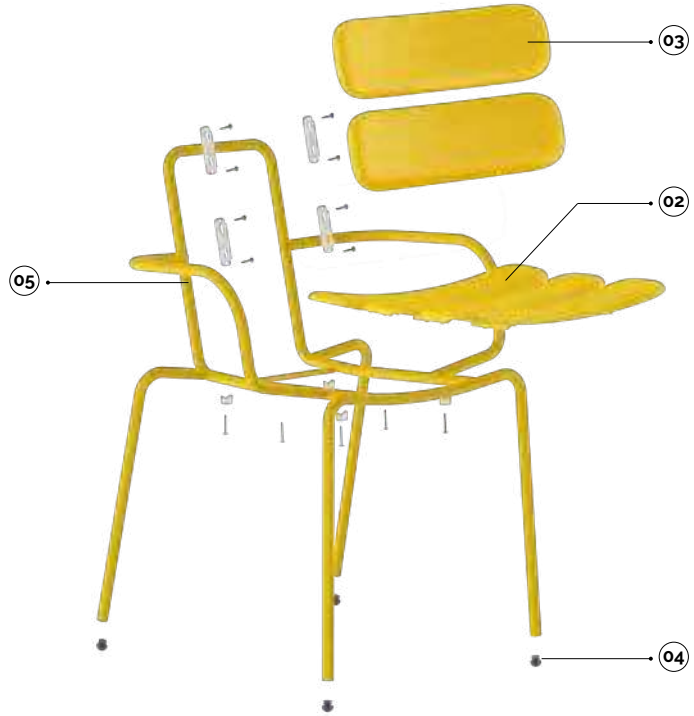
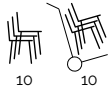

05 02 03 04

plastic colours

- noir/negro
- ivoire/marfil
- gris/gris
- jaune/amarillo
- vert/verde
- rouge/rojo

main component sizes

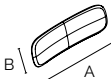
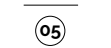
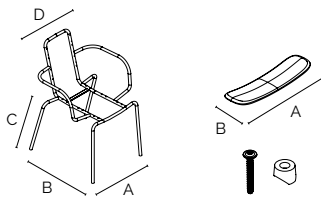

05

02

03

04

05 lemon - châssis 4 pieds avec accoudoirs d.18 sans embouts
lemon - estructura 4 patas con reposabrazos d.18 sin tapones

code	finishing	q.kit	q.pack	a	b	c	d	kg.x1	vol.x1
110103-556	● noir/negro*	x1	50	520	565	450	580	4.40	mc. 0.08
110105-556	● ivoire/marfil*	x1	50	520	565	450	580	4.40	mc. 0.08
110104-556	● gris/gris*	x1	50	520	565	450	580	4.40	mc. 0.08
110108-556	● jaune/amarillo	x1	50	520	565	450	580	4.40	mc. 0.08
110116-556	● vert/verde*	x1	50	520	565	450	580	4.40	mc. 0.08
110102-556	● rouge/rojo*	x1	50	520	565	450	580	4.40	mc. 0.08
110110-556	● chromé/cromado**	x1	50	520	565	450	580	4.40	mc. 0.08

* outdoor/indoor
** indoor

02 lemon - latte en plastique pour assise + vis + entretoises
lemon - duela de asiento de plástico + tornillos + parachoques

code	finishing	q.kit	q.pack	a	b	kg.x1	vol.x1
132203-110	● noir/negro	x3	30	460	135	0.35	mc. 0.002706
132205-110	● ivoire/marfil	x3	30	460	135	0.35	mc. 0.002706
132204-110	● gris/gris	x3	30	460	135	0.35	mc. 0.002706
132208-110	● jaune/amarillo	x3	30	460	135	0.35	mc. 0.002706
132216-110	● vert/verde	x3	30	460	135	0.35	mc. 0.002706
132202-110	● rouge/rojo	x3	30	460	135	0.35	mc. 0.002706

03 lemon - latte en plastique pour dossier + inserts + vis
lemon - duela de respaldo de plástico + insertos + tornillos

code	finishing	q.kit	q.pack	a	b	kg.x1	vol.x1
132103-110	● noir/negro	x2	20	460	135	0.35	mc. 0.004059
132105-110	● ivoire/marfil	x2	20	460	135	0.35	mc. 0.004059
132104-110	● gris/gris	x2	20	460	135	0.35	mc. 0.004059
132108-110	● jaune/amarillo	x2	20	460	135	0.35	mc. 0.004059
132116-110	● vert/verde	x2	20	460	135	0.35	mc. 0.004059
132102-110	● rouge/rojo	x2	20	460	135	0.35	mc. 0.004059

04 lemon - T118 - embout à ailettes tête sphérique d.18 noir
lemon - T118 - punta con aletas cabeza esférica d.18 negro

code	finishing	q.kit
134203-181	● noir/negro	x4

lemon

stool h.650

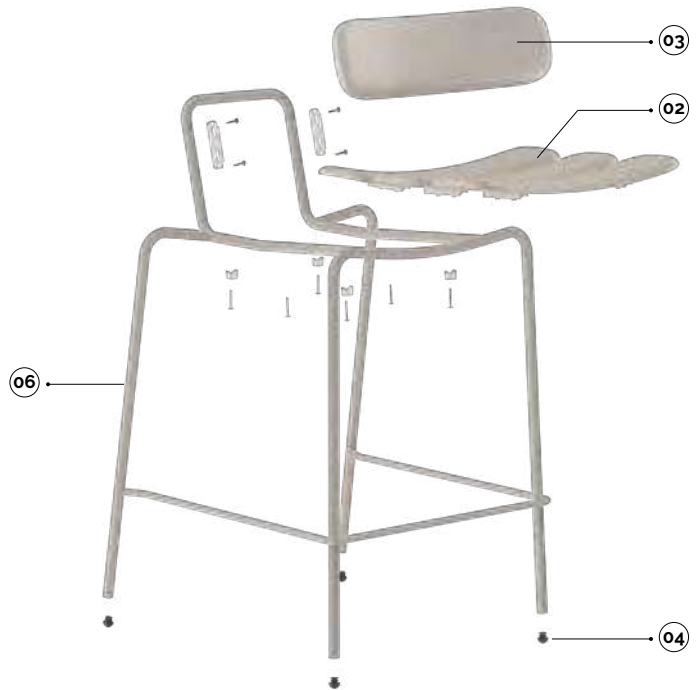

plastic colours

- noir/negro
- ivoire/marfil
- gris/gris
- jaune/amarillo
- vert/verde
- rouge/rojo

main component sizes

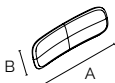
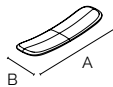
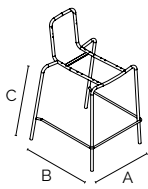

06 02 03 04

06 lemon - châssis tabouret h650 d.18 sans embouts

lemon - estructura taburete h650 d.18 sin tapones

code	finishing	q.kit	q.pack	a	b	c	kg.x1	vol.x1
110603-705	● noir/negro*	x1	50	530	560	645	5,20	mc. 0,08
110605-705	● ivoire/marfil*	x1	50	530	560	645	5,20	mc. 0,08
110604-705	● gris/gris*	x1	50	530	560	645	5,20	mc. 0,08
110608-705	● jaune/amarillo*	x1	50	530	560	645	5,20	mc. 0,08
110616-705	● vert/verde*	x1	50	530	560	645	5,20	mc. 0,08
110602-705	● rouge/rojo*	x1	50	530	560	645	5,20	mc. 0,08
110610-705	● chromé/cromado**	x1	50	530	560	645	5,20	mc. 0,08

* outdoor/indoor
** indoor

02 lemon - latte en plastique pour assise + vis + entretoises

lemon - duela de asiento de plástico + tornillos + parachoques

code	finishing	q.kit	q.pack	a	b	kg.x1	vol.x1
132203-110	● noir/negro	x3	30	460	135	0,35	mc. 0.002706
132205-110	● ivoire/marfil	x3	30	460	135	0,35	mc. 0.002706
132204-110	● gris/gris	x3	30	460	135	0,35	mc. 0.002706
132208-110	● jaune/amarillo	x3	30	460	135	0,35	mc. 0.002706
132216-110	● vert/verde	x3	30	460	135	0,35	mc. 0.002706
132202-110	● rouge/rojo	x3	30	460	135	0,35	mc. 0.002706

03 lemon - latte en plastique pour dossier + inserts + vis

lemon - duela de respaldo de plástico + insertos + tornillos

code	finishing	q.kit	q.pack	a	b	kg.x1	vol.x1
132103-110	● noir/negro	x1	20	460	135	0,35	mc. 0.004059
132105-110	● ivoire/marfil	x1	20	460	135	0,35	mc. 0.004059
132104-110	● gris/gris	x1	20	460	135	0,35	mc. 0.004059
132108-110	● jaune/amarillo	x1	20	460	135	0,35	mc. 0.004059
132116-110	● vert/verde	x1	20	460	135	0,35	mc. 0.004059
132102-110	● rouge/rojo	x1	20	460	135	0,35	mc. 0.004059

04 lemon - T118 - embout à ailettes tête sphérique d.18 noir

lemon - T118 - punta con aletas cabeza esférica d.18 negro

code	finishing	q.kit
134203-181	● noir/negro	x4

lemon

stool h.750



plastic colours

- noir/negro
- ivoire/marfil
- gris/gris
- jaune/amarillo
- vert/verde
- rouge/rojo

07 02 03 04

main component sizes

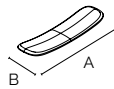
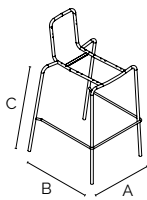

07

02



03

04

07 lemon - châssis tabouret h750 d.18 sans embouts lemon - estructura taburete h750 d.18 sin tapones

code	finishing	q.kit	q.pack	a	b	c	kg.x1	vol.x1
110603-712	● noir/negro*	x1	50	530	580	745	5.45	mc. 0.08
110605-712	● ivoire/marfil*	x1	50	530	580	745	5.45	mc. 0.08
110604-712	● gris/gris*	x1	50	530	580	745	5.45	mc. 0.08
110608-712	● jaune/amarillo*	x1	50	530	580	745	5.45	mc. 0.08
110616-712	● vert/verde*	x1	50	530	580	745	5.45	mc. 0.08
110602-712	● rouge/rojo*	x1	50	530	580	745	5.45	mc. 0.08
110610-712	● chromé/cromado**	x1	50	530	580	745	5.45	mc. 0.08

* outdoor/indoor
** indoor

02 lemon - latte en plastique pour assise + vis + entretoises lemon - duela de asiento de plástico + tornillos + parachoques

code	finishing	q.kit	q.pack	a	b	kg.x1	vol.x1
132203-110	● noir/negro	x3	30	460	135	0.35	mc. 0.002706
132205-110	● ivoire/marfil	x3	30	460	135	0.35	mc. 0.002706
132204-110	● gris/gris	x3	30	460	135	0.35	mc. 0.002706
132208-110	● jaune/amarillo	x3	30	460	135	0.35	mc. 0.002706
132216-110	● vert/verde	x3	30	460	135	0.35	mc. 0.002706
132202-110	● rouge/rojo	x3	30	460	135	0.35	mc. 0.002706

03 lemon - latte en plastique pour dossier + inserts + vis lemon - duela de respaldo de plástico + insertos + tornillos

code	finishing	q.kit	q.pack	a	b	kg.x1	vol.x1
132103-110	● noir/negro	x1	20	460	135	0.35	mc. 0.004059
132105-110	● ivoire/marfil	x1	20	460	135	0.35	mc. 0.004059
132104-110	● gris/gris	x1	20	460	135	0.35	mc. 0.004059
132108-110	● jaune/amarillo	x1	20	460	135	0.35	mc. 0.004059
132116-110	● vert/verde	x1	20	460	135	0.35	mc. 0.004059
132102-110	● rouge/rojo	x1	20	460	135	0.35	mc. 0.004059

04 lemon - T118 - embout à ailettes tête sphérique d.18 noir lemon - T118 - punta con aletas cabeza esférica d.18 negro

code	finishing	q.kit
134203-181	● noir/negro	x4

lemon

medium table



structure colours

- noir/negro
- ivoire/marfil
- gris/gris
- jaune/amarillo
- vert/verde
- rouge/rojo
- chromé/cromado

metal top colours

- noir/negro
- ivoire/marfil
- gris/gris
- jaune/amarillo
- vert/verde
- rouge/rojo

hpl top colours

- noir/negro
- ivoire/marfil

main component sizes

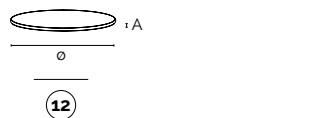
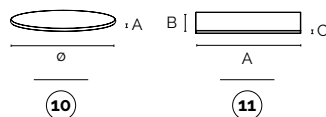
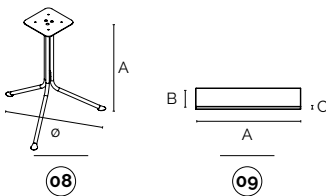

08 lemon - structure table moyenne fixe

lemon - estructura mesa baja fija

code	finishing	q.kit	q.pack	ø	a	kg.x1	vol.x1
110303-677	● noir/negro*	x1	1	745	730	4.50	mc. 0.0186
110305-677	● ivoire/marfil*	x1	1	745	730	4.50	mc. 0.0186
110304-677	● gris/gris*	x1	1	745	730	4.50	mc. 0.0186
110308-677	● jaune/amarillo*	x1	1	745	730	4.50	mc. 0.0186
110316-677	● vert/verde*	x1	1	745	730	4.50	mc. 0.0186
110302-677	● rouge/rojo*	x1	1	745	730	4.50	mc. 0.0186
110310-677	● chromé/cromado**	x1	1	745	730	4.50	mc. 0.0186

* outdoor/indoor
** indoor

09 lemon - plateau en métal carré 690x690

lemon - tapa metálica cuadrada 690x690

code	finishing	q.kit	q.pack	a	b	c	kg.x1	vol.x1
110303-697	● noir/negro*/***	x1	1	690	690	20	9.70	mc. 0.0098
110305-697	● ivoire/marfil*/***	x1	1	690	690	20	9.70	mc. 0.0098
110304-697	● gris/gris*/***	x1	1	690	690	20	9.70	mc. 0.0098
110308-697	● jaune/amarillo*/***	x1	1	690	690	20	9.70	mc. 0.0098
110316-697	● vert/verde*/***	x1	1	690	690	20	9.70	mc. 0.0098
110302-697	● rouge/rojo*/***	x1	1	690	690	20	9.70	mc. 0.0098

* outdoor/indoor

*** couleurs disponibles uniquement en quantités minimales de commande / colores disponibles sólo en cantidades minimas de pedido

10 lemon - plateau en métal rond ø700

lemon - tapa metálica redonda ø700

code	finishing	q.kit	q.pack	ø	a	kg.x1	vol.x1
110303-695	● noir/negro*/***	x1	1	700	20	7.70	mc. 0.0098
110305-695	● ivoire/marfil*/***	x1	1	700	20	7.70	mc. 0.0098
110304-695	● gris/gris*/***	x1	1	700	20	7.70	mc. 0.0098
110308-695	● jaune/amarillo*/***	x1	1	700	20	7.70	mc. 0.0098
110316-695	● vert/verde*/***	x1	1	700	20	7.70	mc. 0.0098
110302-695	● rouge/rojo*/***	x1	1	700	20	7.70	mc. 0.0098

* outdoor/indoor

*** couleurs disponibles uniquement en quantités minimales de commande / colores disponibles sólo en cantidades minimas de pedido

11 lemon - plateau en HPL carré 690x690

lemon - tapa de HPL cuadrada 690x690

code	finishing	q.kit	q.pack	a	b	c	kg.x1	vol.x1
120303-025	● noir/negro*	x1	1	690	690	10	7.80	mc. 0.0098
120305-025	● ivoire/marfil*	x1	1	690	690	10	7.80	mc. 0.0098

* outdoor/indoor

12 lemon - plateau en HPL rond ø690

lemon - tapa de HPL redonda ø690

code	finishing	q.kit	q.pack	ø	a	kg.x1	vol.x1
120303-022	● noir/negro*	x1	1	690	10	5.70	mc. 0.0098
120305-022	● ivoire/marfil*	x1	1	690	10	5.70	mc. 0.0098

* outdoor/indoor

lemon

high table

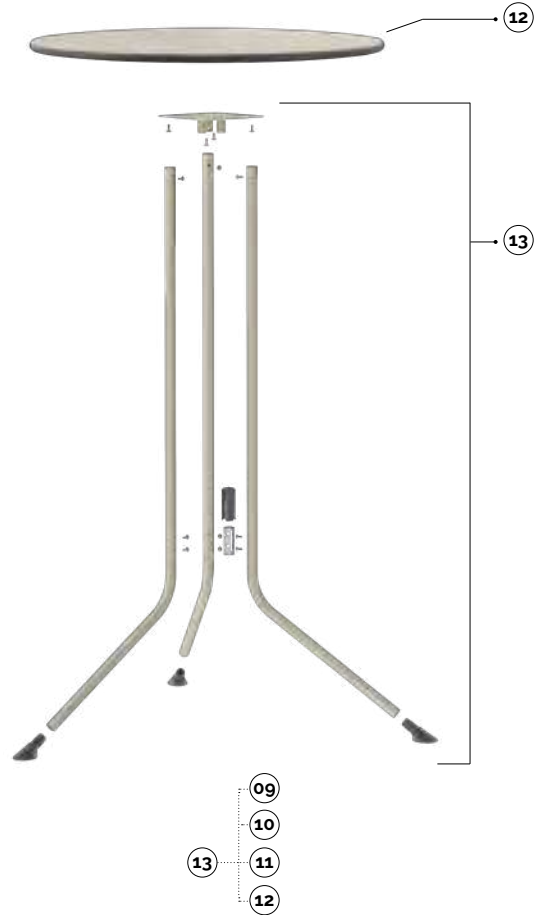
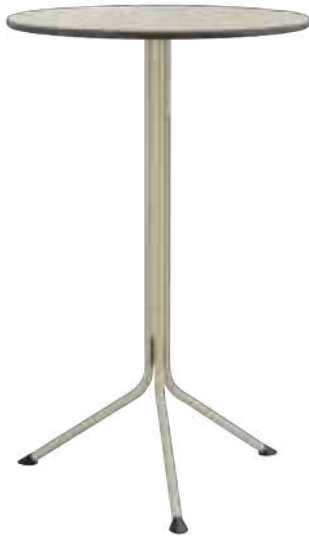

structure colours

- noir/negro
- ivoire/marfil
- gris/gris
- jaune/amarillo
- vert/verde
- rouge/rojo
- chromé/cromado

metal top colours

- noir/negro
- ivoire/marfil
- gris/gris
- jaune/amarillo
- vert/verde
- rouge/rojo

hpl top colours

- noir/negro
- ivoire/marfil

main component sizes

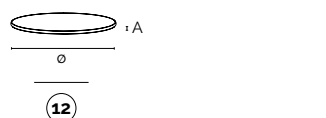
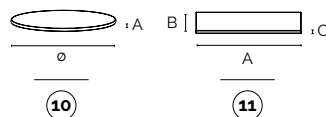
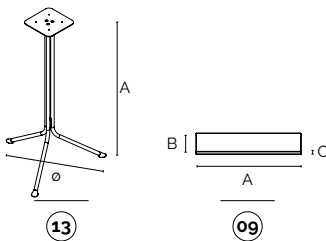

13 lemon - structure table haute fixe

lemon - estructura mesa alta fija

code	finishing	q.kit	q.pack	ø	a	kg.x1	vol.x1
110303-678	● noir/negro*	x1	1	745	1100	5,50	mc. 0,0272
110305-678	● ivoire/marfil*	x1	1	745	1100	5,50	mc. 0,0272
110304-678	● gris/gris*	x1	1	745	1100	5,50	mc. 0,0272
110308-678	● jaune/amarillo*	x1	1	745	1100	5,50	mc. 0,0272
110316-678	● vert/verde*	x1	1	745	1100	5,50	mc. 0,0272
110302-678	● rouge/rojo*	x1	1	745	1100	5,50	mc. 0,0272
110310-678	● chromé/cromado**	x1	1	745	1100	5,50	mc. 0,0272

* outdoor/indoor
** indoor

09 lemon - plateau en métal carré 690x690

lemon - tapa metálica cuadrada 690x690

code	finishing	q.kit	q.pack	a	b	c	kg.x1	vol.x1
110303-697	● noir/negro*/***	x1	1	690	690	20	9,70	mc. 0,0098
110305-697	● ivoire/marfil*/***	x1	1	690	690	20	9,70	mc. 0,0098
110304-697	● gris/gris*/***	x1	1	690	690	20	9,70	mc. 0,0098
110308-697	● jaune/amarillo*/***	x1	1	690	690	20	9,70	mc. 0,0098
110316-697	● vert/verde*/***	x1	1	690	690	20	9,70	mc. 0,0098
110302-697	● rouge/rojo*/***	x1	1	690	690	20	9,70	mc. 0,0098

* outdoor/indoor

*** couleurs disponibles uniquement en quantités minimales de commande / colores disponibles sólo en cantidades minimales de pedido

10 lemon - plateau en métal rond ø700

lemon - tapa metálica redonda ø700

code	finishing	q.kit	q.pack	ø	a	kg.x1	vol.x1
110303-695	● noir/negro*/***	x1	1	700	20	7,70	mc. 0,0098
110305-695	● ivoire/marfil*/***	x1	1	700	20	7,70	mc. 0,0098
110304-695	● gris/gris*/***	x1	1	700	20	7,70	mc. 0,0098
110308-695	● jaune/amarillo*/***	x1	1	700	20	7,70	mc. 0,0098
110316-695	● vert/verde*/***	x1	1	700	20	7,70	mc. 0,0098
110302-695	● rouge/rojo*/***	x1	1	700	20	7,70	mc. 0,0098

* outdoor/indoor

*** couleurs disponibles uniquement en quantités minimales de commande / colores disponibles sólo en cantidades minimales de pedido

11 lemon - plateau en HPL carré 690x690

lemon - tapa de HPL cuadrada 690x690

code	finishing	q.kit	q.pack	a	b	c	kg.x1	vol.x1
120303-025	● noir/negro*	x1	1	690	690	10	7,80	mc. 0,0098
120305-025	● ivoire/marfil*	x1	1	690	690	10	7,80	mc. 0,0098

* outdoor/indoor

12 lemon - plateau en HPL rond ø690

lemon - tapa de HPL redonda ø690

code	finishing	q.kit	q.pack	ø	a	kg.x1	vol.x1
120303-022	● noir/negro*	x1	1	690	10	5,70	mc. 0,0098
120305-022	● ivoire/marfil*	x1	1	690	10	5,70	mc. 0,0098

* outdoor/indoor

lemon

tilting medium table



structure colours

- noir/negro
- ivoire/marfil
- gris/gris
- jaune/amarillo
- vert/verde
- rouge/rojo
- chromé/cromado

metal top colours

- noir/negro
- ivoire/marfil
- gris/gris
- jaune/amarillo
- vert/verde
- rouge/rojo

hpl top colours

- noir/negro
- ivoire/marfil

main component sizes

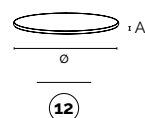
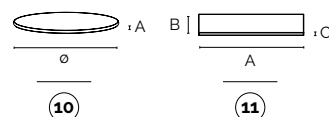
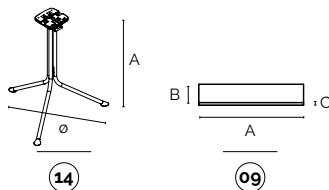

14 lemon - structure table moyenne rabattable

lemon - estructura mesa baja abatible

code	finishing	q.kit	q.pack	ø	a	kg.x1	vol.x1
110303-675	● noir/negro*	x1	1	745	730	4.30	mc. 0.0186
110305-675	● ivoire/marfil*	x1	1	745	730	4.30	mc. 0.0186
110304-675	● gris/gris*	x1	1	745	730	4.30	mc. 0.0186
110308-675	● jaune/amarillo*	x1	1	745	730	4.30	mc. 0.0186
110316-675	● vert/verde*	x1	1	745	730	4.30	mc. 0.0186
110302-675	● rouge/rojo*	x1	1	745	730	4.30	mc. 0.0186
110310-675	● chromé/cromado**	x1	1	745	730	4.30	mc. 0.0186

* outdoor/indoor
** indoor

09 lemon - plateau en métal carré 690x690

lemon - tapa metálica cuadrada 690x690

code	finishing	q.kit	q.pack	a	b	c	kg.x1	vol.x1
110303-697	● noir/negro*/***	x1	1	690	690	20	9.70	mc. 0.0098
110305-697	● ivoire/marfil*/***	x1	1	690	690	20	9.70	mc. 0.0098
110304-697	● gris/gris*/***	x1	1	690	690	20	9.70	mc. 0.0098
110308-697	● jaune/amarillo*/***	x1	1	690	690	20	9.70	mc. 0.0098
110316-697	● vert/verde*/***	x1	1	690	690	20	9.70	mc. 0.0098
110302-697	● rouge/rojo*/***	x1	1	690	690	20	9.70	mc. 0.0098

* outdoor/indoor

*** couleurs disponibles uniquement en quantités minimales de commande / colores disponibles sólo en cantidades minimas de pedido

10 lemon - plateau en métal rond ø700

lemon - tapa metálica redonda ø700

code	finishing	q.kit	q.pack	ø	a	kg.x1	vol.x1
110303-695	● noir/negro*/***	x1	1	700	20	7.70	mc. 0.0098
110305-695	● ivoire/marfil*/***	x1	1	700	20	7.70	mc. 0.0098
110304-695	● gris/gris*/***	x1	1	700	20	7.70	mc. 0.0098
110308-695	● jaune/amarillo*/***	x1	1	700	20	7.70	mc. 0.0098
110316-695	● vert/verde*/***	x1	1	700	20	7.70	mc. 0.0098
110302-695	● rouge/rojo*/***	x1	1	700	20	7.70	mc. 0.0098

* outdoor/indoor

*** couleurs disponibles uniquement en quantités minimales de commande / colores disponibles sólo en cantidades minimas de pedido

11 lemon - plateau en HPL carré 690x690

lemon - tapa de HPL cuadrada 690x690

code	finishing	q.kit	q.pack	a	b	c	kg.x1	vol.x1
120303-025	● noir/negro*	x1	1	690	690	10	7.80	mc. 0.0098
120305-025	● ivoire/marfil*	x1	1	690	690	10	7.80	mc. 0.0098

* outdoor/indoor

12 lemon - plateau en HPL rond ø690

lemon - tapa de HPL redonda ø690

code	finishing	q.kit	q.pack	ø	a	kg.x1	vol.x1
120303-022	● noir/negro*	x1	1	690	10	5.70	mc. 0.0098
120305-022	● ivoire/marfil*	x1	1	690	10	5.70	mc. 0.0098

* outdoor/indoor

15 lemon - kit poignée + 2 accroches en plastique noirs (pour table rabattable)

lemon - bolsa manija + 2 ganchos de plástico negros (para mesa abatible)

code	finishing	q.kit	q.pack
130303-025	● noir/negro*	x1	1

16 lemon - plaque pour kit poignée + accroches avec plateau en métal

lemon - placa para bolsa manija + ganchos con tapa metálica

code	finishing	q.kit	q.pack
113003-140	● noir/negro*	x1	10

lemon

tilting high table

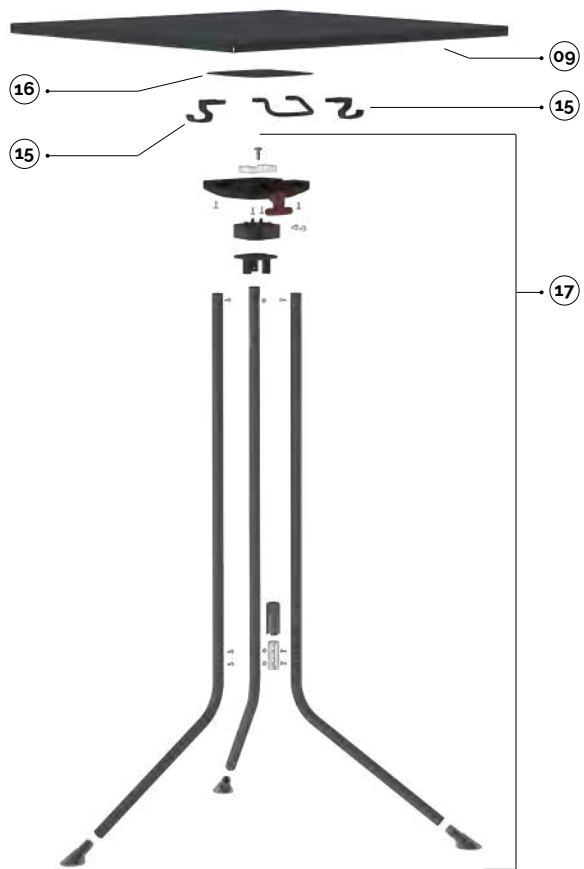

• structure colours

- noir/negro
- ivoire/marfil
- gris/gris
- jaune/amarillo
- vert/verde
- rouge/rojo
- chromé/cromado

• metal top colours

- noir/negro
- ivoire/marfil
- gris/gris
- jaune/amarillo
- vert/verde
- rouge/rojo

• hpl top colours

- noir/negro
- ivoire/marfil

• main component sizes

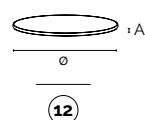
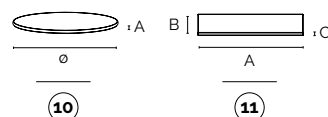
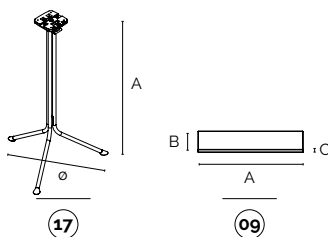

17 lemon - structure table haute rabattable

lemon - estructura mesa alta abatible

code	finishing	q.kit	q.pack	ø	a	kg.x1	vol.x1
110303-676	● noir/negro*	x1	1	745	1100	5.30	mc. 0.0272
110305-676	● ivoire/marfil*	x1	1	745	1100	5.30	mc. 0.0272
110304-676	● gris/gris*	x1	1	745	1100	5.30	mc. 0.0272
110308-676	● jaune/amarillo*	x1	1	745	1100	5.30	mc. 0.0272
110316-676	● vert/verde*	x1	1	745	1100	5.30	mc. 0.0272
110302-676	● rouge/rojo*	x1	1	745	1100	5.30	mc. 0.0272
110310-676	● chromé/cromado**	x1	1	745	1100	5.30	mc. 0.0272

* outdoor/indoor
** indoor

09 lemon - plateau en métal carré 690x690

lemon - tapa metálica cuadrada 690x690

code	finishing	q.kit	q.pack	a	b	c	kg.x1	vol.x1
110303-697	● noir/negro'/'**	x1	1	690	690	20	9.70	mc. 0.0098
110305-697	● ivoire/marfil'/'**	x1	1	690	690	20	9.70	mc. 0.0098
110304-697	● gris/gris'/'**	x1	1	690	690	20	9.70	mc. 0.0098
110308-697	● jaune/amarillo'/'**	x1	1	690	690	20	9.70	mc. 0.0098
110316-697	● vert/verde'/'**	x1	1	690	690	20	9.70	mc. 0.0098
110302-697	● rouge/rojo'/'**	x1	1	690	690	20	9.70	mc. 0.0098

* outdoor/indoor

** couleurs disponibles uniquement en quantités minimales de commande / colores disponibles sólo en cantidades minimales de pedido

10 lemon - plateau en métal rond ø700

lemon - tapa metálica redonda ø700

code	finishing	q.kit	q.pack	ø	a	kg.x1	vol.x1
110303-695	● noir/negro'/'**	x1	1	700	20	7.70	mc. 0.0098
110305-695	● ivoire/marfil'/'**	x1	1	700	20	7.70	mc. 0.0098
110304-695	● gris/gris'/'**	x1	1	700	20	7.70	mc. 0.0098
110308-695	● jaune/amarillo'/'**	x1	1	700	20	7.70	mc. 0.0098
110316-695	● vert/verde'/'**	x1	1	700	20	7.70	mc. 0.0098
110302-695	● rouge/rojo'/'**	x1	1	700	20	7.70	mc. 0.0098

* outdoor/indoor

** couleurs disponibles uniquement en quantités minimales de commande / colores disponibles sólo en cantidades minimales de pedido

11 lemon - plateau en HPL carré 690x690

lemon - tapa de HPL cuadrada 690x690

code	finishing	q.kit	q.pack	a	b	c	kg.x1	vol.x1
120303-025	● noir/negro*	x1	1	690	690	10	7.80	mc. 0.0098
120305-025	● ivoire/marfil*	x1	1	690	690	10	7.80	mc. 0.0098

* outdoor/indoor

12 lemon - plateau en HPL rond ø690

lemon - tapa de HPL redonda ø690

code	finishing	q.kit	q.pack	ø	a	kg.x1	vol.x1
120303-022	● noir/negro*	x1	1	690	10	5.70	mc. 0.0098
120305-022	● ivoire/marfil*	x1	1	690	10	5.70	mc. 0.0098

* outdoor/indoor

for the components below, see previous pages

15 16

lemon

rectangular medium table



structure colours

- noir/negro
- ivoire/marfil
- gris/gris
- jaune/amarillo
- vert/verde
- rouge/rojo
- chromé/cromado

metal top colours

- noir/negro
- ivoire/marfil
- gris/gris
- jaune/amarillo
- vert/verde
- rouge/rojo

hpl top colours

- noir/negro
- ivoire/marfil

main component sizes

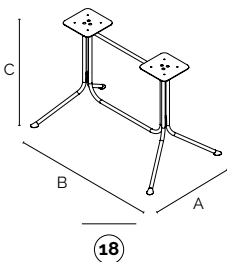

18

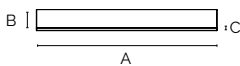

19 20

18 lemon - kit structure table moyenne fixe rectangulaire
lemon - kit estructura mesa baja fija rectangular

code	finishing	q.kit	q.pack	a	b	c	kg.x1	vol.x1
110303-679	● noir/negro*	x1	1	650	1070	730	9.45	mc. 0.025
110305-679	● ivoire/marfil*	x1	1	650	1070	730	9.45	mc. 0.025
110304-679	● gris/gris*	x1	1	650	1070	730	9.45	mc. 0.025
110308-679	● jaune/amarillo*	x1	1	650	1070	730	9.45	mc. 0.025
110316-679	● vert/verde*	x1	1	650	1070	730	9.45	mc. 0.025
110302-679	● rouge/rojo*	x1	1	650	1070	730	9.45	mc. 0.025
110310-679	● chromé/cromado**	x1	1	650	1070	730	9.45	mc. 0.025

* outdoor/indoor
** indoor

19 lemon - plateau en métal rectangulaire 1190x690
lemon - tapa metálica rectangular 1190x690

code	finishing	q.kit	q.pack	a	b	c	kg.x1	vol.x1
110303-698	● noir/negro*/***	x1	1	1190	690	20	17.80	mc. 0.0168
110305-698	● ivoire/marfil*/***	x1	1	1190	690	20	17.80	mc. 0.0168
110304-698	● gris/gris*/***	x1	1	1190	690	20	17.80	mc. 0.0168
110308-698	● jaune/amarillo*/***	x1	1	1190	690	20	17.80	mc. 0.0168
110316-698	● vert/verde*/***	x1	1	1190	690	20	17.80	mc. 0.0168
110302-698	● rouge/rojo*/***	x1	1	1190	690	20	17.80	mc. 0.0168

* outdoor/indoor

*** couleurs disponibles uniquement en quantités minimales de commande / colores disponibles sólo en cantidades minimas de pedido

20 lemon - plateau en HPL rectangulaire 1190x690
lemon - tapa de HPL rectangular 1190x690

code	finishing	q.kit	q.pack	a	b	c	kg.x1	vol.x1
120303-020	● noir/negro*	x1	1	1190	690	10	13.5	mc. 0.0168
120305-020	● ivoire/marfil*	x1	1	1190	690	10	13.5	mc. 0.0168

* outdoor/indoor

lemon

rectangular medium table



structure colours

- noir/negro
- ivoire/marfil
- gris/gris
- jaune/amarillo
- vert/verde
- rouge/rojo
- chromé/cromado

metal top colours

- noir/negro
- ivoire/marfil
- gris/gris
- jaune/amarillo
- vert/verde
- rouge/rojo

hpl top colours

- noir/negro
- ivoire/marfil

main component sizes

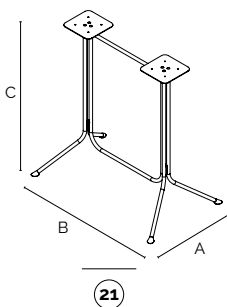

21



19 20

21 lemon - kit structure table haute fixe rectangulaire lemon - kit estructura mesa alta fija rectangular

code	finishing	q.kit	q.pack	a	b	c	kg.x1	vol.x1
110303-686	● noir/negro*	x1	1	650	1070	1100	11,57	mc. 0,037
110305-686	● ivoire/marfil*	x1	1	650	1070	1100	11,57	mc. 0,037
110304-686	● gris/gris*	x1	1	650	1070	1100	11,57	mc. 0,037
110308-686	● jaune/amarillo*	x1	1	650	1070	1100	11,57	mc. 0,037
110316-686	● vert/verde*	x1	1	650	1070	1100	11,57	mc. 0,037
110302-686	● rouge/rojo*	x1	1	650	1070	1100	11,57	mc. 0,037
110310-686	● chromé/cromado**	x1	1	650	1070	1100	11,57	mc. 0,037

* outdoor/indoor

** indoor

19 lemon - plateau en métal rectangulaire 1190x690 lemon - tapa metálica rectangular 1190x690

code	finishing	q.kit	q.pack	a	b	c	kg.x1	vol.x1
110303-698	● noir/negro*/***	x1	1	1190	690	20	17,80	mc. 0,0168
110305-698	● ivoire/marfil*/***	x1	1	1190	690	20	17,80	mc. 0,0168
110304-698	● gris/gris*/***	x1	1	1190	690	20	17,80	mc. 0,0168
110308-698	● jaune/amarillo*/***	x1	1	1190	690	20	17,80	mc. 0,0168
110316-698	● vert/verde*/***	x1	1	1190	690	20	17,80	mc. 0,0168
110302-698	● rouge/rojo*/***	x1	1	1190	690	20	17,80	mc. 0,0168

* outdoor/indoor

*** couleurs disponibles uniquement en quantités minimales de commande / colores disponibles sólo en cantidades minimales de pedido

20 lemon - plateau en HPL rectangulaire 1190x690 lemon - tapa de HPL rectangular 1190x690

code	finishing	q.kit	q.pack	a	b	c	kg.x1	vol.x1
120303-020	● noir/negro*	x1	1	1190	690	10	13,5	mc. 0,0168
120305-020	● ivoire/marfil*	x1	1	1190	690	10	13,5	mc. 0,0168

* outdoor/indoor

lemon

coffee table

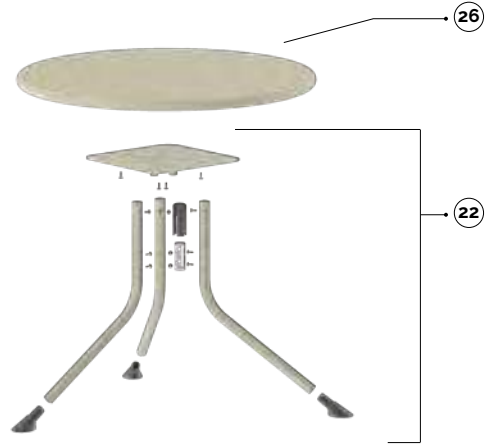

structure colours

- noir/negro
- ivoire/marfil
- gris/gris
- jaune/amarillo
- vert/verde
- rouge/rojo
- chromé/cromado

metal top colours

- noir/negro
- ivoire/marfil
- gris/gris
- jaune/amarillo
- vert/verde
- rouge/rojo

hpl top colours

- noir/negro
- ivoire/marfil

main component sizes

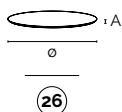
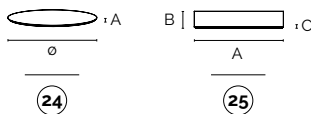
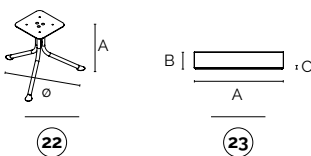

22 lemon - structure table basse fixe lemon - estructura mesa baja fija

code	finishing	q.kit	q.pack	ø	a	kg.x1	vol.x1
110303-726	● noir/negro*	x1	2	590	390	3,50	mc. 0.0093
110305-726	● ivoire/marfil*	x1	2	590	390	3,50	mc. 0.0093
110304-726	● gris/gris*	x1	2	590	390	3,50	mc. 0.0093
110308-726	● jaune/amarillo*	x1	2	590	390	3,50	mc. 0.0093
110316-726	● vert/verde*	x1	2	590	390	3,50	mc. 0.0093
110302-726	● rouge/rojo*	x1	2	590	390	3,50	mc. 0.0093
110310-726	● chromé/cromado**	x1	2	590	390	3,50	mc. 0.0093

* outdoor/indoor
** indoor

23 lemon - plateau en métal carré 590x590 lemon - tapa metálica cuadrada 590x590

code	finishing	q.kit	q.pack	a	b	c	kg.x1	vol.x1
110303-696	● noir/negro*/***	x1	1	590	590	20	7,45	mc. 0.0072
110305-696	● ivoire/marfil*/***	x1	1	590	590	20	7,45	mc. 0.0072
110304-696	● gris/gris*/***	x1	1	590	590	20	7,45	mc. 0.0072
110308-696	● jaune/amarillo*/***	x1	1	590	590	20	7,45	mc. 0.0072
110316-696	● vert/verde*/***	x1	1	590	590	20	7,45	mc. 0.0072
110302-696	● rouge/rojo*/***	x1	1	590	590	20	7,45	mc. 0.0072

* outdoor/indoor

*** couleurs disponibles uniquement en quantités minimales de commande / colores disponibles sólo en cantidades minimas de pedido

24 lemon - plateau en métal rond ø600 lemon - tapa metálica redonda ø600

code	finishing	q.kit	q.pack	ø	a	kg.x1	vol.x1
110303-694	● noir/negro*/***	x1	1	600	20	5,80	mc. 0.0072
110305-694	● ivoire/marfil*/***	x1	1	600	20	5,80	mc. 0.0072
110304-694	● gris/gris*/***	x1	1	600	20	5,80	mc. 0.0072
110308-694	● jaune/amarillo*/***	x1	1	600	20	5,80	mc. 0.0072
110316-694	● vert/verde*/***	x1	1	600	20	5,80	mc. 0.0072
110302-694	● rouge/rojo*/***	x1	1	600	20	5,80	mc. 0.0072

* outdoor/indoor

*** couleurs disponibles uniquement en quantités minimales de commande / colores disponibles sólo en cantidades minimas de pedido

25 lemon - plateau en HPL carré 590x590 lemon - tapa de HPL cuadrada 590x590

code	finishing	q.kit	q.pack	a	b	c	kg.x1	vol.x1
120303-024	● noir/negro*	x1	1	590	590	10	5,70	mc. 0.0072
120305-024	● ivoire/marfil*	x1	1	590	590	10	5,70	mc. 0.0072

* outdoor/indoor

26 lemon - plateau en HPL rond ø590 lemon - tapa de HPL redonda ø590

code	finishing	q.kit	q.pack	ø	a	kg.x1	vol.x1
120303-021	● noir/negro*	x1	1	590	10	4,00	mc. 0.0072
120305-021	● ivoire/marfil*	x1	1	590	10	4,00	mc. 0.0072

* outdoor/indoor





xylo



discover more about
Xylo Collection

Une collection de chaises et de tabourets avec coque monobloc en bois de hêtre ou en chêne plaqué, reposant sur une large gamme de châssis en métal, allant de la classique structure à quatre pieds, à la base polyvalente à 4 branches sur roulettes, jusqu'à la version pour banquette.

La relation entre le bois et le métal fait de la collection de sièges Xylo une solution d'aménagement intemporelle, capable de trouver facilement sa place dans tout type d'environnement, des espaces de restauration collectifs aux contextes domestiques.

Una colección de sillas y taburetes con carcasa en madera de haya o roble, apoyada sobre una amplia gama de estructuras metálicas, desde la clásica de 4 patas y la base versátil de 4 radios con ruedas, hasta la versión de banco.

La combinación de madera y metal convierte la colección de asientos Xylo en una solución de mobiliario atemporal, que puede encontrar fácilmente su lugar en cualquier tipo de entorno, desde zonas de restauración colectiva hasta contextos domésticos.

Plus

- Large assortiment de châssis et de bases.
- Certification EN 16139:2013+AC2013 Niveau 1.
- Coque rembourrable.
- Amplio surtido de estructuras y bases.
- Certificación EN 16139:2013+AC2013 Nivel 1.
- Carcasa tapizable.



designed by:
Stefano Bettio



**certified
product**



**trolley
available**

xylo

4-legs

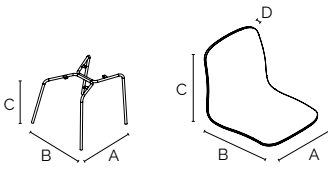
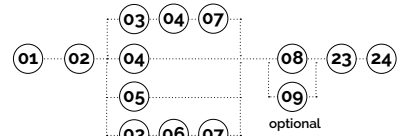
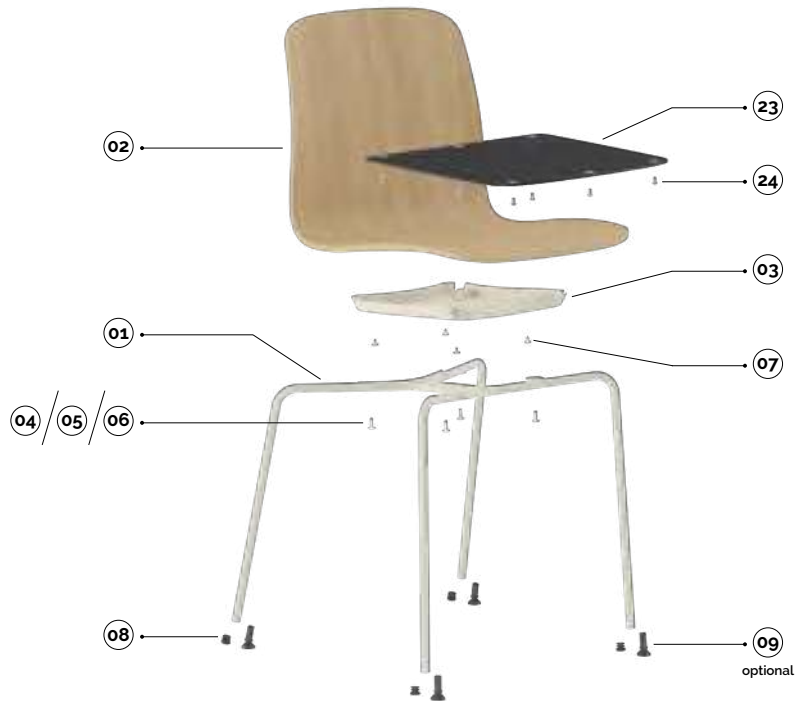
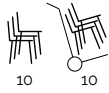

01

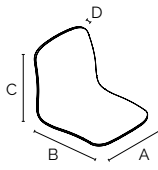

02

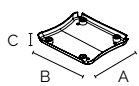

03



04



05



06

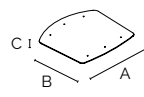

07



08



08



09



22 xylo - chariot porte-chaises avec accessoires
xylo - carro para sillas con accesorios

code	finishing	q.kit
110803-448	● noir/negro	x1

01 xylo - châssis 4 pieds d.16 sans embouts
xylo - estructura de 4 patas d.16 sin tapones

code	finishing	q.kit	q.pack	a	b	c	kg.x1	vol.x1
110103-464	● noir/negro	x1	200	535	505	455	2.00	mc. 0.02
110105-464	● ivoire/marfil	x1	200	535	505	455	2.00	mc. 0.02
110110-464	● chromé/cromado	x1	200	535	505	455	2.00	mc. 0.02

02 xylo - coque en bois pour châssis 4 pieds/luge/base fixe 4 branches/banquette
xylo - carcasa de madera para estructura de 4 patas /patin/ base fija de 4 brazos / banco

code	finishing	q.kit	q.pack	a	b	c	d	kg.x1	vol.x1
123907-004	● hêtre/haya	x1	5	440	510	410	12	3.00	mc. 0.0312
123907-006	● chêne/roble	x1	5	440	510	410	12	3.00	mc. 0.0312
123901-000	● brut à tapisser/en brut pour tapisar	x1	5	440	510	410	12	3.00	mc. 0.0312

03 xylo - couverture en plastique
xylo - cubierta de plástico

code	finishing	q.kit	q.pack	a	b	c	kg.x1	vol.x1
132203-043	● noir/negro	x1	10	260	310	30	0.25	mc. 0.0025
132205-040	● ivoire/marfil	x1						

04 xylo - vis m6x16 pour fixation coque hêtre/chêne avec couverture ou pour fixation coque à tapisser sans couverture
xylo - tornillo m6x16 para fijación de carcasa haya/roble con cubierta o para fijación de carcasa para tapizar sin cubierta

code	finishing	q.kit
117711-185	○ blanc zingué/blanco galvanizado	x4

05 xylo - vis TBEI m6x10 pour fixation coque hêtre/chêne sans couverture
xylo - tornillo TBEI m6x10 para fijación de carcasa haya/roble sin cubierta

code	finishing	q.kit
117711-540	○ blanc zingué/blanco galvanizado	x4

06 xylo - vis TBEI 10.9 M6x20 pour fixation coque à tapisser avec couverture
xylo - tornillo TBEI 10.9 M6x20 para fijación de carcasa para tapizar con cubierta

code	finishing	q.kit
117711-211	○ blanc zingué/blanco galvanizado	x4

07 xylo - entretoises en PVC avec tête bombée
xylo - parachoques de PVC con cabeza redondeada

code	finishing	q.kit
134406-000	○ neutre/neutro	x4

08 xylo - embout à ailettes rond d.16 noir
xylo - punta con aletas redonda d.16 negro

code	finishing	q.kit
134203-160	● noir/negro	x4

09 xylo - pied à inclinaison variable d.16 noir
xylo - pie basculante variable d.16 negro

code	finishing	q.kit
134203-163	● noir/negro	x4

for the components below, see next page

23 24

xylo

4-legs w/armrests

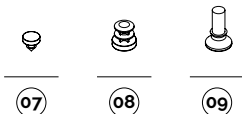
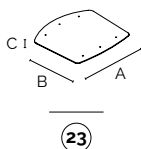
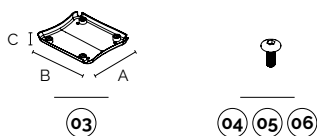
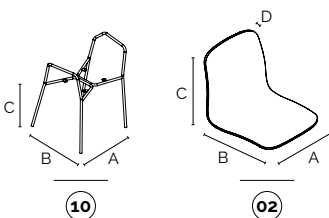
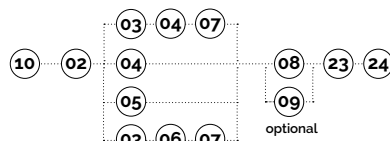
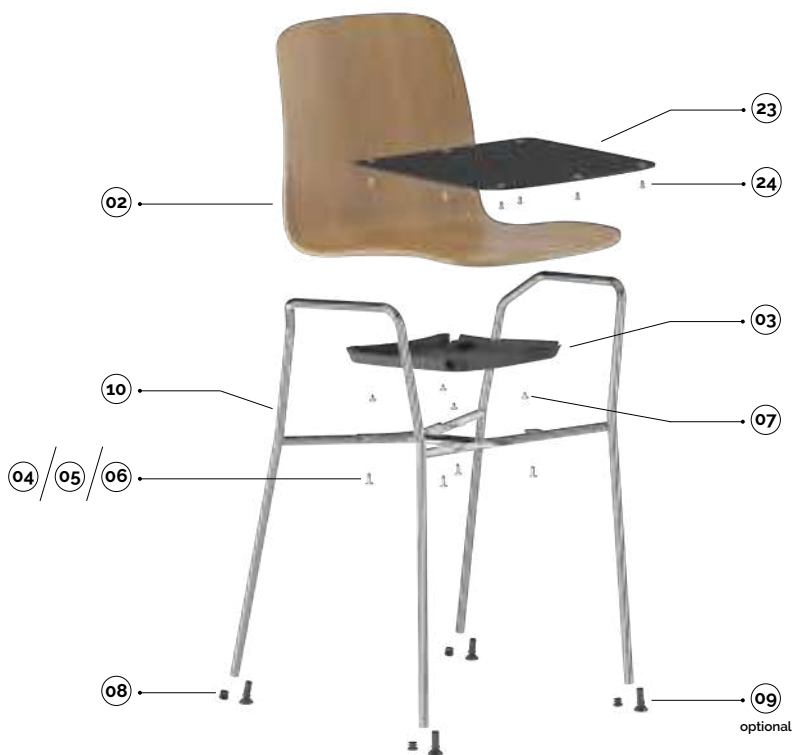
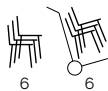

main component sizes

10 xylo - châssis 4 pieds avec accoudoirs d.16 sans embouts
xylo - estructura de 4 patas con reposabrazos d.16 sin tapones

code	finishing	q.kit	q.pack	a	b	c	kg.x1	vol.x1
110103-463	● noir/negro	x1	60	535	505	455	3.15	mc. 0.035
110105-463	● ivoire/marfil ral 1013	x1	60	535	505	455	3.15	mc. 0.035
110110-463	● chromé/cromado	x1	60	535	505	455	3.15	mc. 0.035

02 xylo - coque en bois pour châssis 4 pieds/luge/base fixe 4 branches/banquette
xylo - carcasa de madera para estructura de 4 patas /patin/ base fija de 4 brazos / banco

code	finishing	q.kit	q.pack	a	b	c	d	kg.x1	vol.x1
123907-004	● hêtre/haya	x1	5	440	510	410	12	3.00	mc. 0.0312
123907-006	● chêne/roble	x1	5	440	510	410	12	3.00	mc. 0.0312
123901-000	● brut à tapisser/en brut para tapizar	x1	5	440	510	410	12	3.00	mc. 0.0312

03 xylo - couverture en plastique
xylo - cubierta de plástico

code	finishing	q.kit	q.pack	a	b	c	kg.x1	vol.x1
132203-043	● noir/negro ral 9005	x1	10	260	310	30	0.25	mc. 0.0025
132205-040	● ivoire/marfil ral 1013	x1						

04 xylo - vis m6x16 pour fixation coque hêtre/chêne avec couverture ou pour fixation coque à tapisser sans couverture
xylo - tornillo m6x16 para fijación de carcasa haya/roble con cubierta o para fijación de carcasa para tapizar sin cubierta

code	finishing	q.kit
117711-185	○ blanc zingué/blanco galvanizado	x4

05 xylo - vis TBEI m6x10 pour fixation coque hêtre/chêne sans couverture
xylo - tornillo TBEI m6x10 para fijación de carcasa haya/roble sin cubierta

code	finishing	q.kit
117711-540	○ blanc zingué/blanco galvanizado	x4

06 xylo - vis TBEI 10.g M6x20 pour fixation coque à tapisser avec couverture
xylo - tornillo TBEI 10.g M6x20 para fijación de carcasa para tapizar con cubierta

code	finishing	q.kit
117711-211	○ blanc zingué/blanco galvanizado	x4

23 xylo - panneau de siège en plastique avec 6 goujons
xylo - panel de asiento de plástico con 6 clavos

code	finishing	q.kit	a	b	c	kg.x1
132203-095	● noir/negro	x1	413	387	4	0.60

24 xylo - vis pour la fixation du panneau
xylo - bolsa de tornillos para la fijación del panel

code	finishing	q.kit
117711-120	○ blanc zingué/blanco galvanizado	x6

for the components below, see previous page



xylo

stool h.650

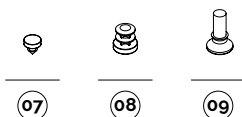
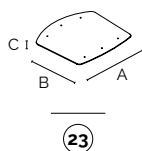
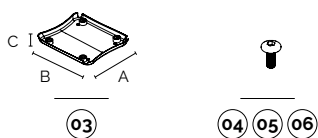
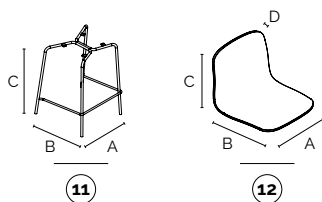
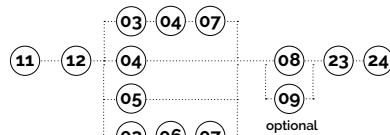
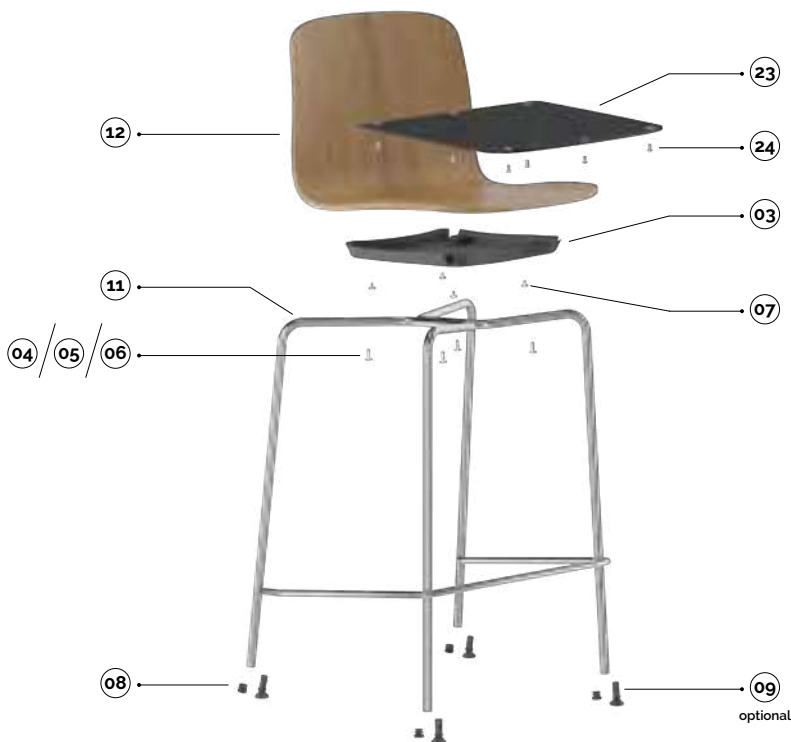

11 xylo - châssis tabouret h.650 d.16 sans embouts xylo - estructura de taburete h.650 d.16 sin tapones

code	finishing	q.kit	q.pack	a	b	c	kg.x1	vol.x1
110603-660	● noir/negro	x1	50	485	465	640	3,70	mc. 0.08
110605-660	● ivoire/marfil ral 1013	x1	50	485	465	640	3,70	mc. 0.08
110610-660	● chromé/cromado	x1	50	485	465	640	3,70	mc. 0.08

12 xylo - coque en bois pour châssis tabouret xylo - carcasa de madera para estructura de taburete

code	finishing	q.kit	q.pack	a	b	c	d	kg.x1	vol.x1
123907-005	● hêtre/haya	x1	5	410	420	340	12	2,30	mc. 0.0312
123907-007	● chêne/roble	x1	5	410	420	340	12	2,30	mc. 0.0312
123901-001	● brut à tapisser/en brut para tapizar	x1	5	410	420	340	12	2,30	mc. 0.0312

03 xylo - couverture en plastique xylo - cubierta de plástico

code	finishing	q.kit	q.pack	a	b	c	kg.x1	vol.x1
132203-043	● noir/negro ral 9005	x1	10	260	310	30	0,25	mc. 0.0025
132205-040	● ivoire/marfil ral 1013	x1						

04 xylo - vis m6x16 pour fixation coque hêtre/chêne avec couverture ou pour fixation coque à tapisser sans couverture xylo - tornillo m6x16 para fijación de carcasa haya/roble con cubierta o para fijación de carcasa para tapizar sin cubierta

code	finishing	q.kit
117711-185	○ blanc zingué/blanco galvanizado	x4

05 xylo - vis TBEI m6x10 pour fixation coque hêtre/chêne sans couverture xylo - tornillo TBEI m6x10 para fijación de carcasa haya/roble sin cubierta

code	finishing	q.kit
117711-540	○ blanc zingué/blanco galvanizado	x4

06 xylo - vis TBEI 10.9 M6x20 pour fixation coque à tapisser avec couverture xylo - tornillo TBEI 10.9 M6x20 para fijación de carcasa para tapizar con cubierta

code	finishing	q.kit
117711-211	○ blanc zingué/blanco galvanizado	x4

07 xylo - entretoises en PVC avec tête bombée xylo - parachoques de PVC con cabeza redondeada

code	finishing	q.kit
134406-000	○ neutre/neutro	x4

08 xylo - embout à ailettes rond d.16 noir xylo - punta con aletas redonda d.16 negro

code	finishing	q.kit
134203-160	● noir/negro	x4

09 xylo - pied à inclinaison variable d.16 noir xylo - pie basculante variable d.16 negro

code	finishing	q.kit
134203-163	● noir/negro	x4

for the components below, see next page



xylo

stool h.750

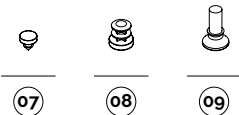
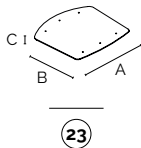
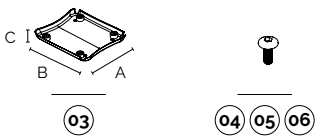
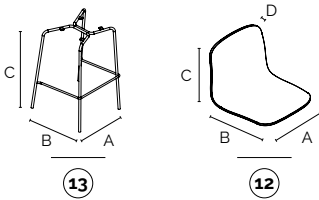
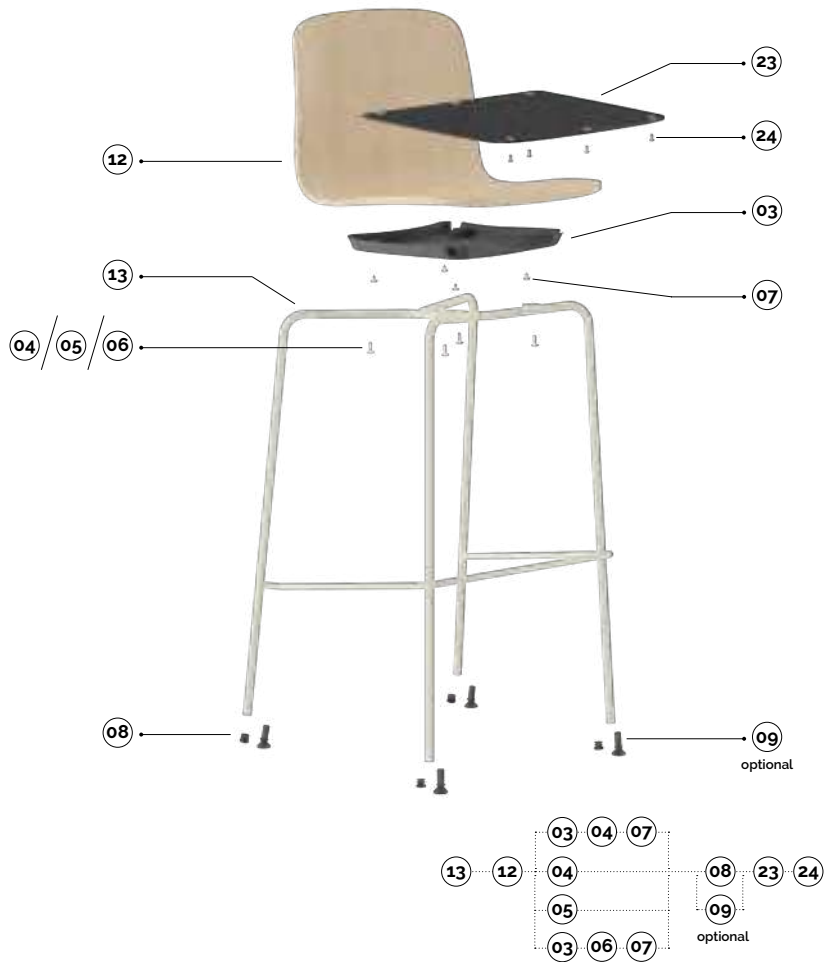

13 xylo - châssis tabouret h.750 d.16 sans embouts

xylo - estructura de taburete h.750 d.16 sin tapones

code	finishing	q.kit	q.pack	a	b	c	kg.x1	vol.x1
110603-666	● noir/negro	x1	50	490	480	740	3,90	mc. 0.08
110605-666	● ivoire/marfil	x1	50	490	480	740	3,90	mc. 0.08
110610-666	● chromé/cromado	x1	50	490	480	740	3,90	mc. 0.08

12 xylo - coque en bois pour châssis tabouret

xylo - carcasa de madera para estructura de taburete

code	finishing	q.kit	q.pack	a	b	c	d	kg.x1	vol.x1
123907-005	● hêtre/haya	x1	5	410	420	340	12	2,30	mc. 0.0312
123907-007	● chêne/roble	x1	5	410	420	340	12	2,30	mc. 0.0312
123901-001	● brut à tapisser/en brut pour tapizar	x1	5	410	420	340	12	2,30	mc. 0.0312

03 xylo - couverture en plastique

xylo - cubierta de plástico

code	finishing	q.kit	q.pack	a	b	c	kg.x1	vol.x1
132203-043	● noir/negro	x1	10	260	310	30	0,25	mc. 0.0025
132205-040	● ivoire/marfil	x1						

04 xylo - vis m6x16 pour fixation coque hêtre/chêne avec couverture ou pour fixation coque à tapisser sans couverture

xylo - tornillo m6x16 para fijación de carcasa haya/roble con cubierta o para fijación de carcasa para tapizar sin cubierta

code	finishing	q.kit
117711-185	○ blanc zingué/blanco galvanizado	x4

05 xylo - vis TBEI m6x10 pour fixation coque hêtre/chêne sans couverture

xylo - tornillo TBEI m6x10 para fijación de carcasa haya/roble sin cubierta

code	finishing	q.kit
117711-540	○ blanc zingué/blanco galvanizado	x4

06 xylo - vis TBEI 10.g M6x20 pour fixation coque à tapisser avec couverture

xylo - tornillo TBEI 10.g M6x20 para fijación de carcasa para tapizar con cubierta

code	finishing	q.kit
117711-211	○ blanc zingué/blanco galvanizado	x4

23 xylo - panneau de siège en plastique avec 6 goujons

xylo - panel de asiento de plástico con 6 clavos

code	finishing	q.kit	a	b	c	kg.x1
132203-095	● noir/negro	x1	413	387	4	0,60

24 xylo - vis pour la fixation du panneau

xylo - bolsa de tornillos para la fijación del panel

code	finishing	q.kit
117711-120	○ blanc zingué/blanco galvanizado	x6

for the components below, see previous page



xylo

slide

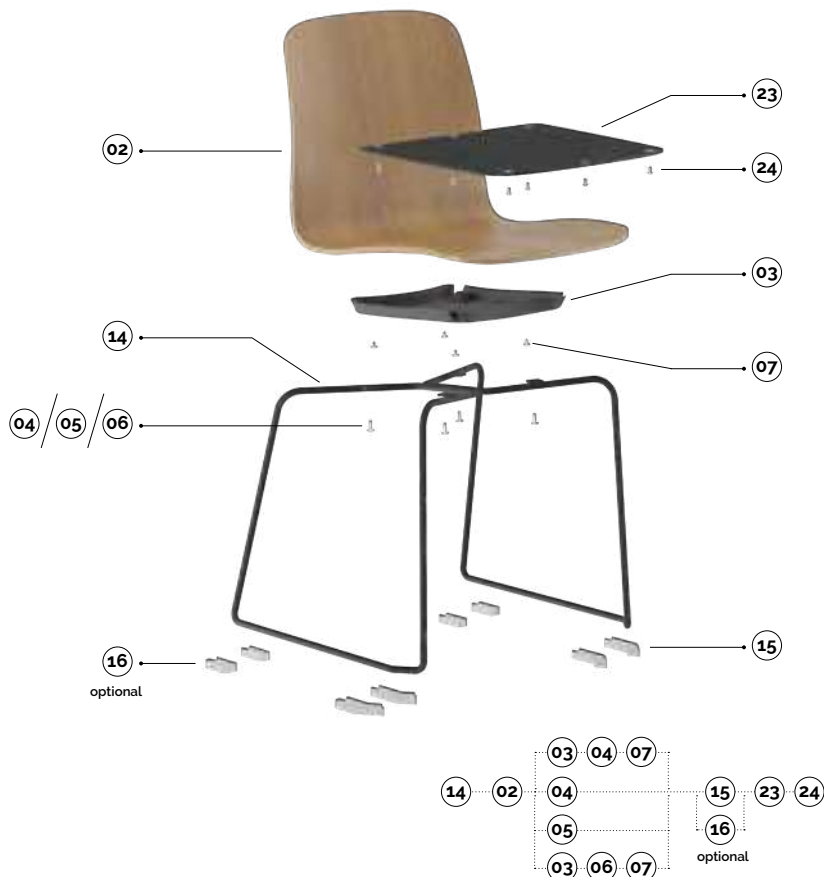
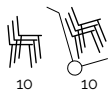

14 xylo - châssis luge en fil d'acier d.12
xylo - estructura de patin de varilla d.12

code	finishing	q.kit	q.pack	a	b	c	kg.x1	vol.x1
110503-549	● noir/negro	x1	100	555	495	455	3,70	mc.0.03
110505-549	● ivoire/marfil	ral 1013	x1	100	555	495	455	3,70
110510-549	● chromé/cromado		x1	100	555	495	455	3,70

02 xylo - coque en bois pour châssis 4 pieds/luge/base fixe 4 branches/banquette
xylo - carcasa de madera para estructura de 4 patas /patin/ base fija de 4 brazos /banco

code	finishing	q.kit	q.pack	a	b	c	d	kg.x1	vol.x1
123907-004	● hêtre/haya	x1	5	440	510	410	12	3,00	mc. 0.0312
123907-006	● chêne/roble	x1	5	440	510	410	12	3,00	mc. 0.0312
123901-000	● brut à tapisser/en brut para tapizar	x1	5	440	510	410	12	3,00	mc. 0.0312

03 xylo - couverture en plastique
xylo - cubierta de plástico

code	finishing	q.kit	q.pack	a	b	c	kg.x1	vol.x1
132203-043	● noir/negro	ral 9005	x1	10	260	310	30	0,25
132205-040	● ivoire/marfil	ral 1013	x1					

04 xylo - vis m6x16 pour fixation coque hêtre/chêne avec couverture ou pour fixation coque à tapisser sans couverture
xylo - tornillo m6x16 para fijación de carcasa haya/roble con cubierta o para fijación de carcasa para tapizar sin cubierta

code	finishing	q.kit
117711-185	○ blanc zingué/blanco galvanizado	x4

05 xylo - vis TBEI m6x10 pour fixation coque hêtre/chêne sans couverture
xylo - tornillo TBEI m6x10 para fijación de carcasa haya/roble sin cubierta

code	finishing	q.kit
117711-540	○ blanc zingué/blanco galvanizado	x4

06 xylo - vis TBEI 10.g M6x20 pour fixation coque à tapisser avec couverture
xylo - tornillo TBEI 10.g M6x20 para fijación de carcasa para tapizar con cubierta

code	finishing	q.kit
117711-211	○ blanc zingué/blanco galvanizado	x4

07 xylo - entretoises en PVC avec tête bombée
xylo - parachoques de PVC con cabeza redondeada

code	finishing	q.kit
134406-000	○ neutre/neutro	x4

15 xylo - BTF-kit de pieds
xylo - BTF-kit de pies

code	finishing	q.kit	q.pack
134306-001	○ neutre/neutro	x1	100

16 xylo - BTFA-kit de pieds avec accroches
xylo - BTFA-kit de pies con ganchos

code	finishing	q.kit	q.pack
134306-002	○ neutre/neutro	x1	100

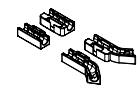
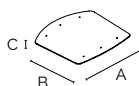
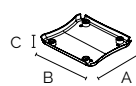
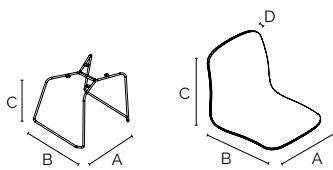

main component sizes

for the components below, see next page

23 **24**

xylo

4-spoke base

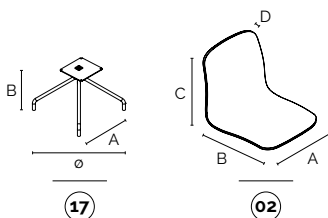
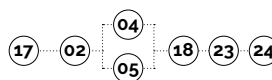
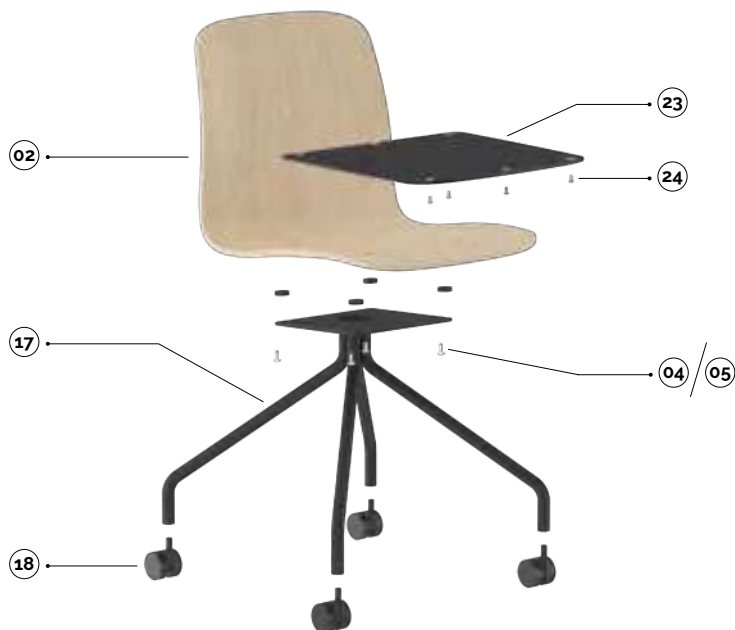

17

02



04 05



18

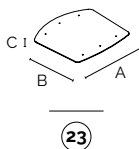

23

17 xylo - base fixe à 4 branches avec réducteurs pour roulettes + entretoises
xylo - base fija de 4 brazos con reductores para ruedas + separadores

code	finishing	q.kit	q.pack	ø	a	b	kg.x1	vol.x1
110203-165	● noir/negro	x1	30	680	490	380	4,00	mc. 0.1
110205-165	● ivoire/marfil	x1	30	680	490	380	4,00	mc. 0.1
110210-165	● chromé/cromado	x1	30	680	490	380	4,00	mc. 0.1

02 xylo - coque en bois pour châssis 4 pieds/luge/base fixe 4 branches/banquette

xylo - carcasa de madera para estructura de 4 patas /luge/ base fija de 4 brazos / banco

code	finishing	q.kit	q.pack	a	b	c	d	kg.x1	vol.x1
123907-004	● hêtre/haya	x1	5	440	510	410	12	3,00	mc. 0.0312
123907-006	● chêne/roble	x1	5	440	510	410	12	3,00	mc. 0.0312
123901-000	● brut à tapisser/en brut pour tapizar	x1	5	440	510	410	12	3,00	mc. 0.0312

04 xylo - vis m6x16 pour fixation coque hêtre/chêne avec couverture ou pour fixation coque à tapisser sans couverture

xylo - tornillo m6x16 para fijación de carcasa haya/roble con cubierta o para fijación de carcasa para tapizar sin cubierta

code	finishing	q.kit
117711-185	○ blanc zingué/blanco galvanizado	x4

05 xylo - vis TBEI m6x10 pour fixation coque hêtre/chêne sans couverture

xylo - tornillo TBEI m6x10 para fijación de carcasa haya/roble sin cubierta

code	finishing	q.kit
117711-540	○ blanc zingué/blanco galvanizado	x4

18 double roulette d.50 en desmopan avec goupille montée

doble rueda d.50 de desmopan con pivote montado

code	finishing	q.kit	kg.x1
134403-003	● noir/negro	x4	0,05

23 xylo - panneau de siège en plastique avec 6 goujons

xylo - panel de asiento de plástico con 6 clavos

code	finishing	q.kit	a	b	c	kg.x1
132203-095	● noir/negro	x1	413	387	4	0,60

24 xylo - vis pour la fixation du panneau

xylo - bolsa de tornillos para la fijación del panel

code	finishing	q.kit
117711-120	○ blanc zingué/blanco galvanizado	x6

xylo

bench

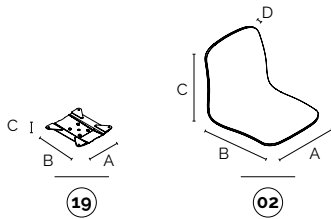
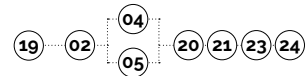
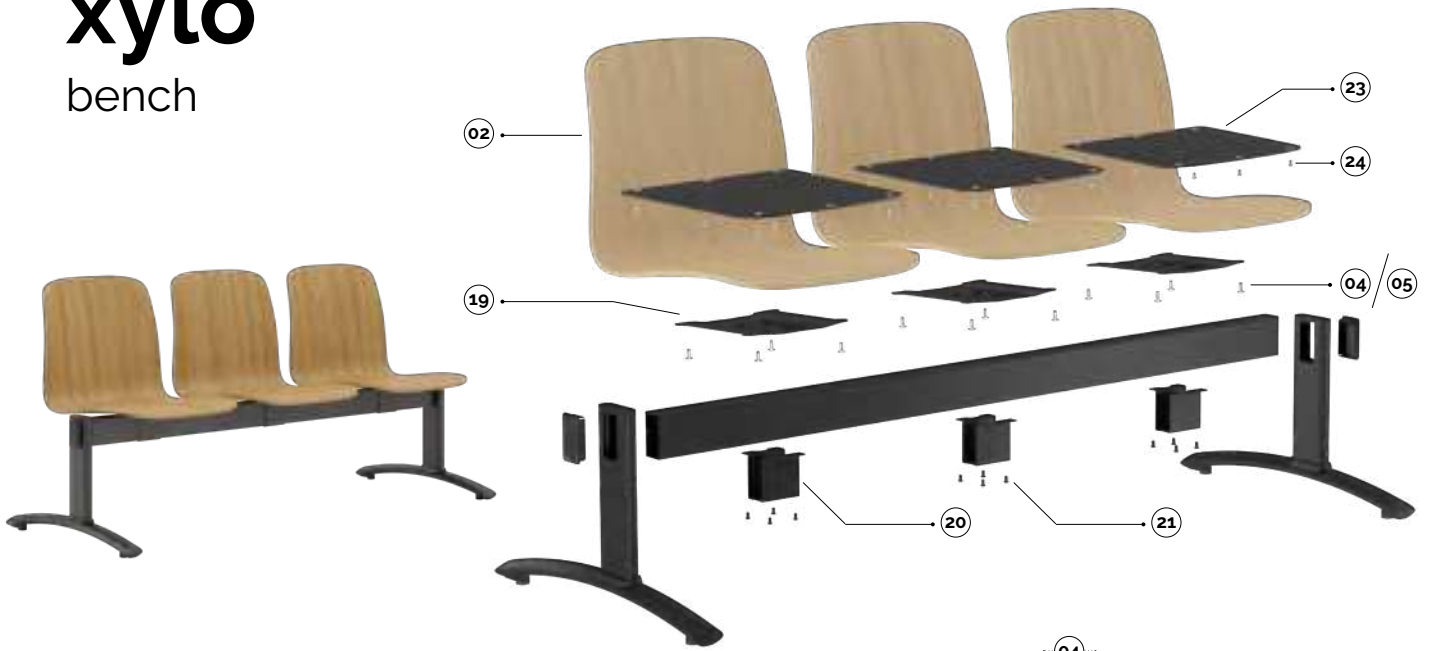

19

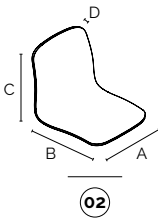

02

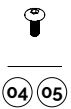

04 05



20



21

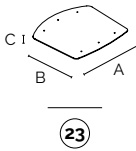

23

19 xylo - châssis de banquette peint
xylo - estructura de banco pintado

code	finishing	q.kit	q.pack	a	b	c	kg.x1	vol.x1
110703-606	● noir/negro	x1	10	225	225	20	1,05	mc. 0,002

02 xylo - coque en bois pour châssis 4 pieds/luge/base fixe 4 branches/banquette
xylo - carcasa de madera para estructura de 4 patas /patin/ base fija de 4 brazos / banco

code	finishing	q.kit	q.pack	a	b	c	d	kg.x1	vol.x1
123907-004	● hêtre/haya	x1	5	440	510	410	12	3,00	mc. 0,0312
123907-006	● chêne/roble	x1	5	440	510	410	12	3,00	mc. 0,0312
123901-000	● brut à tapisser/en brut pour tapizer	x1	5	440	510	410	12	3,00	mc. 0,0312

04 xylo - vis m6x16 pour fixation coque hêtre/chêne avec couverture ou pour fixation coque à tapisser sans couverture
xylo - tornillo m6x16 para fijación de carcasa haya/roble con cubierta o para fijación de carcasa para tapizar sin cubierta

code	finishing	q.kit
117711-185	○ blanc zingué/blanco galvanizado	x4

05 xylo - vis TBEI m6x10 pour fixation coque hêtre/chêne sans couverture
xylo - tornillo TBEI m6x10 para fijación de carcasa haya/roble sin cubierta

code	finishing	q.kit
117711-540	○ blanc zingué/blanco galvanizado	x4

20 xylo - support de poutre
xylo - soporte de viga

code	finishing	q.kit	q.pack	a	b	kg.x1	vol.x1
110703-007	● noir/negro	x1	50	55	65	0,60	mc. 0,0005

21 xylo - sac de vis à tête cylindrique M8x12
xylo - bolsa de tornillos M8x12 de cabeza cilindrica y hexágono empotrado

code	finishing	q.kit	q.pack
117003-070	● noir/negro	x4	200

23 xylo - panneau de siège en plastique avec 6 goujons
xylo - panel de asiento de plástico con 6 clavos

code	finishing	q.kit	a	b	c	kg.x1
132203-095	● noir/negro	x1	413	387	4	0,60

24 xylo - vis pour la fixation du panneau
xylo - bolsa de tornillos para la fijación del panel

code	finishing	q.kit
117711-120	○ blanc zingué/blanco galvanizado	x6

for the bench components, see page 417

main component sizes

optionals

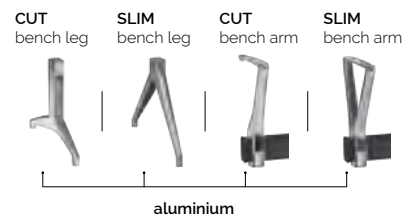
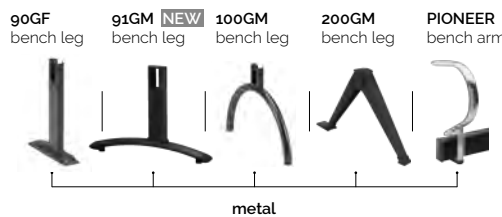





jota



discover more about
Jota Collection

Une collection de sièges pratiques et compacts, idéale pour le secteur contractuel, mais pas seulement. Jota comprend une chaise, disponible avec ou sans accoudoirs, et un tabouret, tous deux présentant un design distinctif et contemporain. Le langage de Jota s'adapte facilement à tout type d'environnement grâce à la variété des finitions et à la gamme de couleurs disponibles. Les coques, tant pour la chaise que pour le tabouret, sont fabriquées en technopolymère, disponible en 4 couleurs, ou en Bio-Lolla. De plus, il est possible de tapisser les coques d'assise et le panneau du dossier dédié afin d'obtenir une plus grande personnalisation.

Una colección de asientos práctica y compacta, ideal sobre todo para el sector contractual. Jota se compone de una silla, disponible con o sin reposabrazos, y un taburete, ambos con un diseño distintivo y contemporáneo. El estilo de Jota se adapta fácilmente a cualquier tipo de entorno gracias a la variedad de acabados y la gama de colores disponibles. Las carcasas son de tecnopolimero y están disponible en 4 colores o de Bio-Lolla, tanto para la silla como para el taburete. Además, es posible tapizar las carcasas del asiento y el panel específico del respaldo para lograr una mayor personalización.

Plus

- Disponible en versions chaise, chaise avec accoudoirs et tabouret.
- Possibilité de rembourrer le siège et le panneau du dossier dédié.
- Coques d'assise et de dossier fabriquées en matériau recyclé à base de coquilles de riz (Bio-Lolla).
- Disponible en versions de silla con y sin reposabrazos y taburete.
- Posibilidad de tapizar asiento y panel de respaldo específico.
- Carcasas de asiento y respaldo hechas de material reciclado a base de cáscaras de arroz (Bio-Lolla).



designed by:
Studio Irvine

jota

4-legs

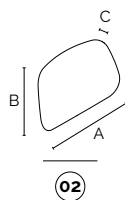
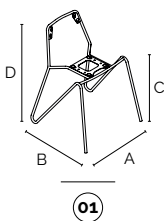
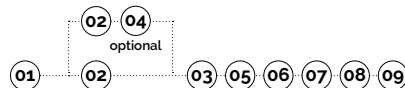
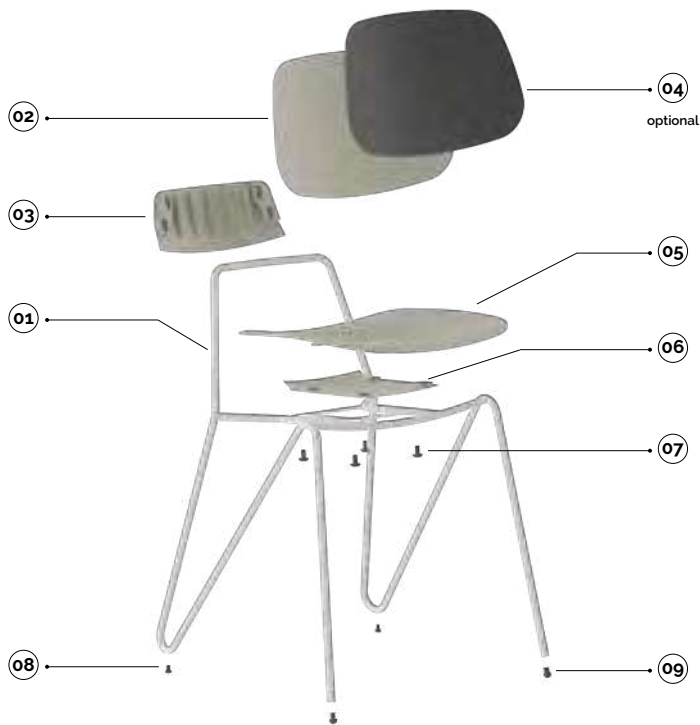

01

02

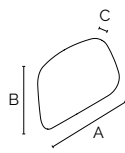
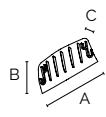

03

04

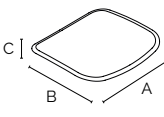

05

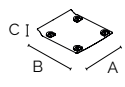

06



07



08



09

01 jota chaise - châssis à quatre pieds en métal
jota silla - estructura de 4 patas metálicas

code	finishing	q.kit	q.pack	a	b	c	d	kg.x1	vol.x1
A110103-072	● noir/negro	x1	40	500	500	458	680	3,25	/
A110105-072	● blanc/blanco	x1	40	500	500	458	680	3,25	/
A110110-072	● chromé/cromado	x1	40	500	500	458	680	3,25	/

02 jota chaise & tabouret - dossier en technopolymère
jota silla & taburete - respaldo de tecnopolimero

code	finishing	q.kit	q.pack	a	b	c	kg.x1	vol.x1
A132103-000	● noir/negro	x1	30	400	260	6,5	0,60	mc. 0.0031
A132104-000	● gris/gris	x1	30	400	260	6,5	0,60	mc. 0.0031
A132102-000	● rouge/rojo	x1	30	400	260	6,5	0,60	mc. 0.0031
A132116-000	● vert/verde	x1	30	400	260	6,5	0,60	mc. 0.0031
A132107-000	● bio-lolla/bio-lolla	x1	30	400	260	6,5	0,60	mc. 0.0031

03 jota chaise & tabouret - couverture de dossier en technopolymère
jota silla & taburete - cubierta del respaldo de tecnopolimero

code	finishing	q.kit	q.pack	a	b	c	kg.x1	vol.x1
A132103-001	● noir/negro	x1	60	285	120	3	0,09	mc. 0.00055
A132104-001	● gris/gris	x1	60	285	120	3	0,09	mc. 0.00055
A132102-001	● rouge/rojo	x1	60	285	120	3	0,09	mc. 0.00055
A132116-001	● vert/verde	x1	60	285	120	3	0,09	mc. 0.00055
A132107-001	● bio-lolla/bio-lolla	x1	60	285	120	3	0,09	mc. 0.00055

04 jota chaise & tabouret - petit panneau pour dossier en plastique à tapisser
jota silla & taburete - panel pequeño para respaldo en plástico tapizable

code	finishing	q.kit	q.pack	a	b	c	kg.x1	vol.x1
A132103-003	● noir/negro	x1	30	395	255	5	0,40	mc. 0.0031

05 jota chaise & tabouret - assise en technopolymère à tapisser
jota silla & taburete - asiento de tecnopolimero tapizable

code	finishing	q.kit	q.pack	a	b	c	kg.x1	vol.x1
A132203-000	● noir/negro	x1	20	400	380	8	0,95	mc. 0.0047
A132204-002	● gris/gris	x1	20	400	380	8	0,95	mc. 0.0047
A132202-000	● rouge/rojo	x1	20	400	380	8	0,95	mc. 0.0047
A132216-000	● vert/verde	x1	20	400	380	8	0,95	mc. 0.0047
A132207-000	● bio-lolla/bio-lolla	x1	20	400	380	8	0,95	mc. 0.0047

06 jota chaise & tabouret - couverture d'assise en technopolymère
jota silla & taburete - cubierta del asiento de tecnopolimero

code	finishing	q.kit	q.pack	a	b	c	kg.x1	vol.x1
A132203-001	● noir/negro	x1	40	185	215	3	0,10	mc. 0.0008
A132204-001	● gris/gris	x1	40	185	215	3	0,10	mc. 0.0008
A132202-001	● rouge/rojo	x1	40	185	215	3	0,10	mc. 0.0008
A132216-001	● vert/verde	x1	40	185	215	3	0,10	mc. 0.0008
A132207-001	● bio-lolla/bio-lolla	x1	40	185	215	3	0,10	mc. 0.0008

07 jota chaise & tabouret - PF2 entretoises à tête bombée en polyéthylène
jota silla & taburete - PF2 - separadores con cabeza redondeada de polietileno

code	finishing	q.kit
134403-101	● noir/negro	x4

08 jota chaise & tabouret - T114 - embout aileté à tête sphérique - ø14
jota silla & taburete - T114 - tapón aleteado con cabeza esférica - ø14

code	finishing	q.kit
134203-140	● noir/negro	x2

09 jota chaise - IRA - embout aileté en polyéthylène - ø12
jota silla - IRA - tapón aleteado de polietileno - ø12

code	finishing	q.kit
134203-030	● noir/negro	x2

main component sizes

jota

4-legs w/armrests

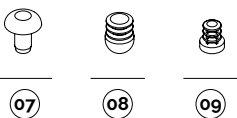
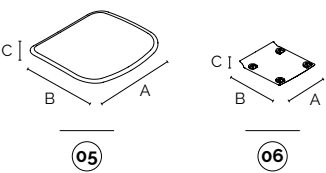
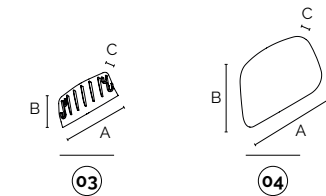
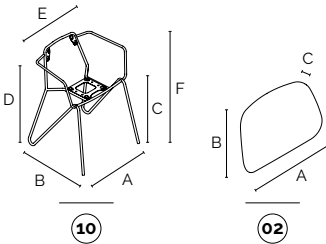
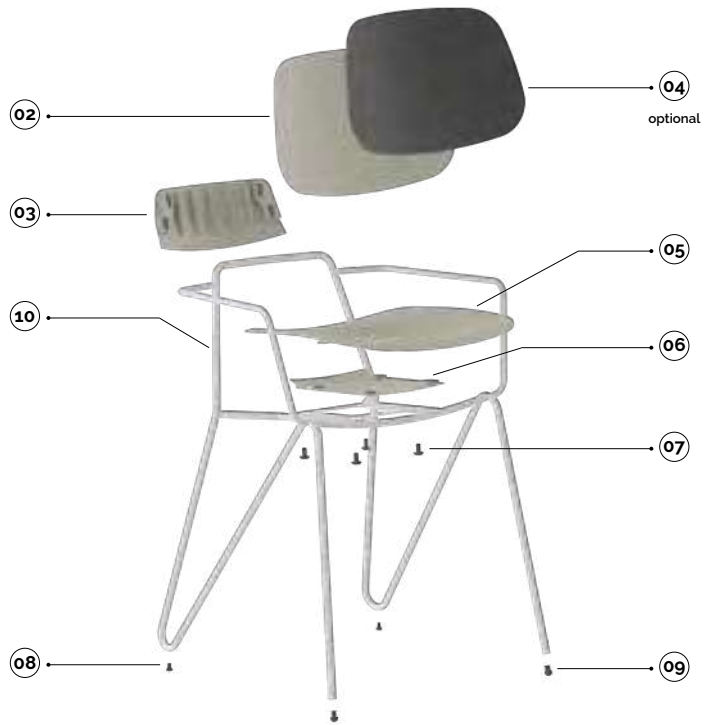

main component sizes

10 jota chaise - châssis à quatre pieds en métal avec accoudoirs
jota silla - estructura de 4 patas metálicas con reposabrazos

code	finishing	q.kit	q.pack	a	b	c	d	e	f	kg.x1	vol.x1
A110103-075	● noir/negro	x1	30/40	500	500	458	649	540	680	4.17	/
A110105-075	● blanc/blanco	x1	30/40	500	500	458	649	540	680	4.17	/
A110110-075	● chromé/cromado	x1	30/40	500	500	458	649	540	680	4.17	/

02 jota chaise & tabouret - dossier en technopolymère
jota silla & taburete - respaldo de tecnopolimero

code	finishing	q.kit	q.pack	a	b	c	kg.x1	vol.x1
A132103-000	● noir/negro	x1	30	400	260	6,5	0,60	mc. 0.0031
A132104-000	● gris/gris	x1	30	400	260	6,5	0,60	mc. 0.0031
A132102-000	● rouge/rojo	x1	30	400	260	6,5	0,60	mc. 0.0031
A132116-000	● vert/verde	x1	30	400	260	6,5	0,60	mc. 0.0031
A132107-000	● bio-lolla/bio-lolla	x1	30	400	260	6,5	0,60	mc. 0.0031

03 jota chaise & tabouret - couverture de dossier en technopolymère
jota silla & taburete - cubierta del respaldo de tecnopolimero

code	finishing	q.kit	q.pack	a	b	c	kg.x1	vol.x1
A132103-001	● noir/negro	x1	60	285	120	3	0,09	mc. 0.00055
A132104-001	● gris/gris	x1	60	285	120	3	0,09	mc. 0.00055
A132102-001	● rouge/rojo	x1	60	285	120	3	0,09	mc. 0.00055
A132116-001	● vert/verde	x1	60	285	120	3	0,09	mc. 0.00055
A132107-001	● bio-lolla/bio-lolla	x1	60	285	120	3	0,09	mc. 0.00055

04 jota chaise & tabouret - petit panneau pour dossier en plastique à tapisser
jota silla & taburete - panel pequeño para respaldo en plástico tapizable

code	finishing	q.kit	q.pack	a	b	c	kg.x1	vol.x1
A132103-003	● noir/negro	x1	30	395	255	5	0,40	mc. 0.0031

05 jota chaise & tabouret - assise en technopolymère à tapisser
jota silla & taburete - asiento de tecnopolimero tapizable

code	finishing	q.kit	q.pack	a	b	c	kg.x1	vol.x1
A132203-000	● noir/negro	x1	20	400	380	8	0,95	mc. 0.0047
A132204-002	● gris/gris	x1	20	400	380	8	0,95	mc. 0.0047
A132202-000	● rouge/rojo	x1	20	400	380	8	0,95	mc. 0.0047
A132216-000	● vert/verde	x1	20	400	380	8	0,95	mc. 0.0047
A132207-000	● bio-lolla/bio-lolla	x1	20	400	380	8	0,95	mc. 0.0047

06 jota chaise & tabouret - couverture d'assise en technopolymère
jota silla & taburete - cubierta del asiento de tecnopolimero

code	finishing	q.kit	q.pack	a	b	c	kg.x1	vol.x1
A132203-001	● noir/negro	x1	40	185	215	3	0,10	mc. 0.0008
A132204-001	● gris/gris	x1	40	185	215	3	0,10	mc. 0.0008
A132202-001	● rouge/rojo	x1	40	185	215	3	0,10	mc. 0.0008
A132216-001	● vert/verde	x1	40	185	215	3	0,10	mc. 0.0008
A132207-001	● bio-lolla/bio-lolla	x1	40	185	215	3	0,10	mc. 0.0008

07 jota chaise & tabouret - PF2 entretoises à tête bombée en polyéthylène
jota silla & taburete - PF2 - separadores con cabeza redondeada de polietileno

code	finishing	q.kit
134403-101	● noir/negro	x4

08 jota sedia & sgabello - T114 - puntale alettato a testa sferica - d.14
jota chair & stool - T114 - ribbed spherical head insert - d.14

code	finishing	q.kit
134203-140	● noir/negro	x2

09 jota chaise - IRA - embout aileté en polyéthylène - ø12
jota silla - IRA - tapón aleteado de polietileno - ø12

code	finishing	q.kit
134203-030	● noir/negro	x2

jota

stool h.650

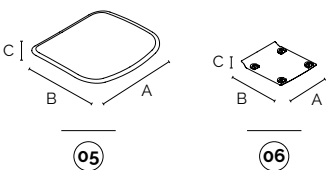
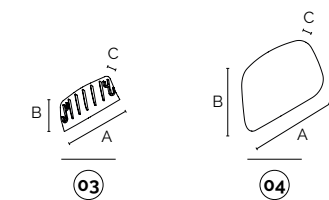
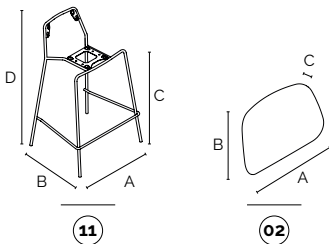
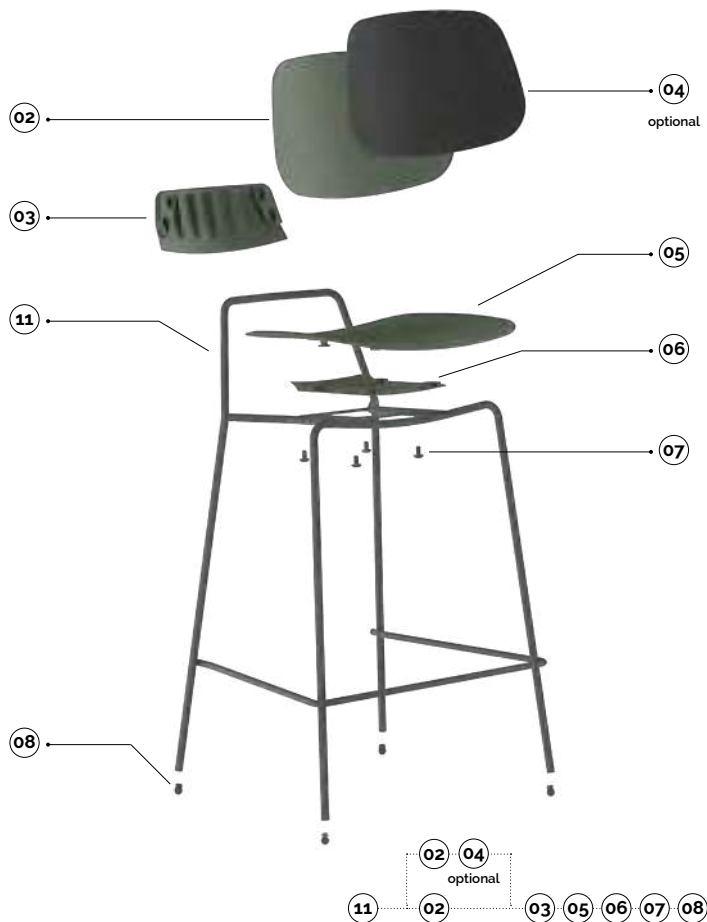

11 jota tabouret bas - tabouret à quatre pieds en métal - h.650
jota taburete bajo - estructura de 4 patas metálicas - h.650

code	finishing	q.kit	q.pack	a	b	c	d	kg.x1	vol.x1
A110603-034	● noir/negro	x1	20/30	530	470	640	830	3,95	/
A110605-034	● blanc/blanco	x1	20/30	530	470	640	830	3,95	/
A110610-034	● chromé/cromado	x1	20/30	530	470	640	830	3,95	/

02 jota chaise & tabouret - dossier en technopolymère
jota silla & taburete - respaldo de tecnopolimero

code	finishing	q.kit	q.pack	a	b	c	kg.x1	vol.x1
A132103-000	● noir/negro	x1	30	400	260	6,5	0,60	mc. 0.00031
A132104-000	● gris/gris	x1	30	400	260	6,5	0,60	mc. 0.00031
A132102-000	● rouge/rojo	x1	30	400	260	6,5	0,60	mc. 0.00031
A132116-000	● vert/verde	x1	30	400	260	6,5	0,60	mc. 0.00031
A132107-000	● bio-lolla/bio-lolla	x1	30	400	260	6,5	0,60	mc. 0.00031

03 jota chaise & tabouret - couverture de dossier en technopolymère
jota silla & taburete - cubierta del respaldo de tecnopolimero

code	finishing	q.kit	q.pack	a	b	c	kg.x1	vol.x1
A132103-001	● noir/negro	x1	60	285	120	3	0,09	mc. 0.00055
A132104-001	● gris/gris	x1	60	285	120	3	0,09	mc. 0.00055
A132102-001	● rouge/rojo	x1	60	285	120	3	0,09	mc. 0.00055
A132116-001	● vert/verde	x1	60	285	120	3	0,09	mc. 0.00055
A132107-001	● bio-lolla/bio-lolla	x1	60	285	120	3	0,09	mc. 0.00055

04 jota chaise & tabouret - petit panneau pour dossier en plastique à tapisser
jota silla & taburete - panel pequeño para respaldo en plástico tapizable

code	finishing	q.kit	q.pack	a	b	c	kg.x1	vol.x1
A132103-003	● noir/negro	x1	30	395	255	5	0,40	mc. 0.00031

05 jota chaise & tabouret - assise en technopolymère à tapisser
jota silla & taburete - asiento de tecnopolimero tapizable

code	finishing	q.kit	q.pack	a	b	c	kg.x1	vol.x1
A132203-000	● noir/negro	x1	20	400	380	8	0,95	mc. 0.00047
A132204-002	● gris/gris	x1	20	400	380	8	0,95	mc. 0.00047
A132202-000	● rouge/rojo	x1	20	400	380	8	0,95	mc. 0.00047
A132216-000	● vert/verde	x1	20	400	380	8	0,95	mc. 0.00047
A132207-000	● bio-lolla/bio-lolla	x1	20	400	380	8	0,95	mc. 0.00047

06 jota chaise & tabouret - couverture d'assise en technopolymère
jota silla & taburete - cubierta del asiento de tecnopolimero

code	finishing	q.kit	q.pack	a	b	c	kg.x1	vol.x1
A132203-001	● noir/negro	x1	40	185	215	3	0,10	mc. 0.00008
A132204-001	● gris/gris	x1	40	185	215	3	0,10	mc. 0.00008
A132202-001	● rouge/rojo	x1	40	185	215	3	0,10	mc. 0.00008
A132216-001	● vert/verde	x1	40	185	215	3	0,10	mc. 0.00008
A132207-001	● bio-lolla/bio-lolla	x1	40	185	215	3	0,10	mc. 0.00008

07 jota chaise & tabouret - PF2 entretoises à tête bombée en polyéthylène
jota silla & taburete - PF2 - separadores con cabeza redondeada de polietileno

code	finishing	q.kit
134403-101	● noir/negro	x4

08 jota chaise & tabouret - T14 - embout aileté à tête sphérique - ø14
jota silla & taburete - T14 - tapón aleteado con cabeza esférica - ø14

code	finishing	q.kit
134203-140	● noir/negro	x4

main component sizes

jota

stool h.750

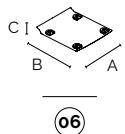
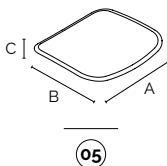
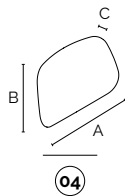
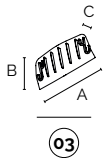
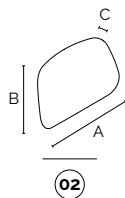
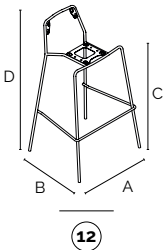
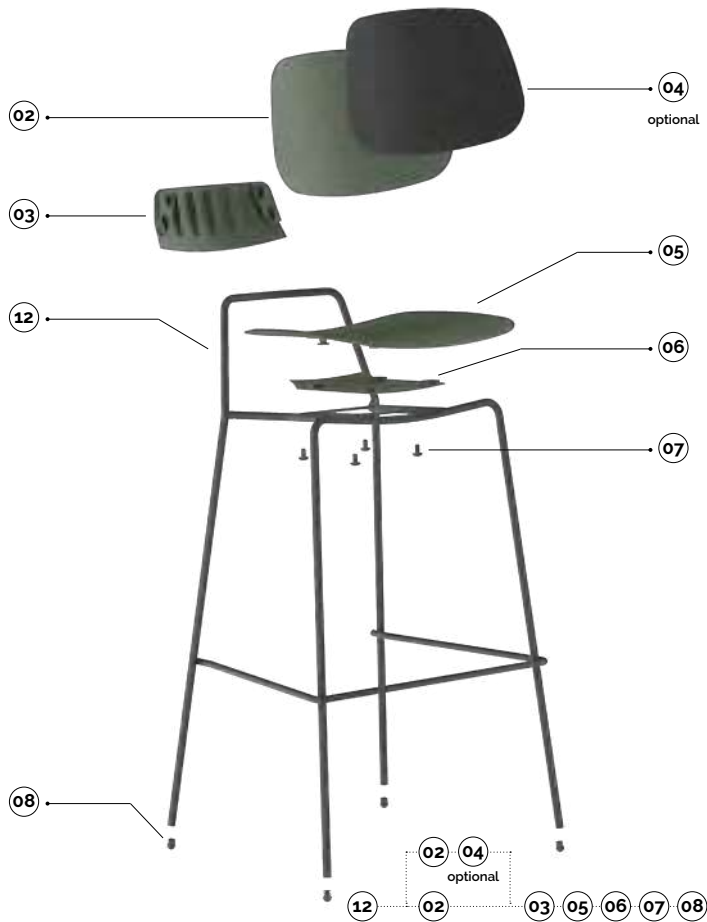

12 jota tabouret haut - tabouret à quatre pieds en métal - h.750
jota taburete alto - estructura de cuatro patas de metal - h.750

code	finishing	q.kit	q.pack	a	b	c	d	kg.x1	vol.x1
A110603-039	● noir/negro	x1	20/30	540	480	740	930	4.18	/
A110605-039	● blanc/blanco	x1	20/30	540	480	740	930	4.18	/
A110610-039	● chromé/cromado	x1	20/30	540	480	740	930	4.18	/

02 jota chaise & tabouret - dossier en technopolymère
jota silla & taburete - respaldo de tecnopolimero

code	finishing	q.kit	q.pack	a	b	c	kg.x1	vol.x1
A132103-000	● noir/negro	x1	30	400	260	6,5	0,60	mc. 0.0031
A132104-000	● gris/gris	x1	30	400	260	6,5	0,60	mc. 0.0031
A132102-000	● rouge/rojo	x1	30	400	260	6,5	0,60	mc. 0.0031
A132116-000	● vert/verde	x1	30	400	260	6,5	0,60	mc. 0.0031
A132107-000	● bio-lolla/bio-lolla	x1	30	400	260	6,5	0,60	mc. 0.0031

03 jota chaise & tabouret - couverture de dossier en technopolymère
jota silla & taburete - cubierta del respaldo de tecnopolimero

code	finishing	q.kit	q.pack	a	b	c	kg.x1	vol.x1
A132103-001	● noir/negro	x1	60	285	120	3	0,09	mc. 0.00055
A132104-001	● gris/gris	x1	60	285	120	3	0,09	mc. 0.00055
A132102-001	● rouge/rojo	x1	60	285	120	3	0,09	mc. 0.00055
A132116-001	● vert/verde	x1	60	285	120	3	0,09	mc. 0.00055
A132107-001	● bio-lolla/bio-lolla	x1	60	285	120	3	0,09	mc. 0.00055

04 jota chaise & tabouret - petit panneau pour dossier en plastique à tapisser
jota silla & taburete - panel pequeño para respaldo en plástico tapizable

code	finishing	q.kit	q.pack	a	b	c	kg.x1	vol.x1
A132103-003	● noir/negro	x1	30	395	255	5	0,40	mc. 0.0031

05 jota chaise & tabouret - assise en technopolymère à tapisser
jota silla & taburete - asiento de tecnopolimero tapizable

code	finishing	q.kit	q.pack	a	b	c	kg.x1	vol.x1
A132203-000	● noir/negro	x1	20	400	380	8	0,95	mc. 0.0047
A132204-002	● gris/gris	x1	20	400	380	8	0,95	mc. 0.0047
A132202-000	● rouge/rojo	x1	20	400	380	8	0,95	mc. 0.0047
A132216-000	● vert/verde	x1	20	400	380	8	0,95	mc. 0.0047
A132207-000	● bio-lolla/bio-lolla	x1	20	400	380	8	0,95	mc. 0.0047

06 jota chaise & tabouret - couverture d'assise en technopolymère
jota silla & taburete - cubierta del asiento de tecnopolimero

code	finishing	q.kit	q.pack	a	b	c	kg.x1	vol.x1
A132203-001	● noir/negro	x1	40	185	215	3	0,10	mc. 0.0008
A132204-001	● gris/gris	x1	40	185	215	3	0,10	mc. 0.0008
A132202-001	● rouge/rojo	x1	40	185	215	3	0,10	mc. 0.0008
A132216-001	● vert/verde	x1	40	185	215	3	0,10	mc. 0.0008
A132207-001	● bio-lolla/bio-lolla	x1	40	185	215	3	0,10	mc. 0.0008

07 jota chaise & tabouret - PF2 entretoises à tête bombée en polyéthylène
jota silla & taburete - PF2 - separadores con cabeza redondeada de polietileno

code	finishing	q.kit
134403-101	● noir/negro	x4

08 jota chaise & tabouret - T14 - embout aileté à tête sphérique - ø14
jota silla & taburete - T14 - tapón aleteado con cabeza esférica - ø14

code	finishing	q.kit
134203-140	● noir/negro	x4

main component sizes



maui



discover more about
Maui Collection

Maui est une collection complète et polyvalente de sièges à tapisser, adaptée aux espaces contractuels, aux environnements résidentiels et aux environnements réceptifs. Les fauteuils Maui sont disponibles en trois types de coques en polyuréthane: Dining, Lounge et Lounge Plus, qui peuvent être combinées avec des bases pivotantes en aluminium ou des châssis sur patins en métal. La collection est complétée par une table basse polyvalente avec une base en métal.

Les coques sont fournies en brut, à tapisser.

Maui es una colección completa y versátil de asientos tapizados, adecuada para espacios contractuales, entornos residenciales y de hostelería. Los sillones Maui están disponibles en tres tipos diferentes de carcasas de poliuretano: Dining, Lounge y Lounge Plus, todas las cuales se pueden combinar con bases giratorias de aluminio o estructuras de patín metálicas. La colección se completa con una mesa de centro versátil con base metálica.

Las carcasas se suministran en bruto, para tapizar.

Plus

- Idéal pour les environnements contractuels, résidentiels, d'hôtellerie et domestiques.
- 3 variantes: Dining, Lounge et Lounge Plus.
- Table basse polyvalente assortie aux sièges.
- *Ideal para entornos contractuales, residenciales, hosteleros y domésticos.*
- *3 variantes: Dining, Lounge y Lounge Plus.*
- *Mesa de centro versátil a juego con los asientos.*



designed by:
StudioPANG

maui

dining sled

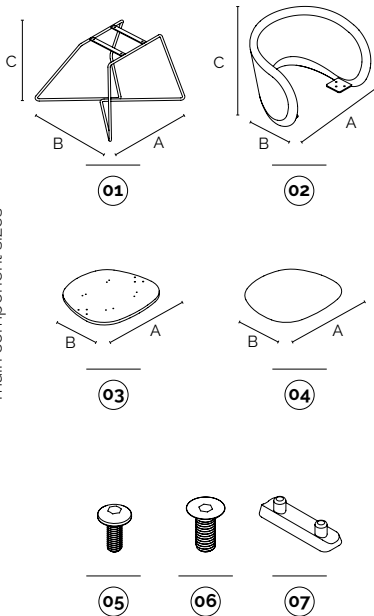
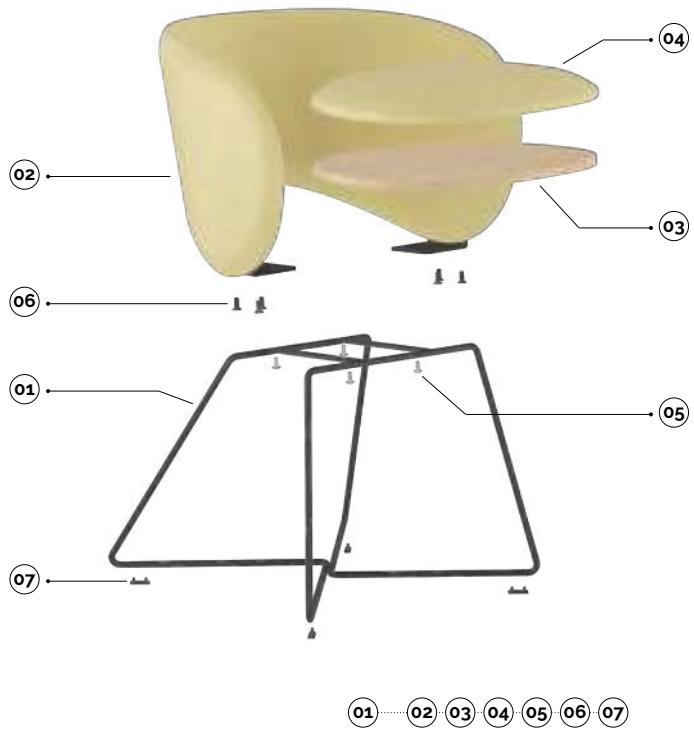

main component sizes

01 maui dining - châssis à patins ø12
maui dining - estructura de patin ø12

code	finishing	q.kit	q.pack	a	b	c	kg.x1	vol.x1
A113403-115	● noir/negro	x1	/	560	540	410	3.95	/
A113405-115	● blanc/blanco	x1	/	560	540	410	3.95	/
113410-115	● chromé/cromado	x1	/	560	540	410	3.95	/

02 maui dining - coque de dossier
maui dining - carcasa de respaldo

code	finishing	q.kit	q.pack	a	b	c	kg.x1	vol.x1
A133908-008	∅ à tapisser/para empapelar	x1	/	590	490	400	8.00	/

03 maui dining - panneau en contreplaqué pour assise
maui dining - panel de madera de pino contrachapada para asiento

code	finishing	q.kit	q.pack	a	b	kg.x1	vol.x1
A123607-069	● pin/pino	x1	/	470	450	1.60	/

04 maui dining - coussin pour assise
maui dining - almohada para asiento

code	finishing	q.kit	q.pack	a	b	kg.x1	vol.x1
A134001-006	∅ à tapisser/para empapelar	x1	/	470	450	0.332	/

05 châssis à patins - vis crantée TBEI M6x16
estructuras de patin - tornillo dentado TBEI M6x16

code	finishing	q.kit	q.pack
117711-185	● blanc zingué/blanco galvanizado	x4	/

06 maui dining & lounge & lounge plus - vis avec frein-filet TSPEI M8x20
maui dining & lounge & lounge plus - tornillo anti-desenroscado TSPEI M8x20

code	finishing	q.kit	q.pack
117703-257	● noir bruni/negro bruñido	x6	/

07 châssis à patins - patin en plastique à deux broches
estructuras de patin - pie de plástico con dos ganchos

code	finishing	q.kit	q.pack
A134303-000	● noir/negro	x4	/

maui

dining swivel

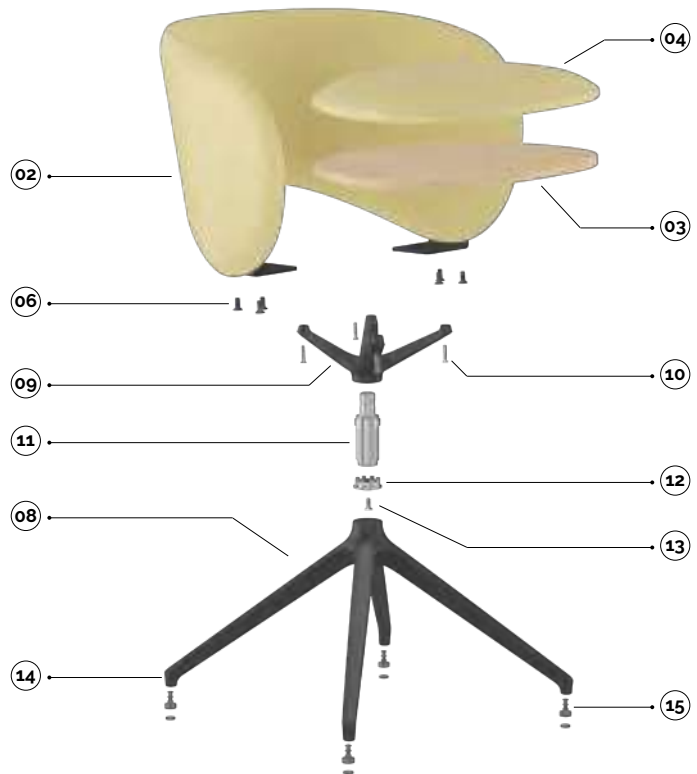

08 02 03 04 06 09 10 11 12 13 14 15

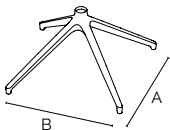

08

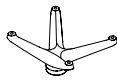

09



10



11



12



13



14



15

main component sizes

08 maui dining - base Kylie en aluminium à 4 branches - ø720
maui dining - base de aluminio de 4 radios de aluminio de 4 radios - ø720

code	finishing	q.kit	q.pack	a	b	kg.x1	vol.x1
A110203-100	● noir/negro	x1	6	515	515	2,79	/
A110210-000	● brillant/brillante	x1	6	515	515	2,79	/

09 maui dining - support en aluminium pour base Kylie - ø720
maui dining - soporte de aluminio para base Kylie - ø720

code	finishing	q.kit	q.pack	kg.x1	vol.x1
A110203-103	● noir/negro	x1	6	0,71	/
A110210-003	● brillant/brillante	x1	6	0,71	/

10 bases en aluminium à 4 branches Kylie - vis TSP+ M6x30
bases de aluminio de 4 radios Kylie - tornillo TSP+ M6x30

code	finishing	q.kit	q.pack
117711-192	● blanc zingué/blanco galvanizado	x4	/

11 bases en aluminium à 4 branches Kylie - adaptateur en métal
bases de aluminio de 4 radios Kylie - adaptador metálico

code	finishing	q.kit	q.pack	kg.x1
A110210-001	● zingué/galvanizado	x1	6	/

12 bases en aluminium à 4 branches Kylie - bouchon sous la base
bases de aluminio de 4 radios Kylie - tapón de subbase

code	finishing	q.kit	q.pack	kg.x1
A110210-002	● gris/gris	x1	6	/

13 bases en aluminium à 4 branches Kylie - vis TSP+ M6x20
bases de aluminio de 4 radios Kylie - tornillo TSP+ M6x20

code	finishing	q.kit	q.pack
117711-203	● blanc zingué/blanco galvanizado	x1	6

14 bases en aluminium à 4 branches Kylie - pied en polypropylène
bases de aluminio de 4 radios Kylie - pie de polipropileno

code	finishing	q.kit	q.pack	kg.x1
A110210-004	● gris/gris	x4	24	/

15 bases en aluminium à 4 branches Kylie - feutre pour pied en polypropylène
bases de aluminio de 4 radios Kylie - fieltro para pie de polipropileno

code	finishing	q.kit	q.pack
A110210-005	● noir/negro	x4	24

for the components below, see previous page

02 03 04 06

maui

lounge sled

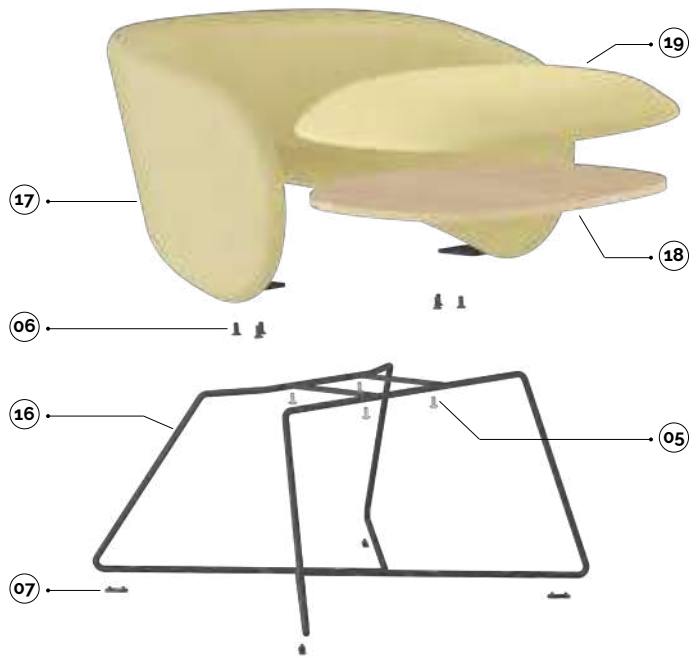

16 17 18 19 05 06 07

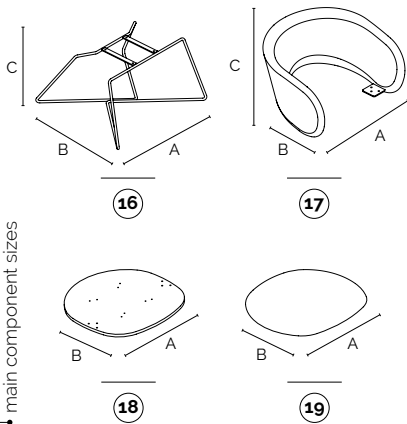

main component sizes

16 maui lounge & lounge plus - châssis à patins - ø12 maui lounge & lounge plus - estructura de patin - ø12

code	finishing	q.kit	q.pack	a	b	c	kg.x1	vol.x1
A113403-110	● noir/negro	x1	/	650	610	360	4.30	/
A113405-110	● blanc/blanco	x1	/	650	610	360	4.30	/
113410-110	● chromé/cromado	x1	/	650	610	360	4.30	/

17 maui lounge - coque de dossier maui lounge - carcasa de respaldo

code	finishing	q.kit	q.pack	a	b	c	kg.x1	vol.x1
A133908-010	∅ à tapisser/para empapelar	x1	/	720	670	410	10.80	/

18 maui lounge & lounge plus - panneau en contreplaqué pour assise maui lounge & lounge plus - panel de madera de pino contrachapada para asiento

code	finishing	q.kit	q.pack	a	b	kg.x1	vol.x1
A123607-070	● pin/pino	x1	/	580	580	2.78	/

19 maui lounge & lounge plus - coussin pour assise maui lounge & lounge plus - almohada para asiento

code	finishing	q.kit	q.pack	a	b	kg.x1	vol.x1
A134001-005	∅ à tapisser/para empapelar	x1	/	580	580	0.57	/

05 châssis à patins - vis crantée TBEI M6x16 estructuras de patin - tornillo dentado TBEI M6x16

code	finishing	q.kit	q.pack
117711-185	● blanc zingué/blanco galvanizado	x4	/

06 maui dining & lounge & lounge plus - vis avec frein-filet TSPEI M8x20 maui dining & lounge & lounge plus - tornillo anti-desenroscado TSPEI M8x20

code	finishing	q.kit	q.pack
117703-257	● noir bruni/negro bruñido	x6	/

07 châssis à patins - patin en plastique à deux broches estructuras de patin - pie de plástico con dos ganchos

code	finishing	q.kit	q.pack
A134303-000	● noir/negro	x4	/

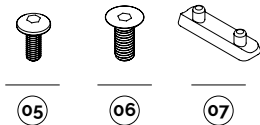

maui

lounge swivel

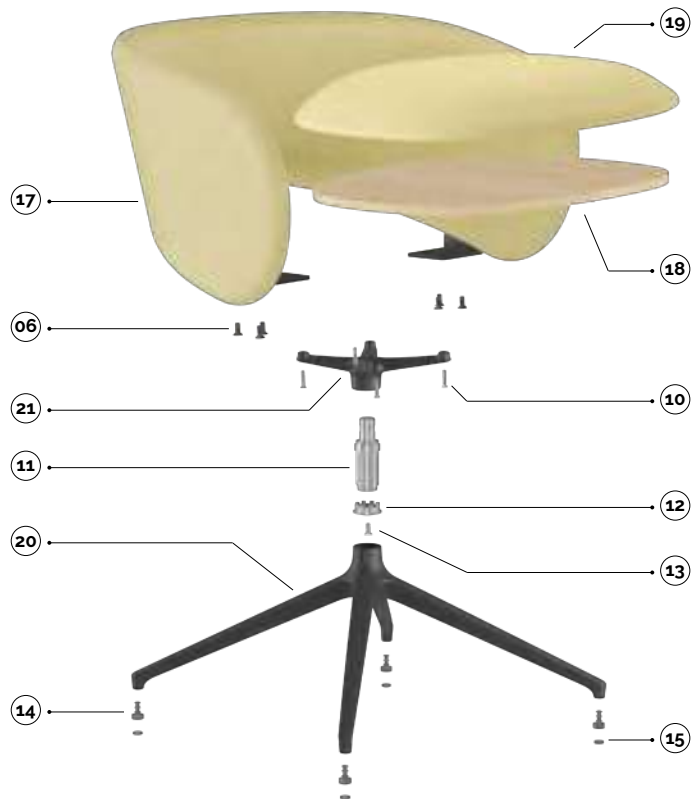

20 17 18 19 06 21 10 11 12 13 14 15

20 maui lounge & lounge plus - base Kylie en aluminium à 4 branches - ø840
maui lounge & lounge plus - base Kylie de aluminio de 4 radios - ø840

code	finishing	q.kit	q.pack	a	b	kg.x1	vol.x1
A110203-101	● noir/negro	x1	6	600	600	3.33	/
A110210-016	○ brillant/brillante	x1	6	600	600	3.33	/

21 maui lounge & lounge plus - support en aluminium pour base Kylie - ø840
maui lounge & lounge plus - soporte de aluminio para base Kylie - ø840

code	finishing	q.kit	q.pack	kg.x1	vol.x1
A110203-104	● noir/negro	x1	6	0.65	/
A110210-008	○ brillant/brillante	x1	6	0.65	/

10 bases en aluminium à 4 branches Kylie - vis TSP+ M6x30
bases de aluminio de 4 radios Kylie - tornillo TSP+ M6x30

code	finishing	q.kit	q.pack
117711-192	● blanc zingué/blanco galvanizado	x4	/

11 bases en aluminium à 4 branches Kylie - adaptateur en métal
bases de aluminio de 4 radios Kylie - adaptador metálico

code	finishing	q.kit	q.pack	kg.x1
A110210-001	● zingué/galvanizado	x1	6	/

12 bases en aluminium à 4 branches Kylie - bouchon sous la base
bases de aluminio de 4 radios Kylie - tapón de subbase

code	finishing	q.kit	q.pack	kg.x1
A110210-002	● gris/gris	x1	6	/

13 bases en aluminium à 4 branches Kylie - vis TSP+ M6x20
bases de aluminio de 4 radios Kylie - tornillo TSP+ M6x20

code	finishing	q.kit	q.pack
117711-203	● blanc zingué/blanco galvanizado	x1	6

14 bases en aluminium à 4 branches Kylie - pied en polypropylène
bases de aluminio de 4 radios Kylie - pie de polipropileno

code	finishing	q.kit	q.pack	kg.x1
A110210-004	● gris/gris	x4	24	/

15 bases en aluminium à 4 branches Kylie - feutre pour pied en polypropylène
bases de aluminio de 4 radios Kylie - fieltro para pie de polipropileno

code	finishing	q.kit	q.pack
A110210-005	● noir/negro	x4	24

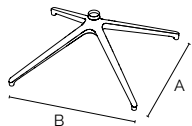

20

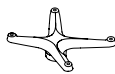

21



10



11



12



13



14



15

main component sizes

for the components below, see previous page

17 18 19 06

maui

lounge plus sled

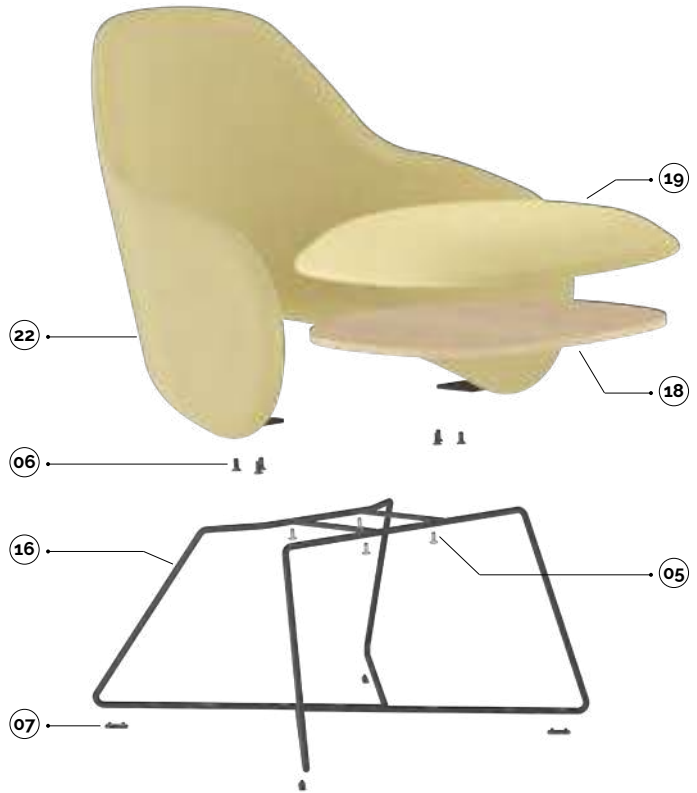

16 22 18 19 05 06 07

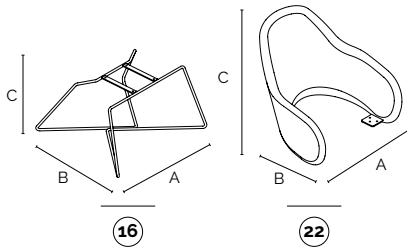

main component sizes

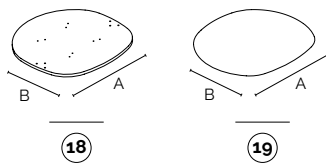

18

19

05

06

07

16 maui lounge & lounge plus - châssis à patins - ø12 maui lounge & lounge plus - estructura de patin - ø12

code	finishing	q.kit	q.pack	a	b	c	kg.x1	vol.x1
A113403-110	● noir/negro	x1	/	650	610	360	4.30	/
A113405-110	● blanc/blanco	x1	/	650	610	360	4.30	/
113410-110	● chromé/cromado	x1	/	650	610	360	4.30	/

22 maui lounge plus - coque de dossier maui lounge plus - carcasa de respaldo

code	finishing	q.kit	q.pack	a	b	c	kg.x1	vol.x1
A133908-009	∅ à tapisser/para empapelar	x1	/	720	755	670	11.30	/

18 maui lounge & lounge plus - panneau en contreplaqué pour assise maui lounge & lounge plus - panel de madera de pino contrachapada para asiento

code	finishing	q.kit	q.pack	a	b	kg.x1	vol.x1
A123607-070	● pin/pino	x1	/	580	580	2.78	/

19 maui lounge & lounge plus - coussin pour assise maui lounge & lounge plus - almohada para asiento

code	finishing	q.kit	q.pack	a	b	kg.x1	vol.x1
A134001-005	∅ à tapisser/para empapelar	x1	/	580	580	0.57	/

05 châssis à patins - vis crantée TBEI M6x16 estructuras de patin - tornillo dentado TBEI M6x16

code	finishing	q.kit	q.pack
117711-185	● blanc zingué/blanco galvanizado	x4	/

06 maui dining & lounge & lounge plus - vis avec frein-filet TSPEI M8x20 maui dining & lounge & lounge plus - tornillo anti-desenroscado TSPEI M8x20

code	finishing	q.kit	q.pack
117703-257	● noir bruni/negro bruñido	x6	/

07 châssis à patins - patin en plastique à deux broches estructuras de patin - pie de plástico con dos ganchos

code	finishing	q.kit	q.pack
A134303-000	● noir/negro	x4	/

maui

lounge plus swivel

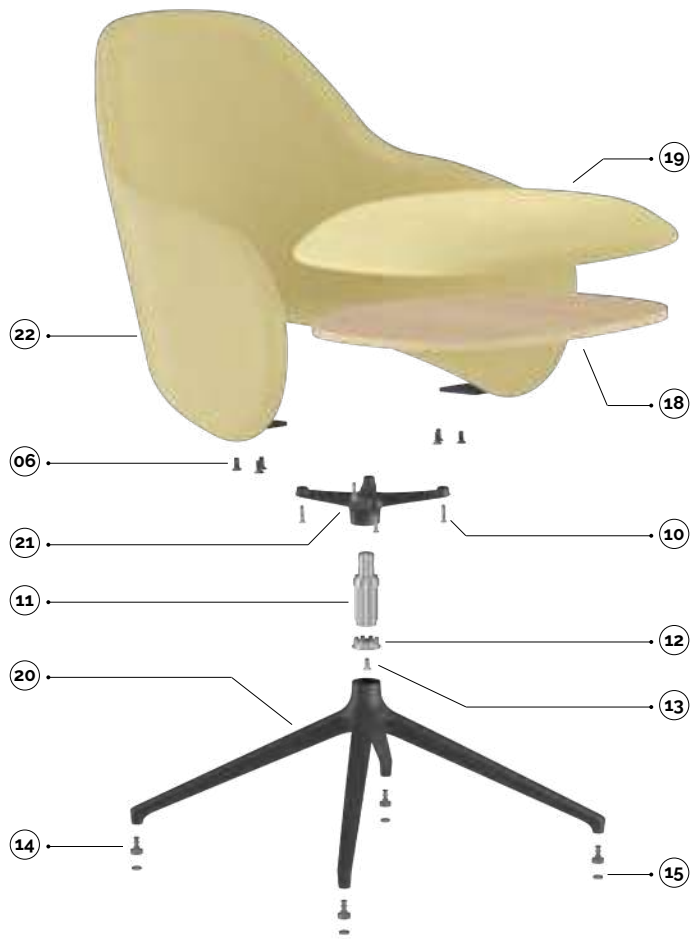

20 22 18 19 06 21 10 11 12 13 14 15

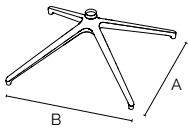

20

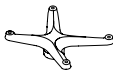

21



10



11



12



13



14



15

main component sizes

20 maui lounge & lounge plus - base Kylie en aluminium à 4 branches - ø840
maui lounge & lounge plus - base Kylie de aluminio de 4 radios - ø840

code	finishing	q.kit	q.pack	a	b	kg.x1	vol.x1
A110203-101	● noir/negro	x1	6	600	600	3.33	/
A110210-016	○ brillant/brillante	x1	6	600	600	3.33	/

21 maui lounge & lounge plus - support en aluminium pour base Kylie - ø840
maui lounge & lounge plus - soporte de aluminio para base Kylie - ø840

code	finishing	q.kit	q.pack	kg.x1	vol.x1
A110203-104	● noir/negro	x1	6	0.65	/
A110210-008	○ brillant/brillante	x1	6	0.65	/

10 bases en aluminium à 4 branches Kylie - vis TSP+ M6x30
bases de aluminio de 4 radios Kylie - tornillo TSP+ M6x30

code	finishing	q.kit	q.pack
117711-192	● blanc zingué/blanco galvanizado	x4	/

11 bases en aluminium à 4 branches Kylie - adaptateur en métal
bases de aluminio de 4 radios Kylie - adaptador metálico

code	finishing	q.kit	q.pack	kg.x1
A110210-001	● zingué/galvanizado	x1	6	/

12 bases en aluminium à 4 branches Kylie - bouchon sous la base
bases de aluminio de 4 radios Kylie - tapón de subbase

code	finishing	q.kit	q.pack	kg.x1
A110210-002	● gris/gris	x1	6	/

13 bases en aluminium à 4 branches Kylie - vis TSP+ M6x20
bases de aluminio de 4 radios Kylie - tornillo TSP+ M6x20

code	finishing	q.kit	q.pack
117711-203	● blanc zingué/blanco galvanizado	x1	6

14 bases en aluminium à 4 branches Kylie - pied en polypropylène
bases de aluminio de 4 radios Kylie - pie de polipropileno

code	finishing	q.kit	q.pack	kg.x1
A110210-004	● gris/gris	x4	24	/

15 bases en aluminium à 4 branches Kylie - feutre pour pied en polypropylène
bases de aluminio de 4 radios Kylie - fieltro para pie de polipropileno

code	finishing	q.kit	q.pack
A110210-005	● noir/negro	x4	24

for the components below, see previous page

22 18 19 06

maui

metal rod
coffee table

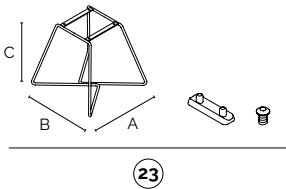
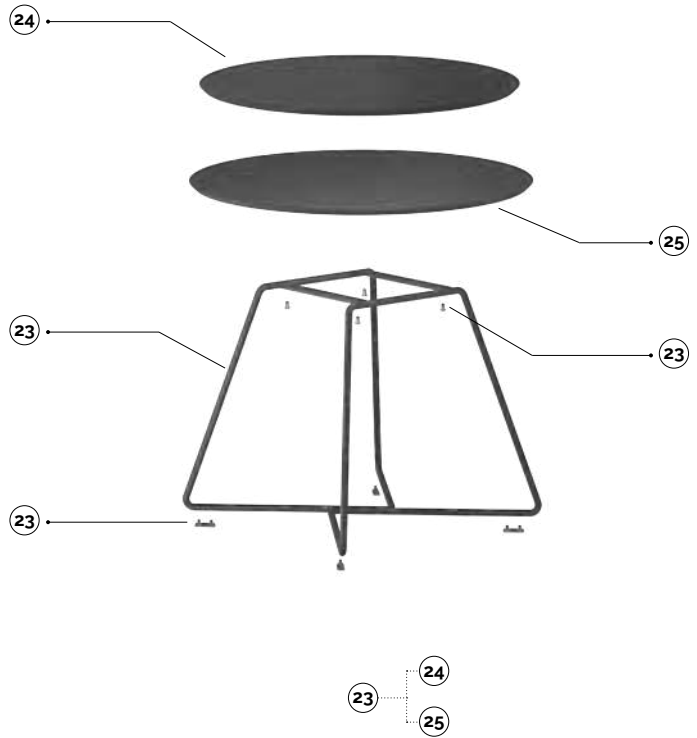

23

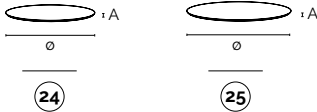

24

25

23 maui table basse - base en tige + pieds + vis pour le plateau
maui mesa baja - base de barra redonda + pies + tornillos por mesas

code	finishing	q.kit	q.pack	a	b	c	kg.x1	vol.x1
110303-706	● noir/negro	x1	30	447	455	408	3.55	mc. 0.1232
110304-705	● gris/gris	x1	30	447	455	408	3.55	mc. 0.1232
110305-705	● ivoire/marfil	x1	30	447	455	408	3.55	mc. 0.1232
110310-706	● chromé/cromado	x1	30	447	455	408	3.55	mc. 0.1232

24 maui - plateau en HPL rond ø590
maui - tapa de HPL redonda ø590

code	finishing	q.kit	q.pack	ø	a	kg.x1	vol.x1
120303-021	● noir/negro outdoor/indoor	x1	1	590	10	4.00	mc. 0.0072
120305-021	● ivoire/marfil outdoor/indoor	x1	1	590	10	4.00	mc. 0.0072

25 maui - plateau en HPL rond ø690
maui - tapa de HPL redonda ø690

code	finishing	q.kit	q.pack	ø	a	kg.x1	vol.x1
120303-022	● noir/negro outdoor/indoor	x1	1	690	10	5.70	mc. 0.0098
120305-022	● ivoire/marfil outdoor/indoor	x1	1	690	10	5.70	mc. 0.0098

main component sizes





meti



discover more about
Meti Collection

Meti est une collection de sièges avec et sans accoudoirs, avec un châssis en métal et une coque en polyuréthane à revêtir en tissu. Son dossier est enveloppant, confortable et accueillant, lui conférant une ligne élégante et épurée.

Les coques sont fournies en brut, à tapisser.

Meti es una colección de asientos con y sin reposabrazos, con estructura metálica y carcasa de poliuretano para revestir en tela. Su respaldo es envolvente, cómodo y acogedor, que le confiere una línea elegante y limpia.

Las carcasas se suministran en bruto, para tapizar.

Plus

- Idéal pour les environnements contractuels, résidentiels, d'hôtellerie et domestiques.
- *Ideal para entornos contractuales, residenciales, hosteleros y domésticos.*
- 2 variantes: chaise et fauteuil.
- *2 variantes: silla y sillón.*



designed by:
R&D Alba

meti

chair

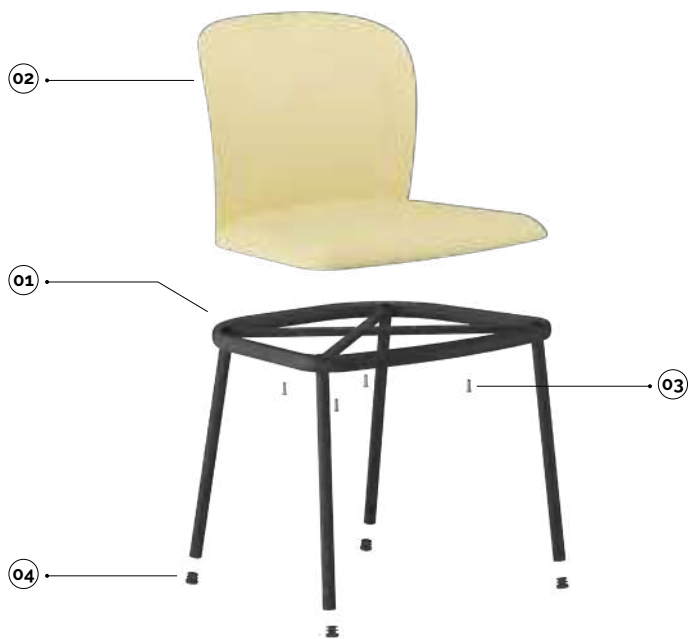

01 02 03 04

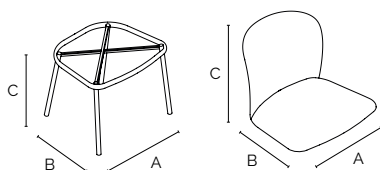

01

02



03



04

main component sizes

01 meti chaise - châssis à 4 pieds
meti silla - estructura de 4 patas

code	finishing	q.kit	q.pack	a	b	c	kg.x1	vol.x1
A110103-061	● noir/negro	x1	1	550	490	430	3,80	/
A110105-061	● blanc/blanco	x1	1	550	490	430	3,80	/
A110110-061	● chromé/cromado	x1	1	550	490	430	3,80	/

02 meti chaise - coque en polyuréthane
meti silla - carcasa de poliuretano

code	finishing	q.kit	q.pack	a	b	c	kg.x1	vol.x1
A133904-019	Ø à tapisser/para empapelar	x1	1	540	540	375	4,29	/

03 vis TBEI M6x25
tornillo TBEI M6x25

code	finishing	q.kit
117711-194	● zingué/galvanizado	x4

04 Tl22 embout ronde à ailettes - Ø.22
punta de aleta redonda Tl22 - Ø.22

code	finishing	q.kit
134203-220	● noir/negro	x4

meti

armchair

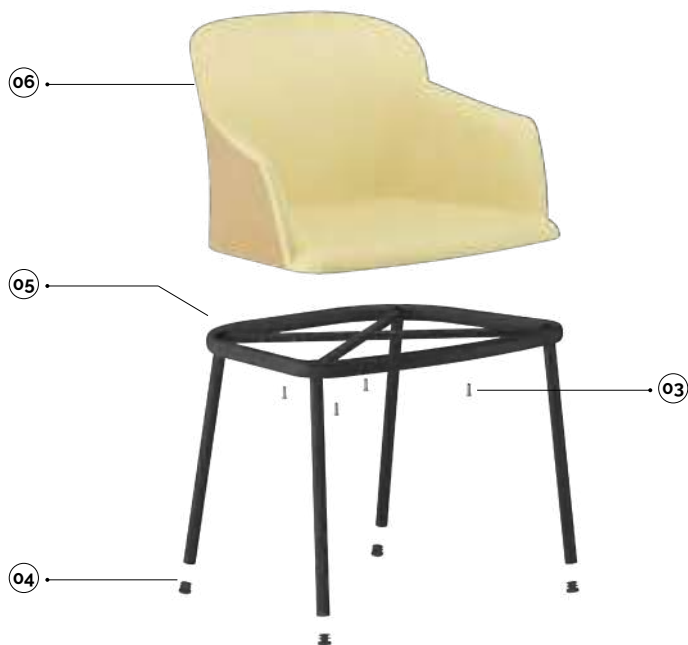

05 06 03 04

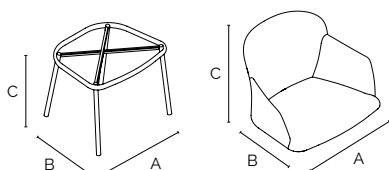

01

02



03



04

main component sizes

05 meti fauteuil - châssis à 4 pieds
meti sillón pequeño - estructura de 4 patas

code	finishing	q.kit	q.pack	a	b	c	kg.x1	vol.x1
A111603-095	● noir/negro	x1	1	590	490	430	3,95	/
A111605-095	● blanc/blanco	x1	1	590	490	430	3,95	/
A111610-095	● chromé/cromado	x1	1	590	490	430	3,95	/

06 meti fauteuil - coque en polyuréthane
meti sillón pequeño - carcasa de poliuretano

code	finishing	q.kit	q.pack	a	b	c	kg.x1	vol.x1
A133904-018	Ø à tapisser/para empapelar	x1	1	620	540	375	7,00	/

03 vis TBEI M6x25
tornillo TBEI M6x25

code	finishing	q.kit
117711-194	● zingué/galvanizado	x4

04 Tl22 embout ronde à ailettes - Ø.22
punta de aleta redonda Tl22 - Ø.22

code	finishing	q.kit
134203-220	● noir/negro	x4



tipper



discover more about
Tipper Collection

Idéale pour les environnements de conférence et de coworking, la collection Tipper offre des avantages fonctionnels et distinctifs: elle se distingue par une empilabilité horizontale totale, grâce aux pieds à fermeture inclinée, ainsi qu'une grande praticité, grâce aux poignées de verrouillage et déverrouillage situées des deux côtés, permettant d'incliner le plateau même d'une seule main.

Ideal para entornos de conferencias y coworking, la colección Tipper ofrece ventajas funcionales y distintivas: cuenta tanto con una apilabilidad horizontal total, gracias a sus patas inclinadas, como con la máxima practicidad, gracias a las asas bloqueables situadas a ambos lados, que permiten inclinar la parte superior con una sola mano.

Plus

- Mécanisme de basculement du plateau breveté.
- Certification ANSI/BIFMA X5.1.
- 3 modèles de pieds différents: Duo, Classic et Pro.
- Compatible avec tous les plateaux standard.
- 6 longueurs de traverse.
- *Mecanismo de inclinación de la mesa patentado.*
- *Certificación ANSI/BIFMA X5.1.*
- *3 modelos diferentes de patas: Duo, Classic y Pro.*
- *Compatible con todas las tapas estándar.*
- *6 longitudes de travesaño.*



designed by:
Esedra & R&D Alba



**certified
product**



**patented
product**

tipper

components

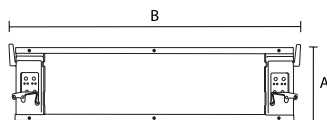
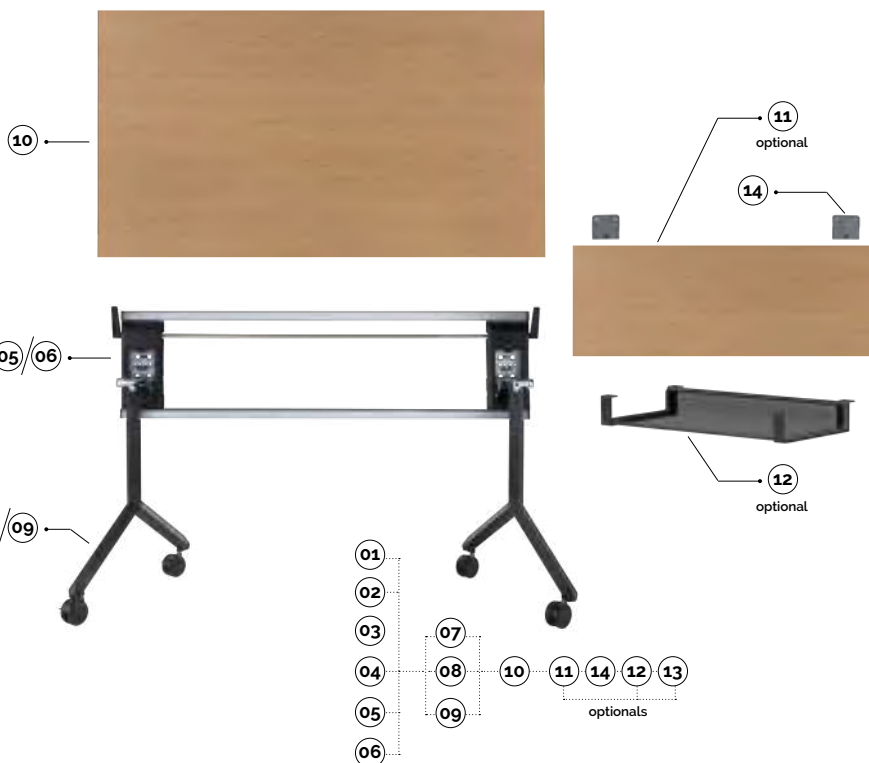

01 02 03 04 05 06

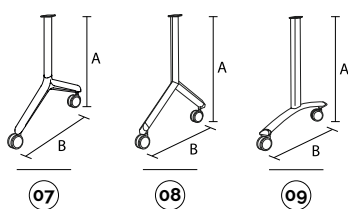

main component sizes

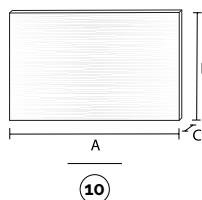

01 mécanisme 1000 rabattable pour plateau L1000 mecanismo 1000 abatible para mesa L1000									
code	finishing	q.kit	q.pack	a	b	kg.x1	vol.x1		
110311-660	● galvanisé/galvanizado	x1	1	360	965	7,18	mc. 0.0543		
02 mécanisme 1200 rabattable pour plateau L1200 mecanismo 1200 abatible para mesa L1200									
code	finishing	q.kit	q.pack	a	b	kg.x1	vol.x1		
110311-007	● galvanisé/galvanizado	x1	1	360	1165	8,09	mc. 0.0543		
03 mécanisme 1400 rabattable pour plateau L1400 mecanismo 1400 abatible para mesa L1400									
code	finishing	q.kit	q.pack	a	b	kg.x1	vol.x1		
110311-661	● galvanisé/galvanizado	x1	1	360	1365	8,98	mc. 0.0627		
04 mécanisme 1500 rabattable pour plateau L1500 mecanismo 1500 abatible para mesa L1500									
code	finishing	q.kit	q.pack	a	b	kg.x1	vol.x1		
110311-008	● galvanisé/galvanizado	x1	1	360	1465	9,30	mc. 0.0627		
05 mécanisme 1600 rabattable pour plateau L1600 mecanismo 1600 abatible para mesa L1600									
code	finishing	q.kit	q.pack	a	b	kg.x1	vol.x1		
110311-662	● galvanisé/galvanizado	x1	1	360	1565	9,64	mc. 0.0627		
06 mécanisme 1800 rabattable pour plateau L1800 mecanismo 1800 abatible para mesa L1800									
code	finishing	q.kit	q.pack	a	b	kg.x1	vol.x1		
110311-009	● galvanisé/galvanizado	x1	1	360	1765	10,57	mc. 0.0752		
07 duo-pied pour table avec accessoires duo-pata para mesa con accesorios									
code	finishing - metal frame	finishing - plastic foot	leg width	q.kit	q.pack	a	b	kg.x1	vol.x1
110303-270	● noir/negro ral 9005	● noir/negro ral 9005	600	x2	2	725	600	2,16	mc. 0.0126
110305-270	○ blanc/blanco ral 9010	○ blanc/blanco ral 9010	600	x2	2	725	600	2,16	mc. 0.0126
110304-270	● gris/gris drylac	● gris/gris drylac	600	x2	2	725	600	2,16	mc. 0.0126
110310-270	● chromé/cromado	● noir/negro ral 9005	600	x2	2	725	600	2,16	mc. 0.0126
110303-273	● noir/negro ral 9005	● noir/negro ral 9005	750	x2	2	725	750	2,32	mc. 0.0146
110305-273	○ blanc/blanco ral 9010	○ blanc/blanco ral 9010	750	x2	2	725	750	2,32	mc. 0.0146
110304-273	● gris/gris drylac	● gris/gris drylac	750	x2	2	725	750	2,32	mc. 0.0146
110310-273	● chromé/cromado	● noir/negro ral 9005	750	x2	2	725	750	2,32	mc. 0.0146
08 pro-pied pour table avec accessoires pro-pata para mesa con accesorios									
code	finishing	leg width	q.kit	q.pack	a	b	kg.x1	vol.x1	
110303-197	● nero rag./black	600	x2	2	725	600	3,55	mc. 0.0328	
110305-197	○ blanc/blanco	600	x2	2	725	600	3,55	mc. 0.0328	
110304-197	● gris/gris	600	x2	2	725	600	3,55	mc. 0.0328	
110303-199	● nero rag./black	750	x2	2	725	750	3,75	mc. 0.0328	
110305-199	○ blanc/blanco	750	x2	2	725	750	3,75	mc. 0.0328	
110304-199	● gris/gris	750	x2	2	725	750	3,75	mc. 0.0328	
09 classic-pied pour table avec accessoires classic-pata para mesa con accesorios									
code	finishing	leg width	q.kit	q.pack	a	b	kg.x1	vol.x1	
110303-196	● noir/negro	600	x2	2	725	600	3,7	mc. 0.0328	
110305-196	○ blanc/blanco	600	x2	2	725	600	3,7	mc. 0.0328	
110304-196	● gris/gris	600	x2	2	725	600	3,7	mc. 0.0328	
110310-196	● chromé/cromado	600	x2	2	725	600	3,7	mc. 0.0328	
110303-198	● noir/negro	750	x2	2	725	750	3,9	mc. 0.0328	
110305-198	○ blanc/blanco	750	x2	2	725	750	3,9	mc. 0.0328	
110304-198	● gris/gris	750	x2	2	725	750	3,9	mc. 0.0328	
110310-198	● chromé/cromado	750	x2	2	725	750	3,9	mc. 0.0328	
10 plateau en chêne tapa plana de madera de roble									
code	finishing	q.kit	q.pack	a	b	c	kg.x1	vol.x1	
120307-007	● chêne/roble	x1	1	1200	800	18	12,50	mc. 0.0173	
120307-008	● chêne/roble	x1	1	1500	900	18	17,50	mc. 0.0243	
120307-009	● chêne/roble	x1	1	1800	900	18	21,00	mc. 0.0291	

tipper

components and optionals

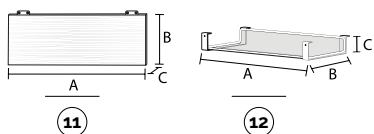

11

12

11 panneau de modestie avec accessoires
tablero de cortesia con accesorios

code	finishing	q.kit	q.pack	a	b	c	kg.x1	vol.x1
120307-010	● chêne/roble	x1	1	800	300	18	3,20	mc. 0.0043
120307-011	● chêne/roble	x1	1	1100	300	18	4,30	mc. 0.0059
120307-012	● chêne/roble	x1	1	1400	300	18	5,40	mc. 0.0075

12 étagère à livres
soporte libros

code	finishing	q.kit	q.pack	a	b	c	kg.x1	vol.x1
113403-403	● noir/negro	x1	1	800	363	95	3,20	mc. 0.0244
113405-403	○ blanc/blanco	x1	1	800	363	95	3,20	mc. 0.0244
113404-403	● gris/gris	x1	1	800	363	95	3,20	mc. 0.0244

13 accroche tipper - paire des accroches de jonction pour tables
gancho tipper - pareja de ganchos de unión para mesas

code	finishing	q.kit	q.pack	kg.x1
134003-223	● noir/negro	x2	20	0,005

14 paire charnières pour panneau de modestie + vis
pareja de cremalleras para tablero de cortesia + tornillos

code	finishing	q.kit
120307-017	● galvanisé/galvanizado	x1



13

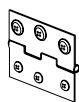

14

optionals

packaging

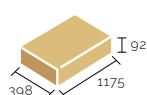

01

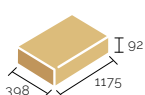

02

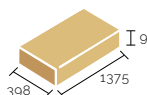

03

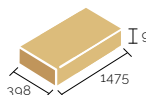

04

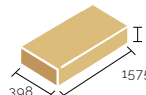

05

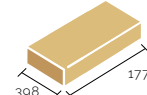

06

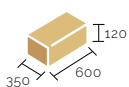

07

L 600

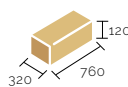

07

L 750

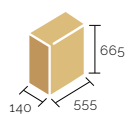

08

L 600

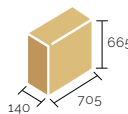

08

L 750

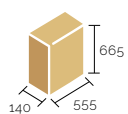

09

L 600

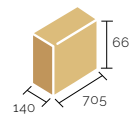

09

L 750

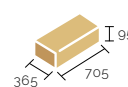

10

packaging specifications

article	version	q.pack	q.pallet	pallet size
Duo leg	600mm	2	144	800x1200x2300mm
Duo leg	750mm	2	132	800x1200x2300mm
Pro leg	600mm	2	84	1000x1200x2200mm
Pro leg	750mm	2	60	1000x1200x2200mm
Classic leg	600mm	2	84	1000x1200x2200mm
Classic leg	750mm	2	60	1000x1200x2200mm
Mechanism	1000mm	1	50	1000x1200x2050mm
Mechanism	1200mm	1	50	1000x1200x2050mm
Mechanism	1400mm	1	50	1000x1400x2050mm
Mechanism	1500mm	1	50	1000x1500x2050mm
Mechanism	1600mm	1	50	1000x1600x2050mm
Mechanism	1800mm	1	50	1000x1800x2050mm



clever



discover more about
Clever Collection

Clever, le cadre de table motorisé et réglable en hauteur (60 cm à 125 cm) qui se soucie de la santé de votre dos. Le mécanisme, précis et silencieux grâce à deux moteurs électriques synchronisés, permet de mémoriser 4 positions personnalisées sur l'écran pratique. Le robuste cadre en acier réglable en largeur (101 cm - 181 cm) garantit une adaptabilité maximale à tous les besoins. Disponible en gris et en blanc.

Clever, estructura de mesa motorizada y regulable en altura (de 60 cm a 125 cm) que se preocupa por la salud de nuestras espaldas. El mecanismo, preciso y silencioso gracias a los dos motores eléctricos sincronizados, permite memorizar 4 posiciones personalizadas en la cómoda pantalla. El robusto bastidor de acero ajustable en anchura (101 cm - 181 cm) garantiza la máxima adaptabilidad a cada necesidad. Disponible en gris y blanco.

Plus

- Poutre télescopique compatible avec un grand nombre de plateaux de table.
- Pieds télescopiques extensibles de 600 à 1250 mm.
- Réglage en hauteur par écran à 4 mémoires par deux moteurs électriques synchronisés.
- En option: support d'unité centrale.
- *Viga telescópica compatible con un gran número de tableros de mesa.*
- *Patatas telescópicas extensibles de 600 a 1250 mm.*
- *Altura regulable mediante pantalla de 4 memorias por 2 motores eléctricos sincronizados.*
- *Opcional: soporte para CPU.*

clever

components

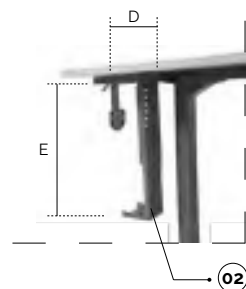
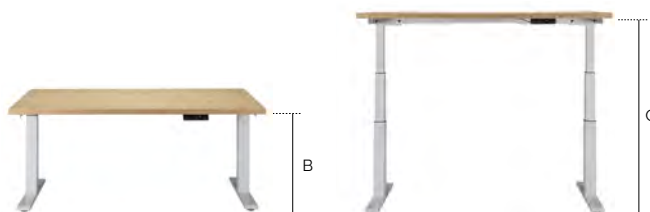
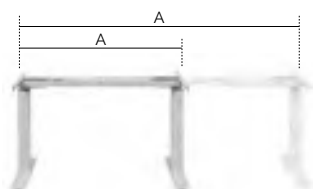
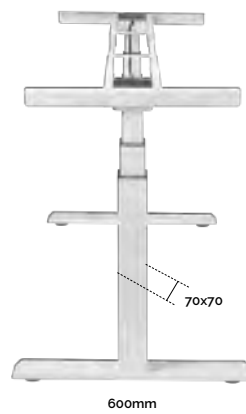
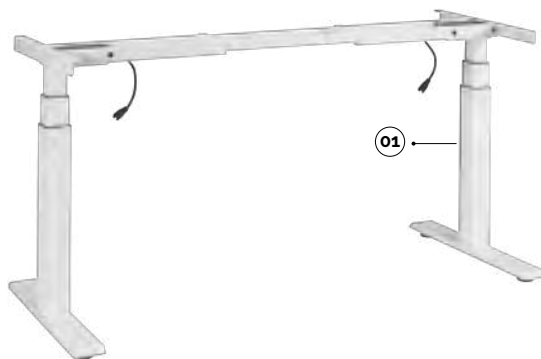

01 clever - table électrique réglable en hauteur
clever - mesa eléctrica regulable en altura

code	finishing		q.kit	q.pack	a	b	c	kg.x1	vol.x1
110304-102	● gris/gris	ral 7045	x1	1	1010-1810	600	1250	29,00	mc. 0,063
110305-102	○ blanc/blanco	ral 9016	x1	1	1010-1810	600	1250	29,00	mc. 0,063

02 clever - support pour processeur
clever - soporte para CPU

code	finishing		q.kit	q.pack	d	e	kg.x1	vol.x1
110304-103	● gris/gris	ral 7045	x1	1	80-220	325-555	2,85	mc. 0,020
110305-103	○ blanc/blanco	ral 9016	x1	1	80-220	325-555	2,85	mc. 0,020

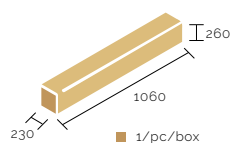

01

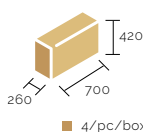

02





Frame width adjustable



Electric height-adjustable frame

Height range	60 cm → 125 cm
Load capacity	100 kg
Frame width adjustable	101 cm → 181 cm
Desktop sizes compatibility	110x60 cm → 240x120 cm
Travel speed	38 mm per seconds
Frame color	Grey RAL 7045 / White RAL 9016
Synchronized motors	2
Legs stage	3
Handset	Digital display & 4 preset buttons





contract tables

maui coffee table
riace collection



discover more about
Maui Coffee table



discover more about
Riace Collection

Contract Tables comprennent la table basse Maui et la collection Riace, une gamme de tables et de tables basses idéales pour tous les espaces, en particulier les environnements Ho.Re.Ca. et domestiques, grâce à la polyvalence assurée par sa large gamme de formats et de tailles. De multiples finitions sont également disponibles pour les plateaux et les cadres métalliques.

Contract Tables incluye la mesa de centro Maui y la colección Riace, una gama de mesas y mesitas ideales para cualquier espacio, especialmente para los entornos Ho.Re.Ca. y domésticos, gracias a la versatilidad que asegura su amplia gama de formatos y tamaños. Además, existen numerosos acabados disponibles para los tableros y las estructuras metálicas.

Plus

- Idéal pour les environnements contractuels et résidentiels, d'hôtellerie et domestiques.
- Structures disponibles en 3 hauteurs et tailles différentes.
- Bases et colonnes disponibles en sections carrées ou rondes.
- *Ideal para entornos contractuales, residenciales, hosteleros y domésticos.*
- *Estructuras disponibles en 3 alturas y tamaños diferentes.*
- *Bases y columnas disponibles en en sección cuadrada o redonda.*



designed by:
R&D Alba

maui

metal rod
coffee table

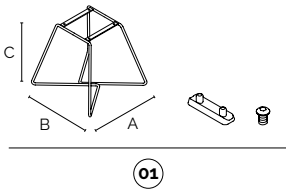
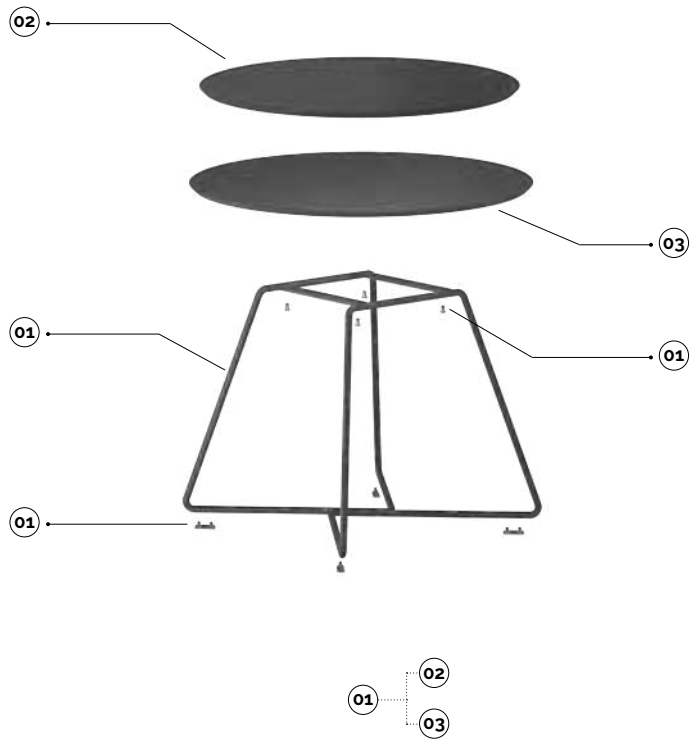

01

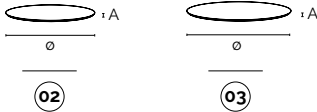

02

03

01 base de tige - accessoires: pieds, vis pour le dessus
base de varilla - accesorios: patas, tornillos para tapa

code	finishing	q.kit	q.pack	a	b	c	kg.x1	vol.x1
110303-706	● noir/negro	x1	30	447	455	408	3.55	mc. 0.1232
110304-705	● gris/gris	x1	30	447	455	408	3.55	mc. 0.1232
110305-705	● ivoire/marfil	x1	30	447	455	408	3.55	mc. 0.1232
110310-706	● chromé/cromado	x1	30	447	455	408	3.55	mc. 0.1232

02 plateau rond Ø590
tapa redonda Ø590

code	finishing	q.kit	q.pack	ø	a	kg.x1	vol.x1
120303-021	● noir/negro outdoor/indoor	x1	1	590	10	4.00	mc. 0.0072
120305-021	● ivoire/marfil outdoor/indoor	x1	1	590	10	4.00	mc. 0.0072

03 plateau rond Ø690
tapa redonda Ø690

code	finishing	q.kit	q.pack	ø	a	kg.x1	vol.x1
120303-022	● noir/negro outdoor/indoor	x1	1	690	10	5.70	mc. 0.0098
120305-022	● ivoire/marfil outdoor/indoor	x1	1	690	10	5.70	mc. 0.0098

main component sizes

riace

square low table

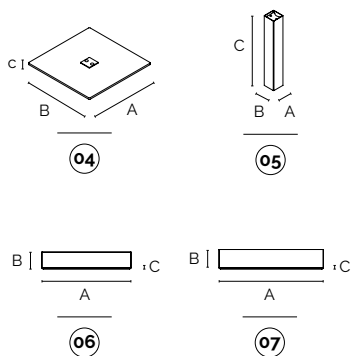
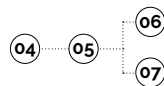
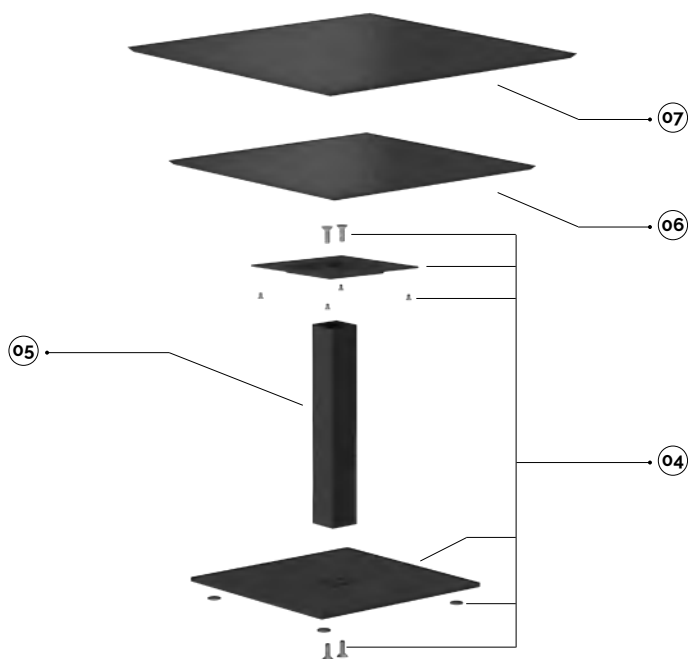

04 base carrée + plaque de fixation du plateau + feutres + vis pour colonne + vis pour plateau
base cuadrada + placa para fijación de la encimera + almohadillas de fieltro + tornillos para columna + tornillos para encimera

code	finishing	q.kit	q.pack	a	b	c	kg.x1	vol.x1
110303-292	● noir/negro	x1	1	390	390	8	10.65	mc. 0.0089
110304-282	● gris/gris	x1	1	390	390	8	10.65	mc. 0.0089
110305-282	● ivoire/marfil	x1	1	390	390	8	10.65	mc. 0.0089

05 colonne de table basse à section carrée
columna para mesa de café de sección cuadrada

code	finishing	q.kit	q.pack	a	b	c	kg.x1	vol.x1
110303-293	● noir/negro	x1	1	60	60	378	1.46	mc. 0.0043
110304-283	● gris/gris	x1	1	60	60	378	1.46	mc. 0.0043
110305-283	● ivoire/marfil	x1	1	60	60	378	1.46	mc. 0.0043

06 plateau carré 590x590
tapa cuadrada 590x590

code	finishing	q.kit	q.pack	a	b	c	kg.x1	vol.x1	
120303-024	● noir/negro	outdoor/indoor	x1	1	590	590	10	5.70	mc. 0.0072
120305-024	● ivoire/marfil	outdoor/indoor	x1	1	590	590	10	5.70	mc. 0.0072

07 plateau carré 690x690
tapa cuadrada 690x690

code	finishing	q.kit	q.pack	a	b	c	kg.x1	vol.x1	
120303-025	● noir/negro	outdoor/indoor	x1	1	690	690	10	7.80	mc. 0.0098
120305-025	● ivoire/marfil	outdoor/indoor	x1	1	690	690	10	7.80	mc. 0.0098

main component sizes

riace

round low table

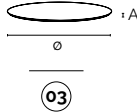
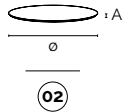
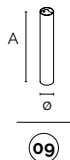
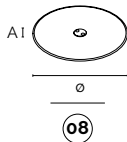
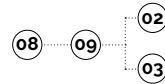
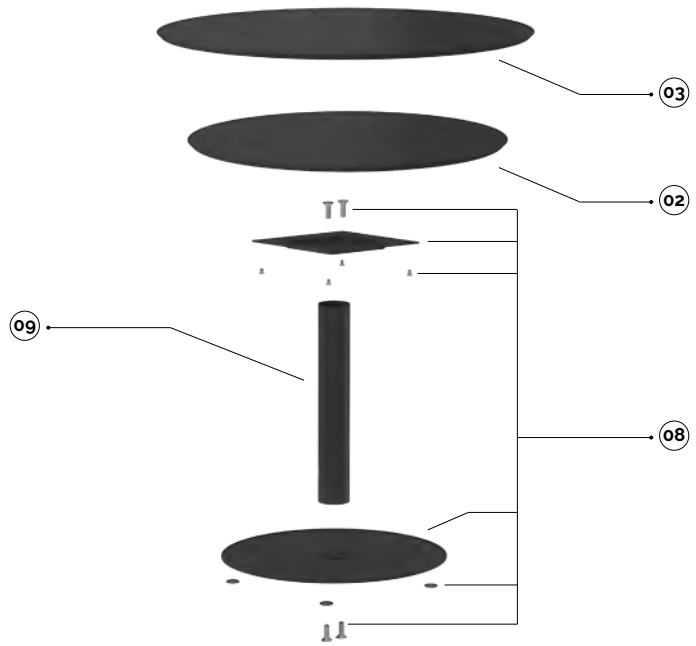

main component sizes

08 base ronde • plaque de fixation du plateau • feutres • vis pour colonne • vis pour plateau
base redonda + placa para fijación de la encimera + almohadillas de fieltro + tornillos para columna + tornillos para encimera

code	finishing	q.kit	q.pack	ø	a	kg.x1	vol.x1
110303-290	● noir/negro	x1	1	420	6	8.42	mc. 0.0089
110304-280	● gris/gris	x1	1	420	6	8.42	mc. 0.0089
110305-280	● ivoire/marfil	x1	1	420	6	8.42	mc. 0.0089

09 colonne de table basse à section ronde
columna para mesa de café de sección redonda

code	finishing	q.kit	q.pack	ø	a	kg.x1	vol.x1
110303-291	● noir/negro	x1	1	60	380	1.20	mc. 0.0043
110304-281	● gris/gris	x1	1	60	380	1.20	mc. 0.0043
110305-281	● ivoire/marfil	x1	1	60	380	1.20	mc. 0.0043

02 plateau rond Ø590
tapa redonda Ø590

code	finishing	q.kit	q.pack	ø	a	kg.x1	vol.x1
120303-021	● noir/negro outdoor/indoor	x1	1	590	10	4.00	mc. 0.0072
120305-021	● ivoire/marfil outdoor/indoor	x1	1	590	10	4.00	mc. 0.0072

03 plateau rond Ø690
tapa redonda Ø690

code	finishing	q.kit	q.pack	ø	a	kg.x1	vol.x1
120303-022	● noir/negro outdoor/indoor	x1	1	690	10	5.70	mc. 0.0098
120305-022	● ivoire/marfil outdoor/indoor	x1	1	690	10	5.70	mc. 0.0098

riace

square medium table

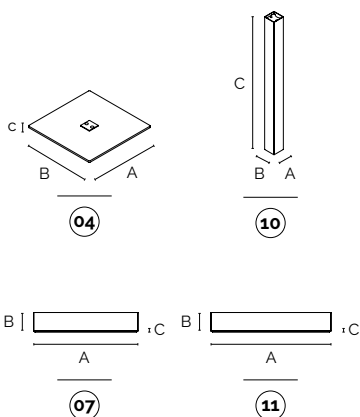
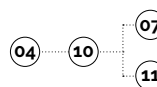
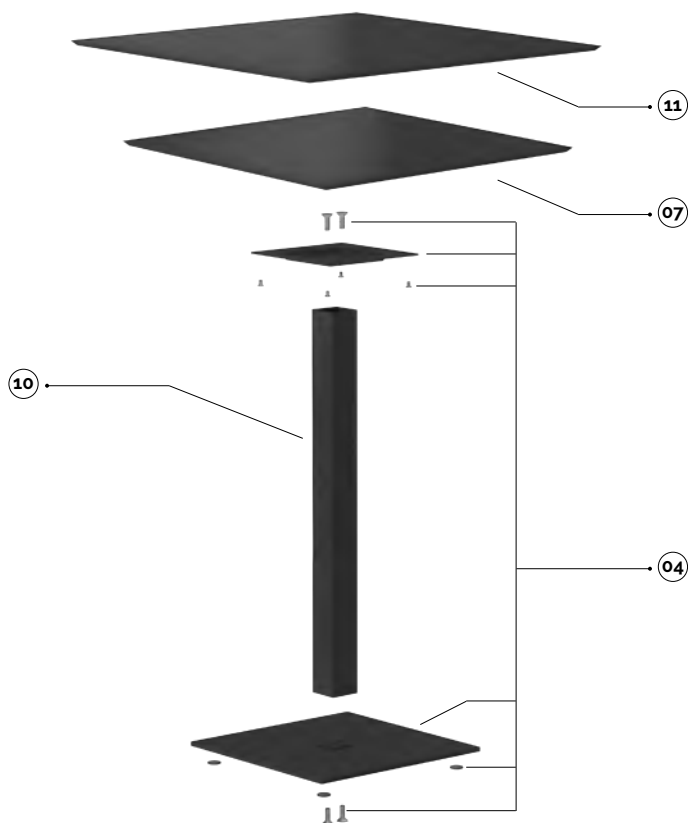

04 base carrée + plaque de fixation du plateau + feutres + vis pour colonne + vis pour plateau
base cuadrada + placa para fijación de la encimera + almohadillas de fieltro + tornillos para columna + tornillos para encimera

code	finishing	q.kit	q.pack	a	b	c	kg.x1	vol.x1
110303-292	● noir/negro	x1	1	390	390	8	10,65	mc. 0,0089
110304-282	● gris/gris	x1	1	390	390	8	10,65	mc. 0,0089
110305-282	● ivoire/marfil	x1	1	390	390	8	10,65	mc. 0,0089

10 colonne moyenne à section carrée
columna media de sección cuadrada

code	finishing	q.kit	q.pack	a	b	c	kg.x1	vol.x1
110303-295	● noir/negro	x1	1	60	60	720	2,72	mc. 0,0043
110304-285	● gris/gris	x1	1	60	60	720	2,72	mc. 0,0043
110305-285	● ivoire/marfil	x1	1	60	60	720	2,72	mc. 0,0043

07 plateau carré 690x690
tapa cuadrada 690x690

code	finishing	q.kit	q.pack	a	b	c	kg.x1	vol.x1
120303-025	● noir/negro	x1	1	690	690	10	7,80	mc. 0,0098
120305-025	● ivoire/marfil	x1	1	690	690	10	7,80	mc. 0,0098

11 plateau carré 790x790
tapa cuadrada 790x790

code	finishing	q.kit	q.pack	a	b	c	kg.x1	vol.x1
120303-026	● noir/negro	x1	1	790	790	10	10,70	mc. 0,0128
120305-026	● ivoire/marfil	x1	1	790	790	10	10,70	mc. 0,0128

main component sizes

riace

round medium table

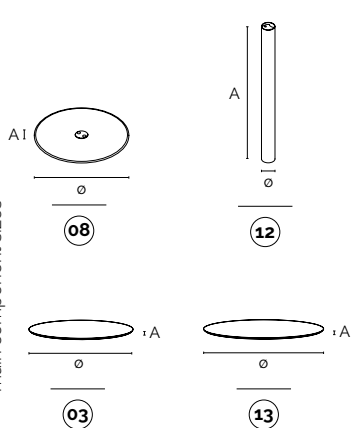
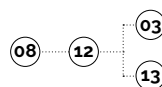
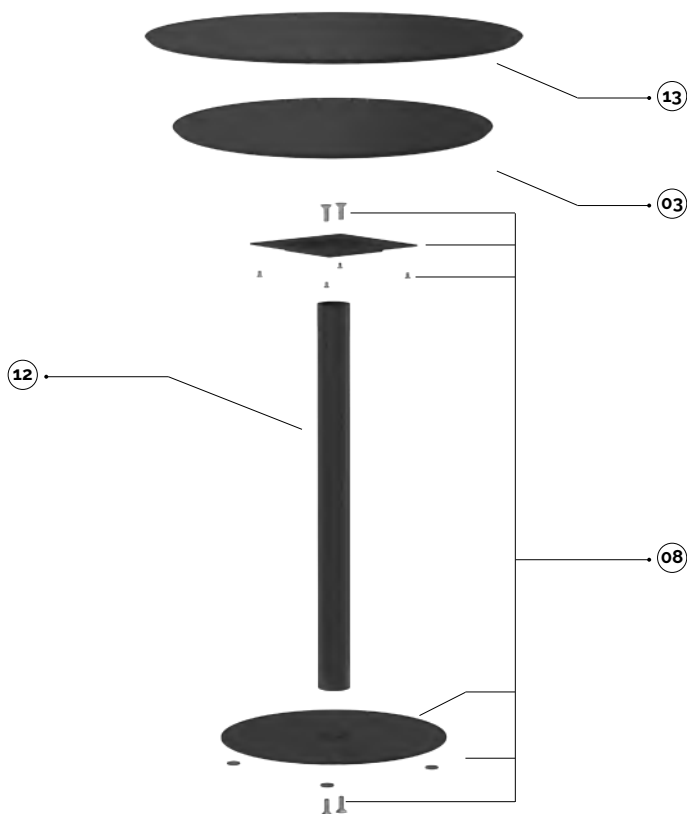

08 base ronde + plaque de fixation du plateau + feutres + vis pour colonne + vis pour plateau
base redonda + placa para fijación de la encimera + almohadillas de fieltro + tornillos para columna + tornillos para encimera

code	finishing	q.kit	q.pack	ø	a	kg.x1	vol.x1
110303-290	● noir/negro	x1	1	420	6	8.42	mc. 0.0089
110304-280	● gris/gris	x1	1	420	6	8.42	mc. 0.0089
110305-280	● ivoire/marfil	x1	1	420	6	8.42	mc. 0.0089

12 colonne moyenne à section ronde
columna media de sección redonda

code	finishing	q.kit	q.pack	ø	a	kg.x1	vol.x1
110303-294	● noir/negro	x1	1	60	722	1.92	mc. 0.0043
110304-284	● gris/gris	x1	1	60	722	1.92	mc. 0.0043
110305-284	● ivoire/marfil	x1	1	60	722	1.92	mc. 0.0043

03 plateau rond Ø690
tapa redonda Ø690

code	finishing	q.kit	q.pack	ø	a	kg.x1	vol.x1
120303-022	● noir/negro	outdoor/indoor	x1	1	690 10	5.70	mc. 0.0098
120305-022	● ivoire/marfil	outdoor/indoor	x1	1	690 10	5.70	mc. 0.0098

13 plateau rond Ø790
tapa redonda Ø790

code	finishing	q.kit	q.pack	ø	a	kg.x1	vol.x1
120303-023	● noir/negro	outdoor/indoor	x1	1	790 10	8.40	mc. 0.0128
120305-023	● ivoire/marfil	outdoor/indoor	x1	1	790 10	8.40	mc. 0.0128

riace

rectangular medium table

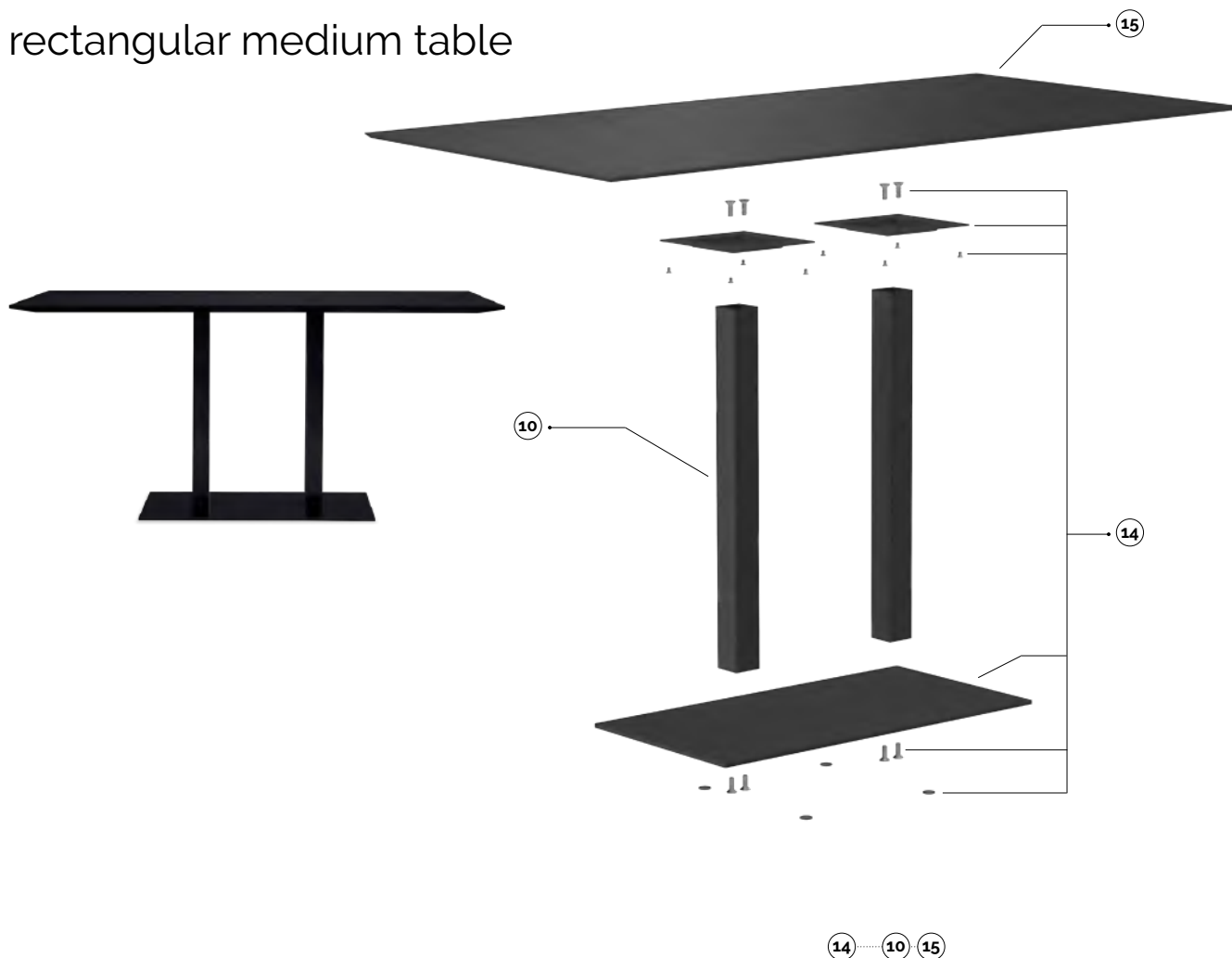

main component sizes

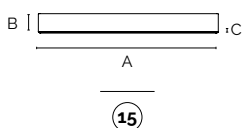
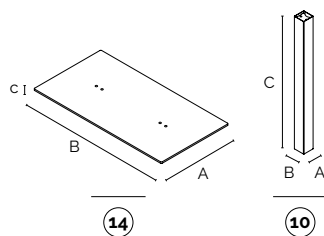

14 base rectangulaire + plaque de fixation du plateau + feutres + vis pour colonne + vis pour plateau
base rectangular + placa para fijación de la encimera + almohadillas de fieltro + tornillos para columna + tornillos para encimera

code	finishing	q.kit	q.pack	a	b	c	kg.x1	vol.x1
110303-288	● noir/negro	x1	1	800	420	8	23,5	mc. 0.018
110304-288	● gris/gris	x1	1	800	420	8	23,5	mc. 0.018
110305-288	● ivoire/marfil	x1	1	800	420	8	23,5	mc. 0.018

10 colonne moyenne à section carrée
columna media de sección cuadrada

code	finishing	q.kit	q.pack	a	b	c	kg.x1	vol.x1
110303-295	● noir/negro	x2	1	60	60	720	2,72	mc. 0.0043
110304-285	● gris/gris	x2	1	60	60	720	2,72	mc. 0.0043
110305-285	● ivoire/marfil	x2	1	60	60	720	2,72	mc. 0.0043

15 plateau rectangulaire 1590x790
tapa rectangular 1590x790

code	finishing		q.kit	q.pack	a	b	c	kg.x1	vol.x1
120303-027	● noir/negro	outdoor/indoor	x1	1	1590	790	10	13,5	mc. 0.0168
120305-027	● ivoire/marfil	outdoor/indoor	x1	1	1590	790	10	13,5	mc. 0.0168

riace

square high table

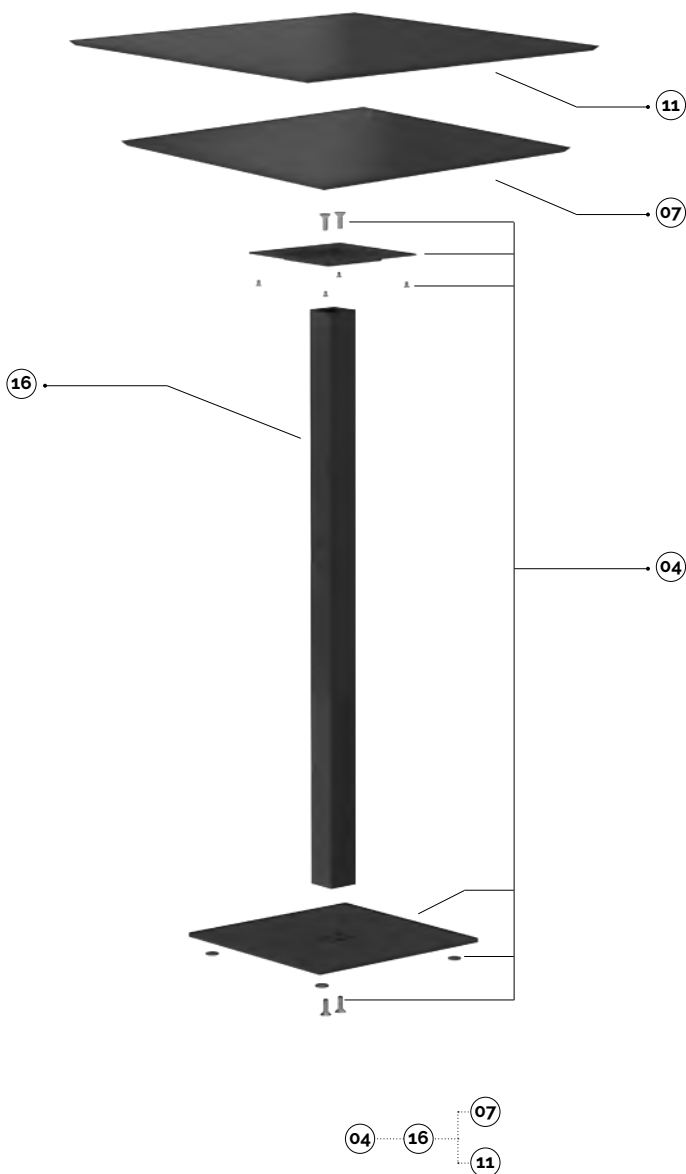

main component sizes

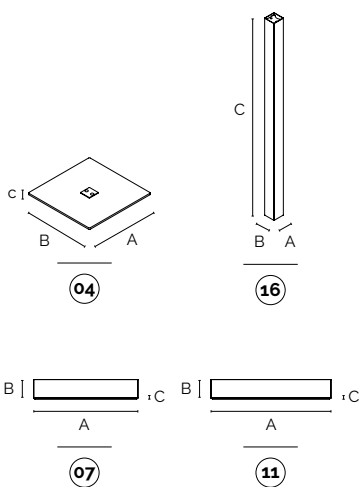

04 base carrée + plaque de fixation du plateau + feutres + vis pour colonne + vis pour plateau
base cuadrada + placa para fijación de la encimera + almohadillas de fieltro + tornillos para columna + tornillos para encimera

code	finishing	q.kit	q.pack	a	b	c	kg.x1	vol.x1
110303-292	● noir/negro	x1	1	390	390	8	10.65	mc. 0.008g
110304-282	● gris/gris	x1	1	390	390	8	10.65	mc. 0.008g
110305-282	● ivoire/marfil	x1	1	390	390	8	10.65	mc. 0.008g

16 colonne haute à section carrée
columna alta de sección cuadrada

code	finishing	q.kit	q.pack	a	b	c	kg.x1	vol.x1
110303-297	● noir/negro	x1	1	60	60	1070	3.30	mc. 0.006
110304-287	● gris/gris	x1	1	60	60	1070	3.30	mc. 0.006
110305-287	● ivoire/marfil	x1	1	60	60	1070	3.30	mc. 0.006

07 plateau carré 690x690
tapa cuadrada 690x690

code	finishing	usage	q.kit	q.pack	a	b	c	kg.x1	vol.x1
120303-025	● noir/negro	outdoor/indoor	x1	1	690	690	10	7.80	mc. 0.0098
120305-025	● ivoire/marfil	outdoor/indoor	x1	1	690	690	10	7.80	mc. 0.0098

11 plateau carré 790x790
tapa cuadrada 790x790

code	finishing	usage	q.kit	q.pack	a	b	c	kg.x1	vol.x1
120303-026	● noir/negro	outdoor/indoor	x1	1	790	790	10	10.70	mc. 0.0128
120305-026	● ivoire/marfil	outdoor/indoor	x1	1	790	790	10	10.70	mc. 0.0128

riace

round high table

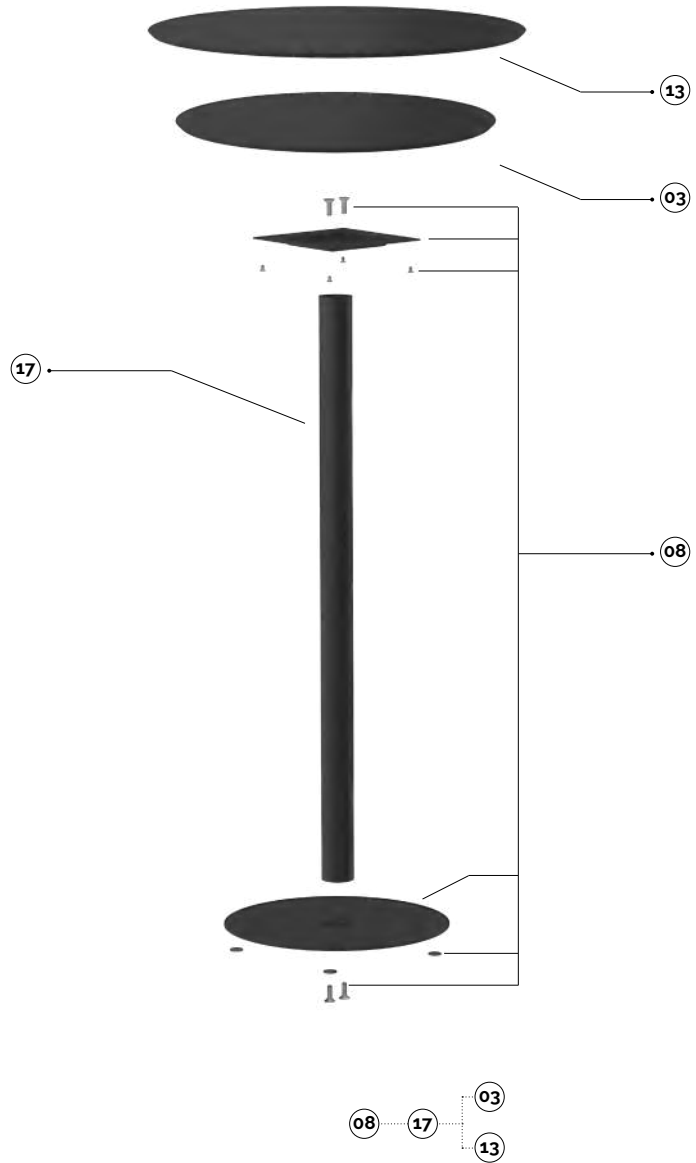

main component sizes

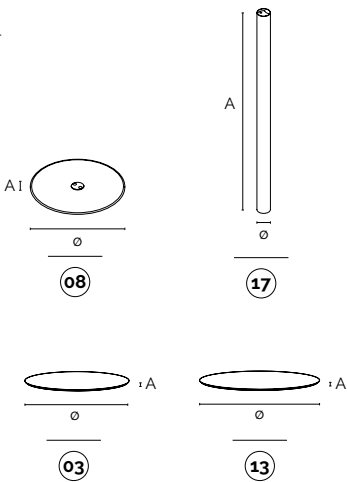

08 base ronde + plaque de fixation du plateau + feutres + vis pour colonne + vis pour plateau
base redonda + placa para fijación de la encimera + almohadillas de fieltro + tornillos para columna + tornillos para encimera

code	finishing	q.kit	q.pack	o	a	kg.x1	vol.x1
110303-290	● noir/negro	x1	1	420	6	8.42	mc. 0.0089
110304-280	● gris/gris	x1	1	420	6	8.42	mc. 0.0089
110305-280	● ivoire/marfil	x1	1	420	6	8.42	mc. 0.0089

17 colonne haute à section ronde
columna alta de sección cuadrada

code	finishing	q.kit	q.pack	o	a	kg.x1	vol.x1
110303-296	● noir/negro	x1	1	60	1072	2.72	mc. 0.006
110304-286	● gris/gris	x1	1	60	1072	2.72	mc. 0.006
110305-286	● ivoire/marfil	x1	1	60	1072	2.72	mc. 0.006

03 plateau rond Ø690
tapa redonda Ø690

code	finishing	q.kit	q.pack	o	a	kg.x1	vol.x1
120303-022	● noir/negro outdoor/indoor	x1	1	690	10	5.70	mc. 0.0098
120305-022	● ivoire/marfil outdoor/indoor	x1	1	690	10	5.70	mc. 0.0098

13 plateau rond Ø790
tapa redonda Ø790

code	finishing	q.kit	q.pack	o	a	kg.x1	vol.x1
120303-023	● noir/negro outdoor/indoor	x1	1	790	10	8.40	mc. 0.0128
120305-023	● ivoire/marfil outdoor/indoor	x1	1	790	10	8.40	mc. 0.0128

riace

rectangular high table

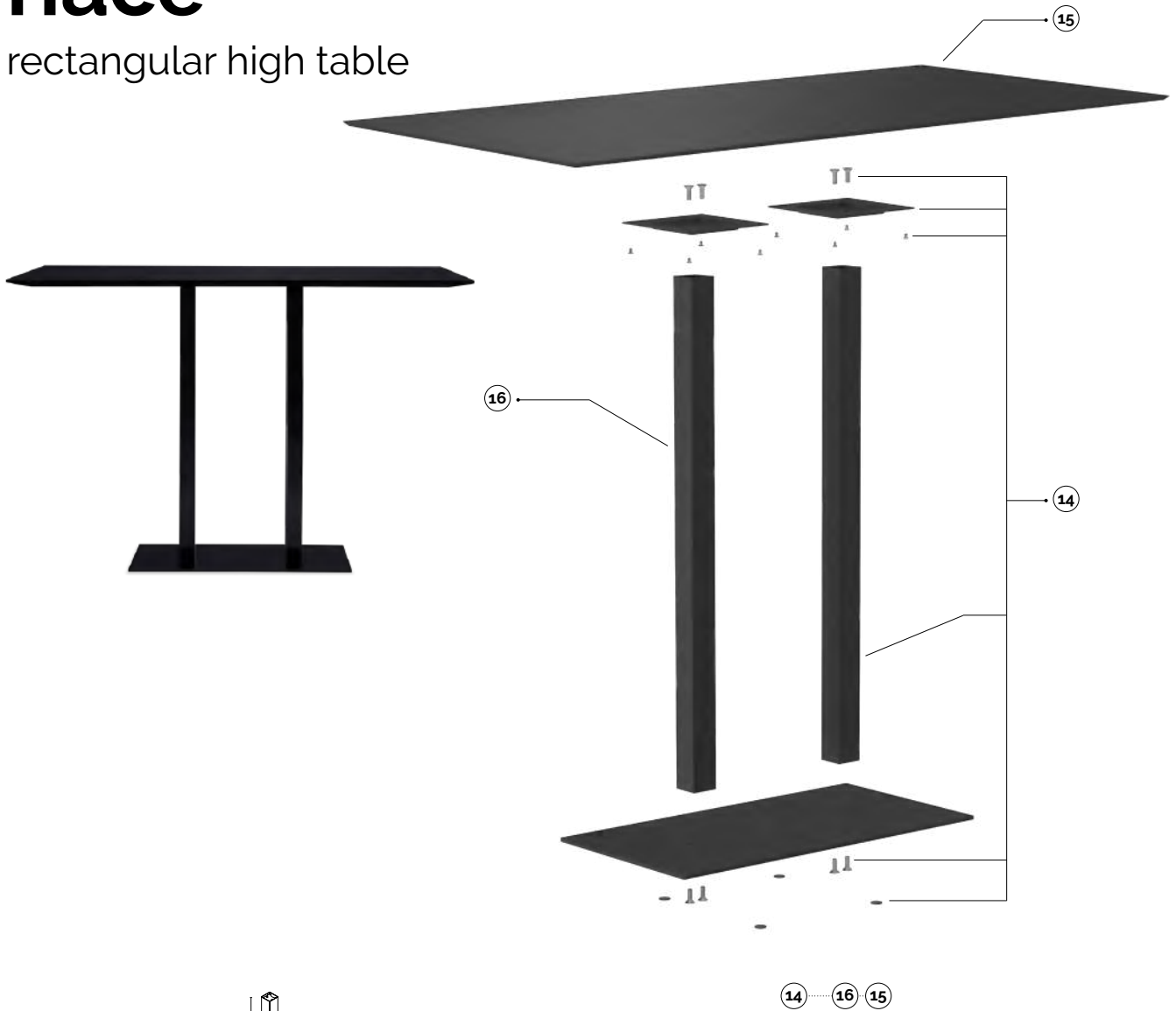

main component sizes

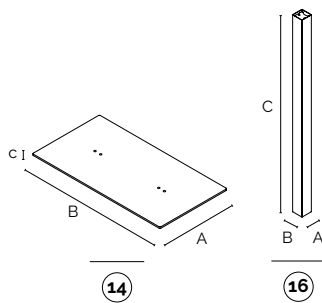

14

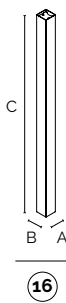

16

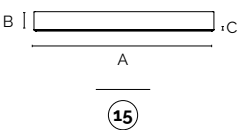

15

14 16 15

14 base rectangulaire + plaque de fixation du plateau + feutres + vis pour colonne + vis pour plateau
base rectangular + placa para fijación de la encimera + almohadillas de fieltro + tornillos para columna + tornillos para encimera

code	finishing	q.kit	q.pack	a	b	c	kg.x1	vol.x1
110303-288	● noir/negro	x1	1	800	420	8	23,5	mc. 0.018
110304-288	● gris/gris	x1	1	800	420	8	23,5	mc. 0.018
110305-288	● ivoire/marfil	x1	1	800	420	8	23,5	mc. 0.018

16 colonne haute à section carrée
columna alta de sección cuadrada

code	finishing	q.kit	q.pack	a	b	c	kg.x1	vol.x1
110303-297	● noir/negro	x2	1	60	60	1070	3,30	mc. 0.006
110304-287	● gris/gris	x2	1	60	60	1070	3,30	mc. 0.006
110305-287	● ivoire/marfil	x2	1	60	60	1070	3,30	mc. 0.006

15 plateau rectangulaire 1590x790
tapa rectangular 1590x790

code	finishing	usage	q.kit	q.pack	a	b	c	kg.x1	vol.x1
120303-027	● noir/negro	outdoor/indoor	x1	1	1590	790	10	13,5	mc. 0.0168
120305-027	● ivoire/marfil	outdoor/indoor	x1	1	1590	790	10	13,5	mc. 0.0168





tapas



discover more about
Tapas Collection

Une nouvelle ligne pour le secteur Ho.re.ca. Cette collection innovante et complète se compose de deux familles.

La première, permet une utilisation indoor & outdoor, elle est totalement démontable, facile à assembler et de grande solidité, avec un design fonctionnel et polyvalent grâce aux nombreuses finitions proposées.

La deuxième a été exclusivement conçue pour l'outdoor, avec des châssis spécifiques et des finitions de matériaux parfaites pour ce type d'utilisation.

Tapas est idéale pour un environnement professionnel.

La nueva línea para el canal Ho.re.ca. Una colección innovadora y completa, articulada en dos familias.

La primera de ellas, destinada al uso en el interior y el exterior, se desmonta completamente, es práctica de ensamblar y sumamente sólida, con un diseño funcional y versátil por sus numerosas variantes de acabado. La segunda se ha pensado específicamente para el exterior, con bastidores dedicados y acabados ideales de los materiales para este tipo de utilización.

Tapas es ideal para el ambiente Contract.

Plus

- De nombreuses finitions proposées.
- Une polyvalence d'utilisation grâce aux finitions spécifiques proposées pour l'outdoor.
- Les kits de la famille indoor & outdoor prévoient un emballage démonté afin de réduire les coûts de manutention.
- Une simplicité d'assemblage.
- Tabourets certifiés EN 16139:2013+AC2013 Niveau 2.
- Tables certifiées EN 15372:2016. Niveau 2.
- Numerosas variantes de acabado.
- Utilización versátil con los acabados específicos para el exterior.
- Los kits de la familia para el interior y el exterior contemplan un embalaje desmontado para reducir los costes de manipulación.
- Ensamblaje sencillo.
- Taburetes certificados EN 16139:2013+AC2013 Nivel 2.
- Mesas certificadas según EN 15372:2016 Nivel 2.



designed by:
Edi & Paolo Ciani Design



**outdoor
ready**



**UV plastic
protection**

tapas

stool

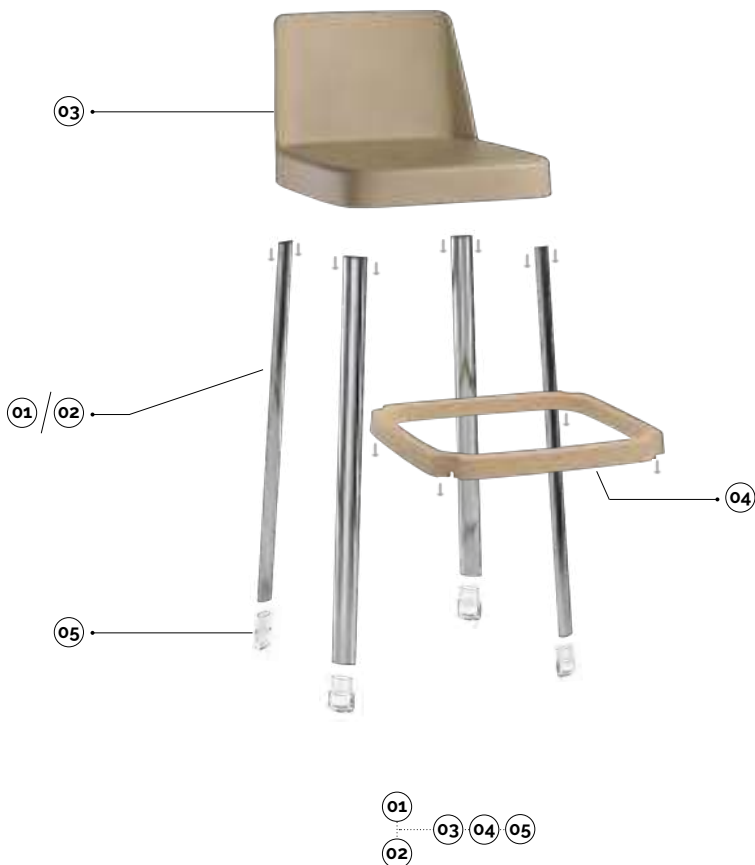

plastic colours

- ivoire/marfil ral1013
- noisette/avellana 2312u
- gris/gris ig2621
- noir/negro ral9005

Corten *Une caractéristique spécifique du Corten est la variabilité dans la tonalité de la finition.
* Una característica particular del Corten es las variabilidad en la tonalidad del acabado.

main component sizes

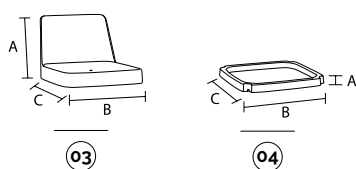
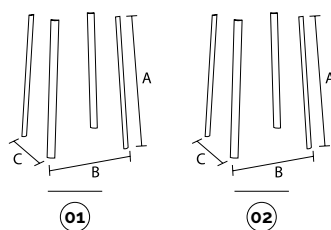

01 tapas-tabouret h650 kit n°4 pieds avec vis tapas-taburete h650 kit n°4 patas con tornillos

code	finishing	q.kit	q.pack	a	b	c	kg.x1	vol.x1
110603-637	● noir/negro	x1	5	650	410	410	3.54	mc. 0.0035
110604-637	● gris/gris ig2621	x1	5	650	410	410	3.54	mc. 0.0035
110605-637	● ivoire/marfil ral 1013	x1	5	650	410	410	3.54	mc. 0.0035
110607-637	● corten*	x1	5	650	410	410	3.54	mc. 0.0035
110610-637	● chromé/cromado	x1	5	650	410	410	3.54	mc. 0.0035
110603-638	● noir/negro *pour extérieur/para exterior	x1	5	650	410	410	3.54	mc. 0.0035
110604-638	● gris/gris ig2621 *pour extérieur/para exterior	x1	5	650	410	410	3.54	mc. 0.0035
110605-638	● ivoire/marfil ral 1013 *pour extérieur/para exterior	x1	5	650	410	410	3.54	mc. 0.0035
110607-638	● corten* *pour extérieur/para exterior	x1	5	650	410	410	3.54	mc. 0.0035

02 tapas-tabouret h750 kit n°4 pieds avec vis tapas-taburete h750 kit n°4 patas con tornillos

code	finishing	q.kit	q.pack	a	b	c	kg.x1	vol.x1
110603-635	● noir/negro	x1	5	750	422	422	3.54	mc. 0.0035
110604-635	● gris/gris ig2621	x1	5	750	422	422	3.54	mc. 0.0035
110605-635	● ivoire/marfil ral 1013	x1	5	750	422	422	3.54	mc. 0.0035
110607-635	● corten*	x1	5	750	422	422	3.54	mc. 0.0035
110610-635	● chromé/cromado	x1	5	750	422	422	3.54	mc. 0.0035
110603-636	● noir/negro *pour extérieur/para exterior	x1	5	750	422	422	3.54	mc. 0.0035
110604-636	● gris/gris ig2621 *pour extérieur/para exterior	x1	5	750	422	422	3.54	mc. 0.0035
110605-636	● ivoire/marfil ral 1013 *pour extérieur/para exterior	x1	5	750	422	422	3.54	mc. 0.0035
110607-636	● corten* *pour extérieur/para exterior	x1	5	750	422	422	3.54	mc. 0.0035

03 tapas-coque en plastique pour tabouret tapas-carcasa de plástico para taburete

code	finishing	q.kit	q.pack	a	b	c	kg.x1	vol.x1
130603-003	● noir/negro	x1	5	276	382	458	2.06	mc. 0.02045
130604-001	● gris/gris 650	x1	5	276	382	458	2.06	mc. 0.02045
130605-003	● ivoire/marfil ral 1013	x1	5	276	382	458	2.06	mc. 0.02045
130607-003	● noisette/avellana 2312u	x1	5	276	382	458	2.06	mc. 0.02045

04 tapas-repose-pieds pour tabouret tapas-reposapiés para taburete

code	finishing	q.kit	a	b	c	kg.x1		
130603-000	● noir/negro	x1	5	34	417	417	0.874	mc. 0.01092
130604-000	● gris/gris 650	x1	5	34	417	417	0.874	mc. 0.01092
130605-002	● ivoire/marfil ral 1013	x1	5	34	417	417	0.874	mc. 0.01092
130607-000	● noisette/avellana 2312u	x1	5	34	417	417	0.874	mc. 0.01092

05 tapas-pied elliptique 40x20 h30 tapas-tapón elíptico 40x20 h30

code	finishing	q.kit	kg.x1	
134303-045	● noir/negro	x4	0.0174	mc. 0.00003
134306-005	○ transparent/transparente	x4	0.0174	mc. 0.00003

tapas

high table

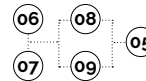
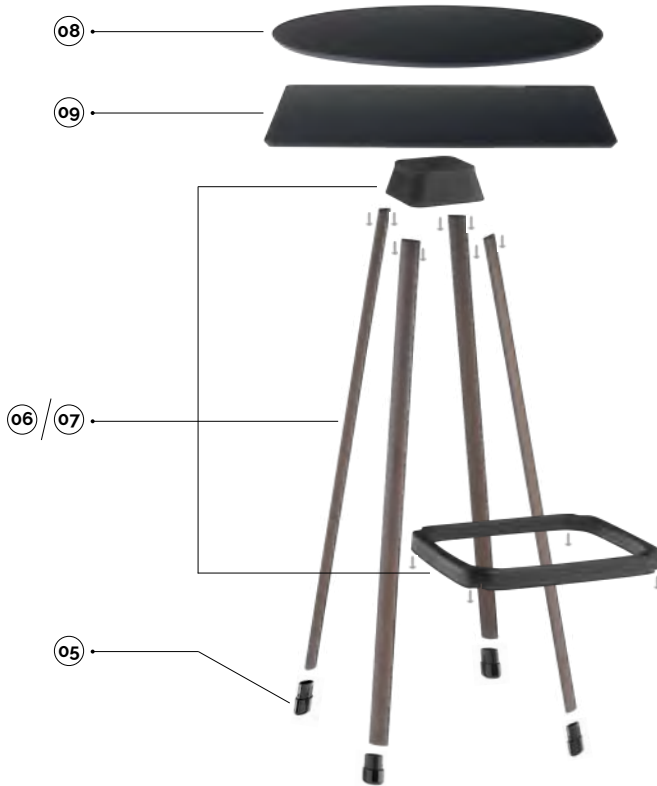

On recommande les suivantes
mesures des plateaux:
Se recomiendan las siguientes
medidas de tableros:

- high table: 590 / 690 mm

plastic colours

- ivoire/marfil ral1013
- noir/negro ral9005

Corten
• *Une caractéristique spécifique du Corten est la variabilité dans la tonalité de la finition.
* Una característica particular del Corten es las variabilidad en la tonalidad del acabado.

main component sizes

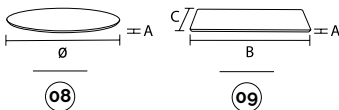
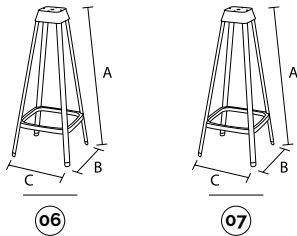

06 tapas-kit piètements table haute avec vis + support + repose-pieds ivoire r1013

tapas-kit patas mesa alta con tornillos + soporte + reposapiés marfil r1013

code	finishing	q.kit	q.pack	a	b	c	kg.x1	vol.x1
110303-244	● noir/negro	x1	2	1085	453	453	8,0	mc. 0.02365
110304-244	● gris/gris ig2621	x1	2	1085	453	453	8,0	mc. 0.02365
110305-244	● ivoire/marfil ral 1013	x1	2	1085	453	453	8,0	mc. 0.02365
110307-244	● corten*	x1	2	1085	453	453	8,0	mc. 0.02365
110310-244	● chromé/cromado	x1	2	1085	453	453	8,0	mc. 0.02365
110303-246	● noir/negro *pour extérieur/para exterior	x1	2	1085	453	453	8,0	mc. 0.02365
110304-246	● gris/gris ig2621 *pour extérieur/para exterior	x1	2	1085	453	453	8,0	mc. 0.02365
110305-246	● ivoire/marfil ral 1013 *pour extérieur/para exterior	x1	2	1085	453	453	8,0	mc. 0.02365
110307-246	● corten* *pour extérieur/para exterior	x1	2	1085	453	453	8,0	mc. 0.02365

07 tapas-kit piètements table haute avec vis + support + repose-pieds noir

tapas-kit patas mesa alta con tornillos + soporte + reposapiés negro

code	finishing	q.kit	q.pack	a	b	c	kg.x1	vol.x1
110303-245	● noir/negro	x1	2	1085	453	453	8,0	mc. 0.02365
110304-245	● gris/gris ig2621	x1	2	1085	453	453	8,0	mc. 0.02365
110305-245	● ivoire/marfil ral 1013	x1	2	1085	453	453	8,0	mc. 0.02365
110307-245	● corten*	x1	2	1085	453	453	8,0	mc. 0.02365
110310-245	● chromé/cromado	x1	2	1085	453	453	8,0	mc. 0.02365
110303-247	● noir/negro *pour extérieur/para exterior	x1	2	1085	453	453	8,0	mc. 0.02365
110304-247	● gris/gris ig2621 *pour extérieur/para exterior	x1	2	1085	453	453	8,0	mc. 0.02365
110305-247	● ivoire/marfil ral 1013 *pour extérieur/para exterior	x1	2	1085	453	453	8,0	mc. 0.02365
110307-247	● corten* *pour extérieur/para exterior	x1	2	1085	453	453	8,0	mc. 0.02365

08 tapas-plateau rond + vis

tapas-sobre redondo + tornillos

code	finishing	q.kit	q.pack	a	ø	kg.x1	vol.x1
120303-021	● noir/negro	x1	5	10	590	4,8	mc. 0.0072
120303-022	● noir/negro	x1	5	10	690	6,6	mc. 0.0098
120303-023	● noir/negro	x1	5	10	790	8,4	mc. 0.0128
120305-021	● ivoire/marfil ral 1013	x1	5	10	590	4,8	mc. 0.0072
120305-022	● ivoire/marfil ral 1013	x1	5	10	690	6,6	mc. 0.0098
120305-023	● ivoire/marfil ral 1013	x1	5	10	790	8,4	mc. 0.0128

09 tapas-plateau carré + vis

tapas-sobre cuadrado + tornillos

code	finishing	q.kit	q.pack	a	b	c	kg.x1	vol.x1
120303-024	● noir/negro	x1	5	10	590	590	6,0	mc. 0.0072
120303-025	● noir/negro	x1	5	10	690	690	8,2	mc. 0.0098
120303-026	● noir/negro	x1	5	10	790	790	10,7	mc. 0.0128
120305-024	● ivoire/marfil ral 1013	x1	5	10	590	590	6,0	mc. 0.0072
120305-025	● ivoire/marfil ral 1013	x1	5	10	690	690	8,2	mc. 0.0098
120305-026	● ivoire/marfil ral 1013	x1	5	10	790	790	10,7	mc. 0.0128

05 tapas-pied elliptique 40x20 h30

tapas-tapón elíptico 40x20 h30

code	finishing	q.kit	kg.x1
134303-045	● noir/negro	x4	0,0174 mc. 0.00003
134306-005	○ transparent/transparente	x4	0,0174 mc. 0.00003



tapas

low table

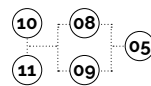
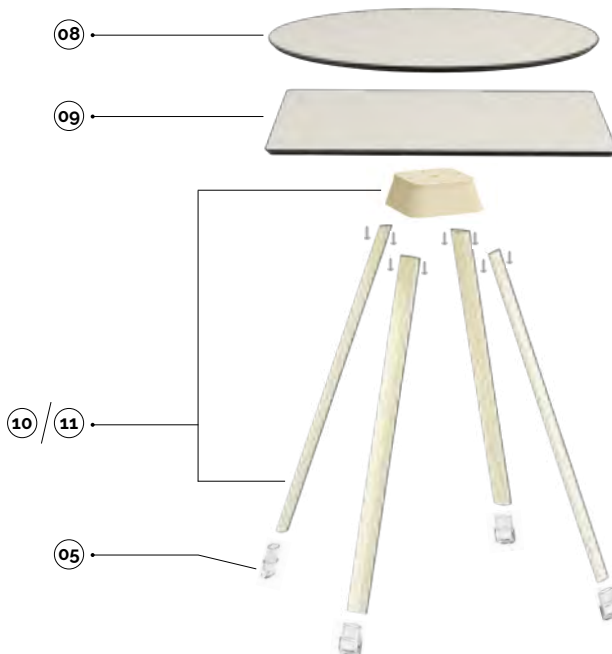

On recommande les suivantes mesures des plateaux:
Se recomiendan las siguientes medidas de tableros:

- low table 690/ 790 mm

plastic colours

- ivoire/marfil ral1013
- noir/negro ral9005

Corten ● *Une caractéristique spécifique du Corten est la variabilité dans la tonalité de la finition.
* Una característica particular del Corten es las variabilidad en la tonalidad del acabado.

main component sizes

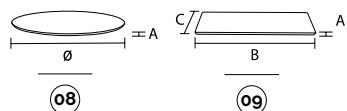
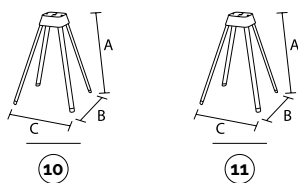

10 tapas-kit piètements table moyenne avec vis + support ivoire r1013 tapas-kit patas mesa baja con tornillos + soporte marfil r1013

code	finishing	q.kit	q.pack	a	b	c	kg.x1	vol.x1
110303-240	● noir/negro	x1	2	730	530	530	5.11	mc. 0.01155
110304-240	● gris/gris ig2621	x1	2	730	530	530	5.11	mc. 0.01155
110305-240	● ivoire/marfil ral 1013	x1	2	730	530	530	5.11	mc. 0.01155
110307-240	● corten*	x1	2	730	530	530	5.11	mc. 0.01155
110310-240	● chromé/cromado	x1	2	730	530	530	5.11	mc. 0.01155
110303-242	● noir/negro *pour extérieur/para exterior	x1	2	730	530	530	5.11	mc. 0.01155
110304-242	● gris/gris ig2621 *pour extérieur/para exterior	x1	2	730	530	530	5.11	mc. 0.01155
110305-242	● ivoire/marfil ral 1013 *pour extérieur/para exterior	x1	2	730	530	530	5.11	mc. 0.01155
110307-242	● corten* *pour extérieur/para exterior	x1	2	730	530	530	5.11	mc. 0.01155

11 tapas-kit piètements table moyenne avec vis + support noir tapas-kit patas mesa baja con tornillos + soporte negro

code	finishing	q.kit	q.pack	a	b	c	kg.x1	vol.x1
110303-241	● noir/negro	x1	2	730	530	530	5.11	mc. 0.01155
110304-241	● gris/gris ig2621	x1	2	730	530	530	5.11	mc. 0.01155
110305-241	● ivoire/marfil ral 1013	x1	2	730	530	530	5.11	mc. 0.01155
110307-241	● corten*	x1	2	730	530	530	5.11	mc. 0.01155
110310-241	● chromé/cromado	x1	2	730	530	530	5.11	mc. 0.01155
110303-243	● noir/negro *pour extérieur/para exterior	x1	2	730	530	530	5.11	mc. 0.01155
110304-243	● gris/gris ig2621 *pour extérieur/para exterior	x1	2	730	530	530	5.11	mc. 0.01155
110305-243	● ivoire/marfil ral 1013 *pour extérieur/para exterior	x1	2	730	530	530	5.11	mc. 0.01155
110307-243	● corten* *pour extérieur/para exterior	x1	2	730	530	530	5.11	mc. 0.01155

08 tapas-plateau rond + vis tapas-sobre redondo + tornillos

code	finishing	q.kit	q.pack	a	ø	kg.x1	vol.x1
120303-021	● noir/negro	x1	5	10	590	4.8	mc. 0.0072
120303-022	● noir/negro	x1	5	10	690	6.6	mc. 0.0098
120303-023	● noir/negro	x1	5	10	790	8.4	mc. 0.0128
120305-021	● ivoire/marfil ral 1013	x1	5	10	590	4.8	mc. 0.0072
120305-022	● ivoire/marfil ral 1013	x1	5	10	690	6.6	mc. 0.0098
120305-023	● ivoire/marfil ral 1013	x1	5	10	790	8.4	mc. 0.0128

09 tapas-plateau carré + vis tapas-sobre cuadrado + tornillos

code	finishing	q.kit	q.pack	a	b	c	kg.x1	vol.x1
120303-024	● noir/negro	x1	5	10	590	590	6.0	mc. 0.0072
120303-025	● noir/negro	x1	5	10	690	690	8.2	mc. 0.0098
120303-026	● noir/negro	x1	5	10	790	790	10.7	mc. 0.0128
120305-024	● ivoire/marfil ral 1013	x1	5	10	590	590	6.0	mc. 0.0072
120305-025	● ivoire/marfil ral 1013	x1	5	10	690	690	8.2	mc. 0.0098
120305-026	● ivoire/marfil ral 1013	x1	5	10	790	790	10.7	mc. 0.0128

05 tapas-pied elliptique 40x20 h30 tapas-tapón elíptico 40x20 h30

code	finishing	q.kit	kg.x1
134303-045	● noir/negro	x4	0.0174 mc. 0.00003
134306-005	○ transparent/transparente	x4	0.0174 mc. 0.00003

tapas

coffee table

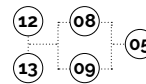
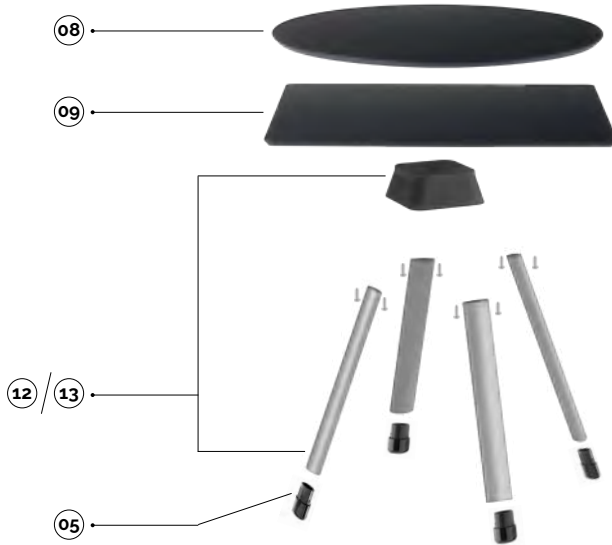

On recommande les suivantes
mesures des plateaux:
Se recomiendan las siguientes
medidas de tableros:

- coffee table 590 mm

plastic colours

- ivoire/marfil ral1013
- noir/negro ral9005

Corten ● *Une caractéristique spécifique du Corten est la variabilité dans la tonalité de la finition.
* Una característica particular del Corten es la variabilidad en la tonalidad del acabado.

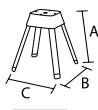
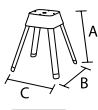

12

13

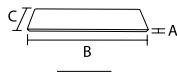
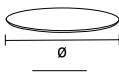

08

09

main component sizes

12 tapas-kit piètements table basse avec vis + support ivoire r1013 tapas-kit patas mesita de café con tornillos + soporte marfil r1013

code	finishing	q.kit	q.pack	a	b	c	kg.x1	vol.x1
110303-248	● noir/negro	x1	2	390	353	353	2,92	mc. 0.006405
110304-248	● gris/gris ig2621	x1	2	390	353	353	2,92	mc. 0.006405
110305-248	● ivoire/marfil ral 1013	x1	2	390	353	353	2,92	mc. 0.006405
110307-248	● corten*	x1	2	390	353	353	2,92	mc. 0.006405
110310-248	● chromé/cromado	x1	2	390	353	353	2,92	mc. 0.006405
110303-250	● noir/negro *pour extérieur/para exterior	x1	2	390	353	353	2,92	mc. 0.006405
110304-250	● gris/gris ig2621 *pour extérieur/para exterior	x1	2	390	353	353	2,92	mc. 0.006405
110305-250	● ivoire/marfil ral 1013 *pour extérieur/para exterior	x1	2	390	353	353	2,92	mc. 0.006405
110307-250	● corten* *pour extérieur/para exterior	x1	2	390	353	353	2,92	mc. 0.006405

13 tapas-kit piètements table basse avec vis + support noir tapas-kit patas mesita de café con tornillos + soporte negro

code	finishing	q.kit	q.pack	a	b	c	kg.x1	vol.x1
110303-249	● noir/negro	x1	2	390	353	353	2,92	mc. 0.006405
110304-249	● gris/gris ig2621	x1	2	390	353	353	2,92	mc. 0.006405
110305-249	● ivoire/marfil ral 1013	x1	2	390	353	353	2,92	mc. 0.006405
110307-249	● corten*	x1	2	390	353	353	2,92	mc. 0.006405
110310-249	● chromé/cromado	x1	2	390	353	353	2,92	mc. 0.006405
110303-251	● noir/negro *pour extérieur/para exterior	x1	2	390	353	353	2,92	mc. 0.006405
110304-251	● gris/gris ig2621 *pour extérieur/para exterior	x1	2	390	353	353	2,92	mc. 0.006405
110305-251	● ivoire/marfil ral1013 *pour extérieur/para exterior	x1	2	390	353	353	2,92	mc. 0.006405
110307-251	● corten* *pour extérieur/para exterior	x1	2	390	353	353	2,92	mc. 0.006405

08 tapas-plateau rond + vis tapas-sobre redondo + tornillos

code	finishing	q.kit	q.pack	a	Ø	kg.x1	vol.x1
120303-021	● noir/negro	x1	5	10	590	4,8	mc. 0.0072
120303-022	● noir/negro	x1	5	10	690	6,6	mc. 0.0098
120303-023	● noir/negro	x1	5	10	790	8,4	mc. 0.0128
120305-021	● ivoire/marfil ral 1013	x1	5	10	590	4,8	mc. 0.0072
120305-022	● ivoire/marfil ral 1013	x1	5	10	690	6,6	mc. 0.0098
120305-023	● ivoire/marfil ral 1013	x1	5	10	790	8,4	mc. 0.0128

09 tapas-plateau carré + vis tapas-sobre cuadrado + tornillos

code	finishing	q.kit	q.pack	a	b	c	kg.x1	vol.x1
120303-024	● noir/negro	x1	5	10	590	590	6,0	mc. 0.0072
120303-025	● noir/negro	x1	5	10	690	690	8,2	mc. 0.0098
120303-026	● noir/negro	x1	5	10	790	790	10,7	mc. 0.0128
120305-024	● ivoire/marfil ral 1013	x1	5	10	590	590	6,0	mc. 0.0072
120305-025	● ivoire/marfil ral 1013	x1	5	10	690	690	8,2	mc. 0.0098
120305-026	● ivoire/marfil ral 1013	x1	5	10	790	790	10,7	mc. 0.0128

05 tapas-pied elliptique 40x20 h30 tapas-tapón elíptico 40x20 h30

code	finishing	q.kit	kg.x1
134303-045	● noir/negro	x4	0.0174 mc. 0.00003
134306-005	○ transparent/transparente	x4	0.0174 mc. 0.00003



tapas

4-legs/metal shell



14 15 16

Corten ● *Une caractéristique spécifique du Corten est la variabilité dans la tonalité de la finition.
 * Una característica particular del Corten es las variabilidad en la tonalidad del acabado.

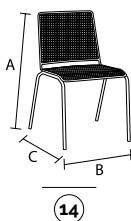

main component sizes

14 châssis 4 pieds avec coque en maillage
 estructura 4 patas con carcasa de malla

code	finishing		q.kit	q.pack	a	b	c	kg.x1	vol.x1
110105-367	● ivoire/marfil	ral.1013 *pour extérieur/para exterior	x1	1	805	535	580	5,6	mc. 0.024
110107-367	● corten*	*pour extérieur/para exterior	x1	1	805	535	580	5,6	mc. 0.024

15 pack embouts sphérique d.18 noirs
 paquete de tapón esférico d.18 negros

code	finishing	q.kit
134203-181	● noir/negro	x4

16 pare-chocs tête plate 12x3,8x6x9 neutre
 protectores cabeza llana 12x3,8x6x9 neutra

code	finishing	q.kit
134006-102	○ neutre/neutro	x4

tapas

stool/metal shell



17 15 16

Corten • *Une caractéristique spécifique du Corten est la variabilité dans la tonalité de la finition.
 * Una característica particular del Corten es la variabilidad en la tonalidad del acabado.

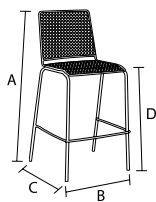

17

main component sizes

17 tabouret h750 avec coque en maillage
 taburete h750 con carcasa de malla

code	finishing		q.kit	q.pack	a	b	c	d	kg.x1	vol.x1
110105-374	ivoire/marfil	ral.1013 *pour extérieur/para exterior	x1	1	1100	540	540	750	7,8	mc. 0,048
110107-374	corten*	*pour extérieur/para exterior	x1	1	1100	540	540	750	7,8	mc. 0,048

15 pack embouts sphérique d.18 noirs
 paquete de tapón esférico d.18 negros

code	finishing	q.kit
134203-181	noir/negro	x4

16 pare-chocs tête plate 12x3,8x6x9 neutre
 protectores cabeza llana 12x3,8x6x9 neutra

code	finishing	q.kit
134006-102	neutre/neutro	x4

tapas

slide/metal shell



18 19

Corten • *Une caractéristique spécifique du Corten est la variabilité dans la tonalité de la finition.
 * Una característica particular del Corten es las variabilidad en la tonalidad del acabado.

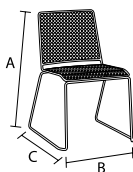

18

main component sizes

18 châssis coulissant tige d. 12 avec coque en mailage
 estructura patin de varilla d. 12 con carcasa de malla

code	finishing		q.kit	q.pack	a	b	c	kg.x1	vol.x1
110505-504	● ivoire/marfil	ral.1013 *pour extérieur/para exterior	x1	1	805	520	595	7.7	mc. 0.036
110507-504	● corten*	*pour extérieur/para exterior	x1	1	805	520	595	7.7	mc. 0.036

19 pack de bases a pince anti-rotation pour tige couleur neutre
 paquete de bases con pinza antirotacion para varilla de color neutro

code	finishing	q.kit	q.pack
137006-070	○ neutre/neutro	x4	200





spot



discover more about
Spot Collection

Un pied pliant pratique et innovant. Sans structure centrale, le pied Spot proposé sous forme de trois largeurs assure la réalisation de tables pliables dans de nombreuses dimensions.

Spot est un pied idéal pour tout type de salles de conférence et de restauration.

Una pata plegable, práctica e innovadora. La pata Spot sin estructura central, en sus tres anchuras garantiza la realización de mesas plegables de varias dimensiones.

Spot es la pata ideal para todos los ambientes de congresos y catering.

Plus

- Il est asymétrique et s'adapte parfaitement à toutes les dimensions de top.
- Il est pliable et assure par conséquent un gerbage total des tables.
- Il est muni de supports réglables pour que la table puisse facilement s'adapter n'importe où dans une salle.
- Certification EN 1730:2012 de Niveau 2.
- Système de pliage breveté.
- *Es asimétrica y se adapta perfectamente a todas las dimensiones del sobre.*
- *Es plegable, por lo que garantiza la apilabilidad completa de las mesas.*
- *Presenta tacos regulables, para que sea fácil adaptar la mesa en todos los puntos de una sala.*
- *Certificación EN 1730:2012 Nivel 2.*
- *Sistema plegable patentado.*



designed by:
Esedra



**certified
product**



**patented
product**

spot

components

PATENTED
and CERTIFIED

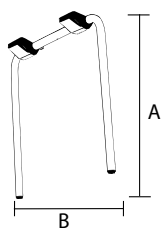

spot-pied repliable d.35 h.700 pour plateau 800 avec accessoires-boîtes de deux pièces
spot-pata plegable d.35 h.700 para sobre de 800 con accesorios-caja de dos unidades

code	finishing	q.kit	q.pack	a	b	kg.x1	vol.x1
110304-014	● gris/gris	x2	2	715	750	4,80	mc. 0.03
110305-014	○ blanc/blanco	x2	2	715	750	4,80	mc. 0.03
110310-090	● chromé/cromado	x2	2	715	750	4,80	mc. 0.03

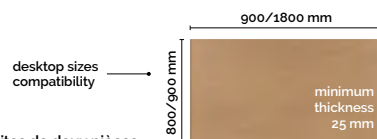

main component sizes

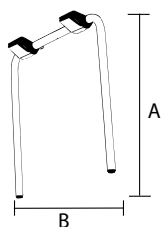

spot-pied repliable ø35 h.700 pour plateau 700 avec accessoires-boîtes de deux pièces
spot-pata plegable d.35 h.700 para sobre de 700 con accesorios-caja de dos unidades

code	finishing	q.kit	q.pack	a	b	kg.x1	vol.x1
110304-038	● gris/gris	x2	2	715	650	4,64	mc. 0.03
110305-013	○ blanc/blanco	x2	2	715	650	4,64	mc. 0.03
110310-093	● chromé/cromado	x2	2	715	650	4,64	mc. 0.03

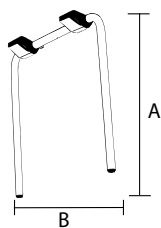
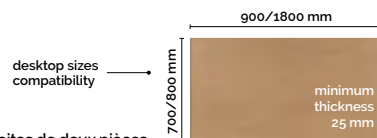

spot-pied repliable ø35 h.700 pour plateau 600 avec accessoires-boîtes de deux pièces
spot-pata plegable d.35 h.700 para sobre de 600 con accesorios-caja de dos unidades

code	finishing	q.kit	q.pack	a	b	kg.x1	vol.x1
110304-039	● gris/gris	x2	2	715	550	4,48	mc. 0.03
110305-039	○ blanc/blanco	x2	2	715	550	4,48	mc. 0.03
110310-096	● chromé/cromado	x2	2	715	550	4,48	mc. 0.03

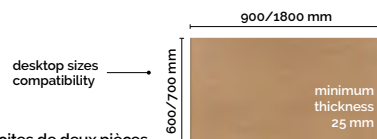

spot-attaches pour raccorder plateaux de tables en plastique + vis
spot-pareja enganches para unión sobres mesas de plástico + tornillo

code	finishing	q.kit	q.pack	kg.x1
134003-223	● noir/negro	x2	20	0,005



spot-chariot porte-tables avec accessoires
spot-carro para mesas con accesorios

code	finishing	kg.x1
110803-028	● noir/negro	
110804-028	● gris/gris	

spot

components

6 simple movements



focus on: new table joining hook

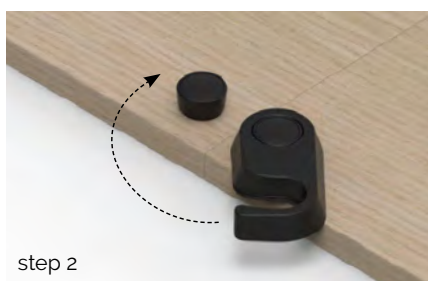
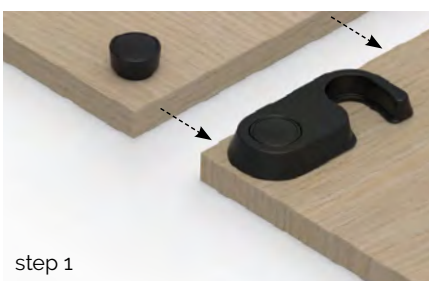



unyo



discover more about
Unyo Collection

La collection Unyo offre une large et complète gamme de canapés comprenant des versions indépendantes et modulaires. Cette dernière version dispose d'un système d'assemblage modulaire breveté basé sur des joints en plastique pratiques et faciles à installer. Caractérisée par un design linéaire et rigoureux, la collection se distingue comme un meuble élégant et polyvalent pouvant s'adapter aux contextes d'utilisation les plus divers.

Les modules et les coussins en polyuréthane sont livrés non finis, à recouvrir.

La colección Unyo ofrece una amplia y completa gama de sofás compuesta por versiones independientes y modulares. Esta última versión cuenta con un sistema patentado de unión modular basado en juntas de plástico prácticas y fáciles de instalar. Caracterizada por un diseño lineal y riguroso, la colección destaca por ser un mueble elegante y versátil, capaz de adaptarse a los más diversos contextos de uso.

Los módulos y almohadas de poliuretano se suministran en bruto, para tapizar.

Plus

- Versions indépendantes et modulaires.
- Système d'assemblage modulaire breveté.
- Modules en polyuréthane sans structure métallique interne.
- Polyuréthane classe IM.
- Versiones autónomas y modulares.
- Sistema de unión modular patentado.
- Módulos de poliuretano sin estructura metálica interna.
- Poliuretano clase IM.



designed by:
R&D Alba



**patented
product**

unyo

armchair

single frame version

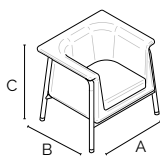

01

01 unyo.fauteuil - châssis soudé + pieds + vis + polyuréthane + coussin + panneaux de bois
 unyo.sillón - estructura soldada + pies + tornillos + poliuretano + almohada + paneles de madera

code	finishing		a	b	c
111605-095	○ blanc/blanco	ral 9010	824	697	751
111603-095	● noir/negro	ral 9005	824	697	751
111610-095	● chromé/cromado		824	697	751
111605-094	● beige/beige	ral 1019	824	697	751

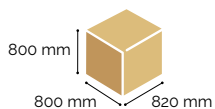
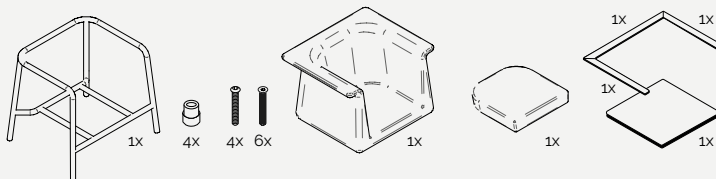

unyo

sofa 2 seater

single frame version

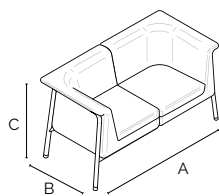

02

02 unyo.canapé 2 places - châssis soudé + pieds + vis + polyuréthanes + coussins + panneaux de bois
 unyo.sofá 2 plazas - estructura soldada + pies + tornillos + poliuretanos + almohada + paneles de madera

code	finishing		a	b	c
111605-096	○ blanc/blanco	ral 9010	1424	700	751
111603-096	● noir/negro	ral 9005	1424	700	751
111610-096	● chromé/cromado		1424	700	751
111605-097	● beige/beige	ral 1019	1424	700	751

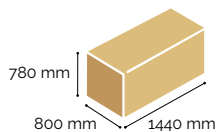
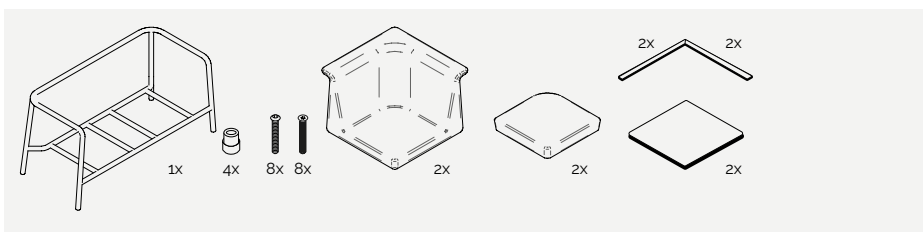

unyo

bench

single frame version

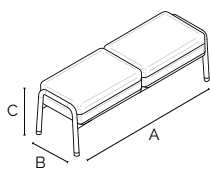

03

03 unyo.banc 2 places - châssis soudé + pieds + vis + coussins + panneaux de bois
 unyo.banco 2 plazas - estructura soldada + pies + tornillos + almohada + paneles de madera

code	finishing		a	b	c
111605-111	○ blanc/blanco	ral 9010	1370	430	440
111603-111	● noir/negro	ral 9005	1370	430	440
111610-111	● chromé/cromado		1370	430	440
111605-112	● beige/beige	ral 1019	1370	430	440

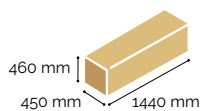
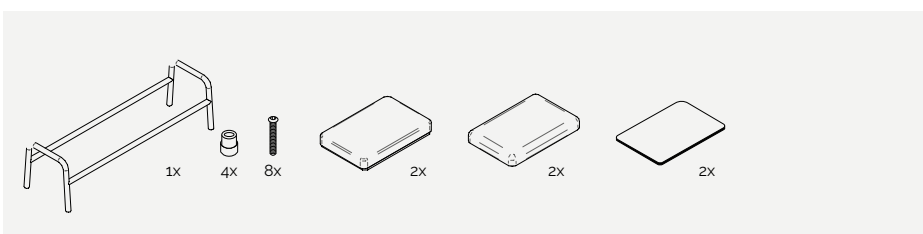

unyo

right corner module

modular version

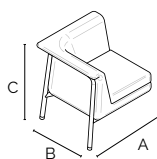

04

04 unyo.module d'angle droit - kit châssis + pieds + vis + polyuréthane + coussin + panneaux de bois
 unyo.módulo angular derecho - kit estructura + pies + tornillos + poliuretano + almohada + paneles de madera

code	finishing		a	b	c
111605-102	○ blanc/blanco	ral 9010	712	700	751
111603-102	● noir/negro	ral 9005	712	700	751
111610-102	● chromé/cromado		712	700	751
111605-101	● beige/beige	ral 1019	712	700	751

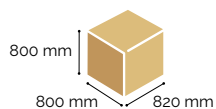
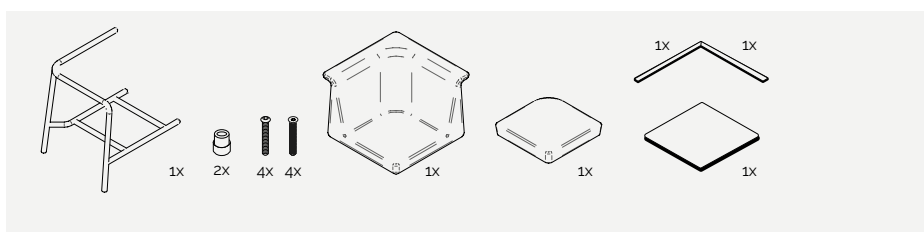

unyo

left corner module

modular version



05

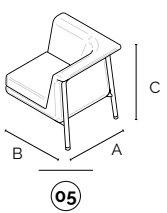

05 unyo.module d'angle gauche - kit châssis + pieds + vis + polyuréthane + coussin + panneaux de bois
 unyo.módulo angular izquierdo - kit estructura + pies + tornillos + poliuretano + almohada + paneles de madera

code	finishing		a	b	c
111605-103	○ blanc/blanco	ral 9010	700	712	751
111603-103	● noir/negro	ral 9005	700	712	751
111610-103	● chromé/cromado		700	712	751
111605-104	● beige/beige	ral 1019	700	712	751

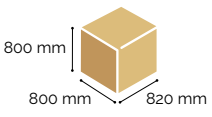
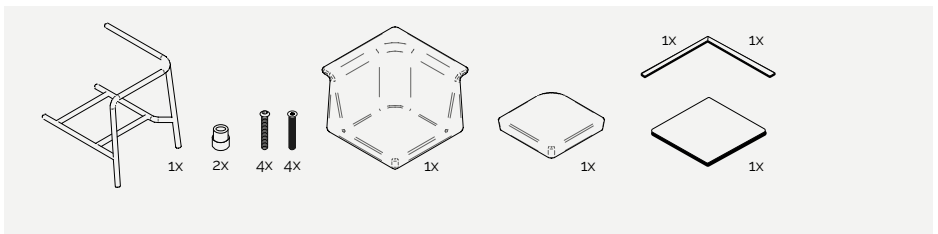

unyo

central module

modular version

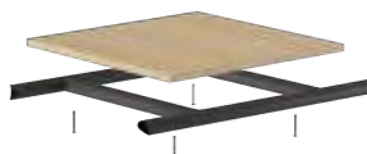

06

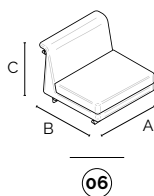

06 unyo.module central - kit châssis + vis + polyuréthane + coussin + panneaux de bois
 unyo.módulo central - kit estructura + tornillos + poliuretano + almohada + paneles de madera

code	finishing		a	b	c
111605-105	○ blanc/blanco	ral 9010	700	700	525
111603-105	● noir/negro	ral 9005	700	700	525
111610-105	● chromé/cromado		700	700	525
111605-106	● beige/beige	ral 1019	700	700	525

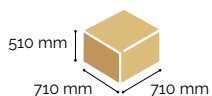
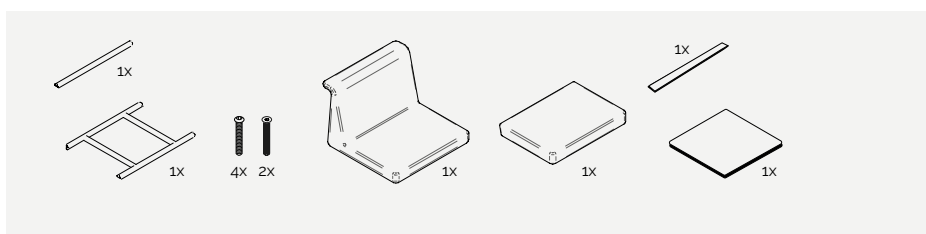

unyo

open curved module

modular version

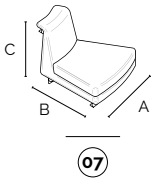

07 unyo.module courbe ouvert - kit châssis + vis + polyuréthane + coussin + panneaux de bois
 unyo.módulo curvo abierto - kit estructura + tornillos + poliuretano + almohada + paneles de madera

code	finishing		a	b	c
111605-107	○ blanc/blanco	ral 9010	659	714	525
111603-107	● noir/negro	ral 9005	659	714	525
111610-107	● chromé/cromado		659	714	525
111605-108	● beige/beige	ral 1019	659	714	525

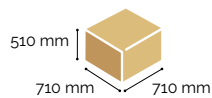
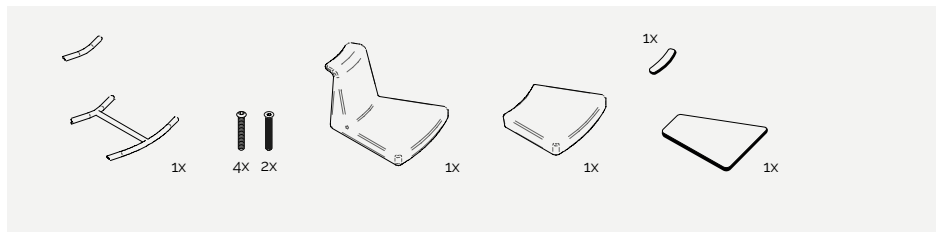

unyo

closed curved module

modular version

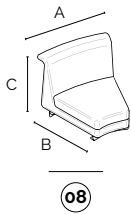
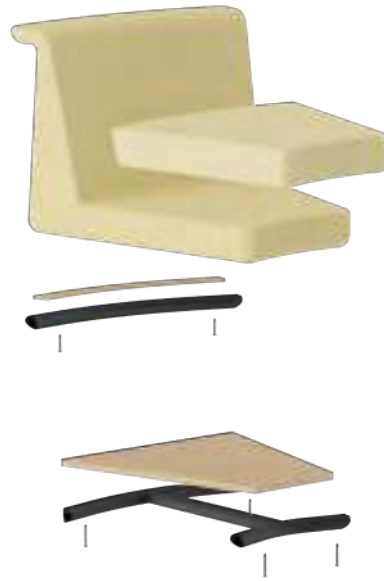

08 unyo.module courbe fermé - kit châssis + vis + polyuréthane + coussin + panneaux de bois
 unyo.módulo curvo cerrado - kit estructura + tornillos + poliuretano + almohada + paneles de madera

code	finishing		a	b	c
111605-109	○ blanc/blanco	ral 9010	659	714	525
111603-109	● noir/negro	ral 9005	659	714	525
111610-109	● chromé/cromado		659	714	525
111605-110	● beige/beige	ral 1019	659	714	525

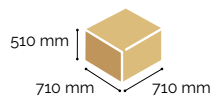
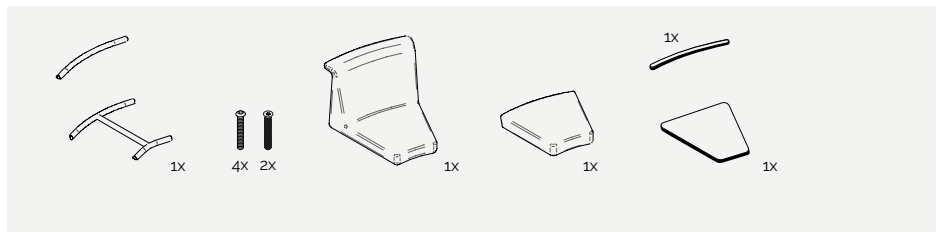

unyo

restart module

modular version

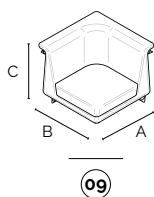
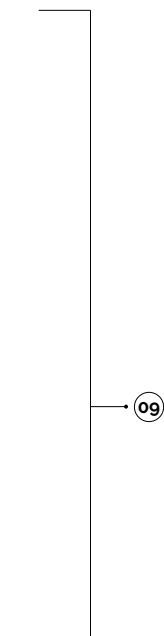

09 unyo.module de départ - châssis soudé + pied + vis + polyuréthane + coussins + panneaux de bois
 unyo.módulo de arranque - estructura soldada + pie + tornillos + poliuretano + almohada + paneles de madera

code	finishing		a	b	c
111605-098	○ blanc/blanco	ral 9010	700	700	751
111603-098	● noir/negro	ral 9005	700	700	751
111610-098	● chromé/cromado		700	700	751
111605-099	● beige/beige	ral 1019	700	700	751

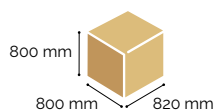
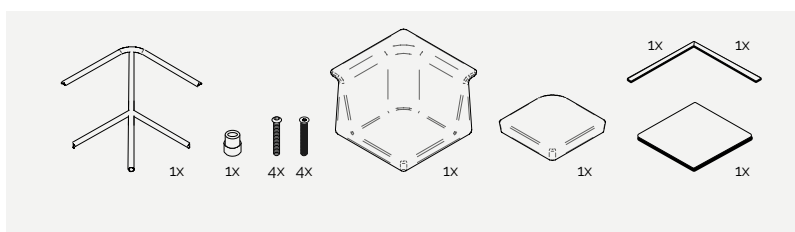

unyo

central legs

modular version

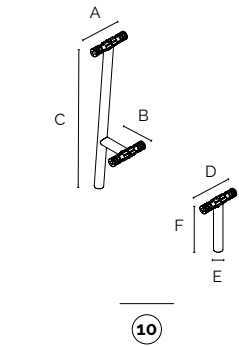
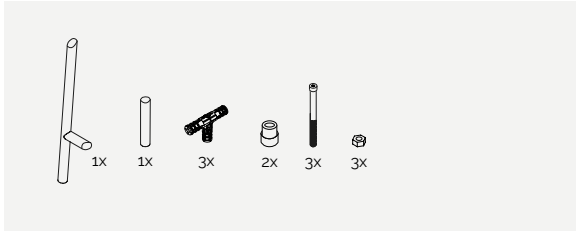

10 unyo.pieds centraux - kit pieds avec joints + pieds + vis
unyo.patas centrales - kit patas con juntas + pies + tornillos

code	finishing		a	b	c	d	e	f
111605-090	○ blanc/blanco	ral 9010	160	164	709	160	35	260
111603-090	● noir/negro	ral 9005	160	164	709	160	35	260
111610-090	● chromé/cromado		160	164	709	160	35	260
111605-091	● beige/beige	ral 1019	160	164	709	160	35	260

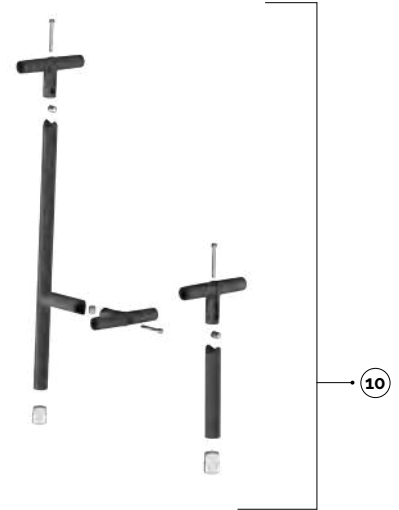
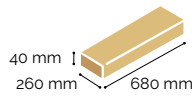

unyo

corner legs

modular version

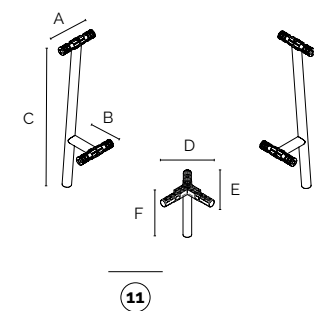

11 unyo.pieds d'angle - kit pieds avec joints + pieds + vis
unyo.patas angulaires - kit patas con juntas + pies + tornillos

code	finishing		a	b	c	d	e	f
111605-092	○ blanc/blanco	ral 9010	160	164	709	215	222	265
111603-092	● noir/negro	ral 9005	160	164	709	215	222	265
111610-092	● chromé/cromado		160	164	709	215	222	265
111605-093	● beige/beige	ral 1019	160	164	709	215	222	265

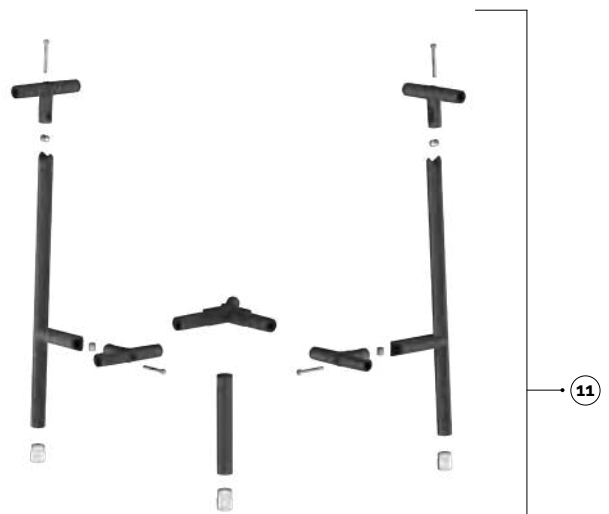
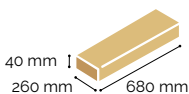



modula



discover more about
Modula Collection

Modula combine le concept de bibliothèque le plus classique avec la polyvalence d'utilisation d'une unité d'étagères modulaire moderne, résultant en un système de mobilier polyvalent et pratique.

Grâce à ses caractéristiques modulaires, la collection Modula peut s'adapter à différents besoins d'aménagement, tant dans des environnements professionnels et commerciaux que dans des environnements domestiques.

Modula combina el concepto más clásico de librería con la versatilidad de uso de una moderna estantería modular, formando un sistema de mobiliario versátil y práctico.

Gracias a sus características modulares, la colección Modula puede adaptarse a diferentes necesidades de mobiliario, tanto en contextos profesionales y comerciales, como en entornos domésticos.

Plus

- Convient pour un montage au plafond ou au mur.
- Système de support d'étagère breveté.
- Certification EN16122:2021 + AC:2015.
- Grande polyvalence modulaire.
- Montants en aluminium.
- *Apta para instalación en techo o pared.*
- *Sistema patentado de soporte de estantes.*
- *Certificación EN16122:2021 + AC:2015.*
- *Gran versatilidad modular.*
- *Montantes de aluminio.*



designed by:
R&D Alba



**patented
product**



**certified
product**

modula

single column

wall version

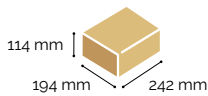

03

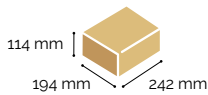

04

2 kit supporti mensola x imballo
2 shelf support kits x packaging

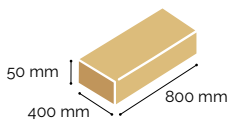

05 07

2 mensole x imballo
2 shelves x packaging

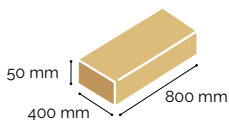

06 08

4 mensole x imballo
4 shelves x packaging



21 outil multifonction
herramienta multifunción

code finishing
110803-415 ● galvanisé/galvanizado

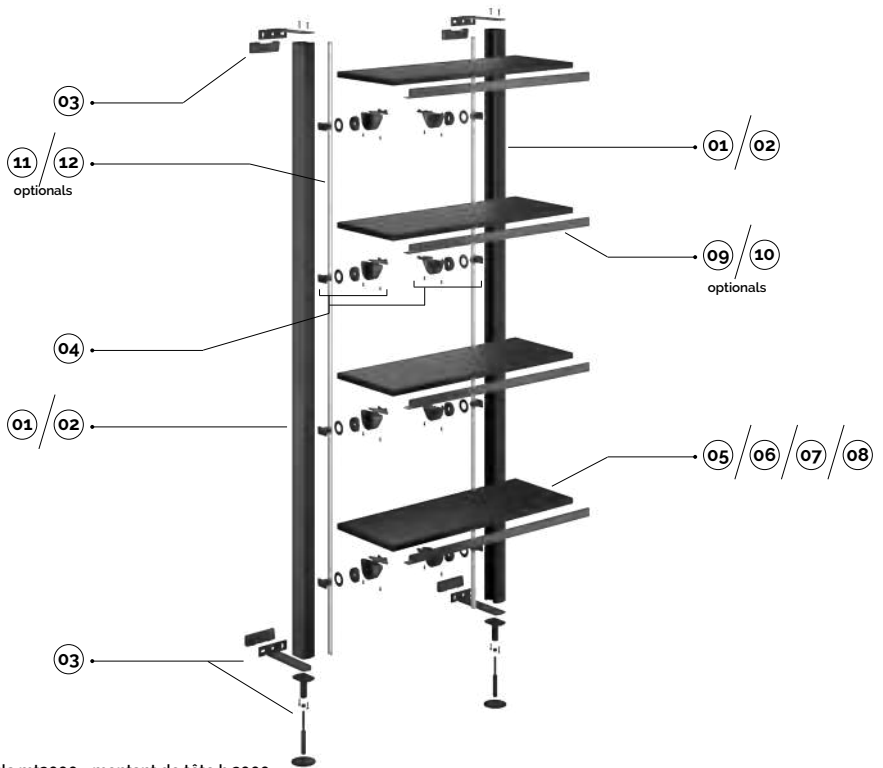

01 modula.mt2000 - montant de tête h.2000
modula.mt2000 - mástil por cabeza h.2000

code	finishing		a	b	c
110805-402	○ blanc/blanco	ral 9010	71	51	2000
110803-402	● noir/negro	ral 9005	71	51	2000

02 modula.mt1000 - montant de tête h.1000
modula.mt1000 - mástil por cabeza h.1000

code	finishing		a	b	c
110805-403	○ blanc/blanco	ral 9010	71	51	1000
110803-403	● noir/negro	ral 9005	71	51	1000

03 modula.fp. - kit accessoires pour mur
modula.fp. - kit para pared accesorios

code	finishing				
110805-419	○ blanc/blanco	ral 9010			
110803-419	● noir/negro	ral 9005			

04 modula.supm. - kit supports étagère
modula.supm. - kit soportes estante

code	finishing				
110805-423	○ blanc/blanco	ral 9010			
110803-423	● noir/negro	ral 9005			

05 modula.mensl. - kit étagère mélaminé 790x300 + vis
modula.mensl. - kit estante melaminado 790x300 + tornillos

code	finishing		a	b	c
110805-424	○ blanc/blanco		790	300	20
110803-424	● noir/negro		790	300	20

06 modula.mensl. - kit étagère mélaminé 368,5x300 + vis
modula.mensl. - kit estante melaminado 368,5x300 + tornillos

code	finishing		a	b	c
110805-425	○ blanc/blanco		368,5	300	20
110803-425	● noir/negro		368,5	300	20

07 modula.mensm. - kit étagère métal 790x300 + vis
modula.mensm. - kit estante metálico 790x300 + tornillos

code	finishing		a	b	c	d
110805-426	○ blanc/blanco	ral 9010	790	300	17,5	30
110803-426	● noir/negro	ral 9005	790	300	17,5	30

08 modula.mensm. - kit étagère métal 368,5x300 + vis
modula.mensm. - kit estante metálico 368,5x300 + tornillos

code	finishing		a	b	c	d
110805-427	○ blanc/blanco	ral 9010	368,5	300	17,5	30
110803-427	● noir/negro	ral 9005	368,5	300	17,5	30

09 modula.l79 - profilé en aluminium pour étagères en bois L790 mm + vis
modula.l79 - perfil de aluminio para estantes de madera L790 mm + tornillos

code	finishing		a	b	c
110805-032	○ blanc/blanco	ral 9010	790	30	30
110803-032	● noir/negro	ral 9005	790	30	30
110804-032	● aluminium anodisé/aluminio anodizado		790	30	30

10 modula.l37 - profilé en aluminium pour étagères en bois L368,5 mm + vis
modula.l37 - perfil de aluminio para estantes de madera L368,5 mm + tornillos

code	finishing		a	b	c
110805-031	○ blanc/blanco	ral 9010	368,5	30	30
110803-031	● noir/negro	ral 9005	368,5	30	30
110804-031	● aluminium anodisé/aluminio anodizado		368,5	30	30

11 modula.o2000 - profilé opalin pour couverture h.2000
modula.o2000 - perfil opalino para cobertura h.2000

code	finishing		a	b	c
130805-429	○ opaline/opalino		7,5	15,2	2000

12 modula.o1000 - profilé opalin pour couverture h.1000
modula.o1000 - perfil opalino para cobertura h.1000

code	finishing		a	b	c
130805-428	○ opaline/opalino		7,5	15,2	1000

modula

multiple columns
wall version

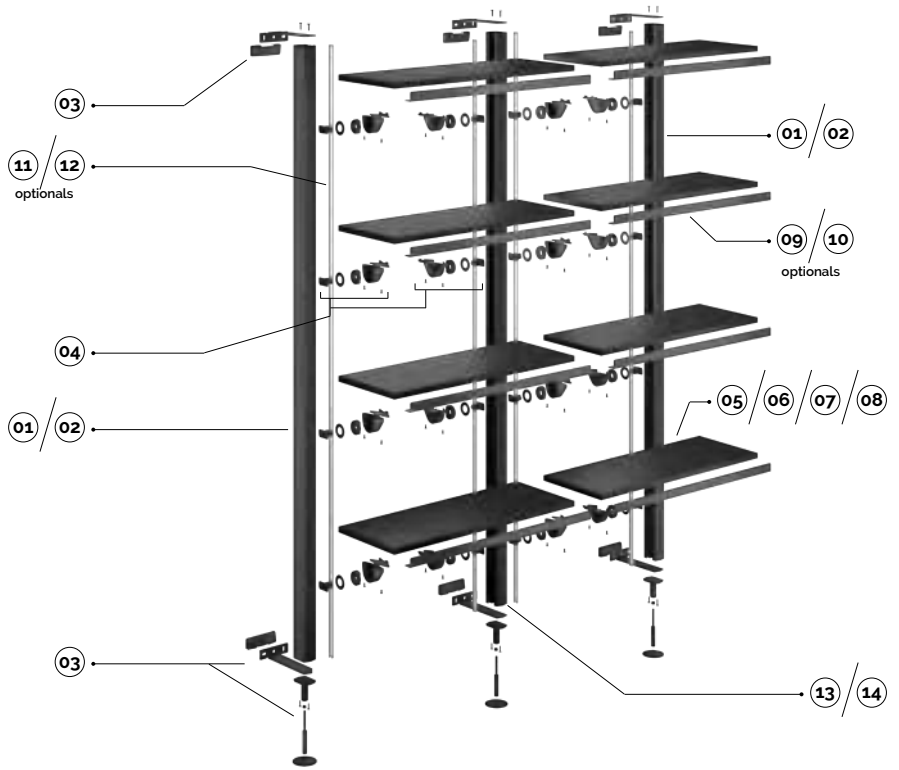

13 modula.mi2000 - montant central h.2000
modula.mi2000 - montante central h.2000

code	finishing		a	b	c
110805-405	○ blanc/blanco	ral 9010	71	51	2000
110803-405	● noir/negro	ral 9005	71	51	2000

14 modula.mi1000 - montant central h.1000
modula.mi1000 - mäsfil central h.1000

code	finishing		a	b	c
110805-406	○ blanc/blanco	ral 9010	71	51	1000
110803-406	● noir/negro	ral 9005	71	51	1000

for the components below, see previous page

- 01 02 03 04 05 06
07 08 09 10 11 12



kit
wall version

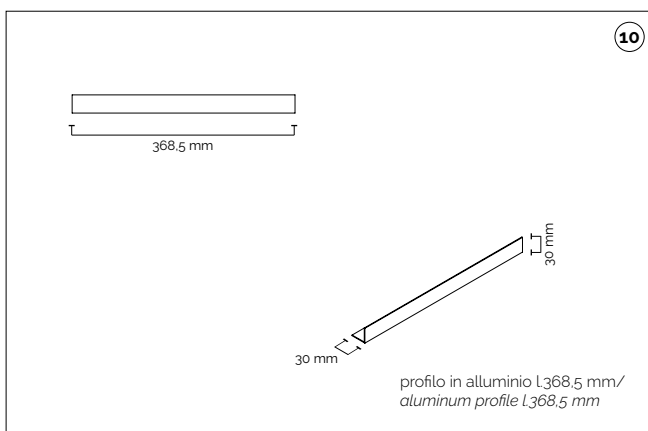
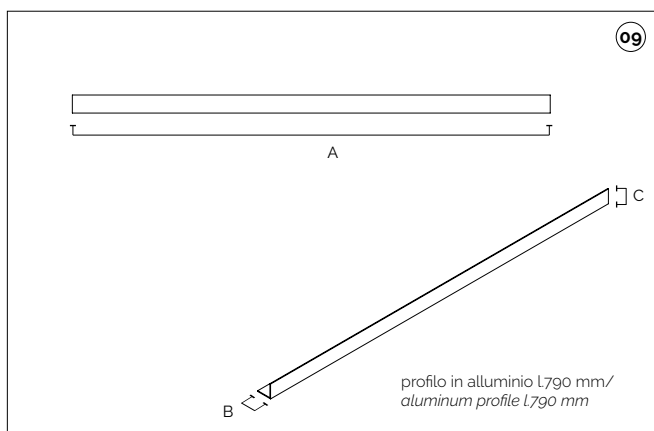
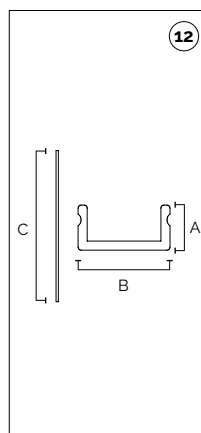
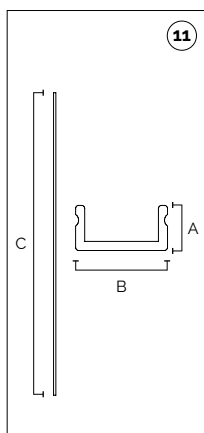
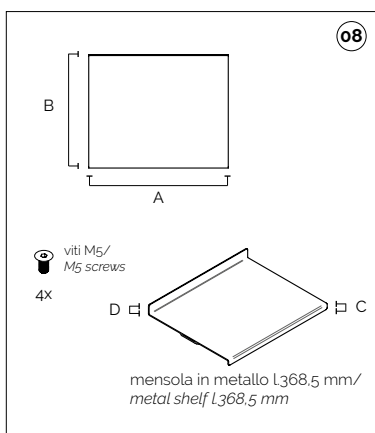
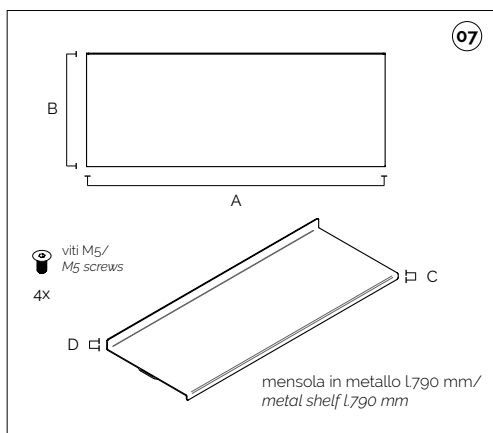
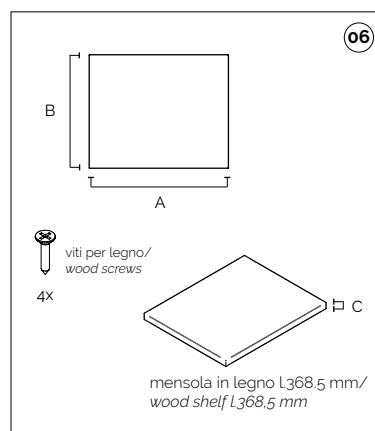
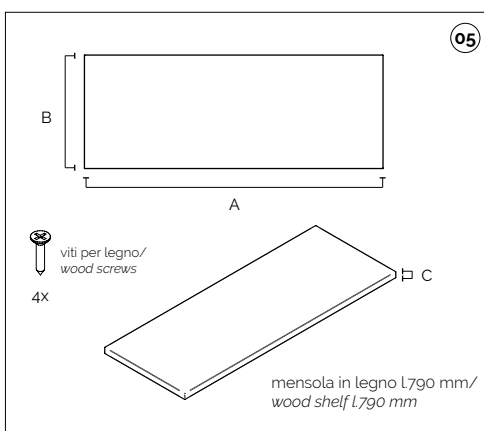
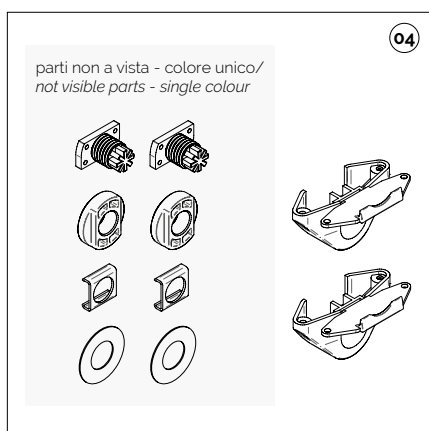
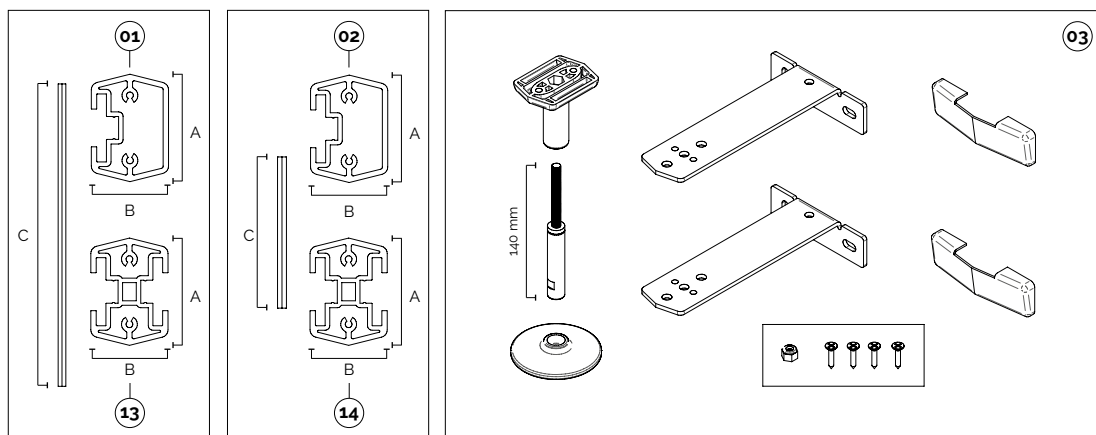



modula

single column

ceiling version

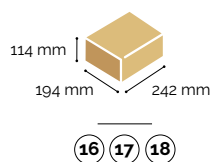
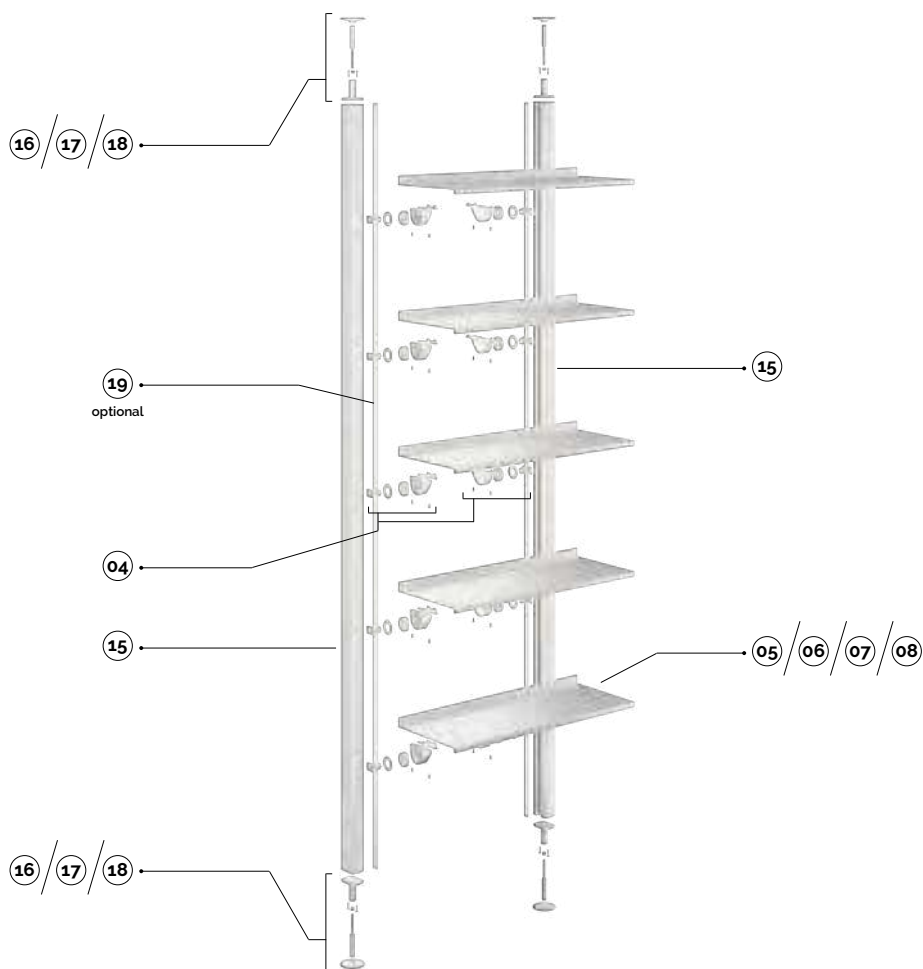

15 modula.mt2500 - montant de tête h.2500
modula.mt2500 - mástil por cabeza h.2500

code	finishing		a	b	c
110805-401	○ blanc/blanco	ral 9010	71	51	2500
110803-401	● noir/negro	ral 9005	71	51	2500

16 modula.fs1. - kit accessoires pour plafond taille 1
modula.fs1. - kit para techo tamaño 1 accesorios

code	finishing		a	ø
110805-420	○ blanc/blanco	ral 9010	142	15,3
110803-420	● noir/negro	ral 9005	142	15,3

17 modula.fs2. - kit accessoires pour plafond taille 2
modula.fs2. - kit para techo tamaño 2 accesorios

code	finishing		a	ø
110805-421	○ blanc/blanco	ral 9010	192	15,3
110803-421	● noir/negro	ral 9005	192	15,3

18 modula.fs3. - kit accessoires pour plafond taille 3
modula.fs3. - kit para techo tamaño 3 accesorios

code	finishing		a	ø
110805-422	○ blanc/blanco	ral 9010	242	15,3
110803-422	● noir/negro	ral 9005	242	15,3

19 modula.o2500 - profilé opalin pour couverture h.2500
modula.o2500 - perfil opalino para cobertura h.2500

code	finishing		a	b	c
130805-430	○ opaline/opalino		7,5	15,2	2500

for the components below, see previous pages

04 05 06 07 08

modula

multiple columns

ceiling version

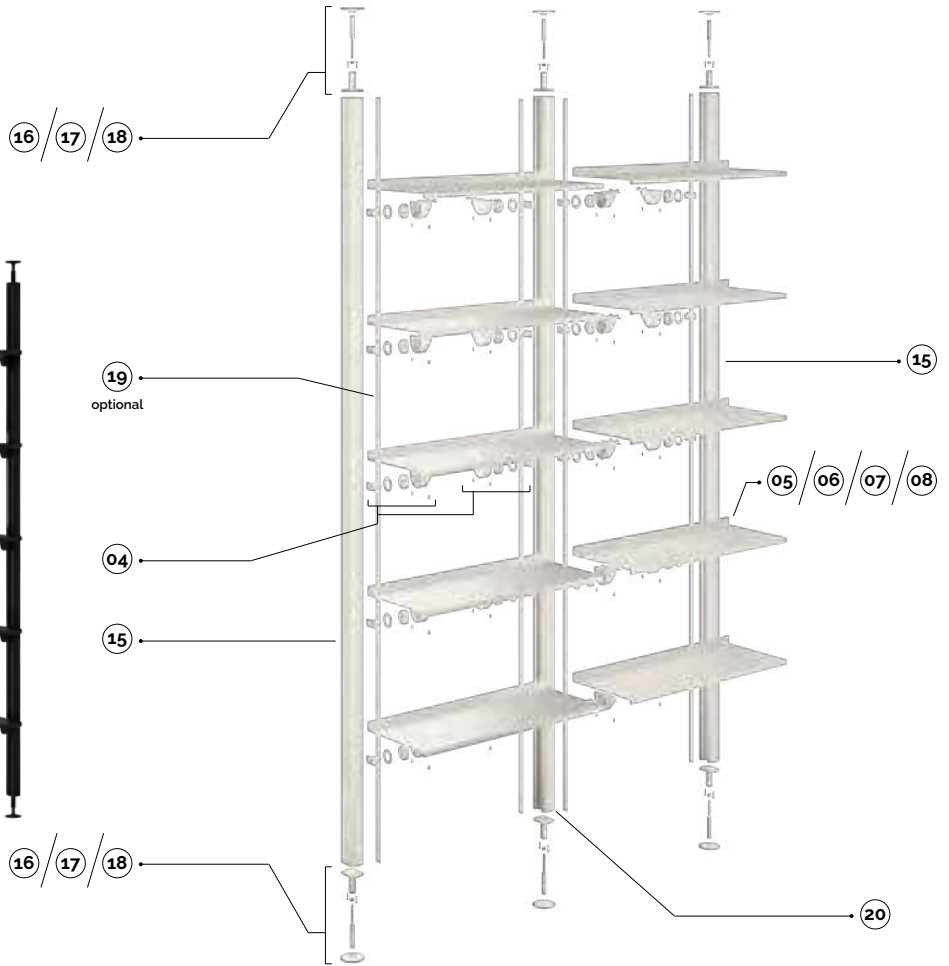
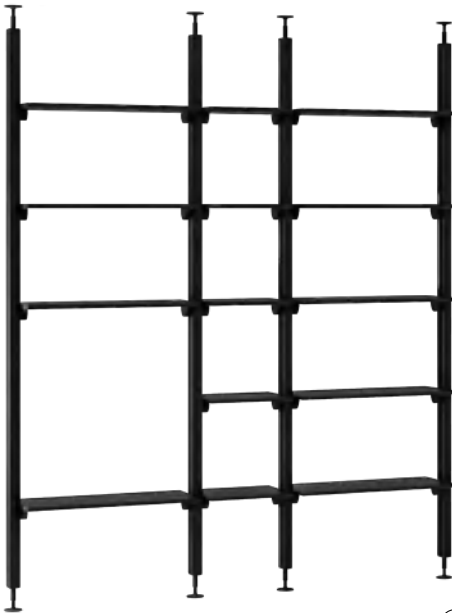

for the components below, see previous pages

15 16 17 18 19

04 05 06 07 08

20 modula.mi2500 - montant central h.2500
modula.mi2500 - mástil central h.2500

code	finishing		a	b	c
110805-404	○ blanc/blanco	ral 9010	71	51	2500
110803-404	● noir/negro	ral 9005	71	51	2500

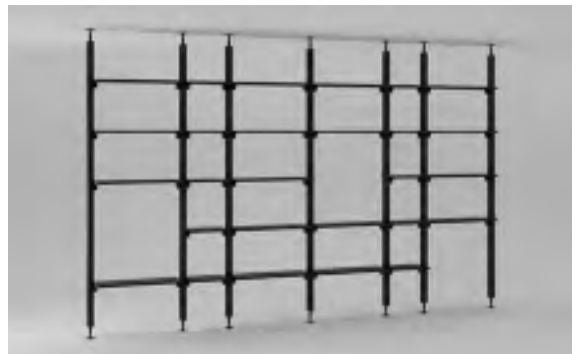

kit
ceiling version

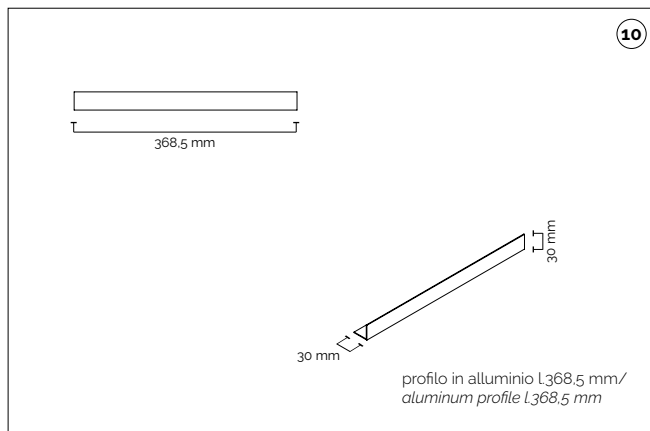
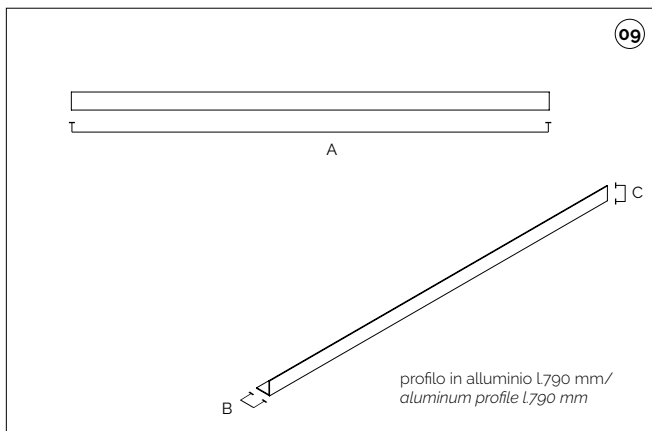
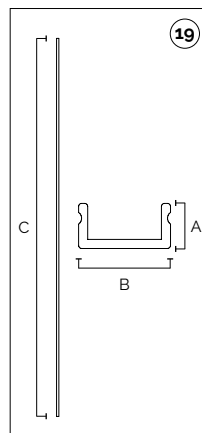
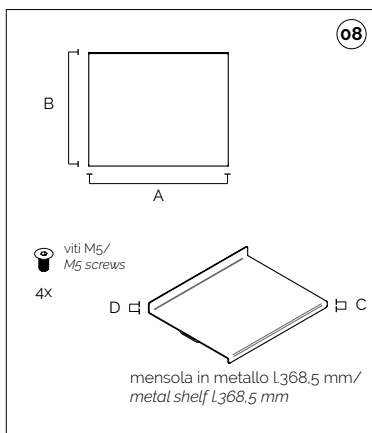
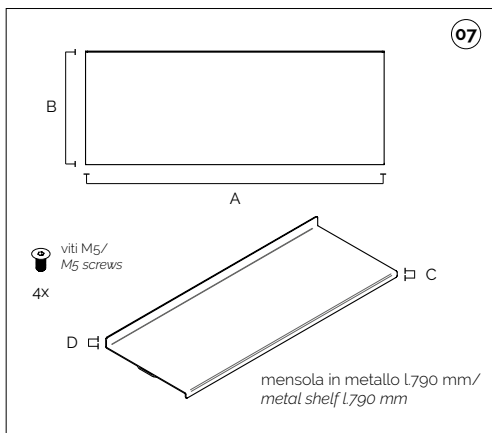
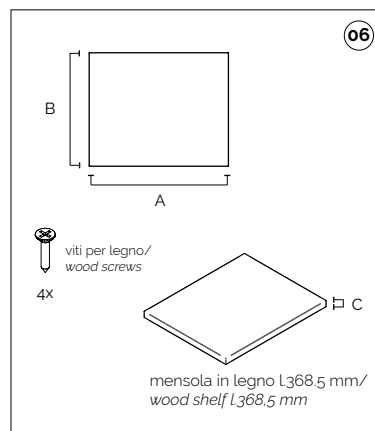
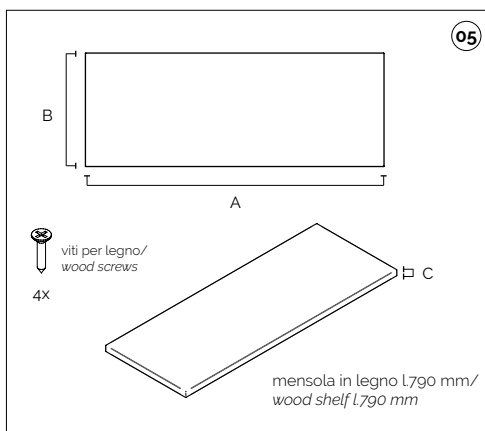
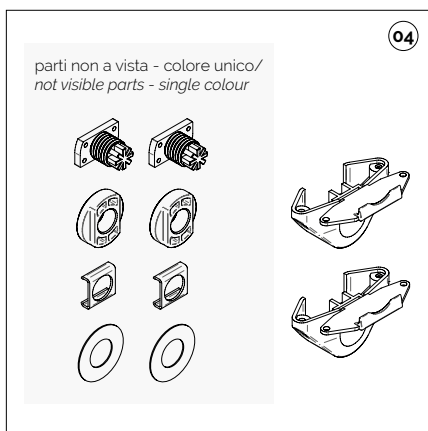
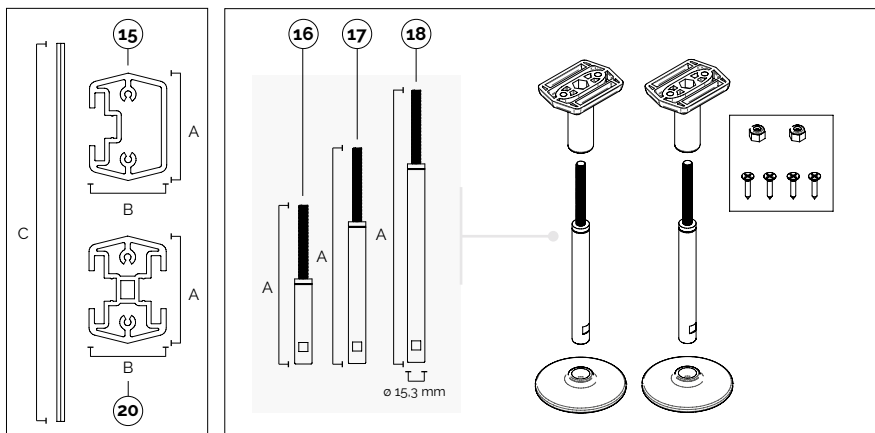

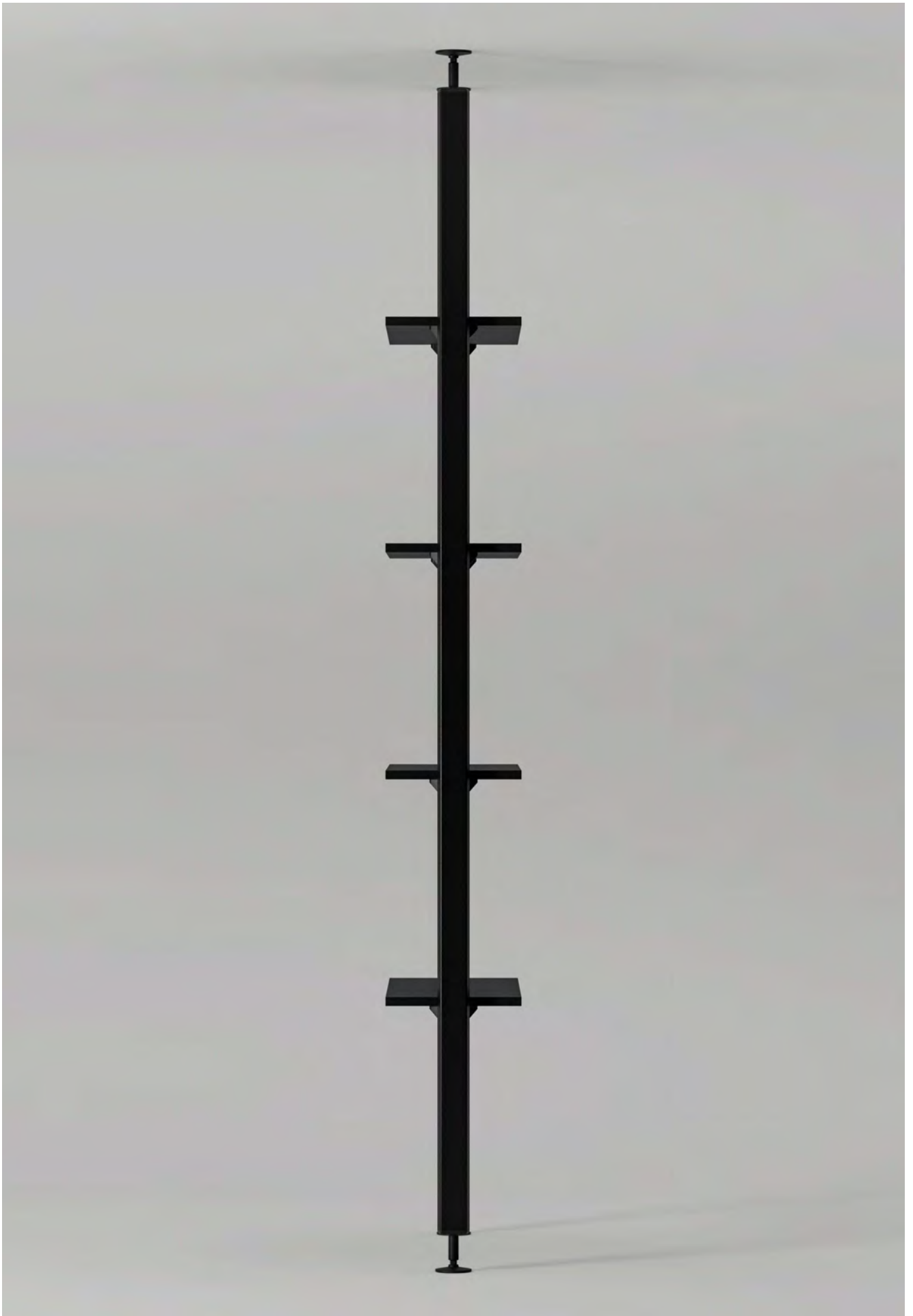



wing



discover more about
Wing Collection

Wing, 3 grands avantages pour une seule assise. Un design caractéristique et un grand confort, surtout grâce à ses deux ailettes caractéristiques. Extrêmement fonctionnelle et polyvalente, la monocoque de cette assise est prévue dans 5 couleurs différentes et avec plusieurs châssis et accessoires en option.

Wing est une nouvelle proposition d'assise pour le secteur professionnel et pour la maison.

Wing: 3 grandes ventajas en un asiento. Diseño distintivo y máximo confort, sobre todo, por las dos alas características. Sumamente funcional y versátil, existe en 5 variantes de color para la monocarcasa y presenta distintas estructuras y accesorios como opcionales.

Wing es la nueva propuesta de asiento para el ambiente del contract y el ambiente de la casa.

Plus

- Un grand impact esthétique grâce à un design caractéristique.
- Un confort extrême grâce à son ample monocoque.
- Elle est facile à nettoyer et à déplacer.
- *Gran impacto estético con su diseño distintivo.*
- *Extremo confort con su amplia monocarcasa.*
- *Fácil de limpiar y de cambiar de sitio.*



designed by:
Shannon Sadler



**outdoor
ready**



**UV plastic
protection**

wing

slide



plastic colours

- ivoire/marfil ral1013
- corail/coral 1797u
- noisette/avellana 2312u
- noir/negro ral9005
- bleu/azul 541u

01 02 03 04 05 07 08
optional

main component sizes

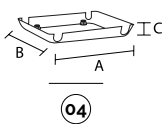
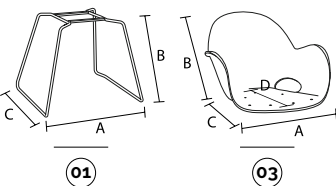

optionals

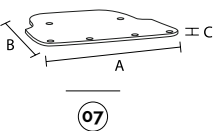

01 châssis coulissant tige d.12
estructura patin de varilla d.12

code	finishing	q.kit	q.pack	a	b	c	kg.x1	vol.x1
113410-400	● chromé/cromado	x1	100	540	525	440	3,54	mc. 0.026

02 pack de bases a pince anti-rotation pour tige couleur neutre
paquete de bases con pinza antirotacion para varilla de color neutro

code	finishing	q.kit	q.pack
137006-070	○ neutre/neutro	x4	200

03 monocoque avec accoudoirs (anti-uv)
monocarcasa con brazos (anti-uv)

code	finishing	q.kit	q.pack	a	b	c	d	kg.x1	vol.x1
133905-042	● ivoire/marfil ral1013	x1	5	570	430	590	410	2,9	mc. 0.041

04 couverture en plastique (anti-uv)
cubierta de plástico (anti-uv)

code	finishing	q.kit	q.pack	a	b	c	kg.x1
132205-039	● ivoire/marfil ral1013	x1	25	265	250	40	0,15

05 vis tsp+m6x25 zinguée blanche (vis pour fixation coque avec couverture)
tornillo tsp+m6x25 galvanizado blanco (tornillo para fijación carcasa con cubierta)

code	finishing	q.kit
117711-199	● zinguée blanc/galvanizado blanco	x4

07 panneau assise multicouche avec 6 embouts m4
panel asiento multicapa con 6 terminales m4

code	finishing	q.kit	q.pack	a	b	c	kg.x1	vol.x1
122207-023	● hêtre/haya	x1	20	376	370	5	0,3	mc. 0.0019

08 vis tbcl m4x10 zinguée blanche (vis pour fixation panneau assise)
tornillo tbcl m4x10 galvanizado blanco (tornillo para fijación panel asiento)

code	finishing	q.kit
117711-126	● zinguée blanc/galvanizado blanco	x6



for all colour codes, see page 151

wing

slide

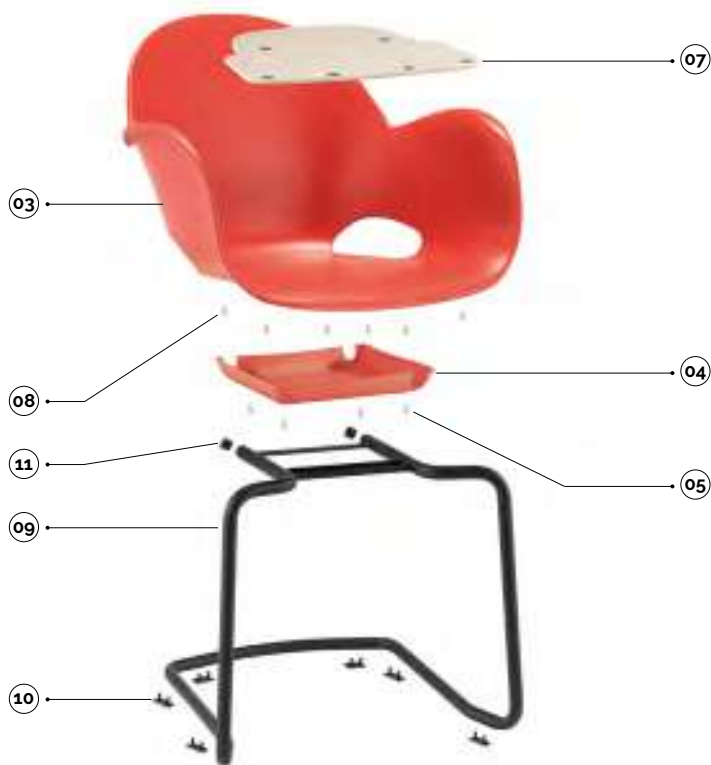

09 10 03 04 05 07 08 11
optional

plastic colours

- ivoire/marfil ral1013
- corail/coral 1797u
- noisette/avellana 2312u
- noir/negro ral9005
- bleu/azul 541u

main component sizes

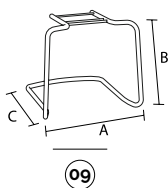

09 **châssis luge d.22 sans embouts**
estructura cantilever d.22 sin tapones

code	finishing	q.kit	q.pack	a	b	c	kg.x1	vol.x1
110503-480	● noir/negro	x1	64	510	450	500	3,77	mc. 0.0313
110505-480	● ivoire/marfil ral1013	x1	64	510	450	500	3,77	mc. 0.0313
110504-480	● gris/gris	x1	64	510	450	500	3,77	mc. 0.0313
110510-480	● chromé/cromado	x1	64	510	450	500	3,77	mc. 0.0313

10 **pince deux broches en polyéthylène noire**
pinza dos ganchos de polietileno negra

code	finishing	q.kit	kg.x1
134003-003	● noir/negro	x6	0,05

11 **embout couvre-tête d.22 pour luge**
tapón embellecedor d.22 para cantilever

code	finishing	q.kit
134103-200	● noir/negro	x2

for the components below, see previous page

03 04 05 07 08



for all colour codes, see page 151

wing

4-legs



plastic colours

- ivoire/marfil ral1013
- corail/coral 1797u
- noisette/avellana 2312u
- noir/negro ral9005
- bleu/azul 541u

main component sizes

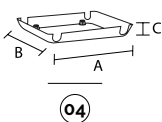
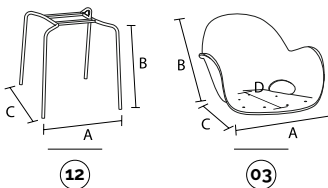

optionals

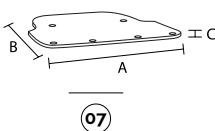

12 châssis 4 pieds d.16 sans embouts estructura 4 patas d.16 sin tapones

code	finishing	q.kit	q.pack	a	b	c	kg.x1	vol.x1
110603-613	● noir/negro	x1	200	415	445	520	2.05	mc. 0.014
110605-613	● ivoire/marfil ral1013	x1	200	415	445	520	2.05	mc. 0.014
110604-613	● gris/gris	x1	200	415	445	520	2.05	mc. 0.014
110610-613	● chromé/cromado	x1	200	415	445	520	2.05	mc. 0.014
110603-614	● noir/negro *pour exterieur/para exterior	x1	200	415	445	520	2.05	mc. 0.014
110605-614	● ivoire/marfil ral1013 *pour exterieur/para exterior	x1	200	415	445	520	2.05	mc. 0.014
110604-614	● gris/gris *pour exterieur/para exterior	x1	200	415	445	520	2.05	mc. 0.014

13 embout rond d.16 noir tapon redondo d.16 negro

code	finishing	q.kit
134203-160	● noir/negro	x4

03 monocoque avec accoudoirs (anti-uv) monocarcasa con brazos (anti-uv)

code	finishing	q.kit	q.pack	a	b	c	d	kg.x1	vol.x1
133905-042	● ivoire/marfil ral1013	x1	5	570	430	590	410	2.9	mc. 0.041

04 couverture en plastique (anti-uv) cubierta de plástico (anti-uv)

code	finishing	q.kit	q.pack	a	b	c	kg.x1
132205-039	● ivoire/marfil ral1013	x1	25	265	250	40	0.15

05 vis tsp+m6x25 zinguée blanche (vis pour fixation coque avec couverture) tornillo tsp+m6x25 galvanizado blanco (tornillo para fijación carcasa con cubierta)

code	finishing	q.kit
117711-199	● zinguée blanc/galvanizado blanco	x4

07 panneau assise multicouche avec 6 embouts m4 panel asiento multicapa con 6 terminales m4

code	finishing	q.kit	q.pack	a	b	c	kg.x1	vol.x1
122207-023	● hêtre/haya	x1	20	376	370	5	0.3	mc. 0.0019

08 vis tbcl m4x10 zinguée blanche (vis pour fixation panneau assise) tornillo tbcl m4x10 galvanizado blanco (tornillo para fijación panel asiento)

code	finishing	q.kit
117711-126	● zinguée blanc/galvanizado blanco	x6



for all colour codes, see page 151

wing

wooden 4-legs



plastic colours

- ivoire/marfil ral1013
- corail/coral 1797u
- noisette/avellana 2312u
- noir/negro ral9005
- bleu/azul 541u

14 03 15 07 08
optional

main component sizes

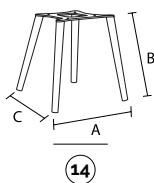

14 kit 4 pieds bois hêtre transparent + plaque de métal
kit 4 patas madera de haya transparente + placa de metal

code	finishing	plate colour	q.kit	a	b	c
120107-000	• hêtre/haya	noir/negro	x1	420	440	490
120107-001	• hêtre/haya	blanc/blanco	x1	420	440	490

15 vis tbl combi m6x16 zinguée blanche (vis pour fixation coque sans couverture) bois
tornillo tbl combi m6x16 galvanizado blanco (tornillo para fijación carcasa sin cubierta) madera

code	finishing	q.kit
117711-191	• zinguée blanc/galvanizado blanco	x4

for the components below, see previous page

03 07 08



for all colour codes, see page 151

wing

swivel



plastic colours

- ivoire/marfil ral1013
- corail/coral 1797u
- noisette/avellana 2312u
- noir/negro ral9005
- bleu/azul 541u

main component sizes

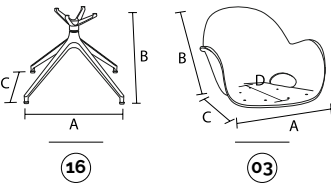

optionals

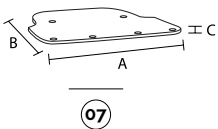

16 03 06 07 08
optional

16 base à 4 branches d.720 en aluminum
base de 4 radios d.720 de aluminio

code	finishing	q.kit	q.pack	a	b	c	kg.x1
110210-090	● aluminium/aluminio	x1	6	515	415	515	4.03

03 monocoque avec accoudoirs (anti-uv)
monocarcasa con brazos (anti-uv)

code	finishing	q.kit	q.pack	a	b	c	d	kg.x1	vol.x1
133903-040	● noir/negro ral9005	x1	5	570	430	590	410	2.9	mc. 0.041

06 vis tbl combi m6x12 zinguée blanche (vis pour fixation coque sans couverture)
tornillo tbl combi m6x12 galvanizado blanco (tornillo para fijación carcasa sin cubierta)

code	finishing	q.kit
117711-206	● zinguée blanc/galvanizado blanco	x4

07 panneau assise multicouche avec 6 embouts m4
panel asiento multicapa con 6 terminales m4

code	finishing	q.kit	q.pack	a	b	c	kg.x1	vol.x1
122207-023	● hêtre/haya	x1	20	376	370	5	0.3	mc. 0.0019

08 vis tbl m4x10 zinguée blanche (vis pour fixation panneau assise)
tornillo tbl m4x10 galvanizado blanco (tornillo para fijación panel asiento)

code	finishing	q.kit
117711-126	● zinguée blanc/galvanizado blanco	x6

➔ for all colour codes, see page 151

wing

swivel



plastic colours

- ivoire/marfil ral1013
- corail/coral 1797u
- noisette/avellana 2312u
- noir/negro ral9005
- bleu/azul 541u

main component sizes



17



18

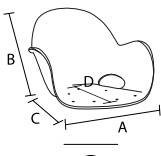

03

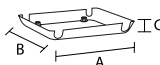

04

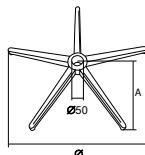

05

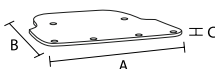

07

optionals

17 03 18 04 05 07 08 19
optional

17 g2p(01) gnr - plaque pour structure pivotante noir
g2p(01) gnr - placa para estructura giratoria negra

code	finishing	q.kit	q.pack	kg.x1	vol.x1
110903-000	● noir/negro	x1	25	0,85	mc. 0.0008

18 bloc en aluminium ø' d.28 x gaz avec levier noir opaque
bloque de aluminio ø' d.28 x gas con palanca negro opaco

code	finishing	q.kit	q.pack	kg.x1	vol.x1
110903-100	● noir/negro	x1	1	0,305	mc. 0.0225

03 monocoque avec accoudoirs (anti-uv)
monocarcasa con brazos (anti-uv)

code	finishing	q.kit	q.pack	a	b	c	d	kg.x1	vol.x1
133915-042	● bleu/azul 541u	x1	5	570	430	590	410	2,9	mc. 0.041

04 couverture en plastique (anti-uv)
cubierta de plástico (anti-uv)

code	finishing	q.kit	q.pack	a	b	c	kg.x1
132215-039	● bleu/azul 541u	x1	25	265	250	40	0,15

05 vis tsp+m6x25 zinguée blanche (vis pour fixation coque avec couverture)
tornillo tsp+m6x25 galvanizado blanco (tornillo para fijación carcasa con cubierta)

code	finishing	q.kit
117711-199	● zinguée blanc/galvanizado blanco	x4

07 panneau assise multicouche avec 6 embouts m4
panel asiento multicapa con 6 terminales m4

code	finishing	q.kit	q.pack	a	b	c	kg.x1	vol.x1
122207-023	● hêtre/haya	x1	20	376	370	5	0,3	mc. 0.0019

08 vis tbcl m4x10 zinguée blanche (vis pour fixation panneau assise)
tornillo tbcl m4x10 galvanizado blanco (tornillo para fijación panel asiento)

code	finishing	q.kit
117711-126	● zinguée blanc/galvanizado blanco	x6

19 base en métal d.640 avec cache-soudure
base de metal d.640 con embellecedor soldadura

code	finishing	q.kit	q.pack	ø	a	kg.x1	vol.x1
110210-057	● chromé/cromado	x1	5	640	112	2,25	mc. 0.0117



for all colour codes, see page 151

wing

bench

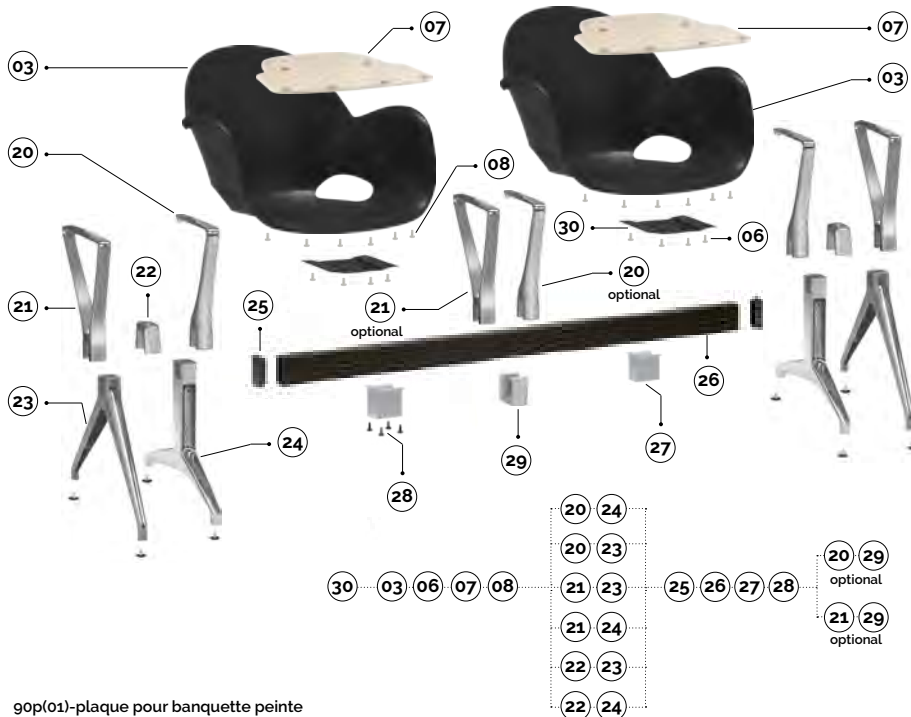

plastic colours

- ivoire/marfil ral1013
- corail/coral 1797u
- noisette/avellana 2312u
- noir/negro ral9005
- bleu/azul 541u



30

main component sizes



20



21

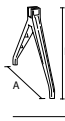

22

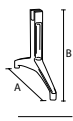

23

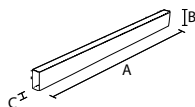

24



25



26



27

03 06 07 08

for the components below, see previous pages

for the bench components, see page 417



plastic



metal

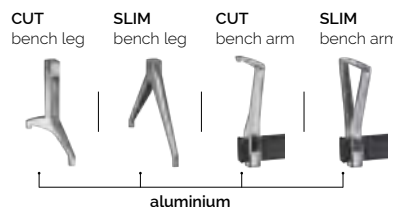

aluminium

30 90p(01)-plaque pour banquette peinte 90p(01)-placa para bancada pintada

code	finishing	q.kit	q.pack	kg.x1	vol.x1
110703-013	● noir/negro	x1	25	0,85	mc. 0,0008
110704-078	● gris/gris	x1	25	0,85	mc. 0,0008

20 cut-accoudoir en aluminium pour banquette + 2 vis cut-brazo de aluminio para bancada + n.2 tornillos

code	finishing	q.kit	q.pack	a	b	kg.x1	vol.x1
111704-223	● aluminium/aluminio	x1	10	300	305	1,40	mc. 0,0011

21 slim-accoudoir en aluminium pour banquette + 2 vis slim-brazo de aluminio para bancada + n.2 tornillos

code	finishing	q.kit	q.pack	a	b	kg.x1	vol.x1
111704-225	● aluminium/aluminio	x1	10	325	305	1,40	mc. 0,0011

22 cut/slim-cavalier en aluminium pour pied banquette + 2 vis cut/slim caballete de aluminio para pata bancada + n.2 tornillos

code	finishing	q.kit	q.pack	kg.x1	vol.x1
111704-222	● aluminium/aluminio	x1	10	0,40	mc. 0,0012

23 slim-pied en aluminium pour banquette + 2 pieds slim-pata de aluminio para bancada + n.2 pies

code	finishing	q.kit	q.pack	a	b	kg.x1	vol.x1
111704-226	● aluminium/aluminio	x2	5	610	350	1,20	mc. 0,014

24 cut-pied en aluminium pour banquette + 2 pieds cut-pata de aluminio para bancada + n.2 pies

code	finishing	q.kit	q.pack	a	b	kg.x1	vol.x1
111704-224	● aluminium/aluminio	x2	5	610	350	2,55	mc. 0,014

25 embout couvre-tête rectangulaire 80x40 noir tapón embellecedor rectangular 80 x 40 negro

code	finishing	q.kit
134103-001	● noir/negro	x2

26 got(03) poutre pour banquette 80x40 got(03) viga para bancada 80x40

code	finishing		q.kit	q.pack	a	b	c	kg.x1	vol.x1
110703-190	● noir/negro	2 places / 2 asientos	x1	1	1160	80	40	3,20	mc. 0,0045
110704-190	● gris/gris	2 places / 2 asientos	x1	1	1160	80	40	3,20	mc. 0,0045
110703-191	● noir/negro	3 places / 3 asientos	x1	1	1710	80	40	4,71	mc. 0,005
110704-191	● gris/gris	3 places / 3 asientos	x1	1	1710	80	40	4,71	mc. 0,005
110703-192	● noir/negro	4 places / 4 asientos	x1	1	2260	80	40	6,22	mc. 0,0085
110704-192	● gris/gris	4 places / 4 asientos	x1	1	2260	80	40	6,22	mc. 0,0085
110703-193	● noir/negro	5 places / 5 asientos	x1	1	2800	80	40	7,72	mc. 0,01
110704-197	● gris/gris	5 places / 5 asientos	x1	1	2800	80	40	7,72	mc. 0,01

27 govc-cavalier pour dessous poutre govc-caballete bajo viga

code	finishing	q.kit	q.pack	a	b	kg.x1	vol.x1
110703-007	● noir/negro	x1	50	55	65	0,60	mc. 0,0005
110704-016	● gris/gris	x1	50	55	65	0,60	mc. 0,0005

28 pack vis m8x12 tête cylindrique hexagonale encaissée brunie noire paquete de tornillos m8x12 cabeza cilíndrica hexagonal embutida bruñido negro

code	finishing	q.kit	q.pack
117003-070	● noir/negro	x4	200

29 cut/slim-cavalier en aluminium pour accoudoir banquette cut/slim caballete de aluminio para brazo bancada

code	finishing	q.kit	q.pack	kg.x1	vol.x1
111704-221	● aluminium/aluminio	x1	10	0,32	mc. 0,0012

wing

optional colour codes



plastic colour codes



03 scocca a pozzetto con braccioli (anti-uv)
plastic shell with arms (anti-uv)

- 133905-042 ivoire/marfil rat1013
- 133902-042 corail/coral 1797u
- 133907-042 noisette/avellana 2312u
- 133903-040 noir/negro ral9005
- 133915-042 bleu/azul 541u



04 copertina in plastica (anti-uv)
plastic cover (anti-uv)

- 132205-039 ivoire/marfil rat1013
- 132202-039 corail/coral 1797u
- 132207-039 noisette/avellana 2312u
- 132203-039 noir/negro ral9005
- 132215-039 bleu/azul 541u





feel



discover more about
Feel Collection

Une assise polyvalente au design caractéristique. Confortable et possédant un style dynamique, grâce au double design frontal/postérieur du dossier. 5 châssis sont proposés mais aussi de nombreux accessoires. Les châssis pour accoudoirs et tablettes sont par ailleurs disponibles pour l'aménagement de salles de formation.

Feel est idéal pour les environnements professionnels et domestiques mais aussi pour l'outdoor grâce à une peinture spécifique appliquée sur les châssis.

El asiento versátil y con un diseño distintivo. Con su doble diseño frontal/trasero del respaldo resulta confortable y ofrece un diseño resuelto. Existe en 5 estructuras entre las que elegir y ofrece numerosos accesorios. Disponibilidad también de estructuras para brazos y estructuras para pala, para el uso en ambientes destinados a la formación.

Feel es ideal para los ambientes del contract y de la casa, también en el exterior con su pintura específica aplicada a las estructuras.

Plus

- 8 couleurs de tendance pour la coque.
- Empilable avec un châssis traîneau et 4 pieds.
- Elle est proposée avec un petit panneau en plastique à tapisser et des crochets latéraux pratiques.
- Certification EN 16139:2013+AC2013 Niveau 1.
- Certification ANSI/BIFMA X5.1.
- 8 colores de moda para la carcasa.
- Apilable con estructura de patín y de 4 patas.
- Disponible con galleta tapizable de plástico y prácticos enganches laterales.
- Doble certificación BIFMA y CATAS.
- Certificación EN 16139:2013+AC2013 Nivel 1.
- Certificación ANSI/BIFMA X5.1.



designed by:
Stefano Bettio



**outdoor
ready**



**trolley
available**



**certified
product**

feel

slide



CERTIFIED BY
BIFMA

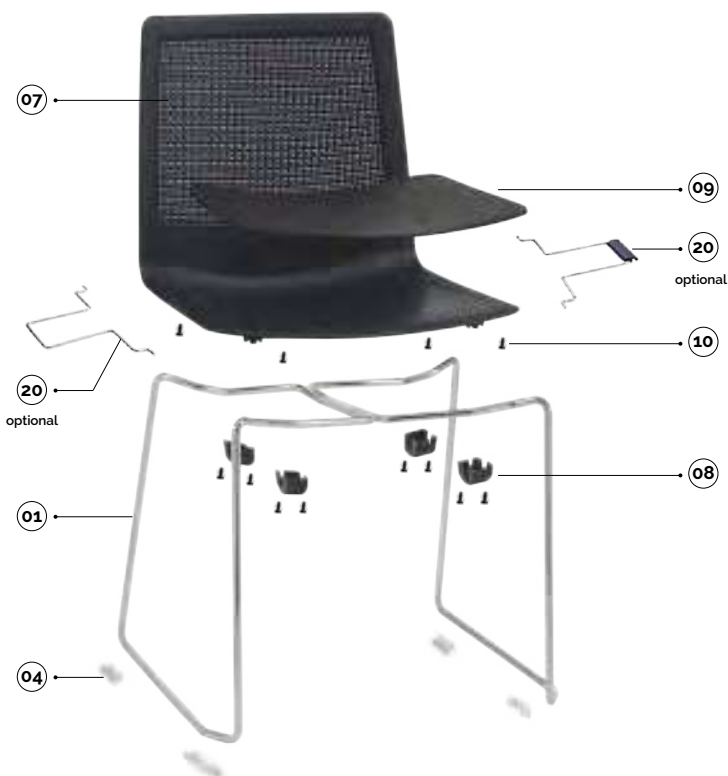

- bleu/azul ral5014
- orange/naranja ral2003
- noir/negro ral9005
- vert/verde pantone 7495el
- blanc/blanco 218
- gris/gris ral7003
- sable/arena ral1019
- rouge/rojo ral527
- blanc autoextinguible/
blanco autoextinguidor 218

plastic colours

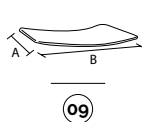
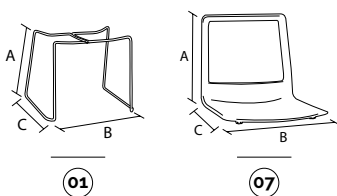

main component sizes

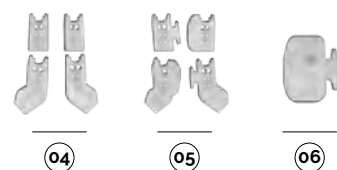

optionals

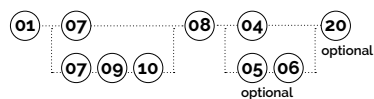

01 feel-châssis coulissant tige 012 feel-estructura patin de varilla d. 12

code	finishing	q.kit	q.pack	a	b	c	kg.x1	vol.x1
113410-057	● chromé/cromado	x1	100	460	530	470	3,75	mc. 0.03

04 btf-kit pieds btf-kit pies

code	finishing	q.kit	q.pack	kg.x1
134306-001	○ neutre/neutro	x1	100	0,05

05 btfa-kit pieds avec crochets btfa-kit pies con ganchos

code	finishing	q.kit	q.pack	kg.x1
134306-002	○ neutre/neutro	x1	100	0,06

06 pptf-embout pour fixation au sol pptf-tapón para fijación en el pavimento

code	finishing	q.kit	q.pack	kg.x1
134306-003	○ neutre/neutro	x2	100	0,03

07 feel-coque entière modèle feel feel-carcasa completa modelo feel

code	finishing	q.kit	q.pack	a	b	c	kg.x1	vol.x1
133903-060	● noir/negro ral9005	x1	10	420	450	430	1,70	mc. 0.02

08 feel-pack accessoires en tige pour coque feel feel-paquete de accesorios para carcasa feel para varilla

code	finishing	q.kit	q.pack	kg.x1	vol.x1
137003-061	● noir/negro ral9005	x1	10	wire frame	0,07 mc. 0.001

09 feel-panneau assise à revêtir feel-galleta asiento tapizable

code	finishing	q.kit	q.pack	a	b	kg.x1	vol.x1
132203-059	● noir/negro	x1	25	400	440	0,6	mc. 0.003

10 vis hilo tb+ 5x14 zinguée noire (pour fixer le panneau du siège) tornillo hi-lo tb+ 5x14 galvanizado negro (para fijar galleta asiento)

code	finishing	q.kit
117803-155	● noir/negro	x8

20 paire de grappins d'attelage latéral tige + plastique noir feel-pareja de enganches laterales de varilla + plástico negro

code	finishing	q.kit	kg.x1	vol.x1
113410-056	● chromé/cromado	x1	0,15	mc. 0.002



feel

slide w/armrests



- bleu/azul ral5014
- orange/naranja ral2003
- noir/negro ral9005
- vert/verde pantone 7495el
- blanc/blanco 218
- gris/gris ral7003
- sable/arena ral1019
- rouge/rojo ral527
- blanc autoextinguible/
blanco autoextinguidor 218

plastic colours

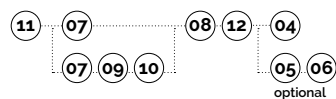
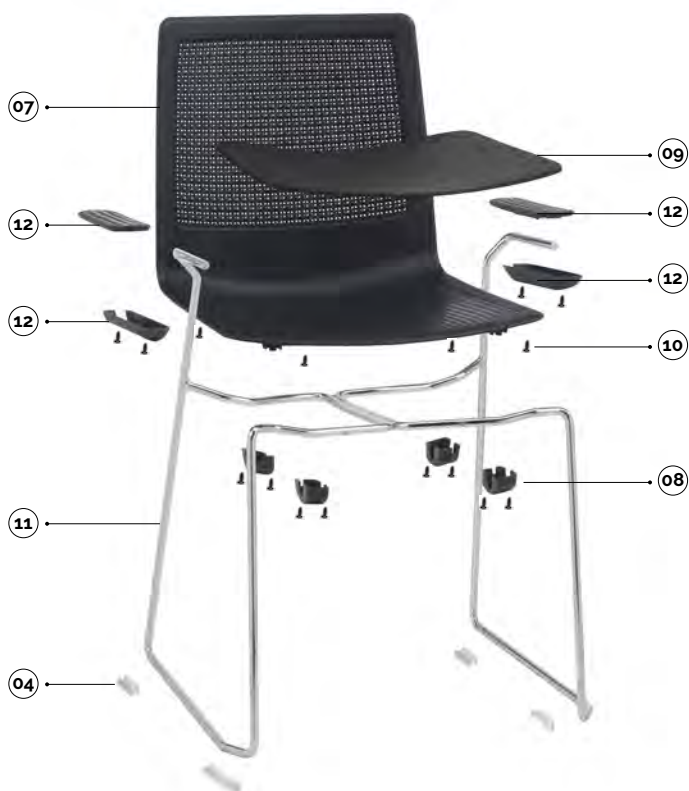

main component sizes

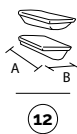
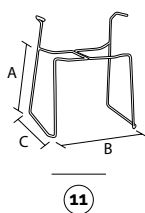

11 feel-châssis coulissant tige ø12 avec accoudoirs
feel-estructura patin de varilla d. 12 con brazos

code	finishing	q.kit	q.pack	a	b	c	kg.x1	vol.x1
113410-058	● chromé/cromado	x1	60	460	530	470	4,50	mc. 0.035

12 feel-paire d'accoudoirs en plastique colorés + vis
feel-pareja de brazos de plástico de color + tornillos

code	finishing	q.kit	q.pack	a	b	kg.x1	vol.x1
131703-062	● noir/negro ral9005	x1	20	right + left	200 30	0,16	mc. 0.001

for the components below, see previous page

04 05 06 07 08 09 10



for all colour codes, see page 163



feel-chariot porte-chaises noir avec accessoires
feel-carro para sillas con accesorios negro

code	finishing	q.kit
110803-329	● noir/negro	x1

feel

slide w/writing tablet



plastic colours

- bleu/azul ral5014
- orange/naranja ral2003
- noir/negro ral9005
- vert/verde pantone 7495el
- blanc/blanco 218
- gris/gris ral7003
- sable/arena ral1019
- rouge/rojo ral527
- blanc autoextinguible/blanco autoextinguidor 218

main component sizes

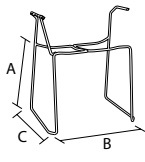

13



14



15

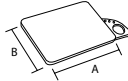

16

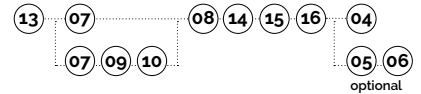

13 feel-châssis coulissant tige ø 12 avec accoudoirs et porte-tablette
feel-estructura patin de varilla d. 12 con brazos y pala

code	finishing	q.kit	q.pack	a	b	c	kg.x1	vol.x1
113410-072	● chromé/cromado right writing tablet hook	x1	30	460	530	470	5,00	mc. 0,07
113410-073	● chromé/cromado left writing tablet hook	x1	30	460	530	470	5,00	mc. 0,07

14 feel-paire d'accoudoirs en plastique colorés pour tablette + vis
feel-pareja de brazos de plástico de color para pala + tornillos

code	finishing	q.kit	q.pack	a	b	kg.x1	vol.x1
131703-063	● noir/negro ral9005	x1	20	right-left for tablet	200 30	0,16	mc. 0,0045
131703-064	● noir/negro ral9005	x1	20	left-right for tablet	200 30	0,16	mc. 0,0045

15 spt2-rotule pour tablette en thermoplastique
spt2-articulación para pala de termoplástico

code	finishing	q.kit	q.pack	a	b	c	kg.x1	vol.x1
134003-039	● noir/negro	x1	20	180	66	15x15	0,35	mc. 0,0006

16 tlt3-tablette ambidextre avec porte-verre et porte-stylos
tlt3-pala diestros con hueco vasos y lapicero

code	finishing	q.kit	q.pack	a	b	kg.x1	vol.x1
134003-041	● noir/negro	x1	10	410	300		1,05 mc. 0,036

for the components below, see previous pages

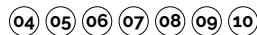

for all colour codes, see page 163

TLT
tablet



TLT2
tablet

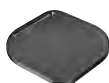

TLT3
tablet



BEAN
tablet



TL02
tablet



SPT2
mechanism tablet



SPTA
mechanism antipanic



for writing tablet options, see page 404/405

feel

stool

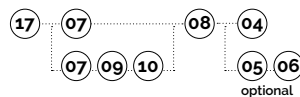
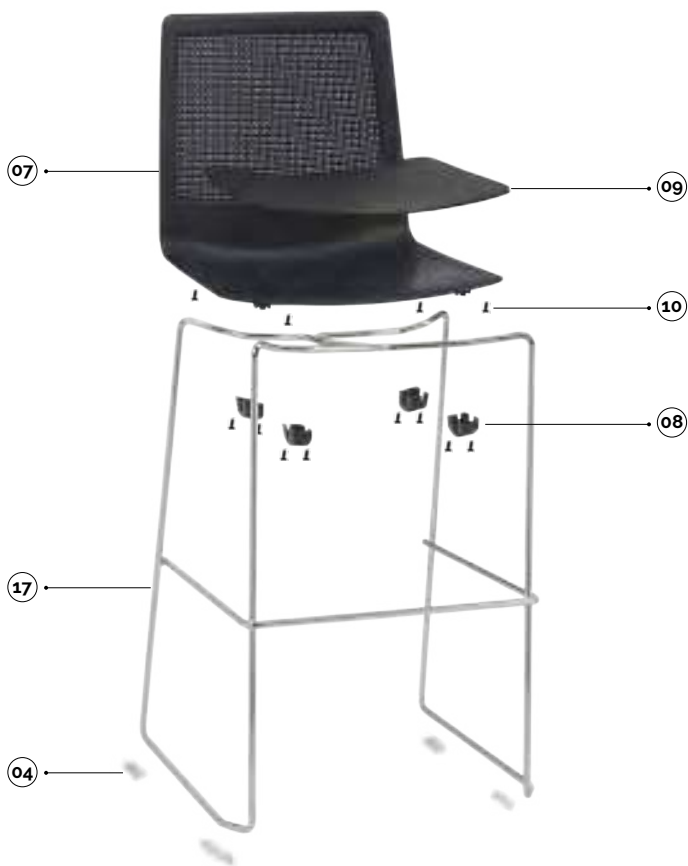

plastic colours

- bleu/azul ral5014
- orange/naranja ral2003
- noir/negro ral9005
- vert/verde pantone 7495el
- blanc/blanco 218
- gris/gris ral7003
- sable/arena ral1019
- rouge/rojo ral527
- blanc autoextinguible/blanco autoextinguidor 218

main component sizes

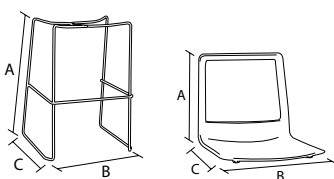

17

07



09

optionals



04

05

06

17 feel-tabouret haut h730 tige ø12 pour coque sans embouts
feel-taburete alto h730 de varilla d. 12 para carcasa sin tapones

code	finishing	q.kit	q.pack	a	b	c	kg.x1	vol.x1
113410-059	● chromé/cromado	x1	50	730	530	500	6,20	mc. 0,08

04 btf-kit pieds
btf-kit pies

code	finishing	q.kit	q.pack	kg.x1
134306-001	○ neutre/neutro	x1	100	0,05

05 btfa-kit pieds avec crochets
btfa-kit pies con ganchos

code	finishing	q.kit	q.pack	kg.x1
134306-002	○ neutre/neutro	x1	100	0,06

06 pptf-embout pour fixation au sol
pptf-tapón para fijación en el pavimento

code	finishing	q.kit	q.pack	kg.x1
134306-003	○ neutre/neutro	x2	100	0,03

07 feel-coque entière modèle feel
feel-carcasa completa modelo feel

code	finishing	q.kit	q.pack	a	b	c	kg.x1	vol.x1
133903-060	● noir/negro ral9005	x1	10	420	450	430	1,70	mc. 0,02

08 feel-pack accessoires en tige pour coque feel
feel-paquete de accesorios para carcasa feel para varilla

code	finishing	q.kit	q.pack	kg.x1	vol.x1
137003-061	● noir/negro ral9005	x1	10	telaio in tondino/wire frame	0,07 mc. 0,001

09 feel-panneau assise à revêtir
feel-galleta asiento tapizable

code	finishing	q.kit	q.pack	a	b	kg.x1	vol.x1
132203-059	● noir/negro	x1	25	400	440	0,6	mc. 0,003

10 vis hilo tb+ 5x14 zinguée noire (pour fixer le panneau du siège)
tornillo hi-lo tb+ 5x14 galvanizado negro (para fijar galleta asiento)

code	finishing	q.kit
117803-155	● noir/negro	x8



for all colour codes, see page 163

feel

4-legs



CERTIFIED BY
CATAS

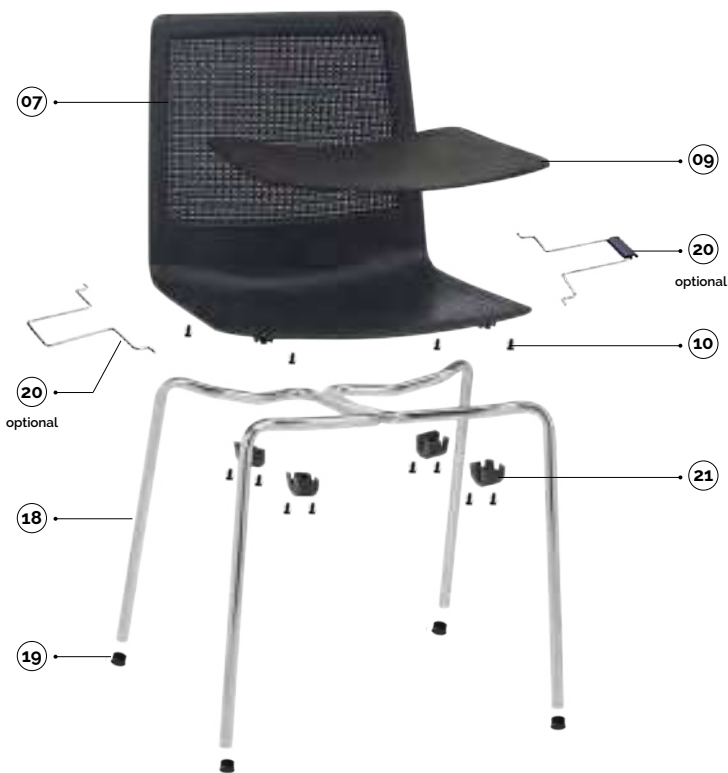

- bleu/azul ral5014
- orange/naranja ral2003
- noir/negro ral9005
- vert/verde pantone 7495el
- blanc/blanco 218
- gris/gris ral7003
- sable/arena ral1019
- rouge/rojo ral527
- blanc autoextinguible/
blanco autoextinguidor 218

plastic colours

main component sizes

optionals

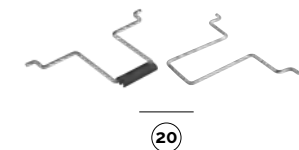
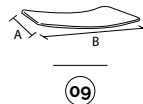
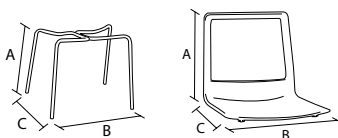

18 feel-châssis 4 pieds tube ø18 sans embouts feel-estructura 4 patas tubular d. 18 sin tapones

code	finishing	q.kit	q.pack	a	b	c	kg.x1	vol.x1
112703-031	● noir/negro ral9005	x1	200	440	510	500	2	mc. 0.025
112704-031	● gris/gris ral7003	x1	200	440	510	500	2	mc. 0.025
112705-031	○ blanc/blanco ral9003	x1	200	440	510	500	2	mc. 0.025
112710-031	● chromé/cromado	x1	200	440	510	500	2	mc. 0.025
112703-032'	● noir/negro ral9005 'pour extérieur/para exterior x1	x1	200	440	510	500	2	mc. 0.025
112704-032'	● gris/gris ral7003 'pour extérieur/para exterior x1	x1	200	440	510	500	2	mc. 0.025
112705-032'	○ blanc/blanco ral9003 'pour extérieur/para exterior x1	x1	200	440	510	500	2	mc. 0.025

19 pack embouts ronds ø18 noirs paquete de tacos redondos d.18 negros

code	finishing	q.kit	q.pack
137003-072	● noir/negro	x1	200
134205-181	○ blanc/blanco	x1	

07 feel-coque entière modèle feel feel-carcasa completa modelo feel

code	finishing	q.kit	q.pack	a	b	c	kg.x1	vol.x1
133903-060	● noir/negro ral9005	x1	10	420	450	430	1,70	mc. 0.02

21 feel-pack accessoires pour coque feel tube ø18 feel-paquete de accesorios para carcasa feel para tubular d.18

code	finishing	q.kit	q.pack	kg.x1	vol.x1
137003-060	● noir/negro ral9005	x1	10	telaio tubo/tube frame	0,07 mc. 0.001

09 feel-panneau assise à revêtir feel-galleta asiento tapizable

code	finishing	q.kit	q.pack	a	b	kg.x1	vol.x1
132203-059	● noir/negro	x1	25	400	440	0,6	mc. 0.003

10 vis hilo tb* 5x14 zinguée noire (pour fixer le panneau du siège) tornillo hi-lo tb* 5x14 galvanizado negro (para fijar galleta asiento)

code	finishing	q.kit
117803-155	● noir/negro	x8

20 feel-paire de grappins d'attelage latéral tige + plastique noir feel-pareja de enganches laterales de varilla + plástico negro

code	finishing	q.kit	kg.x1	vol.x1
113410-056	● chromé/cromado	x1	0,15	mc. 0.002



for all colour codes, see page 163

feel

4-legs w/armrests



- bleu/azul ral5014
- orange/naranja ral2003
- noir/negro ral9005
- vert/verde pantone 7495el
- blanc/blanco 218
- gris/gris ral7003
- sable/arena ral1019
- rouge/rojo ral527
- blanc autoextinguible/
blanco autoextinguidor 218

plastic colours

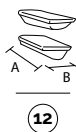
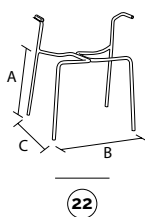
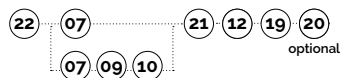

main component sizes

22 feel-châssis 4 pieds ø18 avec accoudoirs sans embouts
feel-estructura 4 patas d. 18 con brazos sin tapones

code	finishing		q.kit	q.pack	a	b	c	kg.x1	vol.x1
112703-033	● noir/negro ral9005		x1	60	440	510	500	2,6	mc. 0.035
112704-033	● gris/gris ral7003		x1	60	440	510	500	2,6	mc. 0.035
112705-033	○ blanc/blanco ral9003		x1	60	440	510	500	2,6	mc. 0.035
112710-033	● chromé/cromado		x1	60	440	510	500	2,6	mc. 0.035
112703-034'	● noir/negro ral9005 'pour extérieur/para exterior x1			60	440	510	500	2,6	mc. 0.035
112704-034'	● gris/gris ral7003 'pour extérieur/para exterior x1			60	440	510	500	2,6	mc. 0.035
112705-034'	○ blanc/blanco ral9003 'pour extérieur/para exterior x1			60	440	510	500	2,6	mc. 0.035

12 feel-paire d'accoudoirs en plastique colorés + vis
feel-pareja de brazos de plástico de color + tornillos

code	finishing		q.kit	q.pack	a	b	kg.x1	vol.x1
131703-062	● noir/negro ral9005		x1	20	right + left	200 30	0,16	mc. 0.001

for the components below, see previous pages

- 19 07 21 09 10 20



for all colour codes, see page 163

optionals

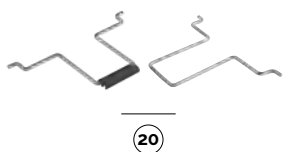

feel

4-legs w/writing tablet



plastic colours

- bleu/azul ral5014
- orange/naranja ral2003
- noir/negro ral9005
- vert/verde pantone 7495el
- blanc/blanco 218
- gris/gris ral7003
- sable/arena ral1019
- rouge/rojo ral527
- blanc autoextinguible/
blanco autoextinguidor 218

main component sizes

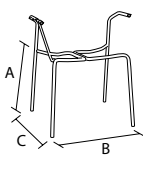

23



14



15

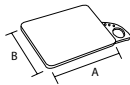

16

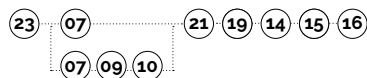

23 feel-châssis 4 pieds en tube ø18 sans embouts avec accoudoirs et porte-tablette
feel-estructura 4 patas tubular d. 18 sin tapones con brazos y pala

code	finishing		q.kit	q.pack	a	b	c	kg.x1	vol.x1
112703-037	● noir/negro ral9005 - right writ. tab. hook		x1	30	440	510	500	3,50	mc. 0.07
112704-037	● gris/gris ral7003 - right writ. tab. hook		x1	30	440	510	500	3,50	mc. 0.07
112705-037	○ blanc/blanco ral9003 - right writ. tab. hook		x1	30	440	510	500	3,50	mc. 0.07
112710-037	● chromé/cromado right writing tablet hook		x1	30	440	510	500	3,50	mc. 0.07
112703-038	● noir/negro ral9005 - left writ. tab. hook		x1	30	440	510	500	3,50	mc. 0.07
112704-038	● gris/gris ral7003 - left writ. tab. hook		x1	30	440	510	500	3,50	mc. 0.07
112705-038	○ blanc/blanco ral9003 - left writ. tab. hook		x1	30	440	510	500	3,50	mc. 0.07
112710-038	● chromé/cromado left writing tablet hook		x1	30	440	510	500	3,50	mc. 0.07

14 feel-paire d'accoudoirs en plastique colorés pour tablette + vis
feel-pareja de brazos de plástico de color para pala + tornillos

code	finishing		q.kit	q.pack	a	b	kg.x1	vol.x1
131703-063	● noir/negro ral9005	right+left for tablet	x1	20	200	30	0,16	mc. 0.0045
131703-064	● noir/negro ral9005	left+right for tablet	x1	20	200	30	0,16	mc. 0.0045

15 spt2-rotule pour tablette en thermoplastique
spt2-articulación para pala de termoplástico

code	finishing		q.kit	q.pack	a	b	c	kg.x1	vol.x1
134003-039	● noir/negro		x1	20	180	66	15x15	0,35	mc. 0.0006

16 tlt3-tablette ambidextre avec porte-verre et porte-stylos
tlt3-pala diestros con hueco vasos y lapicero

code	finishing		q.kit	q.pack	a	b	kg.x1	vol.x1	
134003-041	● noir/negro		x1	10	410	300		1,05	mc. 0.036

for the components below, see previous pages

for all colour codes, see page 163

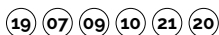

for writing tablet options, see page 404/405

feel

swivel



- bleu/azul ral5014
- orange/naranja ral2003
- noir/negro ral9005
- vert/verde pantone 7495el
- blanc/blanco 218
- gris/gris ral7003
- sable/arena ral1019
- rouge/rojo ral527
- blanc autoextinguible/blanco autoextinguidor 218

plastic colours

main component sizes

optionals

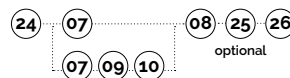
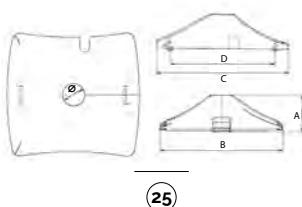
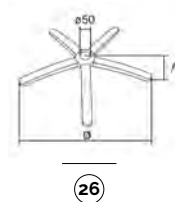
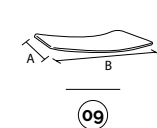
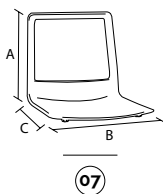
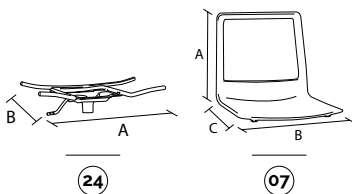

24 feel-support pivotant au gaz pour coque feel feel-soporte versión giratoria con mecanismo de gas para carcasa feel

code	finishing	q.kit	q.pack	a	b	kg.x1	vol.x1
110903-033	● noir/negro ral9005	x1	10	400	320	2,20	mc. 0,004
110904-033	● gris/gris ral7003	x1	10	400	320	2,20	mc. 0,004

07 feel-coque entière modèle feel feel-carcasa completa modelo feel

code	finishing	q.kit	q.pack	a	b	c	kg.x1	vol.x1
133903-060	● noir/negro ral9005	x1	10	420	450	430	1,70	mc. 0,02

08 feel-pack accessoires en tige pour coque feel feel-paquete de accesorios para carcasa feel para varilla

code	finishing	q.kit	q.pack	kg.x1	vol.x1
137003-061	● noir/negro ral9005	x1	10	wire frame	0,07 mc. 0,001

09 feel-panneau assise à revêtir feel-galleta asiento tapizable

code	finishing	q.kit	q.pack	a	b	kg.x1	vol.x1
132203-059	● noir/negro	x1	25	400	440	0,6	mc. 0,003

10 vis hilo tb+ 5x14 zinguée noire (pour fixer le panneau du siège) tornillo hi-lo tb+ 5x14 galvanizado negro (para fijar galleta asiento)

code	finishing	q.kit
117803-155	● noir/negro	x8

25 cpg-couverture en plastique pour châssis pivotant cpg-cubierta de plástico para estructura versión giratoria

code	finishing	q.kit	q.pack	a	b	c	d	ø	kg.x1	vol.x1
130903-000	● noir/negro	x1	50	60	200	210	167	36	0,1	mc. 0,0015

26 b40-base en métal avec cache-soudure b40-base de metal con embellecedor soldadura

code	finishing	q.kit	q.pack	a	ø	kg.x1	vol.x1
110210-027	● chromé/cromado	x1	5	60	640	2,85	mc. 0,014

CPG
plastic cover for swivel frame

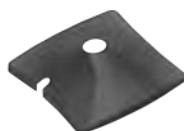

for all colour codes, see page 163

feel

bench

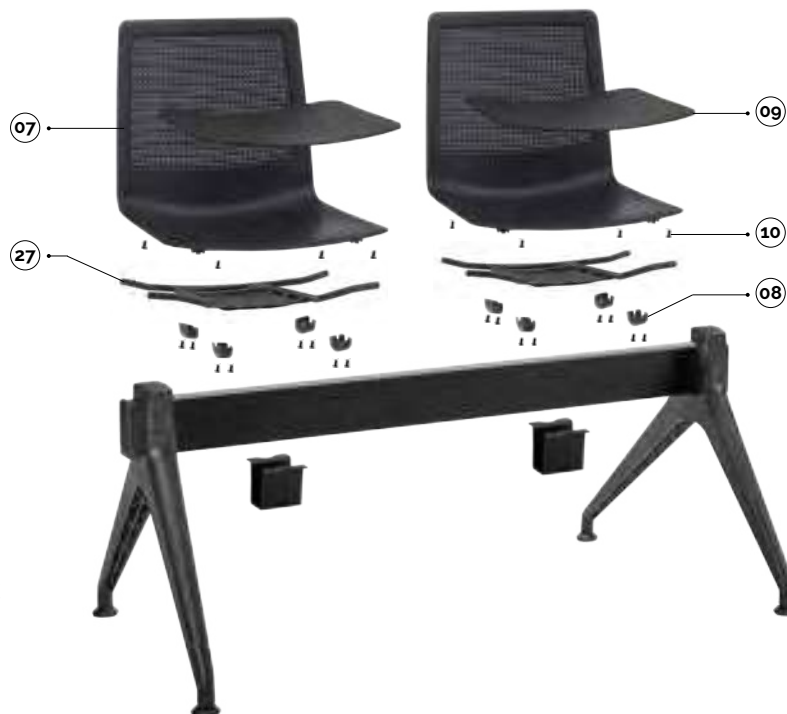

- plastic colours
- bleu/azul ral5014
 - orange/naranja ral2003
 - noir/negro ral9005
 - vert/verde pantone 7495el
 - blanc/blanco 218
 - gris/gris ral7003
 - sable/arena ral1019
 - rouge/rojo ral527
 - blanc autoextinguible/ blanco autoextinguidor 218

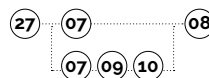

main component sizes

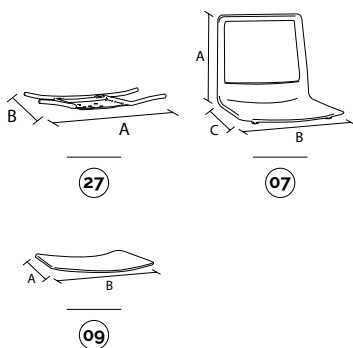

27 feel-support pour raccordement coque feel sur banquette
feel-soporte para enganche carcasa feel en bancada

code	finishing	q.kit	q.pack	a	b	kg.x1	vol.x1
110703-029	● noir/negro	x1	10	400	320	2,10	mc. 0,004

07 feel-coque entière modèle feel
feel-carcasa completa modelo feel

code	finishing	q.kit	q.pack	a	b	c	kg.x1	vol.x1
133903-060	● noir/negro ral9005	x1	10	420	450	430	1,70	mc. 0,02

08 feel-pack accessoires en tige pour coque feel
feel-paquete de accesorios para carcasa feel para varilla

code	finishing	q.kit	q.pack	kg.x1	vol.x1
137003-061	● noir/negro ral9005	x1	10	wire frame	0,07 mc. 0,001

09 feel-panneau assise à revêtir
feel-galleta asiento tapizable

code	finishing	q.kit	q.pack	a	b	kg.x1	vol.x1
132203-059	● noir/negro	x1	25	400	440	0,6	mc. 0,003

10 vis hilo tb+ 5x14 zinguée noire (pour fixer le panneau du siège)
tornillo hi-lo tb+ 5x14 galvanizado negro (para fijar galleta asiento)

code	finishing	q.kit
117803-155	● noir/negro	x8

for the bench components, see page 417



for all colour codes, see page 163

optionals

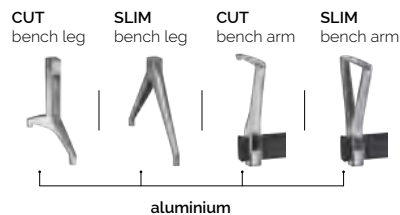
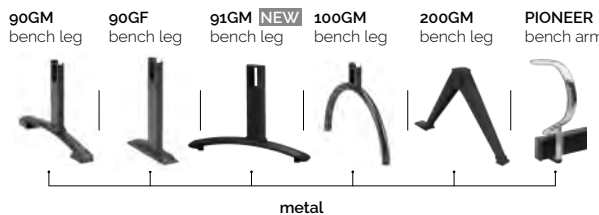
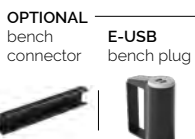

feel

optional colour codes

shell colour codes



07 coques en plastique carcasas de plástico

●	133915-060	bleu/azul ral5014
●	133907-060	orange/naranja ral2003
●	133903-060	noir/negro ral9005
●	133916-060	vert/verde pantone 7495el
○	133905-060	blanc/blanco 218
○	133904-060	gris/gris ral7003
●	133907-059	sable/arena ral1019
●	133902-060	rouge/rojo ral527

accessory and armrest colour codes



08 accessoires en plastique - châssis coulissant, pivotant, banquette accesorios de plástico - estructuras patin, giratoria, bancada

●	137015-061	bleu/azul ral5014
●	137007-061	orange/naranja ral2003
●	137003-061	noir/negro ral9005
●	137016-061	vert/verde pantone 7495el
○	137005-061	blanc/blanco 218
○	137004-061	gris/gris ral7003
●	137007-058	sable/arena ral1019
●	137002-061	rouge/rojo ral527



21 accessoires en plastique pour châssis 4 pieds accesorios de plástico para estructura 4 patas

●	137015-060	bleu/azul ral5014
●	137007-060	orange/naranja ral2003
●	137003-060	noir/negro ral9005
●	137016-060	vert/verde pantone 7495el
○	137005-060	blanc/blanco 218
○	137004-060	gris/gris ral7003
●	137007-059	sable/arena ral1019
●	137002-060	rouge/rojo ral527



12 accoudoirs en plastique pour châssis 4 pieds et coulissant brazos de plástico para estructuras 4 patas y patin

●	131715-062	bleu/azul ral5014
●	131707-062	orange/naranja ral2003
●	131703-062	noir/negro ral9005
●	131716-062	vert/verde pantone 7495el
○	131705-062	blanc/blanco 218
○	131704-062	gris/gris ral7003
●	131707-059	sable/arena ral1019
●	131702-062	rouge/rojo ral527



14 accoudoirs en plastique pour tablette pour châssis 4 pieds et coulissant brazos de plástico para pala para estructuras 4 patas y patin

●	131715-063	right + left for tablet	bleu/azul ral5014
●	131715-064	left + right for tablet	bleu/azul ral5014
●	131707-063	right + left for tablet	orange/naranja ral2003
●	131707-064	left + right for tablet	orange/naranja ral2003
●	131703-063	right + left for tablet	noir/negro ral9005
●	131703-064	left + right for tablet	noir/negro ral9005
●	131716-063	right + left for tablet	vert/verde pantone 7495el
●	131716-064	left + right for tablet	vert/verde pantone 7495el
○	131705-063	right + left for tablet	blanc/blanco 218
○	131705-064	left + right for tablet	blanc/blanco 218
○	131704-063	right + left for tablet	gris/gris ral7003
○	131704-064	left + right for tablet	gris/gris ral7003
●	131707-060	right + left for tablet	sable/arena ral1019
●	131707-061	left + right for tablet	sable/arena ral1019
●	131702-063	right + left for tablet	rouge/rojo ral527
●	131702-064	left + right for tablet	rouge/rojo ral527





moon



discover more about
Moon Collection

Une assise avec un dossier portant au design caractéristique.
Une stabilité maximale et du style grâce au dossier portant externe en plastique blanc ou noir, visible ou muni d'un panneau en complément à tapisser, pour former un ensemble avec une base traîneau ou un châssis 4 pieds.

Moon est parfaite pour une réception ou une salle de meeting.

Un asiento con un respaldo portante, para garantizar un diseño distintivo. Máxima estabilidad y estilo de la mano del respaldo externo portante de plástico, en blanco o negro, que puede ser visible o con galleta adicional tapizable y que forma un conjunto único con la base de patín y con la estructura de 4 patas.

Moon es ideal para los espacios de dirección y las salas de reunión.

Plus

- Un design caractéristique.
- Un confort extrême.
- Une stabilité maximale du châssis.
- Une qualité certifiée CATAS.
- Certification EN 15373:2007 de Niveau 3.
- Certification EN 13761:2002.
- *Diseño distintivo.*
- *Extrema comodidad.*
- *Máxima estabilidad de la estructura.*
- *Calidad certificada CATAS.*
- *Certificación EN 15373:2007 Nivel 3.*
- *Certificación EN 13761:2002.*



certified
product

moon

slide



CERTIFIED BY
CATAS

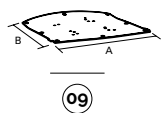
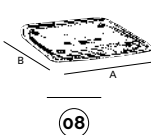
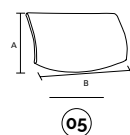
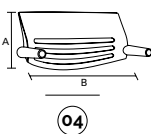
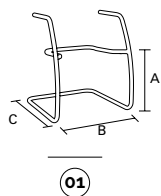
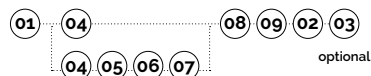

03 pied anticapotage en plastique
pie antivuelco de plástico



01 moon-base coulissante en tube asform d.25 embouts exclus
moon-base patin tubular asform d.25 tapones excluidos

code	finishing	q.kit	q.pack	a	b	c	kg.x1	vol.x1
110503-120	● noir/negro	x1	36	450	560	550	4,80	mc. 0,045
110504-120	● gris/gris ikea 4	x1	36	450	560	550	4,80	mc. 0,045
110510-120	● chromé/cromado	x1	36	450	560	550	4,80	mc. 0,045

02 p2p pince deux broches en polyéthylène noire
p2p pinza dos ganchos de polietileno negra

code	finishing	q.kit
134003-003	● noir/negro	x6

03 pied anticapotage en plastique noir
pie antivuelco de plástico negro

code	finishing	q.kit	q.pack
134303-006	● noir/negro	x2	100

04 moon-dossier externe avec accessoires
moon-respaldo externo con accesorios

code	finishing	q.kit	q.pack	a	b	kg.x1	vol.x1
132103-052	● noir/negro	x1	12	270	510	1,60	mc. 0,017
132105-052	○ blanc/blanco	x1	12	270	510	1,60	mc. 0,017

05 moon-panneau dossier en plastique à revêtir
moon-galleta respaldo de plástico tapizable

code	finishing	q.kit	q.pack	a	b	kg.x1	vol.x1
132103-053	● noir/negro	x1	20	300	400	0,29	mc. 0,003

06 vis hilo tlb+ 5x12 clipper zingué noir
tornillo hi-lo tlb+ 5x12 clipper galvanizado negro

code	finishing	q.kit
117803-151	● noir/negro	x6

07 couvre-vis clipper en plastique
embellecedor clipper de plástico

code	finishing	q.kit
134403-200	● noir/negro	x6
134405-200	○ blanc/blanco	x6

08 moon-siège interne (habillable)
moon-asiento interno (tapizable)

code	finishing	q.kit	q.pack	a	b	kg.x1	vol.x1
132203-061	● noir/negro	x1	10	490	470	1,90	mc. 0,011

09 moon-renfort d'assise externe en plastique noir + 8 vis
moon-parte inferior asiento externo de plástico negro + 8 tornillos

code	finishing	q.kit	q.pack	a	b	kg.x1	vol.x1
132203-064	● noir/negro	x1	20	470	440	0,57	mc. 0,0025

main component sizes

optionals

moon

4-legs

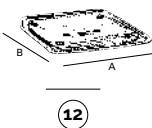
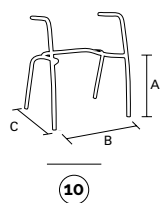
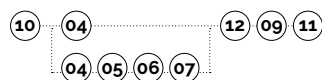

10 moon-châssis 4 pieds d.25 sans embouts
moon-estructura 4 patas d.25 sin tapones

code	finishing	q.kit	q.pack	a	b	c	kg.x1	vol.x1
112603-060	● noir/negro	x1	30	450	560	550	3,60	mc. 0.045
112604-060	● gris/gris	x1	30	450	560	550	3,60	mc. 0.045
112610-060	● chromé/cromado	x1	30	450	560	550	3,60	mc. 0.045

11 pack embouts d.25 tête sphérique
paquete tapones d.25 cabeza esférica

code	finishing	q.kit	q.pack
137003-075	● noir/negro	x4	120

12 moon-siège interne 4 pieds (habillable)
moon-asiento interno 4 patas (tapizable)

code	finishing	q.kit	q.pack	a	b	kg.x1	vol.x1
132203-063	● noir/negro	x1	10	490	470	1,90	mc. 0.011

for the components below, see previous page

04 05 06 07 09



magix



discover more about
Magix Collection

Une assise avec des accoudoirs structurels caractéristiques et confortables. Un châssis tubulaire en métal au design très particulier, prévu avec plusieurs finitions. Ce modèle est par ailleurs proposé avec plusieurs versions de dossiers : traditionnel, haut ou bas, à tapisser ou trapézoïdal à tapisser, en résille ou en pastique visible. Grâce à une large gamme de composants, aux deux types d'accoudoirs au choix et à deux options d'assise, Magix s'adapte sur un grand nombre de châssis en offrant un assortiment complet.

Magix est la solution parfaite pour une salle de conférence, une salle de meeting ou pour une réception accueillant le public.

El asiento con sus brazos estructurales, característicos y confortables. Una estructura de varilla metálica y con un diseño rigurosamente distintivo en varios acabados. También hay varias versiones disponibles para el respaldo: tradicional, alto o bajo, tapizable o trapezoidal tapizable, en malla o plástico sin tapizar. Con la gama vasta de componentes, dos tipos de brazos a elección y dos opciones para el asiento, Magix se adapta a un gran número de estructuras para ofrecer un surtido completo.

Magix es la solución ideal para el ambiente de los congresos, las salas de reunión o para los espacios de dirección.

Plus

- Une large gamme de composants proposés pour le dossier et l'assise.
- Extrêmement polyvalente et complète.
- Certification EN 16139:2013 de Niveau 1.
- Gama vasta de componentes para el respaldo y el asiento.
- Sumamente versátil y completa.
- Certificación EN 16139:2013 Nivel 1.



certified
product

magix

slide



CERTIFIED BY
CATAS

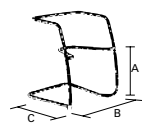
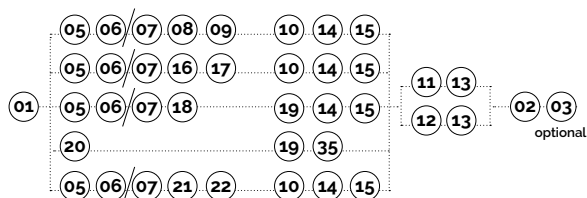
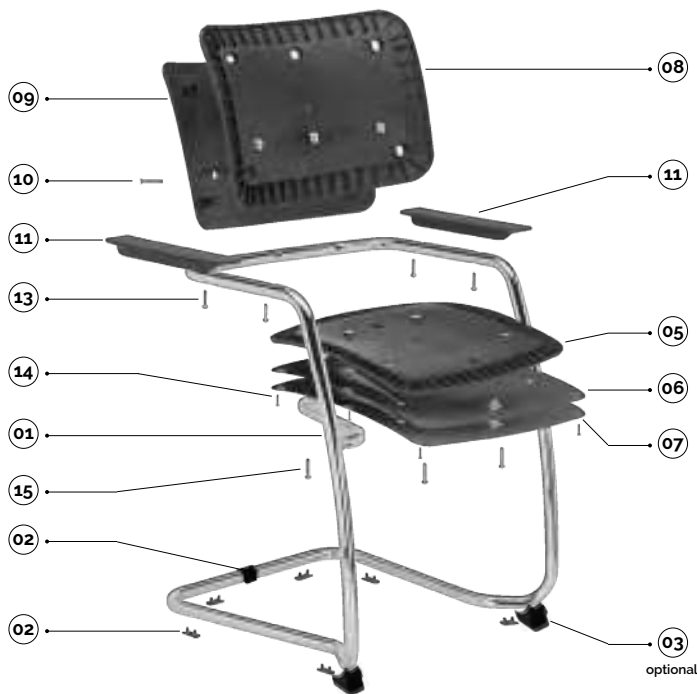

01

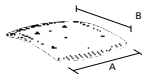

05



06



07

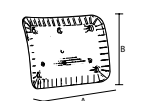

08

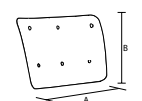

09

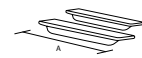

11



03



10

main component sizes

optionals

01 magix-base coulissante tube asform ø25 embouts exclus
magix-base patin tubular asform d. 25 tapones excluidos

code	finishing	q.kit	q.pack	a	b	c	kg.x1	vol.x1
110503-009	● noir/negro	x1	48	450	560	560	4,90	mc. 0,045
110504-112	● gris/gris	x1	24	450	560	560	4,90	mc. 0,045
110510-095	● chromé/cromado	x1	48	450	560	560	4,90	mc. 0,045

02 magix-paquet d'accessoires 50 picma + 290 p2pa
magix-bolsa de accesorios 50 picma + 290 p2pa

code	finishing	q.kit	q.pack	kg.x1	vol.x1
137000-009	● noir/negro	x1x6	50+290	1,00	mc. 0,1413

03 pied anticapotage en plastique noir
pie antivuelco de plástico negro

code	finishing	q.kit	q.pack	kg.x1	vol.x1
134303-006	● noir/negro	x2	100	0,025	mc. 0,0001

05 magix sdi-siège interne plastique noir
magix sdi-asiento interno de plástico negro

code	finishing	q.kit	q.pack	a	b	kg.x1	vol.x1
132203-035	● noir/negro	x1	10	480	460	1,10	mc. 0,045

06 magix sde-siège externe plastique noir
magix sde-asiento externo de plástico negro

code	finishing	q.kit	q.pack	a	b	kg.x1	vol.x1
132203-036	● noir/negro	x1	20	450	420	0,34	mc. 0,051

07 magix sde-siège externe en plastique noir pour châssis dessinant
magix sde-asiento externo de plástico negro para estructura patin

code	finishing	q.kit	q.pack	a	b	kg.x1	vol.x1
132203-037	● noir/negro	x1	20	450	420	0,436	mc. 0,051

08 magix shi-dossier interne en plastique
magix shi-respaldo interno de plástico

code	finishing	q.kit	q.pack	a	b	kg.x1	vol.x1
132103-040	● noir/negro	x1	20	470	290	0,95	mc. 0,004

09 magix she-dossier externe en plastique
magix she-respaldo externo de plástico

code	finishing	q.kit	q.pack	a	b	kg.x1	vol.x1
132103-041	● noir/negro	x1	20	470	290	0,26	mc. 0,055

11 paire d'accoudoirs droit-gauche plastique
pareja de brazos derecho-izquierdo de plástico

code	finishing	q.kit	q.pack	a	kg.x1	vol.x1
131703-040	● noir/negro	x2	100	200	0,04	mc. 0,0004

13 pack vis hilo tsp+ d.4x25 zinguée (pour fixer accoudoir)
paquete tornillo hi-lo tsp+ d.4x25 galvanizado (para fijar brazo)

code	finishing	q.kit	q.pack
117011-072	○ zinguée/galvanizado	x4	200

14 pack vis hilo tbl+ fr. 05x14 zinguée noire (pour fixer panneau assise)
paquete tornillo hi-lo tbl+ fr. d.5x14 galvanizado negro (para fijar panel asiento)

code	finishing	q.kit	q.pack
117003-071	● noir/negro	x6	200

15 vis tsp+m6x35 zinguée pour l'assise
tornillo tsp+m6x35 galvanizado para el asiento

code	finishing	q.kit
117711-183	○ zinguée/galvanizado	x4

10 vis tspcei m6x40
tornillo tspcei m6x40

code	finishing	q.kit
117711-250	○ zinguée/galvanizado	x3

magix

slide/armrest option

main component sizes

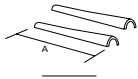

12



12 accouoir droit et gauche plastique conique
brazo derecho e izquierdo de plástico cónico

code	finishing	q.kit	q.pack	a	kg.x1	vol.x1
131703-041	● noir/negro	x2	200	205	0,04	mc. 0.0002

slide/backrest and seat options

main component sizes

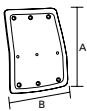

16



16 magix shi-dossier interne haut plastique noir
magix shi-respaldo interno alto de plástico negro

code	finishing	q.kit	q.pack	a	b	kg.x1	vol.x1
132103-043	● noir/negro	x1	20	540	450	1,80	mc. 0.0055

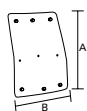

17

17 magix she-dossier externe haut plastique noir
magix she-respaldo externo alto de plástico negro

code	finishing	q.kit	q.pack	a	b	kg.x1	vol.x1
132103-042	● noir/negro	x1	20	540	450	0,50	mc. 0.0069

and · 10 14 15 13

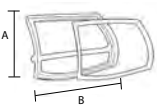

18



18 dossier et cadre pour treillis urban
respaldo y marco para malla urban

code	finishing	q.kit	q.pack	a	b	kg.x1	vol.x1
132103-037	● noir/negro	x1	10	288	453	0,98	mc. 0.015

19 vis tspcei m6x35
tornillo tspcei m6x35

code	finishing	q.kit
117711-180	○ zinguée/galvanizado	x3

and · 14 15 13

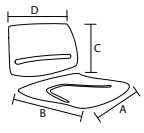

20



20 assise et dossier urban
asiento y respaldo base urban

Moq: 500pz/order

code	finishing	q.kit	q.pack	a	b	c	d	kg.x1	vol.x1
134003-112	● noir/negro	x1	10	452	425	288	453	2,5	mc. 0.016
134004-112	● gris/gris	x1	10	452	425	288	453	2,5	mc. 0.016
134005-112	○ blanc/blanco	x1	10	452	425	288	453	2,5	mc. 0.016

19 vis tspcei m6x35
tornillo tspcei m6x35

code	finishing	q.kit
117711-180	○ zinguée/galvanizado	x3

35 vis autoperceuse ts* 5,5x38 zinguée
tornillo autoroscante ts* 5,5x38 galvanizado

code	finishing	q.kit
117811-165	○ zinguée/galvanizado	x4

and · 13

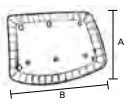

21



21 dossier interne urban
respaldo interno urban

code	finishing	q.kit	q.pack	a	b	kg.x1	vol.x1
132103-039	● noir/negro	x1	20	450	540	0,77	mc. 0.006

22 dossier externe urban
respaldo externo urban

code	finishing	q.kit	q.pack	a	b	kg.x1	vol.x1
132103-038	● noir/negro	x1	20	450	540	0,24	mc. 0.006

and · 10 14 15 13

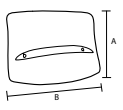

22

magix

4-legs

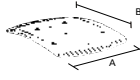
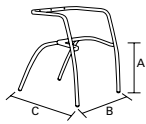
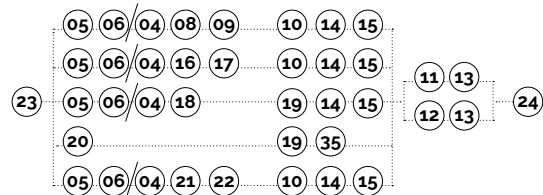
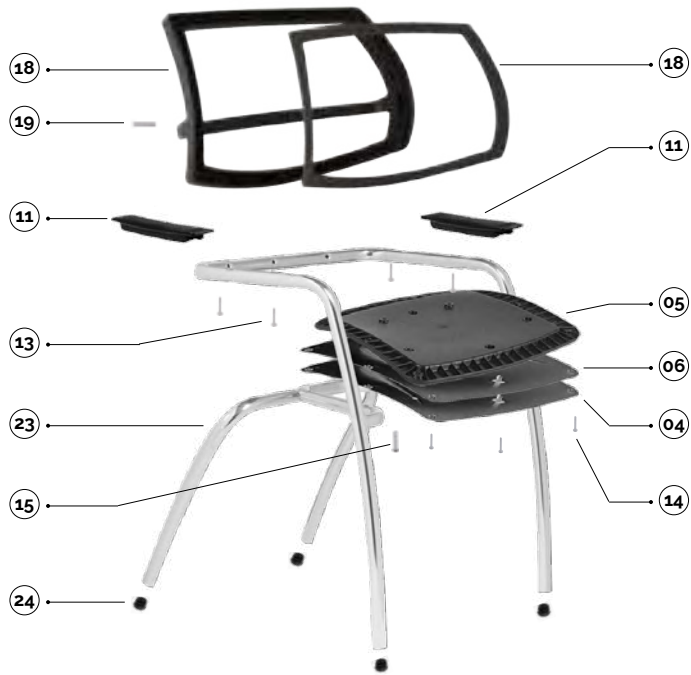

23

05



06

04

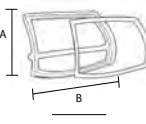

18

11

main component sizes

23 magix-châssis 4 pieds tube d.25 sans embouts
magix-estructura 4 patas tubular d. 25 sin tapones

code	finishing	q.kit	q.pack	a	b	c	kg.x1	vol.x1
110103-006	● noir/negro	x1	30	450	550	550	4.10	mc. 0.045
110104-006	● gris/gris	x1	30	450	550	550	4.10	mc. 0.045
110110-006	● chromé/cromado	x1	30	450	550	550	4.10	mc. 0.045

24 pack embout d.25 tête sphérique
paquete tapón d.25 cabeza esférica

code	finishing	q.kit	q.pack
137003-075	● noir/negro	x4	120

05 magix sdi-siège interne plastique noir
magix sdi-asiento interno de plástico negro

code	finishing	q.kit	q.pack	a	b	kg.x1	vol.x1
132203-035	● noir/negro	x1	10	480	460	1.10	mc. 0.045

06 magix sde-siège externe plastique noir
magix sde-asiento externo de plástico negro

code	finishing	q.kit	q.pack	a	b	kg.x1	vol.x1
132203-036	● noir/negro	x1	20	450	420	0.34	mc. 0.051

04 magix sde-siège externe plastique noir pour châssis 4 pieds
magix sde-asiento externo de plástico negro para estructura 4 patas

code	finishing	q.kit	q.pack	a	b	kg.x1	vol.x1
132203-038	● noir/negro	x1	20	450	420	0.452	mc. 0.051

18 dossier et cadre pour treillis urban
respaldo y marco para malla urban

code	finishing	q.kit	q.pack	a	b	kg.x1	vol.x1
132103-037	● noir/negro	x1	10	288	453	0.98	mc. 0.015

11 paire d'accoudoirs droit-gauche plastique
pareja de brazos derecho-izquierdo de plástico

code	finishing	q.kit	q.pack	a	kg.x1	vol.x1
131703-040	● noir/negro	x2	100	200	0.04	mc. 0.0004

13 pack vis hilo tsp+ d.4x25 zinguée (pour fixer accoudoir)
paquete tornillo hi-lo tsp+ d.4x25 galvanizado (para fijar brazo)

code	finishing	q.kit	q.pack
117011-072	○ zinguée/galvanizado	x4	200

14 pack vis hilo tbl+ fr. 05x14 zinguée noire (pour fixer panneau assise)
paquete tornillo hi-lo tbl+ fr. d.5x14 galvanizado negro (para fijar panel asiento)

code	finishing	q.kit	q.pack
117003-071	● noir/negro	x6	200

15 vis tsp+m6x35 zinguée pour l'assise
tornillo tsp+m6x35 galvanizado para el asiento

code	finishing	q.kit
117711-183	○ zinguée/galvanizado	x4

19 vis tspcei m6x35
tornillo tspcei m6x35

code	finishing	q.kit
117711-180	○ zinguée/galvanizado	x3

magix

4-legs/armrest option

main component sizes

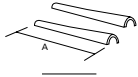

12



12 accouoir droit et gauche plastique conique
brazo derecho e izquierdo de plástico cónico

code	finishing	q.kit	q.pack	a	kg.x1	vol.x1
131703-041	● noir/negro	x2	200	205	0,04	mc. 0.0002

4-legs/backrest and seat options

main component sizes

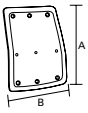

16



16 magix shi-dossier interne haut plastique noir
magix shi-respaldo interno alto de plástico negro

code	finishing	q.kit	q.pack	a	b	kg.x1	vol.x1
132103-043	● noir/negro	x1	20	540	450	1,80	mc. 0.0055

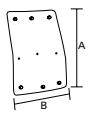

17

17 magix she-dossier externe haut plastique noir
magix she-respaldo externo alto de plástico negro

code	finishing	q.kit	q.pack	a	b	kg.x1	vol.x1
132103-042	● noir/negro	x1	20	540	450	0,50	mc. 0.0069

and · **10** **14** **15** **13**

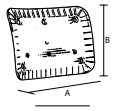

08



08 magix shi-dossier interne en plastique
magix shi-respaldo interno de plástico

code	finishing	q.kit	q.pack	a	b	kg.x1	vol.x1
132103-040	● noir/negro	x1	20	470	290	0,95	mc. 0.004

09 magix she-dossier externe en plastique
magix she-respaldo externo de plástico

code	finishing	q.kit	q.pack	a	b	kg.x1	vol.x1
132103-041	● noir/negro	x1	20	470	290	0,26	mc. 0.055

and · **10** **14** **15** **13**

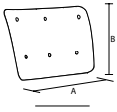

09

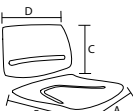

20



20 assise et dossier urban
asiento y respaldo base urban

code	finishing	q.kit	q.pack	a	b	c	d	kg.x1	vol.x1
134003-112	● noir/negro	x1	10	452	425	288	453	2,5	mc. 0.016
134004-112	● gris/gris	x1	10	452	425	288	453	2,5	mc. 0.016
134005-112	○ blanc/blanco	x1	10	452	425	288	453	2,5	mc. 0.016

and · **19** **35** **13**

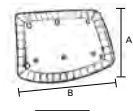

21



21 dossier interne urban
respaldo interno urban

code	finishing	q.kit	q.pack	a	b	kg.x1	vol.x1
132103-039	● noir/negro	x1	20	450	540	0,77	mc. 0.006

22 dossier externe urban
respaldo externo urban

code	finishing	q.kit	q.pack	a	b	kg.x1	vol.x1
132103-038	● noir/negro	x1	20	450	540	0,24	mc. 0.006

and · **10** **14** **15** **13**

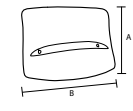

22

magix

4-legs for castors

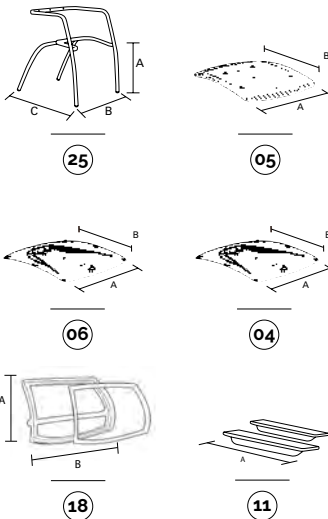
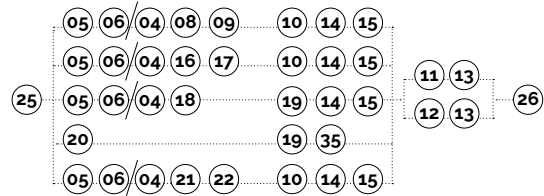
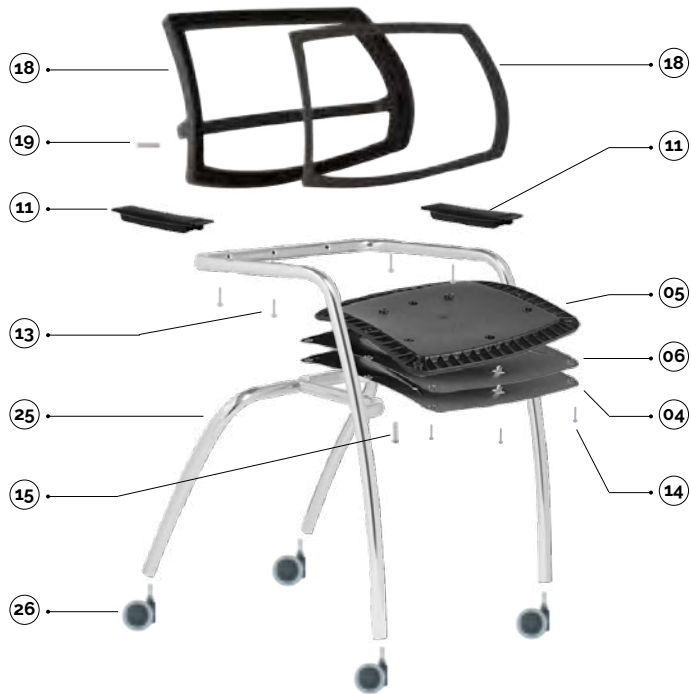

main component sizes

25 magix-châssis quatre pieds ø25 avec adaptateurs pour roulettes

code	finishing	q.kit	q.pack	a	b	c	kg.x1	vol.x1
110103-005	● noir/negro	x1	30	450	550	550	3,90	mc. 0,045
110104-005	● gris/gris	x1	30	450	550	550	3,90	mc. 0,045
110110-005	● chromé/cromado	x1	30	450	550	550	3,90	mc. 0,045

26 double roulette d.50 en desmopan tige montée

code	finishing	q.kit
134403-003	● noir/negro	x4

05 magix sdi-siège interne plastique noir

code	finishing	q.kit	q.pack	a	b	kg.x1	vol.x1
132203-035	● noir/negro	x1	10	480	460	1,10	mc. 0,045

06 magix sde-siège externe plastique noir

code	finishing	q.kit	q.pack	a	b	kg.x1	vol.x1
132203-036	● noir/negro	x1	20	450	420	0,34	mc. 0,051

04 magix sde-siège externe plastique noir pour châssis 4 pieds

code	finishing	q.kit	q.pack	a	b	kg.x1	vol.x1
132203-038	● noir/negro	x1	20	450	420	0,452	mc. 0,051

18 dossier et cadre pour treillis urban

code	finishing	q.kit	q.pack	a	b	kg.x1	vol.x1
132103-037	● noir/negro	x1	10	288	453	0,98	mc. 0,015

11 paire d'accoudoirs droit-gauche plastique

code	finishing	q.kit	q.pack	a	kg.x1	vol.x1
131703-040	● noir/negro	x2	100	200	0,04	mc. 0,0004

13 pack vis hilo tsp+ d.4x25 zinguée (pour fixer accoudoir)

code	finishing	q.kit	q.pack
117011-072	○ zinguée/galvanizado	x4	200

14 pack vis hilo tbl+ fr. 05x14 zinguée noire (pour fixer panneau assise)

code	finishing	q.kit	q.pack
117003-071	● noir/negro	x6	200

15 vis tsp+m6x35 zinguée pour l'assise

code	finishing	q.kit
117711-183	○ zinguée/galvanizado	x4

19 vis tspcei m6x35

code	finishing	q.kit
117711-180	○ zinguée/galvanizado	x3

magix

4-legs for castors/armrest option

main component sizes

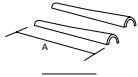

12



12 accouoir droit et gauche plastique conique
brazo derecho e izquierdo de plástico cónico

code	finishing	q.kit	q.pack	a	kg.x1	vol.x1
131703-041	● noir/negro	x2	200	205	0,04	mc. 0.0002

4-legs for castors/backrest and seat options

main component sizes

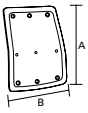

16



16 magix shi-dossier interne haut plastique noir
magix shi-respaldo interno alto de plástico negro

code	finishing	q.kit	q.pack	a	b	kg.x1	vol.x1
132103-043	● noir/negro	x1	20	540	450	1,80	mc. 0.0055

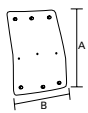

17



17 magix she-dossier externe haut plastique noir
magix she-respaldo externo alto de plástico negro

code	finishing	q.kit	q.pack	a	b	kg.x1	vol.x1
132103-042	● noir/negro	x1	20	540	450	0,50	mc. 0.0069

and · **10** **14** **15** **13**

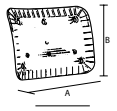

08



08 magix shi-dossier interne en plastique
magix shi-respaldo interno de plástico

code	finishing	q.kit	q.pack	a	b	kg.x1	vol.x1
132103-040	● noir/negro	x1	20	470	290	0,95	mc. 0.004

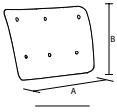

09



09 magix she-dossier externe en plastique
magix she-respaldo externo de plástico

code	finishing	q.kit	q.pack	a	b	kg.x1	vol.x1
132103-041	● noir/negro	x1	20	470	290	0,26	mc. 0.055

and · **10** **14** **15** **13**

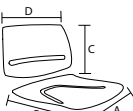

20



20 assise et dossier urban
asiento y respaldo base urban

code	finishing	q.kit	q.pack	a	b	c	d	kg.x1	vol.x1
134003-112	● noir/negro	x1	10	452	425	288	453	2,5	mc. 0.016
134004-112	● gris/gris	x1	10	452	425	288	453	2,5	mc. 0.016
134005-112	○ blanc/blanco	x1	10	452	425	288	453	2,5	mc. 0.016

and · **19** **35** **13**

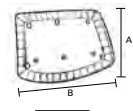

21



21 dossier interne urban
respaldo interno urban

code	finishing	q.kit	q.pack	a	b	kg.x1	vol.x1
132103-039	● noir/negro	x1	20	450	540	0,77	mc. 0.006

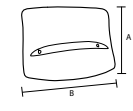

22



22 dossier externe urban
respaldo externo urban

code	finishing	q.kit	q.pack	a	b	kg.x1	vol.x1
132103-038	● noir/negro	x1	20	450	540	0,24	mc. 0.006

and · **10** **14** **15** **13**

magix

swivel

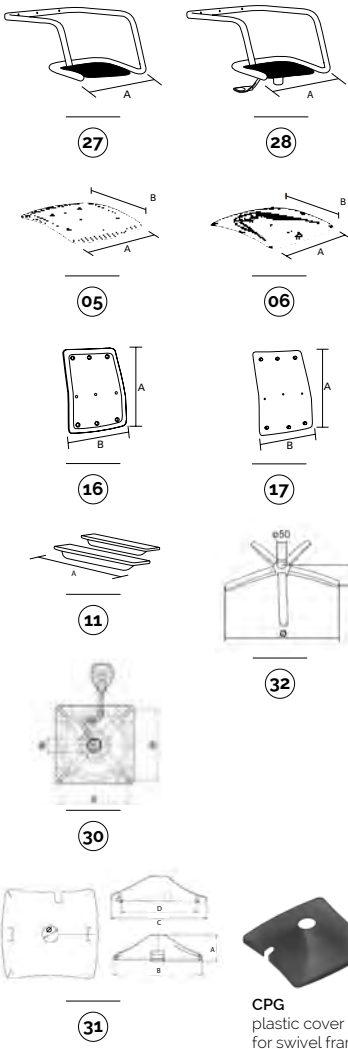
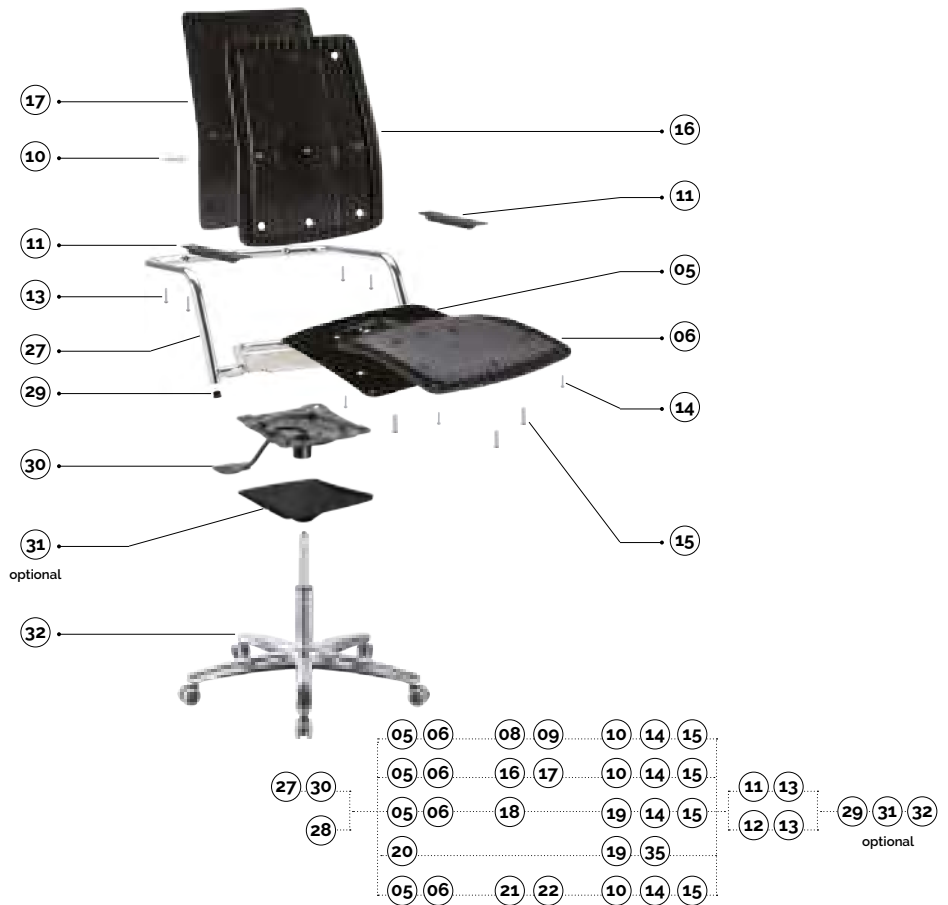

main component sizes

optionals

CPG
plastic cover
for swivel frame

27 magix-châssis pivotant d.25 avec accoudoirs sans embouts
magix-estructura versión giratoria d.25 con brazos sin tapones

code	finishing	q.kit	q.pack	a	kg.x1	vol.x1
110910-034	● chromé/cromado	x1	50	550	5,00	mc. 0.045
110903-034	● noir/negro	x1	50	550	5,00	mc. 0.045

28 magix(01)gc-châssis pivotant d.25 avec accoudoirs sans embouts + spatule
magix(01)gc-estructura version giratoria d.25 con brazos sin tapones + palanca

code	finishing	q.kit	q.pack	a	kg.x1	vol.x1
110910-033	● chromé/cromado	x1	50	550	5,00	mc. 0.045
110903-037	● noir/negro	x1	50	550	5,00	mc. 0.045

05 magix sdi-siège interne plastique noir
magix sdi-asiento interno de plástico negro

code	finishing	q.kit	q.pack	a	b	kg.x1	vol.x1
132203-035	● noir/negro	x1	10	480	460	1,10	mc. 0.045

06 magix sde-siège externe plastique noir
magix sde-asiento externo de plástico negro

code	finishing	q.kit	q.pack	a	b	kg.x1	vol.x1
132203-036	● noir/negro	x1	20	450	420	0,34	mc. 0.051

16 magix shi-dossier interne haut plastique noir
magix shi-respaldo interno alto de plástico negro

code	finishing	q.kit	q.pack	a	b	kg.x1	vol.x1
132103-043	● noir/negro	x1	20	540	450	1,80	mc. 0.0055

17 magix she-dossier externe haut plastique noir
magix she-respaldo externo alto de plástico negro

code	finishing	q.kit	q.pack	a	b	kg.x1	vol.x1
132103-042	● noir/negro	x1	20	540	450	0,50	mc. 0.0069

10 vis tspcei m6x40
tornillo tspcei m6x40

code	finishing	q.kit	q.pack	a	b	kg.x1	vol.x1
117711-250	○ zinguée/galvanizado	x3					

11 paire d'accoudoirs droit-gauche plastique
pareja de brazos derecho-izquierdo de plástico

code	finishing	q.kit	q.pack	a	kg.x1	vol.x1
131703-040	● noir/negro	x2	100	200	0,04	mc. 0.0004

13 pack vis hilo tsp* d.4x25 zinguée (pour fixer accoudoir)
paquete tornillo hi-lo tsp* d.4x25 galvanizado (para fijar brazo)

code	finishing	q.kit	q.pack	a	kg.x1	vol.x1
117011-072	○ zinguée/galvanizado	x4	200			

30 pss28nr-plaque tabouret avec levier c/28 3" l4 noire
pss28nr- placa taburete con palanca c/28 3" l4 negra

code	finishing	q.kit	q.pack	a	b	ø	kg.x1	vol.x1
113003-104	● noir/negro	x1	25	150	150	28	1,23	mc. 0.002

31 cpg-couverture en plastique pour châssis pivotant
cpg-cubierta de plástico para estructura versión giratoria

code	finishing	q.kit	q.pack	a	b	c	d	ø	kg.x1	vol.x1
130903-000	● noir/negro	x1	50	60	200	210	167	36	0,1	mc. 0.0015

32 b40-base en métal avec cache-soudure
b40-base de metal con embellecedor soldadura

code	finishing	q.kit	q.pack	a	ø	kg.x1	vol.x1
110210-027	● chromé/cromado	x1	5	60	640	2,85	mc. 0.014

14 pack vis hilo tbl* fr. 05x14 zinguée noire
paquete tornillo hi-lo tbl* fr. d.5x14 galvanizado negro

code	finishing	q.kit	q.pack	a	kg.x1	vol.x1
117003-071	● noir/negro	x6	200			

29 embouts couvre-tête ronds d.25 noir
tacos redondos con aletas d.18 negro

code	finishing	q.kit	q.pack	a	kg.x1	vol.x1
134103-250	● noir/negro	x2				

15 vis tsp*m6x35 zinguée pour l'assise
tornillo tsp*m6x35 galvanizado para el asiento

code	finishing	q.kit	q.pack	a	kg.x1	vol.x1
117711-183	○ zinguée/galvanizado	x4				

magix

swivel/armrest option

main component sizes

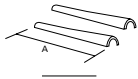

12



12 accouoir droit et gauche plastique conique
brazo derecho e izquierdo de plástico cónico

code	finishing	q.kit	q.pack	a	kg.x1	vol.x1
131703-041	● noir/negro	x2	200	205	0,04	mc. 0.0002

swivel/backrest and seat options

main component sizes

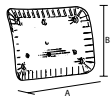

08



08 magix shi-dossier interne en plastique
magix shi-respaldo interno de plástico

code	finishing	q.kit	q.pack	a	b	kg.x1	vol.x1
132103-040	● noir/negro	x1	20	470	290	0,95	mc. 0.004

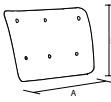

09

09 magix she-dossier externe en plastique
magix she-respaldo externo de plástico

code	finishing	q.kit	q.pack	a	b	kg.x1	vol.x1
132103-041	● noir/negro	x1	20	470	290	0,26	mc. 0.055

and - **10** **14** **15** **13**

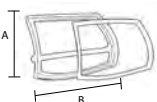

18



18 dossier et cadre pour treillis urban
respaldo y marco para malla urban

code	finishing	q.kit	q.pack	a	b	kg.x1	vol.x1
132103-037	● noir/negro	x1	10	288	453	0,98	mc. 0.015

19 vis tspcei m6x35
tornillo tspcei m6x35

code	finishing	q.kit
117711-180	○ zinguée/galvanizado	x3

and - **14** **15** **13**

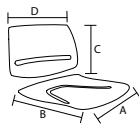

20



20 assise et dossier urban
asiento y respaldo base urban

code	finishing	q.kit	q.pack	a	b	c	d	kg.x1	vol.x1
134003-112	● noir/negro	x1	10	452	425	288	453	2,5	mc. 0.016
134004-112	● gris/gris	x1	10	452	425	288	453	2,5	mc. 0.016
134005-112	○ blanc/blanco	x1	10	452	425	288	453	2,5	mc. 0.016

19 vis tspcei m6x35
tornillo tspcei m6x35

code	finishing	q.kit
117711-180	○ zinguée/galvanizado	x3

and - **35** **13**

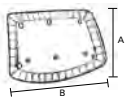

21



21 dossier interne urban
respaldo interno urban

code	finishing	q.kit	q.pack	a	b	kg.x1	vol.x1
132103-039	● noir/negro	x1	20	450	540	0,77	mc. 0.006

22 dossier externe urban
respaldo externo urban

code	finishing	q.kit	q.pack	a	b	kg.x1	vol.x1
132103-038	● noir/negro	x1	20	450	540	0,24	mc. 0.006

and - **10** **14** **15** **13**

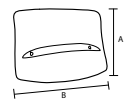

22

magix

bench

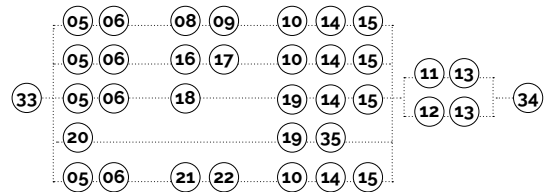

33 magix-structure pour banquette d.25 avec accoudoirs sans embouts magix-estructura para bancada d.25 con brazos sin tapones

code	finishing	q.kit	q.pack	a	kg.x1	vol.x1
110710-200	● chromé/cromado	x1	60	550	5,00	mc. 0,045

20 assise et dossier urban asiento y respaldo base urban

code	finishing	q.kit	q.pack	a	b	c	d	kg.x1	vol.x1
134003-112	● noir/negro	x1	10	452	425	288	453	2,5	mc. 0,016
134004-112	● gris/gris	x1	10	452	425	288	453	2,5	mc. 0,016
134005-112	○ blanc/blanco	x1	10	452	425	288	453	2,5	mc. 0,016

19 vis tspcei m6x35 tornillo tspcei m6x35

code	finishing	q.kit
117711-180	○ zinguée/galvanizado	x3

12 accoudoir droit et gauche plastique conique brazo derecho e izquierdo de plástico cónico

code	finishing	q.kit	q.pack	a	kg.x1	vol.x1
131703-041	● noir/negro	x2	200	205	0,04	mc. 0,0002

13 pack vis hilo tsp+ d.4x25 zinguée (pour fixer accoudoir) paquete tornillo hi-lo tsp+ d.4x25 galvanizado (para fijar brazo)

code	finishing	q.kit	q.pack
117011-072	○ zinguée/galvanizado	x4	200

35 vis auto-perceuse ts+ 5,5x38 zinguée tornillo autoroscante ts+ 5,5x38 galvanizado

code	finishing	q.kit
117811-165	○ zinguée/galvanizado	x4

29 embouts couvre-tête ronds d.25 noir tacos redondos con aletas d.18 negro

code	finishing	q.kit
134103-250	● noir/negro	x2

34 got(03) poutre pour banquette 80x40 got(03) viga para bancada 80x40

code	finishing	places	q.kit	q.pack	a	b	c	kg.x1	vol.x1
110703-190	● noir/negro	2 places / 2 asientos	x1	1	1160	80	40	3,20	mc. 0,0045
110704-190	● gris/gris	2 places / 2 asientos	x1	1	1160	80	40	3,20	mc. 0,0045
110703-191	● noir/negro	3 places / 3 asientos	x1	1	1710	80	40	4,71	mc. 0,005
110704-191	● gris/gris	3 places / 3 asientos	x1	1	1710	80	40	4,71	mc. 0,005
110703-192	● noir/negro	4 places / 4 asientos	x1	1	2260	80	40	6,22	mc. 0,0085
110704-192	● gris/gris	4 places / 4 asientos	x1	1	2260	80	40	6,22	mc. 0,0085
110703-193	● noir/negro	5 places / 5 asientos	x1	1	2800	80	40	7,72	mc. 0,01
110704-197	● gris/gris	5 places / 5 asientos	x1	1	2800	80	40	7,72	mc. 0,01

for the bench components, see page 417

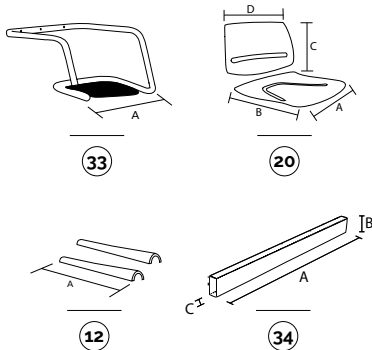

main component sizes



OPTIONAL
bench connector

E-USB
bench plug

JIM
bench leg

90GM
bench leg

90GF
bench leg

91GM **NEW**
bench leg

100GM
bench leg

200GM
bench leg

PIONEER
bench arm

CUT
bench leg

SLIM
bench leg

CUT
bench arm

SLIM
bench arm

plastic

metal

aluminium

optionals

magix

bench/armrest option

main component sizes

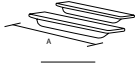

11



11 paire d'accoudoirs droit-gauche plastique
pareja de brazos derecho-izquierdo de plástico

code	finishing	q.kit	q.pack	a	kg.x1	vol.x1
131703-040	● noir/negro	x2	100	200	0,04	mc. 0.0004

bench/backrest and seat options

main component sizes

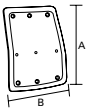

16



16 magix shi-dossier interne haut plastique noir
magix shi-respaldo interno alto de plástico negro

code	finishing	q.kit	q.pack	a	b	kg.x1	vol.x1
132103-043	● noir/negro	x1	20	540	450	1,80	mc. 0.0055

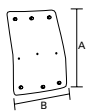

17

17 magix she-dossier externe haut plastique noir
magix she-respaldo externo alto de plástico negro

code	finishing	q.kit	q.pack	a	b	kg.x1	vol.x1
132103-042	● noir/negro	x1	20	540	450	0,50	mc. 0.0069

and · **10** **14** **15** **13**

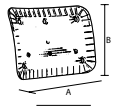

08



08 magix shi-dossier interne en plastique
magix shi-respaldo interno de plástico

code	finishing	q.kit	q.pack	a	b	kg.x1	vol.x1
132103-040	● noir/negro	x1	20	470	290	0,95	mc. 0.004

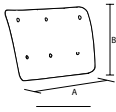

09

09 magix she-dossier externe en plastique
magix she-respaldo externo de plástico

code	finishing	q.kit	q.pack	a	b	kg.x1	vol.x1
132103-041	● noir/negro	x1	20	470	290	0,26	mc. 0.055

and · **10** **14** **15** **13**

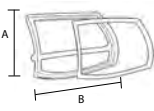

18



18 dossier et cadre pour treillis urban
respaldo y marco para malla urban

code	finishing	q.kit	q.pack	a	b	kg.x1	vol.x1
132103-037	● noir/negro	x1	10	288	453	0,98	mc. 0.015

and · **19** **14** **15** **13**

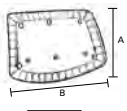

21



21 dossier interne urban
respaldo interno urban

code	finishing	q.kit	q.pack	a	b	kg.x1	vol.x1
132103-039	● noir/negro	x1	20	450	540	0,77	mc. 0.006

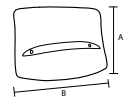

22

22 dossier externe urban
respaldo externo urban

code	finishing	q.kit	q.pack	a	b	kg.x1	vol.x1
132103-038	● noir/negro	x1	20	450	540	0,24	mc. 0.006

and · **10** **14** **15** **13**



young / key / fabric



discover more about
Young Collection



discover more about
Key Collection



discover more about
Fabric Collection

Young, Key et Fabric, les nouvelles coques en bois multicouche de hêtre. Trois coques au design caractéristique avec un trou central, en T ou à tapisser, toutes compatibles avec les châssis de la famille Magix, offrant un grand nombre de combinaisons.

Young, Key e Fabric sont idéales pour les bureaux.

Young, Key y Fabric, las nuevas carcasas realizadas en madera contrachapada de haya. Tres carcasas con un diseño distintivo, un orificio central, en T o tapizables y todas ellas compatibles con las estructuras de la familia Magix, que regalan lo máximo en cuanto a combinaciones.

Young, Key and Fabric son ideales para el ambiente de la oficina.

Plus

- Une coque en bois multicouche de hêtre.
- La coque visible est proposée dans 5 couleurs.
- Une ligne ergonomique.
- Une grande polyvalence.
- La version à tapisser offre une finition unique en son genre.
- *Carcasa en madera contrachapada de haya.*
- *5 colores disponibles para la carcasa sin tapizar.*
- *Línea ergonómica.*
- *Máxima versatilidad.*
- *La versión tapizable permite un acabado único.*

young slide

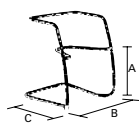
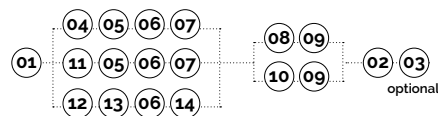

01

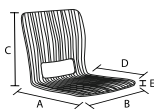

02

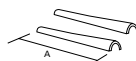

03

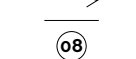

04

01 magix-base coulissante tube asform ø25 embouts exclus
magix-base patin tubular asform d. 25 tapones excluidos

code	finishing	q.kit	q.pack	a	b	c	kg.x1	vol.x1
110503-009	● noir/negro	x1	48	450	560	560	4,90	mc. 0,045
110504-112	● gris/gris	x1	48	450	560	560	4,90	mc. 0,045
110510-095	● chromé/cromado	x1	48	450	560	560	4,90	mc. 0,045

02 magix-paquet d'accessoires 50 picma + 290 p2pa
magix-bolsa de accesorios 50 picma + 290 p2pa

code	finishing	q.kit	q.pack	kg.x1	vol.x1
137000-009	● noir/negro	x1+x6	50+290	1,00	mc. 0,1413

03 pied anticapotage en plastique noir
pie antivuelco de plástico negro

code	finishing	q.kit	q.pack	kg.x1	vol.x1
134303-006	● noir/negro	x2	100	0,025	mc. 0,0001

04 magix/young-monocoque multicouche hêtre avec inserts
magix/young-monocarcasa multicapa de haya con insertos

code	finishing	q.kit	q.pack	a	b	c	d	e	kg.x1	vol.x1
122107-015	● hêtre/haya	x1	5	556	487	396	396	11	3,11	mc. 0,0312
122115-015	● bleu clair/azul claro	x1	5	556	487	396	396	11	3,11	mc. 0,0312
122116-015	● vert/verde	x1	5	556	487	396	396	11	3,11	mc. 0,0312
122104-015	● bleu-gris/gris azulado	x1	5	556	487	396	396	11	3,11	mc. 0,0312
122107-021	● orange/naranja	x1	5	556	487	396	396	11	3,11	mc. 0,0312

05 vis 4.8 tsp+ m6x30 zinguée pour l'assise
tornillo 4.8 tsp+ m6x30 galvanizada para el asiento

code	finishing	q.kit
117711-192	○ zinguée/galvanizado	x4

06 support dossier coque en bois
soporte para respaldo carcasa de madera

code	finishing	q.kit	q.pack	kg.x1	vol.x1
132103-077	● noir/negro	x1	100	0,26	mc. 0,055
132105-077	○ ivoire/marfil ral1013	x1	100	0,26	mc. 0,055

07 vis tspei m5x40 zinguée blanche pour dossier
tornillo tspei m5x40 galvanizado blanco para respaldo

code	finishing	q.kit
117711-154	○ zinguée blanc/galvanizado blanco	x3

08 accoudoir droit et gauche plastique conique
brazo derecho e izquierdo de plástico cónico

code	finishing	q.kit	q.pack	a	kg.x1	vol.x1
131703-041	● noir/negro	x2	200	205	0,04	mc. 0,0002
131703-042	○ ivoire/marfil ral1013	x2	200	205	0,04	mc. 0,0002

09 pack vis hilo tsp+ d.4x25 zinguée (pour fixer accoudoir)
paquete tornillo hi-lo tsp+ d.4x25 galvanizado (para fijar brazo)

code	finishing	q.kit	q.pack
117011-072	○ zinguée/galvanizado	x4	200

main component sizes

optionals



03



young

slide/armrest option

main component sizes

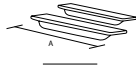

10



- 10 paire d'accoudoirs droit-gauche plastique
pareja de brazos derecho-izquierdo de plástico

code	finishing	q.kit	q.pack	a	kg.x1	vol.x1
131703-040	● noir/negro	x2	100	200	0,04	mc. 0.0004

slide/shell options

main component sizes

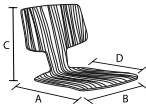

11



- 11 magix/key-monocoque multicouche hêtre avec inserts
magix/key-monocarcasa multicapa de haya con insertos

code	finishing	q.kit	q.pack	a	b	c	d	kg.x1	vol.x1
122107-016	● hêtre/haya	x1	5	552	483	398	391	2,76	mc. 0.0312
122115-016	● bleu clair/azul claro	x1	5	552	483	398	391	2,76	mc. 0.0312
122116-016	● vert/verde	x1	5	552	483	398	391	2,76	mc. 0.0312
122104-016	● bleu-gris/gris azulado	x1	5	552	483	398	391	2,76	mc. 0.0312
122107-022	● orange/naranja	x1	5	552	483	398	391	2,76	mc. 0.0312

and 05 07

spessore 11mm
thickness 11mm

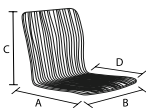

12



- 12 magix/fabric-monocoque multicouche hêtre pour tapisserie avec inserts
magix/fabric-monocarcasa multicapa de haya para tapizar con insertos

code	finishing	q.kit	q.pack	a	b	c	d	kg.x1	vol.x1
122107-017	● hêtre/haya	x1	5	556	487	396	396	3,50	mc. 0.0312

- 13 vis 4.8 tsp+ m6x35 zinguée blanche pour l'assise
tornillo 4.8 tsp+ m6x35 galvanizado blanco para el asiento

code	finishing	q.kit
117711-183	● zinguée blanc/galvanizado blanco	x4

- 14 vis tspei m5x45 zinguée blanche pour dossier
tornillo tspei m5x45 galvanizado blanco para el respaldo

code	finishing	q.kit
117711-156	● zinguée blanc/galvanizado blanco	x3

spessore 11mm
thickness 11mm

key

4-legs

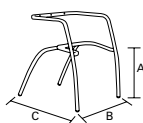
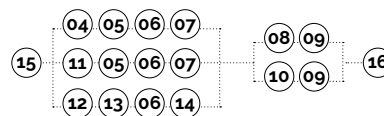
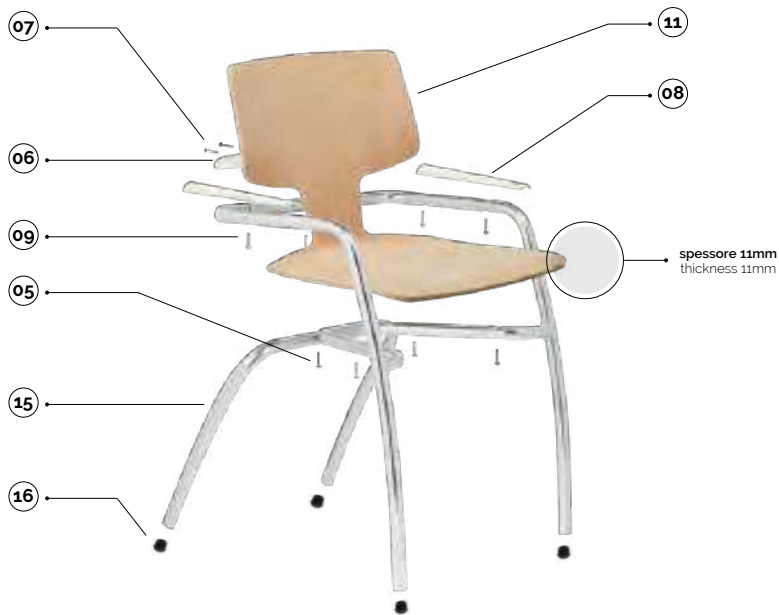

15

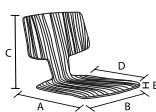

11

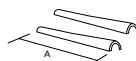

08

15 magix-châssis 4 pieds tube d.25 sans embouts
magix-estructura 4 patas tubular d. 25 sin tapones

code	finishing	q.kit	q.pack	a	b	c	kg.x1	vol.x1
110103-006	● noir/negro	x1	30	450	550	550	4.10	mc. 0.045
110104-006	● gris/gris	x1	30	450	550	550	4.10	mc. 0.045
110110-006	● chromé/cromado	x1	30	450	550	550	4.10	mc. 0.045

16 pack embout d.25 tête sphérique
paquete tapón d.25 cabeza esférica

code	finishing	q.kit	q.pack
137003-075	● noir/negro	x4	120

11 magix/key-monocoque multicouche hêtre avec inserts
magix/key-monocarcasa multicapa de haya con insertos

code	finishing	q.kit	q.pack	a	b	c	d	e	kg.x1	vol.x1
122107-016	● hêtre/haya	x1	5	552	483	398	391	11	2,76	mc. 0.0312
122115-016	● bleu clair/azul claro	x1	5	552	483	398	391	11	2,76	mc. 0.0312
122116-016	● vert/verde	x1	5	552	483	398	391	11	2,76	mc. 0.0312
122104-016	● bleu-gris/gris azulado	x1	5	552	483	398	391	11	2,76	mc. 0.0312
122107-022	● orange/naranja	x1	5	552	483	398	391	11	2,76	mc. 0.0312

05 vis 4.8 tsp+ m6x30 zinguée pour l'assise
tornillo 4.8 tsp+ m6x30 galvanizada para el asiento

code	finishing	q.kit
117711-192	○ zinguée/galvanizado	x4

06 support dossier coque en bois
soporte para respaldo carcasa de madera

code	finishing	q.kit	q.pack	kg.x1	vol.x1
132103-077	● noir/negro	x1	100	0,26	mc. 0.055
132105-077	○ ivoire/marfil rat1013	x1	100	0,26	mc. 0.055

07 vis tspei m5x40 zinguée blanche pour dossier
tornillo tspei m5x40 galvanizado blanco para respaldo

code	finishing	q.kit
117711-154	○ zinguée blanc/galvanizado blanco	x3

08 accoudoir droit et gauche plastique conique
brazo derecho e izquierdo de plástico cónico

code	finishing	q.kit	q.pack	a	kg.x1	vol.x1
131703-041	● noir/negro	x2	200	205	0,04	mc. 0.0002
131703-042	○ ivoire/marfil rat1013	x2	200	205	0,04	mc. 0.0002

09 pack vis hilo tsp+ d.4x25 zinguée (pour fixer accoudoir)
paquete tornillo hi-lo tsp+ d.4x25 galvanizado (para fijar brazo)

code	finishing	q.kit	q.pack
117011-072	○ zinguée/galvanizado	x4	200

key

4-legs/armrest option

main component sizes

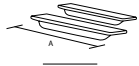

10

10 paire d'accoudoirs droit-gauche plastique
pareja de brazos derecho-izquierdo de plástico

code	finishing	q.kit	q.pack	a	kg.x1	vol.x1
131703-040	● noir/negro	x2	100	200	0,04	mc. 0.0004

4-legs/shell options

main component sizes

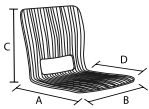

04



spessore 11mm
thickness 11mm

04 magix/young-monocoque multicouche hêtre avec inserts
magix/young-monocarcasa multicapa de haya con insertos

code	finishing	q.kit	q.pack	a	b	c	d	kg.x1	vol.x1
122107-015	● hêtre/haya	x1	5	556	487	396	396	3,11	mc. 0.0312
122115-015	● bleu clair/azul claro	x1	5	556	487	396	396	3,11	mc. 0.0312
122116-015	● vert/verde	x1	5	556	487	396	396	3,11	mc. 0.0312
122104-015	● bleu-gris/gris azulado	x1	5	556	487	396	396	3,11	mc. 0.0312
122107-021	● orange/naranja	x1	5	556	487	396	396	3,11	mc. 0.0312

and **05** **07**

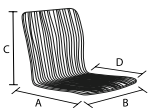

12



spessore 11mm
thickness 11mm

12 magix/fabric-monocoque multicouche hêtre pour tapisserie avec inserts
magix/fabric-monocarcasa multicapa de haya para tapizar con insertos

code	finishing	q.kit	q.pack	a	b	c	d	kg.x1	vol.x1
122107-017	● hêtre/haya	x1	5	556	487	396	396	3,50	mc. 0.0312

13 vis 4.8 tsp+ m6x35 zinguée blanche pour l'assise
tornillo 4.8 tsp+ m6x35 galvanizado blanco para el asiento

code	finishing	q.kit
117711-183	● zinguée blanc/galvanizado blanco	x4

14 vis tspei m5x45 zinguée blanche pour dossier
tornillo tspei m5x45 galvanizado blanco para el respaldo

code	finishing	q.kit
117711-156	● zinguée blanc/galvanizado blanco	x3

key

4-legs for castors

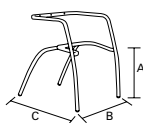
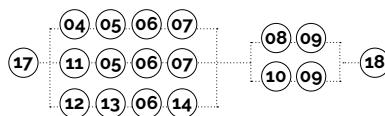

17

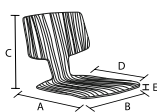

11

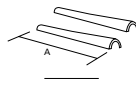

08

main component sizes

17 magix-châssis quatre pieds ø25 avec adaptateurs pour roulettes
magix-estructura cuatro patas d. 25 con adaptadores para ruedas

code	finishing	q.kit	q.pack	a	b	c	kg.x1	vol.x1
110103-005	● noir/negro	x1	30	450	550	550	3,90	mc. 0,045
110104-005	● gris/gris	x1	30	450	550	550	3,90	mc. 0,045
110110-005	● chromé/cromado	x1	30	450	550	550	3,90	mc. 0,045

18 double roulette d.50 en desmopan tige montée
rueda doble d.50 de desmopan con perno montado

code	finishing	q.kit
134403-003	● noir/negro	x4

11 magix/key-monocoque multicouche hêtre avec inserts
magix/key-monocarcasa multicapa de haya con insertos

code	finishing	q.kit	q.pack	a	b	c	d	e	kg.x1	vol.x1
122107-016	● hêtre/haya	x1	5	552	483	398	391	11	2,76	mc. 0,0312
122115-016	● bleu clair/azul claro	x1	5	552	483	398	391	11	2,76	mc. 0,0312
122116-016	● vert/verde	x1	5	552	483	398	391	11	2,76	mc. 0,0312
122104-016	● bleu-gris/gris azulado	x1	5	552	483	398	391	11	2,76	mc. 0,0312
122107-022	● orange/naranja	x1	5	552	483	398	391	11	2,76	mc. 0,0312

05 vis 4.8 tsp+ m6x30 zinguée pour l'assise
tornillo 4.8 tsp+ m6x30 galvanizada para el asiento

code	finishing	q.kit
117711-192	○ zinguée/galvanizado	x4

06 support dossier coque en bois
soporte para respaldo carcasa de madera

code	finishing	q.kit	q.pack	kg.x1	vol.x1
132103-077	● noir/negro	x1	100	0,26	mc. 0,055
132105-077	○ ivoire/marfil ral1013	x1	100	0,26	mc. 0,055

07 vis tpe m5x40 zinguée blanche pour dossier
tornillo tpe m5x40 galvanizado blanco para respaldo

code	finishing	q.kit
117711-154	○ zinguée blanc/galvanizado blanco	x3

08 accoudoir droit et gauche plastique conique
brazo derecho e izquierdo de plástico cónico

code	finishing	q.kit	q.pack	a	kg.x1	vol.x1
131703-041	● noir/negro	x2	200	205	0,04	mc. 0,0002
131703-042	○ ivoire/marfil ral1013	x2	200	205	0,04	mc. 0,0002

09 pack vis hilo tsp+ d.4x25 zinguée (pour fixer accoudoir)
paquete tornillo hi-lo tsp+ d.4x25 galvanizado (para fijar brazo)

code	finishing	q.kit	q.pack
117011-072	○ zinguée/galvanizado	x4	200

key

4-legs/armrest option

main component sizes

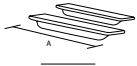

10



10 paire d'accoudoirs droit-gauche plastique
pareja de brazos derecho-izquierdo de plástico

code	finishing	q.kit	q.pack	a	kg.x1	vol.x1
131703-040	● noir/negro	x2	100	200	0,04	mc. 0.0004

4-legs/shell options

main component sizes

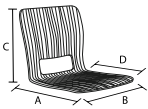

04



spessore 11mm
thickness 11mm

04 magix/young-monocoque multicouche hêtre avec inserts
magix/young-monocarcasa multicapa de haya con insertos

code	finishing	q.kit	q.pack	a	b	c	d	kg.x1	vol.x1
122107-015	● hêtre/haya	x1	5	556	487	396	396	3,11	mc. 0.0312
122115-015	● bleu clair/azul claro	x1	5	556	487	396	396	3,11	mc. 0.0312
122116-015	● vert/verde	x1	5	556	487	396	396	3,11	mc. 0.0312
122104-015	● bleu-gris/gris azulado	x1	5	556	487	396	396	3,11	mc. 0.0312
122107-021	● orange/naranja	x1	5	556	487	396	396	3,11	mc. 0.0312

and **05** **07**

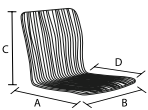

12



spessore 11mm
thickness 11mm

12 magix/fabric-monocoque multicouche hêtre pour tapisserie avec inserts
magix/fabric-monocarcasa multicapa de haya para tapizar con insertos

code	finishing	q.kit	q.pack	a	b	c	d	kg.x1	vol.x1
122107-017	● hêtre/haya	x1	5	556	487	396	396	3,50	mc. 0.0312

13 vis 4.8 tsp+ m6x35 zinguée blanche pour l'assise
tornillo 4.8 tsp+ m6x35 galvanizado blanco para el asiento

code	finishing	q.kit
117711-183	● zinguée blanc/galvanizado blanco	x4

14 vis tspei m5x45 zinguée blanche pour dossier
tornillo tspei m5x45 galvanizado blanco para el respaldo

code	finishing	q.kit
117711-156	● zinguée blanc/galvanizado blanco	x3

fabric

swivel

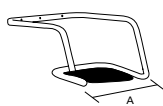
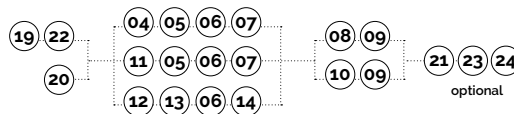

19

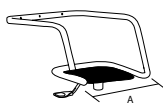

20

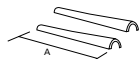

08

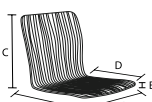

12

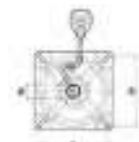

22

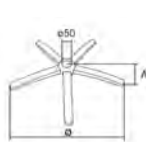

24

main component sizes

optionals

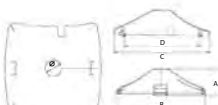

23

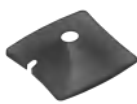

CPG
plastic cover
for swivel frame

19 magix-châssis pivotant d.25 avec accoudoirs sans embouts magix-estructura versión giratoria d.25 con brazos sin tapones

code	finishing	q.kit	q.pack	a	kg.x1	vol.x1
110910-034	● chromé/cromado	x1	50	550	5,00	mc. 0.045

20 magix(01)gc-châssis pivotant d.25 avec accoudoirs sans embouts + spatule magix(01)gc-estructura versión giratoria d.25 con brazos sin tapones + palanca

code	finishing	q.kit
110910-033	● chromé/cromado	x1 50 550

21 embouts couvre-tête ronds d.25 noir tacos redondos con aletas d.18 negro

code	finishing	q.kit
134103-250	● noir/negro	x2

12 magix/fabric-monocoque multicouche hêtre pour tapisserie avec inserts magix/fabric-monocarcasa multicapa de haya para tapizar con insertos

code	finishing	q.kit	q.pack	a	b	c	d	e	kg.x1	vol.x1
122107-017	● hêtre/haya	x1	5	556	487	396	396	11	3,50	mc. 0.0312

13 vis 4.8 tsp+ m6x35 zinguée blanche pour l'assise tornillo 4.8 tsp+ m6x35 galvanizado blanco para el asiento

code	finishing	q.kit
117711-183	○ zinguée blanc/galvanizado blanco	x4

14 vis tpei m5x45 zinguée blanche pour dossier tornillo tpei m5x45 galvanizado blanco para el respaldo

code	finishing	q.kit
117711-156	○ zinguée blanc/galvanizado blanco	x3

06 support dossier coque en bois soporte para respaldo carcasa de madera

code	finishing	q.kit	q.pack	kg.x1	vol.x1
132103-077	● noir/negro	x1	100	0,26	mc. 0.055
132105-077	○ ivoire/marfil ral1013	x1	100	0,26	mc. 0.055

08 accoudoir droit et gauche plastique conique brazo derecho e izquierdo de plástico conico

code	finishing	q.kit	q.pack	a	kg.x1	vol.x1
131703-041	● noir/negro	x2	200	205	0,04	mc. 0.0002
131703-042	○ ivoire/marfil ral1013	x2	200	205	0,04	mc. 0.0002

09 pack vis hilo tsp+ d.4x25 zinguée (pour fixer accoudoir) paquete tornillo hi-lo tsp+ d.4x25 galvanizado (para fijar brazo)

code	finishing	q.kit	q.pack
117011-072	○ zinguée/galvanizado	x4	200

22 pss28nr-plaque tabouret avec levier c/28 3' l4 noire pss28nr- placa taburete con palanca c/28 3' l4 negra

code	finishing	q.kit	q.pack	a	b	ø	kg.x1	vol.x1
113003-104	● noir/negro	x1	25	150	150	28	1,23	mc. 0.002

23 cpg-couverture en plastique pour châssis pivotant cpg-cubierta de plástico para estructura versión giratoria

code	finishing	q.kit	q.pack	a	b	c	d	ø	kg.x1	vol.x1
130903-000	● noir/negro	x1	50	60	200	210	167	36	0,1	mc. 0.0015

24 b40-base en métal avec cache-soudure b40-base de metal con embellecedor soldadura

code	finishing	q.kit	q.pack	a	ø	kg.x1	vol.x1
110210-027	● chromé/cromado	x1	5	60	640	2,85	mc. 0.014

young / key / fabric

bench

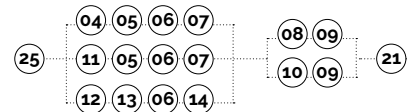

25 magix-structure pour banquette d.25 avec accoudoirs sans embouts
magix-estructura para bancada d.25 con brazos sin tapones

code	finishing	q.kit	q.pack	a	kg.x1	vol.x1
110710-200	● chromé/cromado	x1	60	550	5,00	mc. 0,045

26 got(03) poutre pour banquette 80x40
got(03) viga para bancada 80x40

code	finishing	q.kit	q.pack	a	b	c	kg.x1	vol.x1
110703-190	● noir/negro	x1	1	1160	80	40	3,20	mc. 0,0045
110704-190	● gris/gris	x1	1	1160	80	40	3,20	mc. 0,0045
110703-191	● noir/negro	x1	1	1710	80	40	4,71	mc. 0,005
110704-191	● gris/gris	x1	1	1710	80	40	4,71	mc. 0,005
110703-192	● noir/negro	x1	1	2260	80	40	6,22	mc. 0,0085
110704-192	● gris/gris	x1	1	2260	80	40	6,22	mc. 0,0085
110703-193	● noir/negro	x1	1	2800	80	40	7,72	mc. 0,01
110704-197	● gris/gris	x1	1	2800	80	40	7,72	mc. 0,01

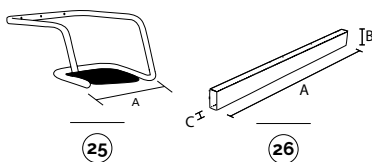

for the components below, see previous pages

for the components below, see previous pages

04 05 06 07 08 09

11

for the components below, see previous pages

for the bench components, see page 417

12 13 14 21

main component sizes

bench/armrest option

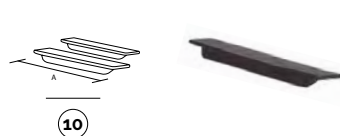

10 paire d'accoudoirs droit-gauche plastique
pareja de brazos derecho-izquierdo de plástico

code	finishing	q.kit	q.pack	a	kg.x1	vol.x1
131703-040	● noir/negro	x2	100	200	0,04	mc. 0,0004

optionals

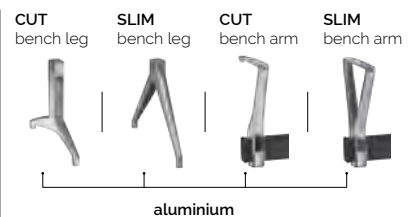



flash



discover more about
Flash Collection

Une assise au design moderne et géométrique que l'on remarque au premier coup d'oeil sans pour autant renoncer au confort.

Son dossier portant en plastique peut être associé à un châssis avec une base traîneau ou quatre pieds.

Flash a été conçue pour l'aménagement d'une réception.

Un asiento de diseño moderno y geométrico, que impacta a primera vista sin renunciar al confort.

El respaldo portante de plástico puede montarse en una estructura con base de patín o de cuatro patas.

Flash está pensado para una utilización front office.

flash

slide

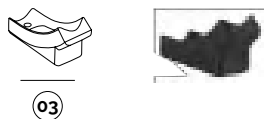
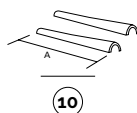
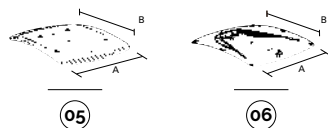
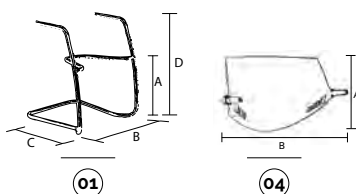
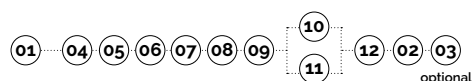
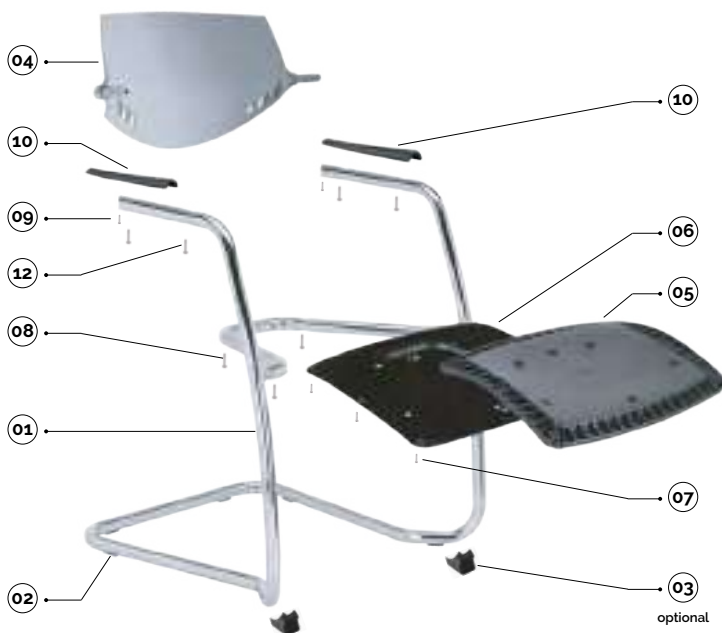

01 flash-base coulissante tube d.25 embouts exclus
flash-base patin tubular d. 25 tapones excluidos

code	finishing	q.kit	q.pack	a	b	c	d	kg.x1	vol.x1
110503-071	● noir/negro	x1	36	450	560	560	830	5,00	mc. 0.045
110504-071	● gris/gris	x1	36	450	560	560	830	5,00	mc. 0.045
110510-071	● chromé/cromado	x1	36	450	560	560	830	5,00	mc. 0.045

02 pince deux broches en polyéthylène noire
pinza dos ganchos de polietileno negra

code	finishing	q.kit
134003-003	● noir/negro	x6

03 pied anticapotage en plastique noir
pie antivuelco de plástico negro

code	finishing	q.kit	q.pack	kg.x1	vol.x1
134303-006	● noir/negro	x2	100	0,025	mc. 0.0001

04 flash-dossier plastique
flash-respaldo de plástico

code	finishing	q.kit	q.pack	a	b	kg.x1	vol.x1
132103-070	● noir/negro	x1	10	300	480	0,90	mc. 0.01
132104-070	● gris/gris	x1	10	300	480	0,90	mc. 0.01

05 flash-siège interne en plastique noir
flash-asiento interno de plástico negro

code	finishing	q.kit	q.pack	a	b	kg.x1	vol.x1
132203-035	● noir/negro	x1	10	480	460	1,10	mc. 0.045

06 flash-siège externe en plastique noir
flash-asiento externo de plástico negro

code	finishing	q.kit	q.pack	a	b	kg.x1	vol.x1
132203-036	● noir/negro	x1	20	450	420	0,34	mc. 0.051

07 pack vis tbl+ fr. d.5x14 brun noir
paquete de tornillos tbl+ fr. d.5x14 bruñido negro

code	finishing	q.kit	q.pack
117003-071	● noir/negro	x6	200

08 vis 4.8tsp+ m6x35 zinguée
tornillos 4.8tsp+ m6x35 galvanizada

code	finishing	q.kit
117711-183	○ zinguée/galvanizado	x4

09 vis médium tsp+ d.4x20 zinguée (pour fixation dossier)
tornillo para panel de aglomerado tsp+ d.4x20 galvanizado (para fijación respaldo)

code	finishing	q.kit
117811-121	○ zinguée/galvanizado	x2

10 accoudoir droit et gauche plastique conique
brazo derecho e izquierdo de plástico cónico

code	finishing	q.kit	q.pack	a	kg.x1	vol.x1
131703-041	● noir/negro	x2	200	205	0,04	mc. 0.0002

12 pack vis médium tsp+ d.4x25 zinguée (pour fixation accoudoir)
paquete tornillo para panel de aglomerado tsp+ d.4x25 galvanizado (para fijación brazo)

code	finishing	q.kit	q.pack
117011-072	○ zinguée/galvanizado	x4	200

main component sizes

optionals

flash

4-legs

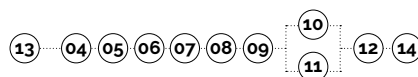
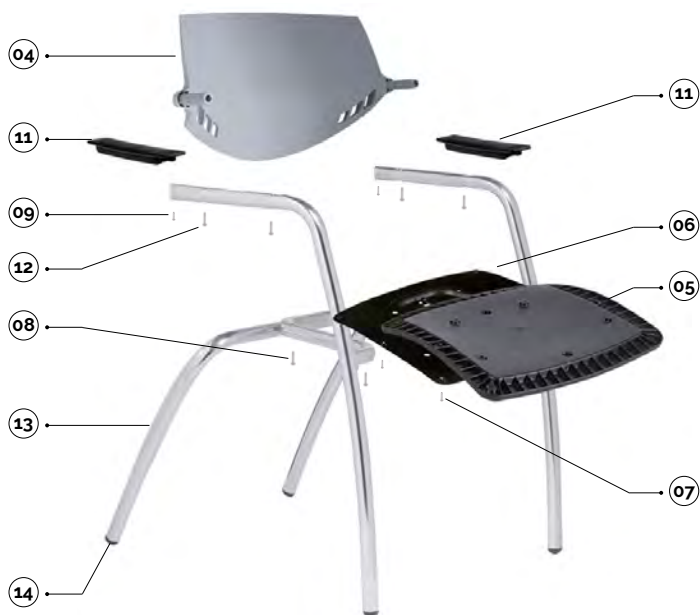

main component sizes

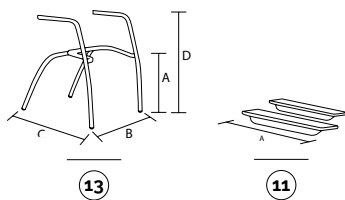

13 flash-châssis 4 pieds avec accoudoirs tube ø25 embouts exclus
flash-estructura 4 patas con brazos tubular d. 25 tapones excluidos

code	finishing	q.kit	q.pack	a	b	c	d	kg.x1	vol.x1
110103-040	● noir/negro	x1	30	450	550	570	830	3,60	mc. 0.045
110104-040	● gris/gris	x1	30	450	550	570	830	3,60	mc. 0.045
110110-040	● chromé/cromado	x1	30	450	550	570	830	3,60	mc. 0.045

14 pack embouts tête sphérique d.25
paquete de tacos con cabeza esférica d.25

code	finishing	q.kit	q.pack
137003-075	● noir/negro	x4	120

11 accoudoir droit et gauche plastique noir
brazo derecho e izquierdo de plástico negro

code	finishing	q.kit	q.pack	a	kg.x1	vol.x1
131703-040	● noir/negro	x2	100	200	0,04	mc. 0.0004

for the components below, see previous page

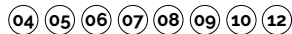

optionals

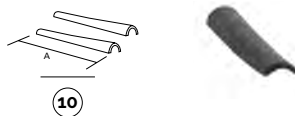

flash

swivel

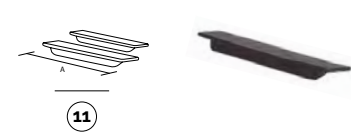
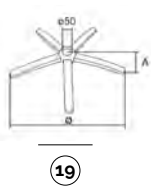
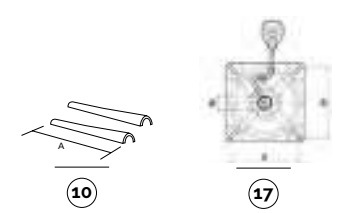
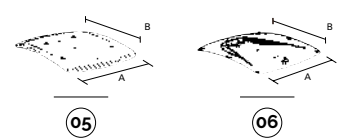
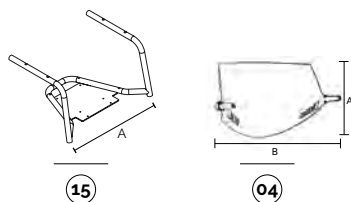
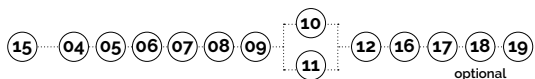
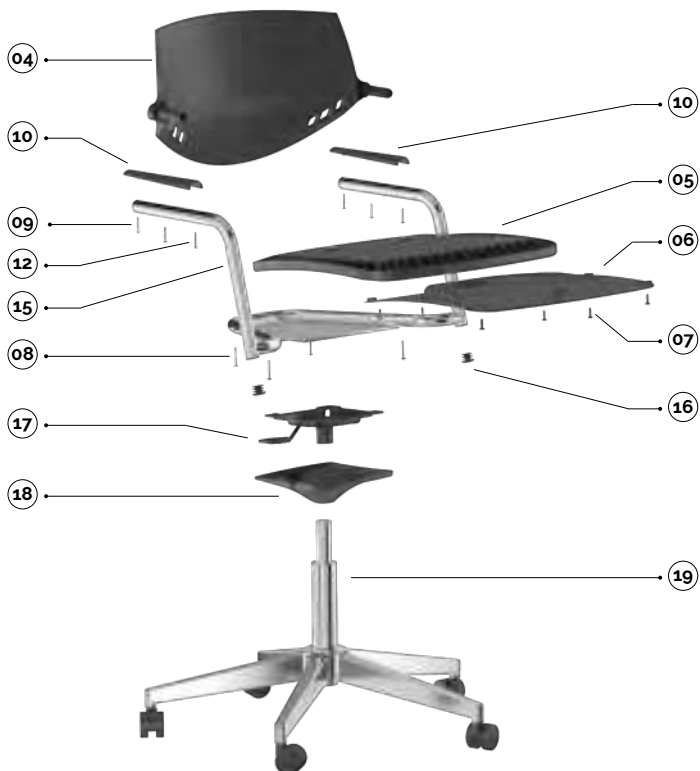

15 flash - châssis pivotant Ø25 avec accoudoirs sans embouts
flash - estructura giratoria Ø25 con reposabrazos sin tapones

code	finishing	q.kit	q.pack	a
110910-302	● chromé/cromado	x1	50	550

16 flash - embout à ailettes en plastique Ø25
flash - Ø25 tapón de cabeza de plástico con aletas

code	finishing	q.kit
134103-250	● noir/negro	x2

17 pss28nr-plaque pour tabouret avec spatule cône Ø28 3° L4
pss28nr- placa de taburete negra c/palanca cono Ø28 3° L4

code	finishing	q.kit	q.pack	a	b	ø	kg.x1	vol.x1
113003-104	● noir/negro	x1	25	150	150	28	1.23	mc. 0.002

18 cpg-couvercle en plastique pour structure pivotante
cpg-cubierta de plástico para base giratoria

code	finishing	q.kit	q.pack	a	b	c	d	ø	kg.x1	vol.x1
130903-000	● noir/negro	x1	50	60	200	210	167	36	0.1	mc. 0.0015

19 b40 base métallique Ø640 avec couvercle soudé
b40 base metálica Ø640 con tapa de soldadura

code	finishing	q.kit	q.pack	a	ø	kg.x1	vol.x1
110210-027	● chromé/cromado	x1	5	60	640	2.85	mc. 0.014

for the components below, see previous pages

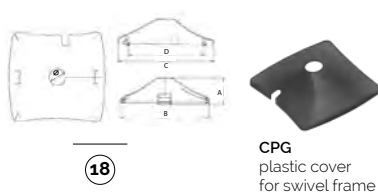

CPG
plastic cover
for swivel frame

main component sizes

optionals





q9



discover more about
Q9 Collection

Le concept de sa monocoque est innovant, avec une forme particulière et des dimensions généreuses.

Cette assise a été conçue pour aménager de manière essentielle et personnalisée une réception ou une salle de réunion.

Elle est disponible avec un panneau à tapisser ou avec un cadre pour dossier en résille. Elle est donc parfaite pour tout type d'environnement.

Un concepto innovador de monocarcasa, con un diseño distintivo y dimensiones amplias.

Creada para decorar con importancia y gran carácter el front office y las salas de reunión.

Disponibile con paneles tapizables y con marco para respaldo de malla, es perfecta en todas las situaciones.

q9

slide

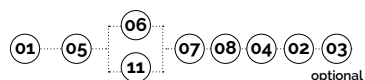

main component sizes

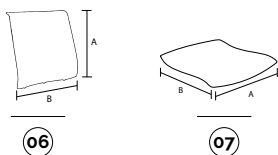
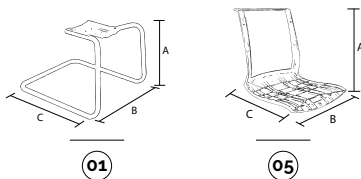

optionals

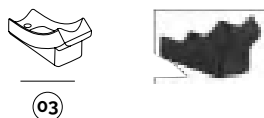

01 q9-châssis coulissant en tube ø25 sans embouts

q9-estructura patin tubular d. 25 sin tapones

code	finishing	q.kit	q.pack	a	b	c	kg.x1	vol.x1
110503-131	● noir/negro	x1	64	400	560	550	4,10	mc. 0.032
110504-131	● gris/gris	x1	64	400	560	550	4,10	mc. 0.032
110510-111	● chromé/cromado	x1	64	400	560	550	4,10	mc. 0.032

02 p2p-pince deux broches en plastique

p2p-pinza dos ganchos plástico

code	finishing	q.kit
134003-003	● noir/negro	x6

03 pied anticapotage en plastique noir

pie antivuelco de plástico negro

code	finishing	q.kit	q.pack	kg.x1	vol.x1
134303-006	● noir/negro	x2	100	0,025	mc. 0.0001

04 embouts couvre-tête d.25

tapones embellecedores d.25

code	finishing	q.kit
134110-250	● chromé/cromado	x2
134103-250	● noir/negro	x2

05 q9-coque mono en plastique+pack

q9-monocarcasa de plástico + paquete

code	finishing	q.kit	q.pack	a	b	c	kg.x1	vol.x1
133903-007	● noir/negro	x1	5	550	480	480	3,20	mc. 0.021
133905-007	○ blanc/blanco	x1	5	550	480	480	3,20	mc. 0.021

06 q9-panneau dossier en plastique à revêtir

q9-galleta respaldo de plástico tapizable

code	finishing	q.kit	q.pack	a	b	kg.x1	vol.x1
132103-061	● noir/negro	x1	10	460	460	1,30	mc. 0.01
132105-012	○ blanc/blanco	x1	10	460	460	1,30	mc. 0.01

07 q9-panneau siège à revêtir en plastique

q9-galleta asiento tapizable de plástico

code	finishing	q.kit	q.pack	a	b	kg.x1	vol.x1
132203-040	● noir/negro	x1	10	480	480	0,80	mc. 0.009

08 vis tête cylindrique croix m6x16 zinguée (pour fixer la coque)

tornillo cabeza cilíndrica en cruz m6x16 galvanizado (para fijar carcasa)

code	finishing	q.kit
117711-191	○ zinguée/galvanizado	x4

q9

slide w/armrests

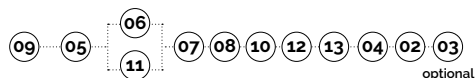

main component sizes

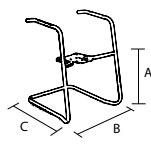

09

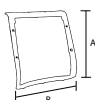

11



12

optionals



03



09 qg-châssis coulissant avec accoudoirs en tube d.25 pour coque sans embouts
qg-estructura patin con brazos tubular d.25 para carcasa sin tapones

code	finishing	q.kit	q.pack	a	b	c	kg.x1	vol.x1
110503-095	● noir/negro	x1	36	400	560	550	5,60	mc. 0.045
110504-132	● gris/gris	x1	36	400	560	550	5,60	mc. 0.045
110510-132	● chromé/cromado	x1	36	400	560	550	5,60	mc. 0.045

10 embout couvre-tête d.25 chromé
tapón embellecedor d.25 cromado

code	finishing	q.kit
134110-250	● chromé/cromado	x2

11 cadre dossier en plastique pour treillis
qg-marco respaldo de plástico para malla

code	finishing	q.kit	q.pack	a	b	kg.x1	vol.x1
132103-060	● noir/negro	x1	20	460	460	0,52	mc. 0.007
132105-011	○ blanc/blanco	x1	20	460	460	0,52	mc. 0.007

12 qg-accoudoir droit et gauche plastique conique
qg-brazo derecho e izquierdo de plástico cónico

code	finishing	q.kit	q.pack	a	kg.x1	vol.x1
131703-041	● noir/negro	x2	200	205	0,04	mc. 0.0002

13 pack vis hilo tsp+ d.4x25 zinguée (pour fixer accoudoir)
paquete tornillo hi-lo tsp+ d.4x25 galvanizado (para fijar brazo)

code	finishing	q.kit	q.pack
117011-072	○ zinguée/galvanizado	x4	200

for the components below, see previous page

02 03 04 05 07 08

q9 bench

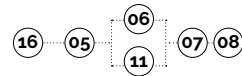

main component sizes

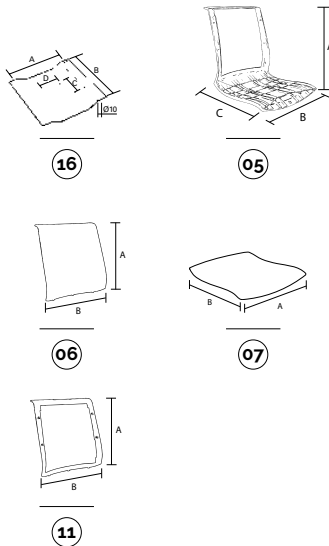

16 92p(01)-plaque de raccordement coque et banquette 92p(01)-placa para enganche carcasa en bancada

code	finishing	q.kit	q.pack	a	b	c	d	kg.x1	vol.x1
110703-013	● noir/negro	x1	25	153	200	65	55	0,85	mc. 0002

05 q9-coque mono en plastique + pack q9-monocarcasa de plástico + paquete

code	finishing	q.kit	q.pack	a	b	c	kg.x1	vol.x1
133903-007	● noir/negro	x1	5	550	480	480	3,20	mc. 0.021
133905-007	○ blanc/blanco	x1	5	550	480	480	3,20	mc. 0.021

06 q9-panneau dossier en plastique à revêtir q9-galleta respaldo de plástico tapizable

code	finishing	q.kit	q.pack	a	b	kg.x1	vol.x1
132103-061	● noir/negro	x1	10	460	460	1,30	mc. 0.01
132105-012	○ blanc/blanco	x1	10	460	460	1,30	mc. 0.01

11 q9-cadre dossier en plastique pour treillis q9-marco respaldo de plástico para malla

code	finishing	q.kit	q.pack	a	b	kg.x1	vol.x1
132103-060	● noir/negro	x1	20	460	460	0,52	mc. 0.007
132105-011	○ blanc/blanco	x1	20	460	460	0,52	mc. 0.007

07 q9-panneau siège à revêtir en plastique q9-galleta asiento tapizable de plástico

code	finishing	q.kit	q.pack	a	b	kg.x1	vol.x1
132203-040	● noir/negro	x1	10	480	480	0,80	mc. 0.009

08 vis tête cylindrique croix m6x16 zinguée (pour fixer la coque) tornillo cabeza cilíndrica en cruz m6x16 galvanizado (para fijar carcasa)

code	finishing	q.kit
117711-191	○ zinguée/galvanizado	x4

for the bench components, see page 417

optionals

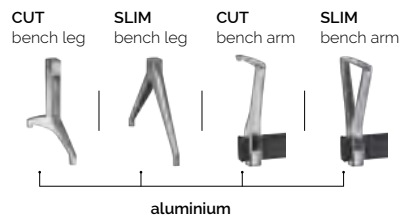
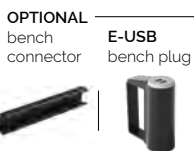





square



discover more about
Square Collection

Une chaise polyvalente et caractéristique. Large et confortable, fonctionnelle pour plusieurs utilisations. Square est prévue avec un dossier et une assise possédant des variantes intéressantes: à tapisser, en plastique visible, avec petits panneaux à tapisser, en multicouche de hêtre peint. Grâce aux nombreuses options et versions de châssis proposées, il est adaptée pour de multiples utilisations.

Square est parfaite dans un bureau ou un milieu professionnel.

Una silla versátil y con carácter. Amplia y confortable, funcional en varios usos, tiene un respaldo y un asiento en variantes interesantes: tapizables, en plástico visible, con posibles galletas tapizables, en contrachapado de haya para pintar. Con su número elevado de opciones y versiones de estructuras disponibles, Square se adapta a múltiples utilidades.

Square resulta indicada para el ambiente de la oficina y el ambiente del contract.

Plus

- Châssis avec une section du tube rectangulaire, une caractéristique de ce modèle sur le marché.
- Une assise ample et confortable.
- Une polyvalence optimale.
- Une qualité certifiée CATAS.
- Certification EN 16139:2013+AC:2013 de Niveau 1.
- Certification ANSI/BIFMA X5.1.
- Estructura con sección de varilla rectangular, que la distingue en el mercado.
- Asiento amplio y confortable.
- Máxima versatilidad.
- Calidad certificada CATAS.
- Certificación EN 16139:2013+AC:2013 Nivel 1.
- Certificación ANSI/ BIFMA X5.1.



designed by:
R&D Alba



**trolley
available**



**certified
product**

square

4-legs



CERTIFIED BY
**BIFMA
CATAS**

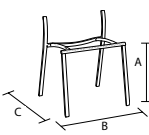
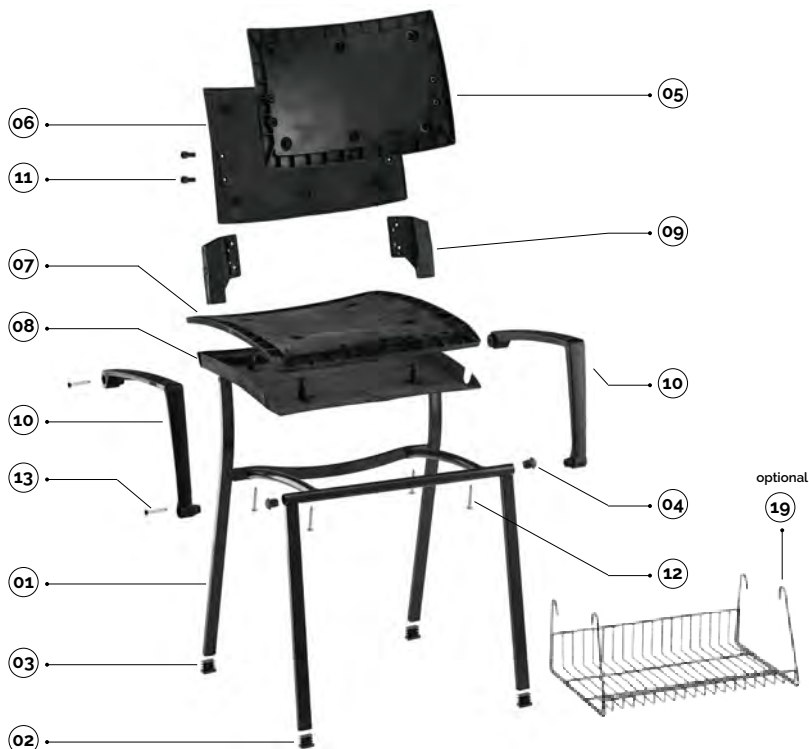

01

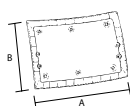

05

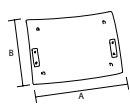

06

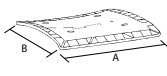

07

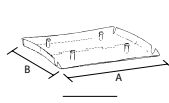

08

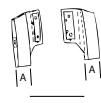

09

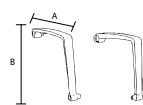

10

19 square-porte-revues
square-rejilla revistero

code	finishing	q.kit
113403-003	● noir/negro	x1

11 vis tête cylindrique croix m6x16 zinguée
tornillo cabeza cilíndrica en cruz m6x16 galvanizado

code	finishing	q.kit
117711-191	○ zinguée/galvanizado	x4

square-chariot porte-chaises avec accessoires
square-carro para sillas con accesorios negro

code	finishing	q.kit
110803-371	● noir/negro	x1

01 square-châssis pour chaise fixe - embouts pieds non montés
square -estructura para silla fija sin tapones montados bajo las patas

code	finishing	q.kit	q.pack	a	b	c	kg.x1	vol.x1
112603-025	● noir/negro	x1	72	450	500	500	3,20	mc. 0.003
112604-025	● gris/gris	x1	72	450	500	500	3,20	mc. 0.003
112610-025	● chromé/cromado	x1	72	450	500	500	3,20	mc. 0.003

02 pack embouts rectangulaires 25x15
paquete de tacos rectangulares 25x15

code	finishing	q.kit	q.pack
137003-074'	● noir/negro	x2	160
134204-020	● gris/gris	x2	

*forniti nella stessa confezione
supplied in the same package

03 pack embouts inclinés rectangulaires 25x15
paquete de tacos inclinados rectangulares 25x15

code	finishing	q.kit	q.pack
137003-074'	● noir/negro	x2	160
134204-023	● gris/gris	x2	

*forniti nella stessa confezione
supplied in the same package

04 embout couvre-tête ø22 pour chaise sans accoudoirs
tapón embellecedor ø22 para silla sin brazos

code	finishing	q.kit
134103-220	● noir/negro	x2
134104-220	● gris/gris	x2

05 square-shi-dossier interne en plastique
square-shi-respaldo interno de plástico

code	finishing	q.kit	q.pack	a	b	kg.x1	vol.x1
132103-006	● noir/negro	x1	20	440	290	0,55	mc. 0.004

06 square-she-dossier externe en plastique
square-she-respaldo externo de plástico

code	finishing	q.kit	q.pack	a	b	kg.x1	vol.x1
132103-005	● noir/negro	x1	20	425	280	0,37	mc. 0.004
132104-026	● gris/gris	x1	20	425	280	0,37	mc. 0.004

07 square-siège interne en plastique
square-asiento interno de plástico

code	finishing	q.kit	q.pack	a	b	kg.x1	vol.x1
132203-007	● noir/negro	x1	20	440	460	0,90	mc. 0.005

08 square-siège externe en plastique
square-asiento externo de plástico

code	finishing	q.kit	q.pack	a	b	kg.x1	vol.x1
132203-006	● noir/negro	x1	20	430	450	0,53	mc. 0.008
132204-026	● gris/gris	x1	20	430	450	0,53	mc. 0.008

09 square-paire de supports dossier en plastique
square-pareja soportes respaldo de plástico

code	finishing	q.kit	q.pack	a	kg.x1	vol.x1
134003-087	● noir/negro	x1	40	25x15	0,16	mc. 0.0002
134004-022	● gris/gris	x1	40	25x15	0,16	mc. 0.0002

10 square-paire d'accoudoirs en plastique
square-pareja de brazos de plástico

code	finishing	q.kit	q.pack	a	b	kg.x1	vol.x1
131703-005	● noir/negro	x1	10	360	260	0,70	mc. 0.006
131704-005	● gris/gris	x1	10	360	260	0,70	mc. 0.006

12 vis tête évasée croix m6x30 zinguée (vis pour fixation siège)
tornillo cabeza avellanada en cruz m6x30 galvanizada (tornillo para fijación asiento)

code	finishing	q.kit
117711-192	○ zinguée/galvanizado	x4

13 vis auto-perceuse 5,5x45 tête évasée croix
tornillo autoroscante 5,5x45 cabeza avellanada en cruz

code	finishing	q.kit
117811-168	○ zinguée/galvanizado	x4

main component sizes

optionals

square

4-legs/tablet and hook options

optionals



14

15

14 15 accoudoirs droit-gauche plastique pour tablette brazos derecho-izquierdo de plástico para pala

code	finishing		q.kit	q.pack	kg.x1	vol.x1
131703-009	● noir/negro	droit/derecha	x1	20	0,70	mc. 0,006
131703-006	● noir/negro	gauche/izquierda	x1	20	0,70	mc. 0,006
131704-003	● gris/gris	droit/derecha	x1	20	0,70	mc. 0,006
131704-004	● gris/gris	gauche/izquierda	x1	20	0,70	mc. 0,006



16

TLT tablet TLT2 tablet TLT3 tablet BEAN tablet TL02 tablet SPT2 mechanism tablet SPTA mechanism antipanic



for writing tablet options, see page 242/243



17

18

16 17 18 attelage latéral mâle-femelle en plastique + 2 vis enganche lateral macho+hembra de plástico + 2 tornillos

code	finishing		q.kit	q.pack	kg.x1	vol.x1
134003-130	● noir/negro		x1	100	0,03	mc. 0,0001
134003-131	● noir/negro	pour accoudoir/para brazo	x1	100	0,03	mc. 0,0001
134003-138	● noir/negro	pour accoudoir avec tablette/ para brazo para pala	x1	100	0,03	mc. 0,0001

4-legs/backrest and seat options

main component sizes

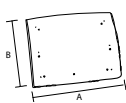

20

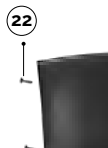

21

20 panneau dossier à revêtir galleta respaldo tapizable

code	finishing		q.kit	q.pack	a	b	kg.x1	vol.x1
132103-046	● noir/negro		x1	20	390	310	0,50	mc. 0,004

21 panneau siège à revêtir galleta asiento tapizable

code	finishing		q.kit	q.pack	a	b	kg.x1	vol.x1
132203-046	● noir/negro		x1	20	400	450	0,60	mc. 0,004

22 pack vis tbl+ fr. d.5x14 pour panneau à revêtir paquete de tornillos tbl+ fr. d.5x14 para galleta tapizable

code	finishing		q.kit	q.pack
117003-071	● noir/negro		x4	200

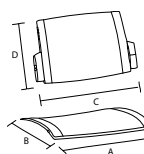

23



23 square-paire assise/dossier en plastique coloré square-pareja asiento/respaldo de plástico de color

code	finishing		q.kit	q.pack	a	b	c	d	kg.x1	vol.x1
134003-088	● noir/negro		x1	10	450	440	500	300	1,62	mc. 0,012
134004-023	● gris/gris	RAL7040	x1	10	450	440	500	300	1,62	mc. 0,012
134002-023	● rouge/rojo	PPL42	x1	10	450	440	500	300	1,62	mc. 0,012
134015-023	● bleu/azul	RAL5002	x1	10	450	440	500	300	1,62	mc. 0,012
134007-023	● orange/naranja	PPL22	x1	10	450	440	500	300	1,62	mc. 0,012
134005-023	● beige/beige	PPL09	x1	10	450	440	500	300	1,62	mc. 0,012

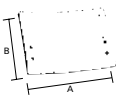

24



24 dossier multicouches hêtre + vis respaldo contrachapado haya + tornillos

code	finishing		q.kit	q.pack	a	b	kg.x1
122107-010	● hêtre/haya		x1	15	425	280	0,50

25 square-siège multicouches hêtre verni + vis square-asiento contrachapado haya pintado + tornillos

code	finishing		q.kit	q.pack	a	b	kg.x1
122207-015	● hêtre/haya		x1	15	422	280	1,65

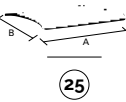

25

square

4-legs for castors



square-chariot porte-chaises avec accessoires
square-carro para sillas con accesorios negro

code	finishing	q.kit
110803-371	● noir/negro	x1

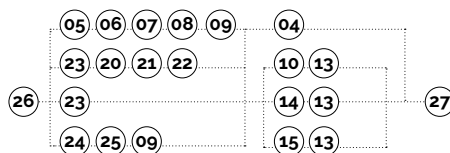

main component sizes

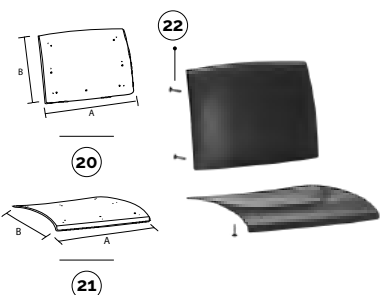
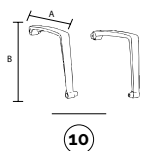
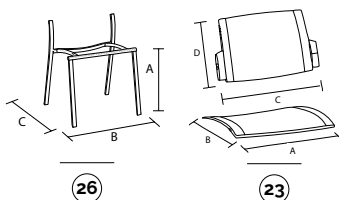

optionals



26 châssis pour chaise 4 pieds prévu pour 4 roulettes + 4 embouts porte roulettes
estructura para silla 4 patas predispuesta para 4 ruedas + 4 tapones portaruedas

code	finishing	q.kit	q.pack	a	b	c	kg.x1	vol.x1
112603-027	● noir/negro	x1	80	450	500	500	3,10	mc. 0,003
112604-027	● gris/gris	x1	80	450	500	500	3,10	mc. 0,003
112610-027	● chromé/cromado	x1	80	450	500	500	3,10	mc. 0,003

04 embout couvre-tête ø22 pour chaise sans accoudoirs
tapón embellecedor ø22 para silla sin brazos

code	finishing	q.kit
134103-220	● noir/negro	x2
134104-220	● gris/gris	x2

23 square-paire assise/dossier en plastique coloré
square-pareja asiento/respaldo de plástico de color

code	finishing	q.kit	q.pack	a	b	c	d	kg.x1	vol.x1
134003-088	● noir/negro	x1	10	450	440	500	300	1,62	mc. 0,012
134004-023	● gris/gris	x1	10	450	440	500	300	1,62	mc. 0,012
134002-023	● rouge/rojo	x1	10	450	440	500	300	1,62	mc. 0,012
134015-023	● bleu/azul	x1	10	450	440	500	300	1,62	mc. 0,012
134007-023	● orange/naranja	x1	10	450	440	500	300	1,62	mc. 0,012
134005-023	● beige/beige	x1	10	450	440	500	300	1,62	mc. 0,012

20 panneau dossier à revêtir
galleta respaldo tapizable

code	finishing	q.kit	q.pack	a	b	kg.x1	vol.x1
132103-046	● noir/negro	x1	20	390	310	0,50	mc. 0,004

21 panneau siège à revêtir
galleta asiento tapizable

code	finishing	q.kit	q.pack	a	b	kg.x1	vol.x1
132203-046	● noir/negro	x1	20	400	450	0,60	mc. 0,004

10 square-paire d'accoudoirs en plastique
square-pareja de brazos de plástico

code	finishing	q.kit	q.pack	a	b	kg.x1	vol.x1
131703-005	● noir/negro	x1	10	360	260	0,70	mc. 0,006
131704-005	● gris/gris	x1	10	360	260	0,70	mc. 0,006

22 pack vis tbl+ fr. d.5x14 pour panneau à revêtir
paquete de tornillos tbl+ fr. d.5x14 para galleta tapizable

code	finishing	q.kit	q.pack
117003-071	● noir/negro	x4	200

27 double roulette ø36 en pa (revêtue de pur)
rueda doble ø36 de pa (recubierta con pur)

code	finishing	q.kit
134403-001	● noir/negro	x4

27 pied moleté ø8 zingué
pata moleteada ø8 galvanizada

code	finishing	q.kit
117911-300	○ zinguée/galvanizado	x4

14 **15** accoudoirs droit-gauche plastique pour tablette
brazos derecho-izquierdo de plástico para pala

code	finishing	q.kit	q.pack	kg.x1	vol.x1
131703-009	● noir/negro	x1	20	0,70	mc. 0,006
131703-006	● noir/negro	x1	20	0,70	mc. 0,006
131704-003	● gris/gris	x1	20	0,70	mc. 0,006
131704-004	● gris/gris	x1	20	0,70	mc. 0,006

square

4-legs for castors/backrest and seat options

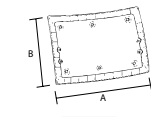

05

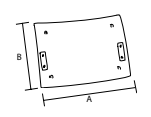

06

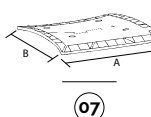

07

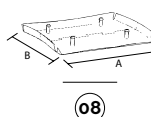

08

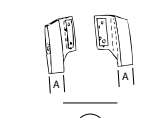

09



05 square-shi-dossier interne en plastique
square-shi-respaldo interno de plástico

code	finishing	q.kit	q.pack	a	b	kg.x1	vol.x1
132103-006	● noir/negro	x1	20	440	290	0,55	mc. 0,004

06 square-she-dossier externe en plastique
square-she-respaldo externo de plástico

code	finishing	q.kit	q.pack	a	b	kg.x1	vol.x1
132103-005	● noir/negro	x1	20	425	280	0,37	mc. 0,004
132104-026	● gris/gris	x1	20	425	280	0,37	mc. 0,004

07 square-siège interne en plastique
square-asiento interno de plástico

code	finishing	q.kit	q.pack	a	b	kg.x1	vol.x1
132203-007	● noir/negro	x1	20	440	460	0,90	mc. 0,005

08 square-siège externe en plastique
square-asiento externo de plástico

code	finishing	q.kit	q.pack	a	b	kg.x1	vol.x1
132203-006	● noir/negro	x1	20	430	450	0,53	mc. 0,008
132204-026	● gris/gris	x1	20	430	450	0,53	mc. 0,008

09 square-paire de supports dossier en plastique
square-pareja soportes respaldo de plástico

code	finishing	q.kit	q.pack	a	kg.x1	vol.x1
134003-087	● noir/negro	x1	40	25x15	0,16	mc. 0,0002
134004-022	● gris/gris	x1	40	25x15	0,16	mc. 0,0002

and 11 12 04

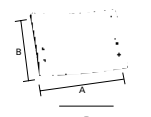

24

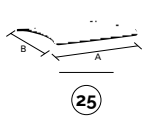

25



24 dossier multicouches hêtre + vis
respaldo contrachapado haya + tornillos

code	finishing	q.kit	q.pack	a	b	kg.x1
122107-010	● hêtre/haya	x1	15	425	280	0,50

25 square-siège multicouches hêtre verni + vis
square-asiento contrachapado haya pintado + tornillos

code	finishing	q.kit	q.pack	a	b	kg.x1
122207-015	● hêtre/haya	x1	15	422	280	1,65

and 09 10 13

main component sizes

square

slide

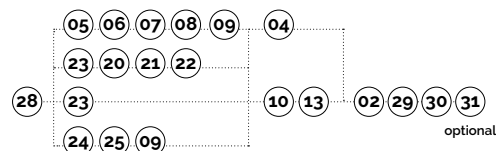

main component sizes

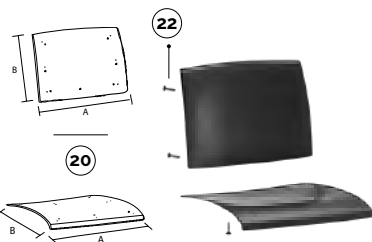
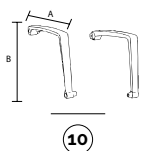
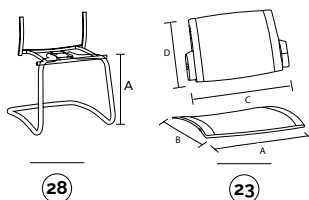

28 base coulisse base patin

code	finishing	q.kit	q.pack	a	kg.x1	vol.x1
110503-013	● noir/negro	x1	80	450	6,50	mc. 0.03
110504-017	● gris/gris	x1	80	450	6,50	mc. 0.03
110510-016	● chromé/cromado	x1	80	450	6,50	mc. 0.03

29 p2p pince deux broches en polyéthylène noire p2p pinza dos ganchos de polietileno negra

code	finishing	q.kit
134003-003	● noir/negro	x4

30 embout couvre-tête d.25 noir tapon embellecedor d.25 negro

code	finishing	q.kit
134103-250	● noir/negro	x2

31 pied anticapotage en plastique noir pie antivuelco de plástico negro

code	finishing	q.kit	q.pack	kg.x1	vol.x1
134303-006	● noir/negro	x2	100	0,025	mc. 0.0001

23 square-paire assise/dossier en plastique coloré square-pareja asiento/respaldo de plástico de color

code	finishing	q.kit	q.pack	a	b	c	d	kg.x1	vol.x1
134003-088	● noir/negro	x1	10	450	440	500	300	1,62	mc. 0.012
134004-023	● gris/gris	x1	10	450	440	500	300	1,62	mc. 0.012
134002-023	● rouge/rojo	x1	10	450	440	500	300	1,62	mc. 0.012
134015-023	● bleu/azul	x1	10	450	440	500	300	1,62	mc. 0.012
134007-023	● orange/naranja	x1	10	450	440	500	300	1,62	mc. 0.012
134005-023	● beige/beige	x1	10	450	440	500	300	1,62	mc. 0.012

20 panneau dossier à revêtir galleta respaldo tapizable

code	finishing	q.kit	q.pack	a	b	kg.x1	vol.x1
132103-046	● noir/negro	x1	20	390	310	0,50	mc. 0.004

21 panneau siège à revêtir galleta asiento tapizable

code	finishing	q.kit	q.pack	a	b	kg.x1	vol.x1
132203-046	● noir/negro	x1	20	400	450	0,60	mc. 0.004

10 square-paire d'accoudoirs en plastique square-pareja de brazos de plástico

code	finishing	q.kit	q.pack	a	b	kg.x1	vol.x1
131703-005	● noir/negro	x1	10	360	260	0,70	mc. 0.006
131704-005	● gris/gris	x1	10	360	260	0,70	mc. 0.006

22 pack vis tbl+ fr. d.5x14 pour panneau à revêtir paquete de tornillos tbl+ fr. d.5x14 para galleta tapizable

code	finishing	q.kit	q.pack
117003-071	● noir/negro	x4	200

02 embout à ailettes rectangulaire 25x15 tapon con aletas rectangular 25x15

code	finishing	q.kit
134203-020	● noir/negro	x2
134204-020	● gris/gris	x2

04 embout couvre-tête ø22 pour chaise sans accoudoirs tapon embellecedor ø22 para silla sin brazos

code	finishing	q.kit
134103-220	● noir/negro	x2
134104-220	● gris/gris	x2

optionals

square

slide/ backrest and seat options

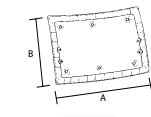

05

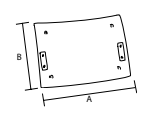

06

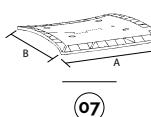

07

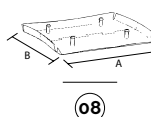

08

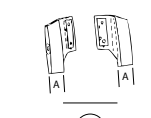

09



05 square-shi-dossier interne en plastique
square-shi-respaldo interno de plástico

code	finishing	q.kit	q.pack	a	b	kg.x1	vol.x1
132103-006	● noir/negro	x1	20	440	290	0,55	mc. 0.004

06 square-she-dossier externe en plastique
square-she-respaldo externo de plástico

code	finishing	q.kit	q.pack	a	b	kg.x1	vol.x1
132103-005	● noir/negro	x1	20	425	280	0,37	mc. 0.004
132104-026	● gris/gris	x1	20	425	280	0,37	mc. 0.004

07 square-siège interne en plastique
square-asiento interno de plástico

code	finishing	q.kit	q.pack	a	b	kg.x1	vol.x1
132203-007	● noir/negro	x1	20	440	460	0,90	mc. 0.005

08 square-siège externe en plastique
square-asiento externo de plástico

code	finishing	q.kit	q.pack	a	b	kg.x1	vol.x1
132203-006	● noir/negro	x1	20	430	450	0,53	mc. 0.008
132204-026	● gris/gris	x1	20	430	450	0,53	mc. 0.008

09 square-paire de supports dossier en plastique
square-pareja soportes respaldo de plástico

code	finishing	q.kit	q.pack	a	kg.x1	vol.x1
134003-087	● noir/negro	x1	40	25x15	0,16	mc. 0.0002
134004-022	● gris/gris	x1	40	25x15	0,16	mc. 0.0002

and - **11** **12** **10** **13** **02**

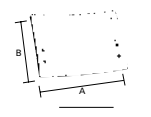

24

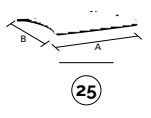

25



24 dossier multicouches hêtre + vis
respaldo contrachapado haya + tornillos

code	finishing	q.kit	q.pack	a	b	kg.x1
122107-010	● hêtre/haya	x1	15	425	280	0,50

25 square-siège multicouches hêtre verni + vis
square-asiento contrachapado haya pintado + tornillos

code	finishing	q.kit	q.pack	a	b	kg.x1
122207-015	● hêtre/haya	x1	15	422	280	1,65

and - **09** **04** **02**

main component sizes

square

swivel

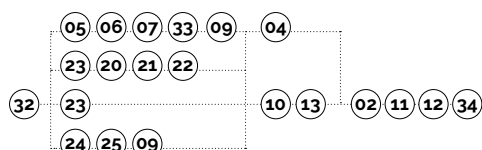

main component sizes

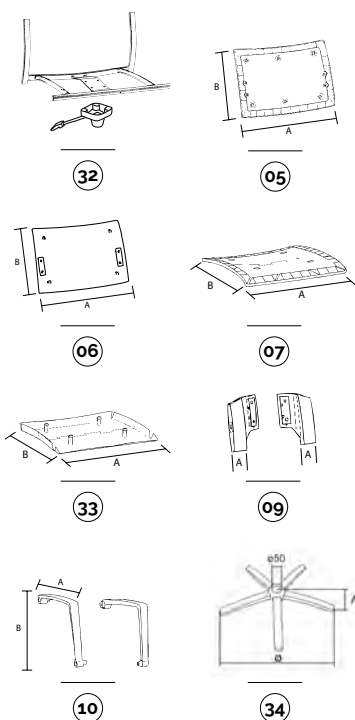

32 châssis pivotant avec dispositif de commande au gaz

estructura versión giratoria con accionamiento mediante mecanismo de gas

code	finishing	q.kit	q.pack	kg.x1	vol.x1
112603-029	● noir/negro	x1	100	3,50	mc. 0,05
112604-029	● gris/gris	x1	100	3,50	mc. 0,05

02 embout à ailettes rectangulaire 25x15

tapón con aletas rectangular 25x15

code	finishing	q.kit
134203-020	● noir/negro	x2
134204-020	● gris/gris	x2

04 embout couvre-tête ø22 pour chaise sans accoudoirs

tapón embellecedor ø22 para silla sin brazos

code	finishing	q.kit
134103-220	● noir/negro	x2
134104-220	● gris/gris	x2

05 square-shi-dossier interne en plastique

square-shi-respaldo interno de plástico

code	finishing	q.kit	q.pack	a	b	kg.x1	vol.x1
132103-006	● noir/negro	x1	20	440	290	0,55	mc. 0,004

06 square-she-dossier externe en plastique

square-she-respaldo externo de plástico

code	finishing	q.kit	q.pack	a	b	kg.x1	vol.x1
132103-005	● noir/negro	x1	20	425	280	0,37	mc. 0,004
132104-026	● gris/gris	x1	20	425	280	0,37	mc. 0,004

07 square-siège interne en plastique

square-asiento interno de plástico

code	finishing	q.kit	q.pack	a	b	kg.x1	vol.x1
132203-007	● noir/negro	x1	20	440	460	0,90	mc. 0,005

33 square-siège externe en plastique

square-asiento externo de plástico

code	finishing	q.kit	q.pack	a	b	kg.x1	vol.x1
132203-008	● noir/negro	x1	20	430	450	0,53	mc. 0,008
132204-027	● gris/gris	x1	20	430	450	0,53	mc. 0,008

09 square-paire de supports dossier en plastique

square-pareja soportes respaldo de plástico

code	finishing	q.kit	q.pack	a	kg.x1	vol.x1
134003-087	● noir/negro	x1	40	25x15	0,16	mc. 0,0002
134004-022	● gris/gris	x1	40	25x15	0,16	mc. 0,0002

10 square-paire d'accoudoirs en plastique

square-pareja de brazos de plástico

code	finishing	q.kit	q.pack	a	b	kg.x1	vol.x1
131703-005	● noir/negro	x1	10	360	260	0,70	mc. 0,006
131704-005	● gris/gris	x1	10	360	260	0,70	mc. 0,006

11 vis tête cylindrique croix m6x16 zinguée

tornillo cabeza cilíndrica en cruz m6x16 galvanizado

code	finishing	q.kit
117711-191	○ zinguée/galvanizado	x4

12 vis tête évasée croix m6x30 zinguée (vis pour fixation siège)

tornillo cabeza avellanada en cruz m6x30 galvanizada (tornillo para fijación asiento)

code	finishing	q.kit
117711-192	○ zinguée/galvanizado	x4

34 b40-base en métal avec cache-soudure

b40-base de metal con embellecedor soldadura

code	finishing	q.kit	q.pack	a	ø	kg.x1	vol.x1
110210-027	● chromé/cromado	x1	5	60	640	2,85	mc. 0,014

square

swivel/backrest and seat options

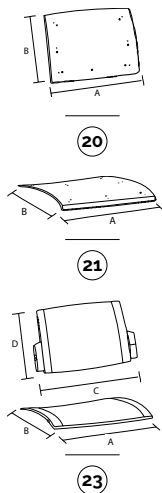

23 square-paire assise/dossier en plastique coloré square-paireja asiento/respaldo de plástico de color

code	finishing	q.kit	q.pack	a	b	c	d	kg.x1	vol.x1
134003-088	● noir/negro	x1	10	450	440	500	300	1.62	mc. 0,012
134004-023	● gris/gris RAL7040	x1	10	450	440	500	300	1.62	mc. 0,012
134002-023	● rouge/rojo PPL42	x1	10	450	440	500	300	1.62	mc. 0,012
134015-023	● bleu/azul RAL5002	x1	10	450	440	500	300	1.62	mc. 0,012
134007-023	● orange/naranja PPL22	x1	10	450	440	500	300	1.62	mc. 0,012
134005-023	● beige/beige PPL09	x1	10	450	440	500	300	1.62	mc. 0,012

20 panneau dossier à revêtir galleta respaldo tapizable

code	finishing	q.kit	q.pack	a	b	kg.x1	vol.x1
132103-046	● noir/negro	x1	20	390	310	0,50	mc. 0,004

21 panneau siège à revêtir galleta asiento tapizable

code	finishing	q.kit	q.pack	a	b	kg.x1	vol.x1
132203-046	● noir/negro	x1	20	400	450	0,60	mc. 0,004

22 pack vis tbl+ fr. d.5x14 pour panneau à revêtir paquete de tornillos tbl+ fr. d.5x14 para galleta tapizable

code	finishing	q.kit	q.pack
117003-071	● noir/negro	x4	200

and - 04 02

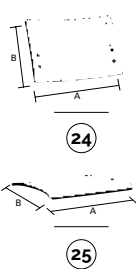

24 dossier multicouches hêtre + vis respaldo contrachapado haya + tornillos

code	finishing	q.kit	q.pack	a	b	kg.x1
122107-010	● hêtre/haya	x1	15	425	280	0,50

25 square-siège multicouches hêtre verni + vis square-asiento contrachapado haya pintado + tornillos

code	finishing	q.kit	q.pack	a	b	kg.x1
122207-015	● hêtre/haya	x1	15	422	280	1,65

and - 09 04 02

square bench

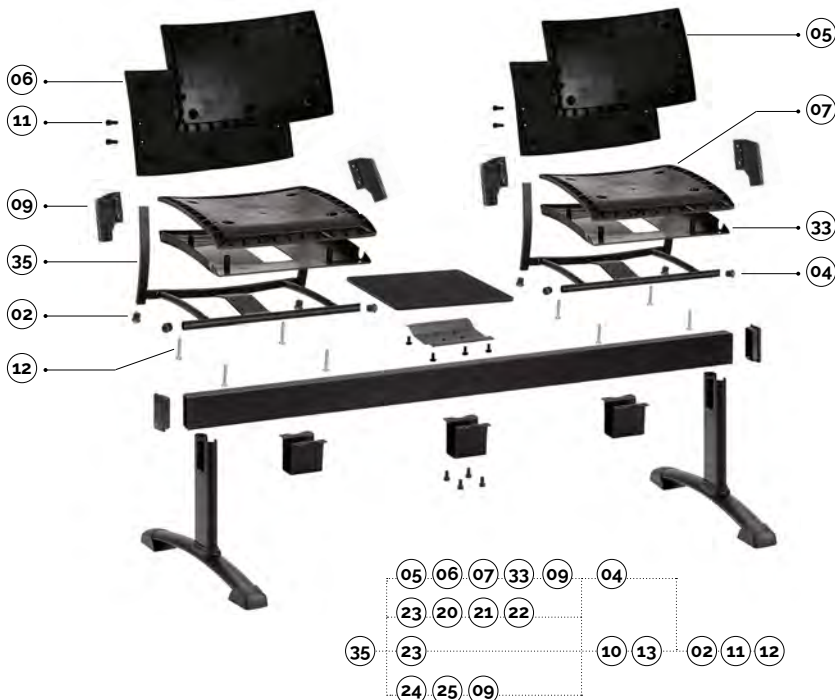

main component sizes

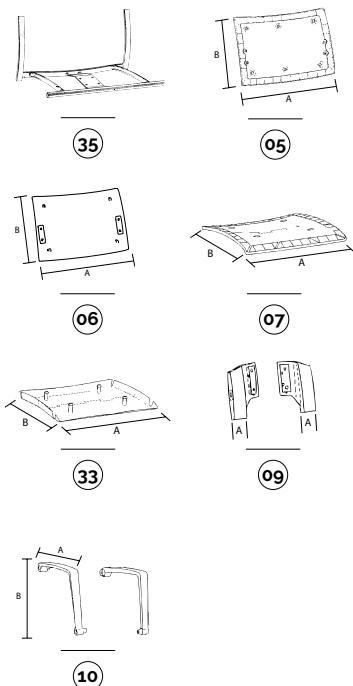

35 square-structure pour banquette sans embouts square-estructura bancada sin tapones

code	finishing	q.kit	q.pack	kg.x1	vol.x1
110703-050	● noir/negro	x1	100	2.80	mc. 0.020
110704-063	● gris/gris	x1	100	2.80	mc. 0.020

02 embout à ailettes rectangulaire 25x15 tapon con aletas rectangular 25x15

code	finishing	q.kit
134203-020	● noir/negro	x2
134204-020	● gris/gris	x2

04 embout couvre-tête ø22 pour chaise sans accoudoirs tapón embellecedor ø22 para silla sin brazos

code	finishing	q.kit
134103-220	● noir/negro	x2
134104-220	● gris/gris	x2

05 square-shi-dossier interne en plastique square-shi-respaldo interno de plástico

code	finishing	q.kit	q.pack	a	b	kg.x1	vol.x1
132103-006	● noir/negro	x1	20	440	290	0.55	mc. 0.004

06 square-she-dossier externe en plastique square-she-respaldo externo de plástico

code	finishing	q.kit	q.pack	a	b	kg.x1	vol.x1
132103-005	● noir/negro	x1	20	425	280	0.37	mc. 0.004
132104-026	● gris/gris	x1	20	425	280	0.37	mc. 0.004

07 square-siège interne en plastique square-asiento interno de plástico

code	finishing	q.kit	q.pack	a	b	kg.x1	vol.x1
132203-007	● noir/negro	x1	20	440	460	0.90	mc. 0.005

33 square-siège externe en plastique square-asiento externo de plástico

code	finishing	q.kit	q.pack	a	b	kg.x1	vol.x1
132203-008	● noir/negro	x1	20	430	450	0.53	mc. 0.008
132204-027	● gris/gris	x1	20	430	450	0.53	mc. 0.008

09 square-paire de supports dossier en plastique square-pareja soportes respaldo de plástico

code	finishing	q.kit	q.pack	a	kg.x1	vol.x1
134003-087	● noir/negro	x1	40	25x15	0.16	mc. 0.0002
134004-022	● gris/gris	x1	40	25x15	0.16	mc. 0.0002

10 square-paire d'accoudoirs en plastique square-pareja de brazos de plástico

code	finishing	q.kit	q.pack	a	b	kg.x1	vol.x1
131703-005	● noir/negro	x1	10	360	260	0.70	mc. 0.006
131704-005	● gris/gris	x1	10	360	260	0.70	mc. 0.006

11 vis tête cylindrique croix m6x16 zinguée tornillo cabeza cilíndrica en cruz m6x16 galvanizado

code	finishing	q.kit
117711-191	○ zinguée/galvanizado	x4

12 vis tête évasée croix m6x30 zinguée (vis pour fixation siège) tornillo cabeza avellanada en cruz m6x30 galvanizada (tornillo para fijación asiento)

code	finishing	q.kit
117711-192	○ zinguée/galvanizado	x4

for the bench components, see page 417

OPTIONAL
bench connector
E-USB
bench plug



JIM
bench leg



plastic

90GM
bench leg



90GF
bench leg



91GM **NEW**
bench leg



100GM
bench leg



200GM
bench leg



PIONEER
bench arm



CUT
bench leg



SLIM
bench leg



CUT
bench arm



SLIM
bench arm



metal

aluminium

optionals

square

bench/backrest and seat options

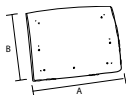

20

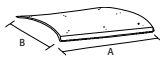

21



23



23 square-paire assise/dossier en plastique coloré
square-paireja asiento/respaldo de plástico de color

code	finishing	q.kit	q.pack	a	b	c	d	kg.x1	vol.x1
134003-088	● noir/negro	x1	10	450	440	500	300	1.62	mc. 0,012
134004-023	● gris/gris RAL7040	x1	10	450	440	500	300	1.62	mc. 0,012
134002-023	● rouge/rojo PPL42	x1	10	450	440	500	300	1.62	mc. 0,012
134015-023	● bleu/azul RAL5002	x1	10	450	440	500	300	1.62	mc. 0,012
134007-023	● orange/naranja PPL22	x1	10	450	440	500	300	1.62	mc. 0,012
134005-023	● beige/beige PPL09	x1	10	450	440	500	300	1.62	mc. 0,012

20 panneau dossier à revêtir
galleta respaldo tapizable

code	finishing	q.kit	q.pack	a	b	kg.x1	vol.x1
132103-046	● noir/negro	x1	20	390	310	0,50	mc. 0,004

21 panneau siège à revêtir
galleta asiento tapizable

code	finishing	q.kit	q.pack	a	b	kg.x1	vol.x1
132203-046	● noir/negro	x1	20	400	450	0,60	mc. 0,004

22 pack vis tbl+ fr. d.5x14 pour panneau à revêtir
paquete de tornillos tbl+ fr. d.5x14 para galleta tapizable

code	finishing	q.kit	q.pack
117003-071	● noir/negro	x4	200

and · 04 02

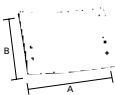

24

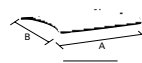

25



24 dossier multicouches hêtre + vis
respaldo contrachapado haya + tornillos

code	finishing	q.kit	q.pack	a	b	kg.x1
122107-010	● hêtre/haya	x1	15	425	280	0,50

25 square-siège multicouches hêtre verni + vis
square-asiento contrachapado haya pintado + tornillos

code	finishing	q.kit	q.pack	a	b	kg.x1
122207-015	● hêtre/haya	x1	15	422	280	1,65

and · 09 04 02

main component sizes



logan



discover more about
Logan Collection

Cette assise est certifiée CATAS et BIFMA. Elle est extrêmement polyvalente grâce à son dossier proposé en plastique plein ou ajouré, ou à tapisser ou encore en résille, ce qui lui confère un design caractéristique. Elle peut être associée à tous les châssis proposés en assortiment; les accoudoirs en plastique avec ou sans crochet porte-tablette et les crochets latéraux sont disponibles en option. Logan assure une ligne riche et complète.

Logan est parfaite pour les Bureaux et les salles d'attente.

El asiento certificado CATAS y BIFMA. Es sumamente versátil con su respaldo, disponible en plástico macizo o perforado, o para tapizar o incluso en malla, y que le regala un diseño distintivo. Se combina con todas las estructuras disponibles del surtido: los brazos son opcionales de plástico con o sin enganche para la pala y los enganches laterales. Logan garantiza una línea rica y completa.

Logan es ideal para los ambientes de la oficina y la comunidad.

Plus

- Certification ANSI/BIFMA X5.1.
- Grande polyvalence grâce au grand choix de dossiers confortables étant proposés.
- Une ligne fonctionnelle et complète.
- *Certificación ANSI/BIFMA X5.1.*
- *Gran versatilidad con su respaldo cómodo, disponible en numerosas alternativas.*
- *Línea funcional y completa.*



**trolley
available**



**certified
product**

logan

slide

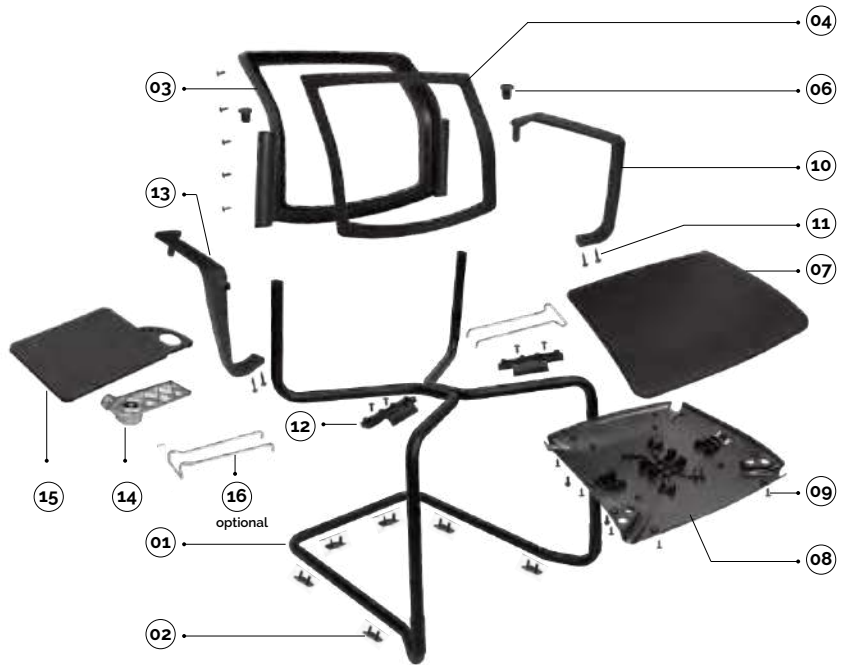

plastic colours

- noir/negro
- gris/gris ral 7040
- blanc/blanco ral 9003
- bleu/azul ral 5014

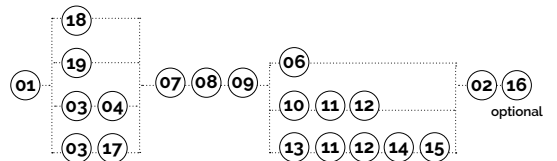

main component sizes

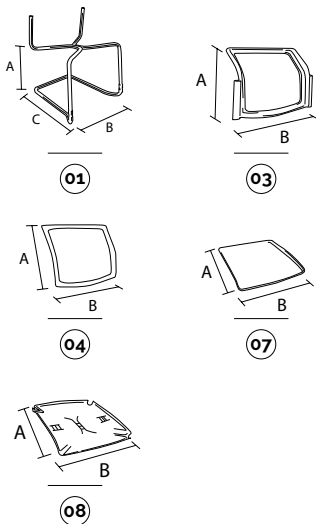

optionals

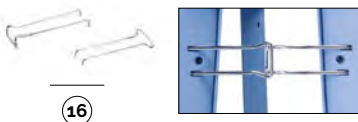

01 logan-base coulissante en tube asform d.22 embouts exclus

logan-base patin tubular asform d. 22 tapones excluidos

code	finishing	q.kit	q.pack	a	b	c	kg.x1	vol.x1
110503-059	● noir/negro	x1	50	450	550	550	4,70	mc. 0.06
110504-059	● gris/gris ig2621	x1	50	450	550	550	4,70	mc. 0.06
110510-059	● chromé/cromado	x1	50	450	550	550	4,70	mc. 0.06

02 p2p-pince deux broches en polyéthylène noire

p2p -pinza dos ganchos de polietileno negra

code	finishing	q.kit
134003-003	● noir/negro	x6

03 logan-châssis dossier en plastique porteur

logan-estructura respaldo de plástico portante

code	finishing	q.kit	q.pack	a	b	kg.x1	vol.x1
132103-084	● noir/negro	x1	10	390	500	0,58	mc. 0.088

04 logan-cadre dossier en plastique pour treillis

logan-marco respaldo de plástico para malla

code	finishing	q.kit	q.pack	a	b	kg.x1	vol.x1
132103-085	● noir/negro	x1	20	380	420	0,30	mc. 0.005

06 logan-embout pour châssis et dossier

logan-tapón para estructura y respaldo

code	finishing	q.kit	q.pack	kg.x1	vol.x1
131703-029	● noir/negro	x2	20	0,025	mc. 0.001

07 logan-siège de vue en plastique coloré

logan-asiento de plástico de color

code	finishing	q.kit	q.pack	a	b	kg.x1	vol.x1
132203-082	● noir/negro	x1	10	430	460	0,86	mc. 0.01

08 logan-renfort d'assise en plastique coloré pour châssis 4 pieds et coulissant

logan-parte inferior asiento de color base de plástico para estructura 4 patas y patin

code	finishing	q.kit	q.pack	a	b	kg.x1	vol.x1
132203-080	● noir/negro	x1	20	420	450	0,51	mc. 0.007

09 logan-sachet avec vis + pf1 pour 10 chaises - pour assise

logan-bolsa con tornillos + pf1 para 10 sillas - para asiento

code	finishing	q.kit	q.pack
117000-022	● noir/negro	x0.1	1

16 logan-paire de grappins d'attelage latéral mâle + femelle chromés

logan-pareja enganches laterales macho + hembra cromados

code	finishing	q.kit	q.pack	kg.x1	vol.x1
113410-100	● chromé/cromado	x1	100	0,13	mc. 0.0004

logan

slide/tablet accessories

main component sizes

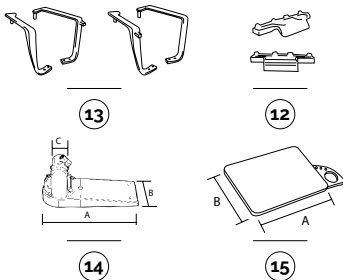

13 logan-paire d'accoudoirs avec attelage porte-tablette en plastique

logan-pareja brazos con gancho pala de plástico

code	finishing	q.kit	q.pack	kg.x1	vol.x1
131703-032	● noir/negro	x1	10	left + right writing tablet hook	0.49 mc. 0.051
131703-033	● noir/negro	x1	10	right + left writing tablet hook	0.49 mc. 0.051

11 logan-kit vis pour 10 paires d'accoudoirs

logan-kit de tornillos para 10 parejas de brazos

code	finishing	q.kit	q.pack	kg.x1	vol.x1
117000-025	● noir/negro	x0.1	1		

12 logan-plaque de fixation pour accoudoir

logan-placa de fijación para brazo

code	finishing	q.kit	q.pack	kg.x1	vol.x1
131703-034	● noir/negro	x2	50	0.07	mc. 0.0013

14 spta-rotule tablette anti-panique en aluminium poli

spta-articulación pala antipánico de aluminio brillante

code	finishing	q.kit	q.pack	a	b	c	kg.x1	vol.x1
111701-900	● aluminium/aluminio droit/derecha	x1	10	180	66	15x15	0.365	mc. 0.001
111701-901	● aluminium/aluminio gauche/izquierda	x1	10	180	66	15x15	0.365	mc. 0.001

15 tlt3-tablette ambidextre avec porte-verre et porte-stylos

tlt3-pala ambidextro con hueco vasos y lapicero

code	finishing	q.kit	q.pack	a	b	kg.x1	vol.x1
134003-041	● noir/negro	x1	10	410	300	1.05	mc. 0.036

TLT tablet TLT2 tablet TLT3 tablet BEAN tablet TL02 tablet SPT2 mechanism tablet SPTA mechanism antipanic



for writing tablet options, see page 404/405

slide/options

main component sizes

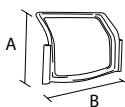

03

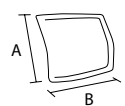

17



10



03 logan-châssis dossier en plastique porteur

logan-estructura respaldo de plástico portante

code	finishing	q.kit	q.pack	a	b	kg.x1	vol.x1
132103-084	● noir/negro	x1	10	390	500	0.58	mc. 0.088

17 logan-panneau dossier en plastique à revêtir

logan-galleta respaldo de plástico tapizable

code	finishing	q.kit	q.pack	a	b	kg.x1	vol.x1
132103-086	● noir/negro	x1	20	380	420	0.90	mc. 0.005

10 logan-paire d'accoudoirs droit-gauche plastique

logan-pareja brazos derecho-izquierdo de plástico

code	finishing	q.kit	q.pack	kg.x1	vol.x1
131703-031	● noir/negro	x1	10	0.43	mc. 0.051

and · 11 12 07 08 09

main component sizes

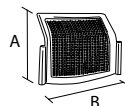

18

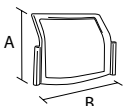

19



18 logan-dossier perforé en plastique coloré

logan-respaldo perforado de plástico de color base

code	finishing	q.kit	q.pack	a	b	kg.x1	vol.x1
132103-083	● noir/negro	x1	10	390	500	0.82	mc. 0.088

19 logan-dossier plein en plastique coloré

logan-respaldo lleno de plástico de color

code	finishing	q.kit	q.pack	a	b	kg.x1	vol.x1
132103-089	● noir/negro	x1	10	390	500	0.82	mc. 0.088

and · 06 07 08 09



for all colour codes, see page 227

logan

4-legs



CERTIFIED BY
BIFMA

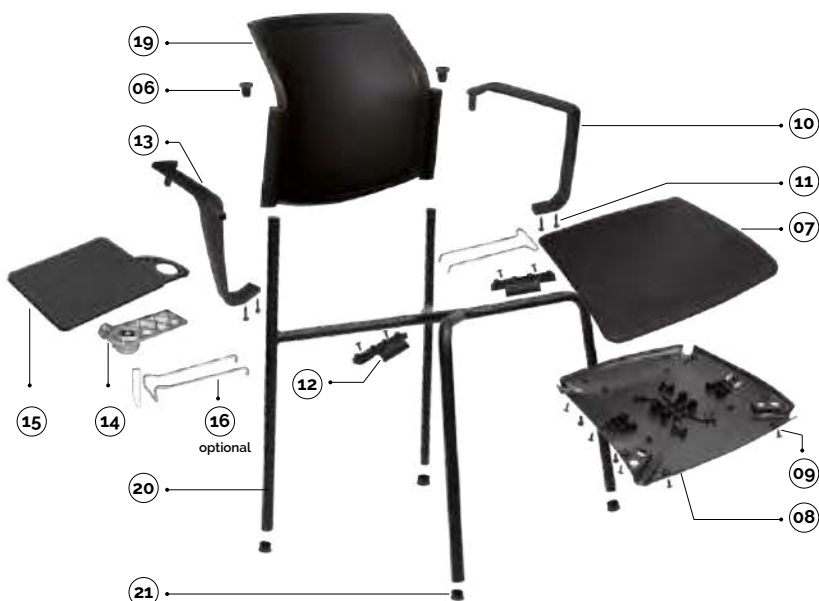

plastic colours

- noir/negro
- gris/gris ral 7040
- blanc/blanco ral 9003
- bleu/azul ral 5014

logan-chariot porte-chaises avec accessoires nero
logan-carro para sillas con accesorios black

code	finishing	q.kit
110803-344	● noir/negro	x1

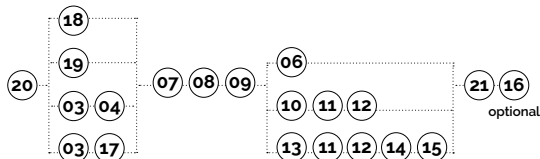

main component sizes

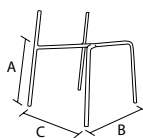

20

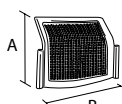

18

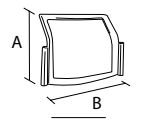

19

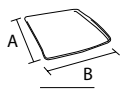

07

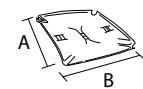

08



16



20 logan-châssis 4 pieds tube d.22 sans embouts logan-estructura 4 patas d. 22 con brazos sin tapones

code	finishing	q.kit	q.pack	a	b	c	kg.x1	vol.x1
110603-059	● noir/negro	x1	72	440	530	510	2,70	mc. 0.017
110604-059	● gris/gris ig2621	x1	72	440	530	510	2,70	mc. 0.017
110610-059	● chromé/cromado	x1	72	440	530	510	2,70	mc. 0.017

21 pack embouts ronds d.22 noirs paquete de tacos redondos d.22 negros

code	finishing	q.kit	q.pack
137003-073	● noir/negro	x4	200

18 logan-dossier perforé en plastique coloré logan-respaldo perforado de plástico de color base

code	finishing	q.kit	q.pack	a	b	kg.x1	vol.x1
132103-083	● noir/negro	x1	10	390	500	0,82	mc. 0.088

19 logan-dossier plein en plastique coloré logan-respaldo lleno de plástico de color

code	finishing	q.kit	q.pack	a	b	kg.x1	vol.x1
132103-089	● noir/negro	x1	10	390	500	0,82	mc. 0.088

06 logan-embout pour châssis et dossier logan-tapón para estructura y respaldo

code	finishing	q.kit	q.pack	kg.x1	vol.x1
131703-029	● noir/negro	x2	20	0,025	mc. 0.001

07 logan-siège de vue en plastique coloré logan-asiento de plástico de color

code	finishing	q.kit	q.pack	a	b	kg.x1	vol.x1
132203-082	● noir/negro	x1	10	430	460	0,86	mc. 0,01

08 logan-renfort d'assise en plastique coloré pour châssis 4 pieds et coulissant logan-parte inferior asiento de color base de plástico para estructura 4 patas y patin

code	finishing	q.kit	q.pack	a	b	kg.x1	vol.x1
132203-080	● noir/negro	x1	20	420	450	0,51	mc. 0.007

09 logan-sachet avec vis + pf1 pour 10 chaises - pour assise logan-bolsa con tornillos + pf1 para 10 sillas - para asiento

code	finishing	q.kit	q.pack
117000-022	● noir/negro	x0.1	1

16 logan-paire de grappins d'attelage latéral mâle + femelle chromés logan-pareja enganches laterales macho + hembra cromados

code	finishing	q.kit	q.pack	kg.x1	vol.x1
113410-100	● chromé/cromado	x1	100	0,13	mc. 0.0004

logan

4-legs/tablet accessories

main component sizes

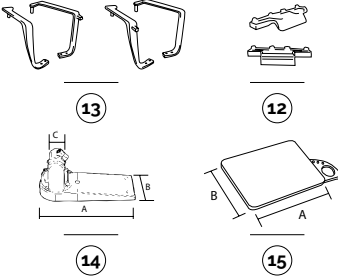

13 logan-paire d'accoudoirs avec attelage porte-tablette en plastique

code	finishing	q.kit	q.pack	kg.x1	vol.x1
131703-032	● noir/negro	x1	10	left + right writing tablet hook	0.49 mc. 0.051
131703-033	● noir/negro	x1	10	right + left writing tablet hook	0.49 mc. 0.051

11 logan-kit vis pour 10 paires d'accoudoirs

code	finishing	q.kit	q.pack	kg.x1	vol.x1
117000-025	● noir/negro	x0.1	1		

12 logan-plaque de fixation pour accoudoir

code	finishing	q.kit	q.pack	kg.x1	vol.x1
131703-034	● noir/negro	x2	50	0.07	mc. 0.0013

14 spta-rotule tablette anti-panique en aluminium poli

code	finishing	q.kit	q.pack	a	b	c	kg.x1	vol.x1
111701-900	● aluminium/aluminio droit/derecha	x1	10	180	66	15x15	0.365	mc. 0.001
111701-901	● aluminium/aluminio gauche/izquierda	x1	10	180	66	15x15	0.365	mc. 0.001

15 tlt3-tablette ambidextre avec porte-verre et porte-stylos

code	finishing	q.kit	q.pack	a	b	kg.x1	vol.x1
134003-041	● noir/negro	x1	10	410	300	1.05	mc. 0.036

TLT tablet TLT2 tablet TLT3 tablet BEAN tablet TL02 tablet SPT2 mechanism tablet SPTA mechanism antipanic



for writing tablet options, see page 404/405

4-legs/options

main component sizes

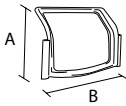

03

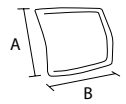

17



10



03 logan-châssis dossier en plastique porteur

code	finishing	q.kit	q.pack	a	b	kg.x1	vol.x1
132103-084	● noir/negro	x1	10	390	500	0.58	mc. 0.088

17 logan-panneau dossier en plastique à revêtir

code	finishing	q.kit	q.pack	a	b	kg.x1	vol.x1
132103-086	● noir/negro	x1	20	380	420	0.90	mc. 0.005

10 logan-paire d'accoudoirs droit-gauche plastique

code	finishing	q.kit	q.pack	kg.x1	vol.x1
131703-031	● noir/negro	x1	10	0.43	mc. 0.051

and · 11 12 07 08 09

main component sizes

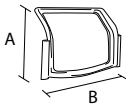

03

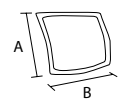

04



03 logan-châssis dossier en plastique porteur

code	finishing	q.kit	q.pack	a	b	kg.x1	vol.x1
132103-084	● noir/negro	x1	10	390	500	0.58	mc. 0.088

04 logan-cadre dossier en plastique pour treillis

code	finishing	q.kit	q.pack	a	b	kg.x1	vol.x1
132103-085	● noir/negro	x1	20	380	420	0.30	mc. 0.005

and · 10 11 12 07 08 09



for all colour codes, see page 227

logan

4-legs for castors



plastic colours

- noir/negro
- gris/gris ral 7040
- blanc/blanco ral 9003
- bleu/azul ral 5014

logan-chariot porte-chaises avec accessoires nero
logan-carro para sillas con accesorios black

code	finishing	q.kit
110803-344	● noir/negro	x1

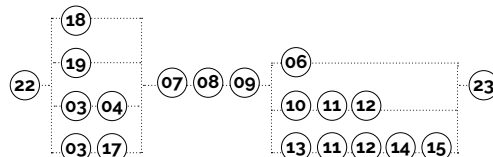

main component sizes

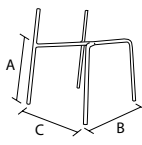

22

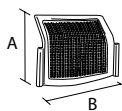

18

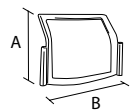

19

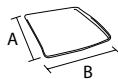

07

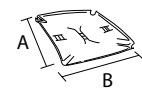

08

22 logan-châssis 4 pieds prévu pour 4 roulettes + 4 embouts porte roulettes
logan-estructura 4 patas predispuesta para 4 ruedas + 4 tapones portaruedas

code	finishing	q.kit	q.pack	a	b	c	kg.x1	vol.x1
110603-058	● noir/negro	x1	80	440	470	510	2,70	mc. 0,017
110604-058	● gris/gris ig2621	x1	80	440	470	510	2,70	mc. 0,017
110610-058	● chromé/cromado	x1	80	440	470	510	2,70	mc. 0,017

23 double roulette ø50 en desmopan tige montée
rueda doble d. 50 de desmopan con perno montado

code	finishing	q.kit
134403-003	● noir/negro	x4

18 logan-dossier perforé en plastique coloré
logan-respaldos perforado de plástico de color base

code	finishing	q.kit	q.pack	a	b	kg.x1	vol.x1
132103-083	● noir/negro	x1	10	390	500	0,82	mc. 0,088

19 logan-dossier plein en plastique coloré
logan-respaldos lleno de plástico de color

code	finishing	q.kit	q.pack	a	b	kg.x1	vol.x1
132103-089	● noir/negro	x1	10	390	500	0,82	mc. 0,088

06 logan-embout pour châssis et dossier
logan-tapón para estructura y respaldos

code	finishing	q.kit	q.pack	kg.x1	vol.x1
131703-029	● noir/negro	x2	20	0,025	mc. 0,001

07 logan-siège de vue en plastique coloré
logan-asiento de plástico de color

code	finishing	q.kit	q.pack	a	b	kg.x1	vol.x1
132203-082	● noir/negro	x1	10	430	460	0,86	mc. 0,01

08 logan-renfort d'assise en plastique coloré pour châssis 4 pieds et coulissant
logan-parte inferior asiento de color base de plástico para estructura 4 patas y patin

code	finishing	q.kit	q.pack	a	b	kg.x1	vol.x1
132203-080	● noir/negro	x1	20	420	450	0,51	mc. 0,007

09 logan-sachet avec vis + pf1 pour 10 chaises - pour assise
logan-bolsa con tornillos + pf1 para 10 sillas - para asiento

code	finishing	q.kit	q.pack
117000-022	● noir/negro	x0,1	1

logan

4-legs for castors/tablet accessories

main component sizes

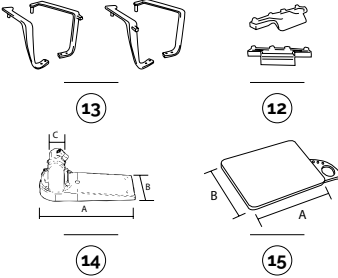

13 logan-paire d'accoudoirs avec attelage porte-tablette en plastique

logan-pareja brazos con gancho pala de plástico

code	finishing	q.kit	q.pack	kg.x1	vol.x1
131703-032	● noir/negro	x1	10	left + right writing tablet hook	0.49 mc. 0.051
131703-033	● noir/negro	x1	10	right + left writing tablet hook	0.49 mc. 0.051

11 logan-kit vis pour 10 paires d'accoudoirs

logan-kit de tornillos para 10 parejas de brazos

code	finishing	q.kit	q.pack	kg.x1	vol.x1
117000-025	● noir/negro	x0.1	1		

12 logan-plaque de fixation pour accoudoir

logan-placa de fijación para brazo

code	finishing	q.kit	q.pack	kg.x1	vol.x1
131703-034	● noir/negro	x2	50	0.07	mc. 0.0013

14 spta-rotule tablette anti-panique en aluminium poli

spta-articulación pala antipánico de aluminio brillante

code	finishing	q.kit	q.pack	a	b	c	kg.x1	vol.x1
111701-900	● aluminium/aluminio droit/derecha	x1	10	180	66	15x15	0.365	mc. 0.001
111701-901	● aluminium/aluminio gauche/izquierda	x1	10	180	66	15x15	0.365	mc. 0.001

15 tlt3-tablette ambidextre avec porte-verre et porte-stylos

tlt3-pala ambidextro con hueco vasos y lapicero

code	finishing	q.kit	q.pack	a	b	kg.x1	vol.x1
134003-041	● noir/negro	x1	10	410	300	1.05	mc. 0.036

TLT tablet TLT2 tablet TLT3 tablet BEAN tablet TL02 tablet SPT2 mechanism tablet SPTA mechanism antipanic



for writing tablet options, see page 404/405

4-legs for castors/options

main component sizes

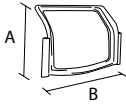

03

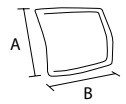

17



10



03 logan-châssis dossier en plastique porteur

logan-estructura respaldo de plástico portante

code	finishing	q.kit	q.pack	a	b	kg.x1	vol.x1
132103-084	● noir/negro	x1	10	390	500	0.58	mc. 0.088

17 logan-panneau dossier en plastique à revêtir

logan-galleta respaldo de plástico tapizable

code	finishing	q.kit	q.pack	a	b	kg.x1	vol.x1
132103-086	● noir/negro	x1	20	380	420	0.90	mc. 0.005

10 logan-paire d'accoudoirs droit-gauche plastique

logan-pareja brazos derecho-izquierdo de plástico

code	finishing	q.kit	q.pack	kg.x1	vol.x1
131703-031	● noir/negro	x1	10	0.43	mc. 0.051

and 11 12 07 08 09

main component sizes

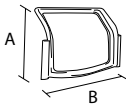

03

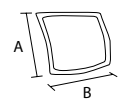

04



03 logan-châssis dossier en plastique porteur

logan-estructura respaldo de plástico portante

code	finishing	q.kit	q.pack	a	b	kg.x1	vol.x1
132103-084	● noir/negro	x1	10	390	500	0.58	mc. 0.088

04 logan-cadre dossier en plastique pour treillis

logan-marco respaldo de plástico para malla

code	finishing	q.kit	q.pack	a	b	kg.x1	vol.x1
132103-085	● noir/negro	x1	20	380	420	0.30	mc. 0.005

and 10 11 12 07 08 09



for all colour codes, see page 227

logan

swivel

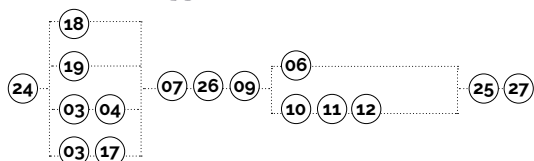

plastic colours

- noir/negro
- gris/gris ral 7040
- blanc/blanco ral 9003
- bleu/azul ral 5014

main component sizes

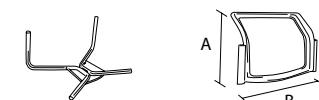

24



03

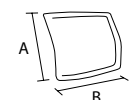

17

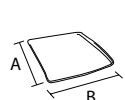

07

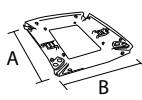

26



10



12

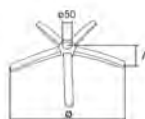

27

24 logan-châssis pour pivotant commande au gaz sans embouts
logan-estructura para versión giratoria accionamiento con gas sin tapones

code	finishing	q.kit	q.pack	kg.x1	vol.x1
110903-024	● noir/negro	x1	100	2,55	mc. 0,046

25 tc22-embout couvre-tête à ailettes d.22 noir
tc22-taco con aletas d.22 negro

code	finishing	q.kit
134103-220	● noir/negro	x2

03 logan-châssis dossier en plastique porteur
logan-estructura respaldo de plástico portante

code	finishing	q.kit	q.pack	a	b	kg.x1	vol.x1
132103-084	● noir/negro	x1	10	390	500	0,58	mc. 0,088

17 logan-panneau dossier en plastique à revêtir
logan-galleta respaldo de plástico tapizable

code	finishing	q.kit	q.pack	a	b	kg.x1	vol.x1
132103-086	● noir/negro	x1	20	380	420	0,90	mc. 0,005

07 logan-siège de vue en plastique coloré
logan-asiento de plástico de color

code	finishing	q.kit	q.pack	a	b	kg.x1	vol.x1
132203-082	● noir/negro	x1	10	430	460	0,86	mc. 0,01

26 logan-renfort d'assise externe en plastique pour châssis banquette et pivotant
logan-parte inferior asiento externo de plástico para estructura banqueta y versión giratoria

code	finishing	q.kit	q.pack	a	b	kg.x1	vol.x1
132203-081	● noir/negro	x1	20	420	450	0,47	mc. 0,007

09 logan-sachet avec vis + pf1 pour 10 chaises - pour assise
logan-bolsa con tornillos + pf1 para 10 sillas - para asiento

code	finishing	q.kit	q.pack
117000-022	● noir/negro	x0.1	1

10 logan-paire d'accoudoirs droit-gauche plastique
logan-pareja brazos derecho-izquierdo de plástico

code	finishing	q.kit	q.pack	kg.x1	vol.x1
131703-031	● noir/negro	x1	10	0,43	mc. 0,051

11 logan-kit vis pour 10 paires d'accoudoirs
logan-kit de tornillos para 10 parejas de brazos

code	finishing	q.kit	q.pack
117000-025	● noir/negro	x0.1	1

12 logan-plaque de fixation pour accoudoir
logan-placa de fijación para brazo

code	finishing	q.kit	q.pack	kg.x1	vol.x1
131703-034	● noir/negro	x2	50	0,07	mc. 0,0013

27 b40-base en métal avec cache-soudure
b40-base de metal con embellecedor soldadura

code	finishing	q.kit	q.pack	a	o	kg.x1	vol.x1
110210-027	● chromé/cromado	x1	5	60	640	2,85	mc. 0,014

logan

swivel/options

main component sizes

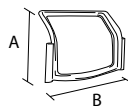

03

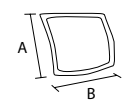

04



03 logan-châssis dossier en plastique porteur

logan-estructura respaldo de plástico portante

code	finishing	q.kit	q.pack	a	b	kg.x1	vol.x1
132103-084	● noir/negro	x1	10	390	500	0,58	mc. 0,088

04 logan-cadre dossier en plastique pour treillis

logan-marco respaldo de plástico para malla

code	finishing	q.kit	q.pack	a	b	kg.x1	vol.x1
132103-085	● noir/negro	x1	20	380	420	0,30	mc. 0,005

and · 10 11 12 07 26 09

main component sizes

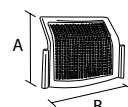

18

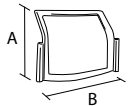

19



18 logan-dossier perforé en plastique coloré

logan-respaldo perforado de plástico de color base

code	finishing	q.kit	q.pack	a	b	kg.x1	vol.x1
132103-083	● noir/negro	x1	10	390	500	0,82	mc. 0,088

19 logan-dossier plein en plastique coloré

logan-respaldo lleno de plástico de color

code	finishing	q.kit	q.pack	a	b	kg.x1	vol.x1
132103-089	● noir/negro	x1	10	390	500	0,82	mc. 0,088

and · 10 11 12 07 26 09



for all colour codes, see page 227

logan

bench



plastic colours

- noir/negro
- gris/gris ral 7040
- blanc/blanco ral 9003
- bleu/azul ral 5014

main component sizes

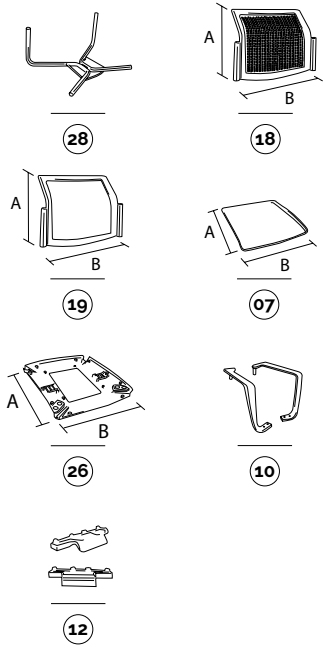

28	logan-châssis pour banquette sans embouts logan-estructura para bancada sin tapones	code 110703-024	finishing ● noir/negro	q.kit x1	q.pack 100	kg.x1 2,20	vol.x1 mc. 0,046		
25	tc22-embout couvre-tête à ailettes d.22 noir tc22-taco con aletas d.22 negro	code 134103-220	finishing ● noir/negro	q.kit x2					
18	logan-dossier perforé en plastique coloré logan-respaldo perforado de plástico de color base	code 132103-083	finishing ● noir/negro	q.kit x1	q.pack 10	a 390	b 500	kg.x1 0,82	vol.x1 mc. 0,088
19	logan-dossier plein en plastique coloré logan-respaldo lleno de plástico de color	code 132103-089	finishing ● noir/negro	q.kit x1	q.pack 10	a 390	b 500	kg.x1 0,82	vol.x1 mc. 0,088
06	logan-embout pour châssis et dossier logan-tapón para estructura y respaldo	code 131703-029	finishing ● noir/negro	q.kit x2	q.pack 20			kg.x1 0,025	vol.x1 mc. 0,001
07	logan-siège de vue en plastique coloré logan-asiento de plástico de color	code 132203-082	finishing ● noir/negro	q.kit x1	q.pack 10	a 430	b 460	kg.x1 0,86	vol.x1 mc. 0,01
26	logan-renfort d'assise externe en plastique pour châssis banquette et pivotant logan-parte inferior asiento externo de plástico para estructura bancada y versión giratoria	code 132203-081	finishing ● noir/negro	q.kit x1	q.pack 20	a 420	b 450	kg.x1 0,47	vol.x1 mc. 0,007
09	logan-sachet avec vis + pf1 pour 10 chaises - pour assise logan-bolsa con tornillos + pf1 para 10 sillas - para asiento	code 117000-022	finishing ● noir/negro	q.kit x0,1	q.pack 1				
10	logan-paire d'accoudoirs droit-gauche plastique logan-pareja brazos derecho-izquierdo de plástico	code 131703-031	finishing ● noir/negro	q.kit x1	q.pack 10			kg.x1 0,43	vol.x1 mc. 0,051
11	logan-kit vis pour 10 paires d'accoudoirs logan-kit de tornillos para 10 parejas de brazos	code 117000-025	finishing ● noir/negro	q.kit x0,1	q.pack 1				
12	logan-plaque de fixation pour accoudoir logan-placa de fijación para brazo	code 131703-034	finishing ● noir/negro	q.kit x2	q.pack 50			kg.x1 0,07	vol.x1 mc. 0,0013

for the bench components, see page 417

optionals

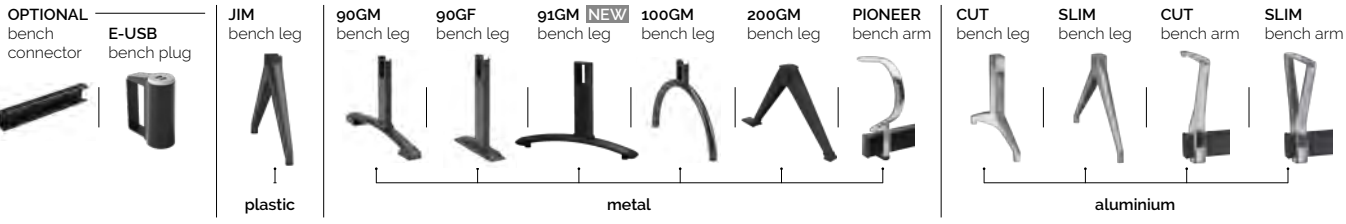

logan

bench/tablet accessories

main component sizes

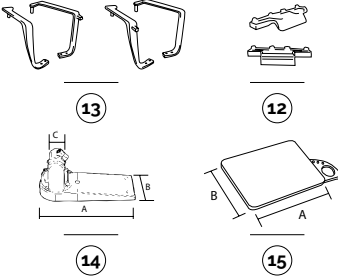

13 logan-paire d'accoudoirs avec attelage porte-tablette en plastique
logan-pareja brazos con gancho pala de plástico

code	finishing	q.kit	q.pack		kg.x1	vol.x1
131703-032	● noir/negro	x1	10	left + right writing tablet hook	0.49	mc. 0.051
131703-033	● noir/negro	x1	10	right + left writing tablet hook	0.49	mc. 0.051

11 logan-kit vis pour 10 paires d'accoudoirs
logan-kit de tornillos para 10 parejas de brazos

code	finishing	q.kit	q.pack		kg.x1	vol.x1
117000-025	● noir/negro	x0.1	1			

12 logan-plaque de fixation pour accoudoir
logan-placa de fijación para brazo

code	finishing	q.kit	q.pack		kg.x1	vol.x1
131703-034	● noir/negro	x2	50		0.07	mc. 0.0013

14 spta-rotule tablette anti-panique en aluminium poli
spta-articulación pala antipánico de aluminio brillante

code	finishing	q.kit	q.pack	a	b	c	kg.x1	vol.x1
111701-900	● aluminium/aluminio droit/derecha	x1	10	180	66	15x15	0.365	mc. 0.001
111701-901	● aluminium/aluminio gauche/izquierda	x1	10	180	66	15x15	0.365	mc. 0.001

15 tlt3-tablette ambidextre avec porte-verre et porte-stylos
tlt3-pala ambidextro con hueco vasos y lapicero

code	finishing	q.kit	q.pack	a	b	kg.x1	vol.x1
134003-041	● noir/negro	x1	10	410	300	1.05	mc. 0.036

TLT tablet TLT2 tablet TLT3 tablet BEAN tablet TL02 tablet SPT2 mechanism tablet SPTA mechanism antipanic



for writing tablet options, see page 404/405

bench/options

main component sizes

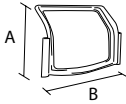

03

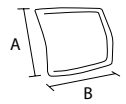

17



10



03 logan-châssis dossier en plastique porteur
logan-estructura respaldo de plástico portante

code	finishing	q.kit	q.pack	a	b	kg.x1	vol.x1
132103-084	● noir/negro	x1	10	390	500	0.58	mc. 0.088

17 logan-panneau dossier en plastique à revêtir
logan-galleta respaldo de plástico tapizable

code	finishing	q.kit	q.pack	a	b	kg.x1	vol.x1
132103-086	● noir/negro	x1	20	380	420	0.90	mc. 0.005

05 vis hilo tc + 4x14 zn noires
tornillo hi-lo tc + 4x14 zn negro

code	finishing	q.kit
117803-120	● noir/negro	x10

10 logan-paire d'accoudoirs droit-gauche plastique
logan-pareja brazos derecho-izquierdo de plástico

code	finishing	q.kit	q.pack	kg.x1	vol.x1
131703-031	● noir/negro	x1	10	0.43	mc. 0.051

and · **11** **12** **07** **26** **09**

main component sizes

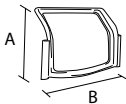

03

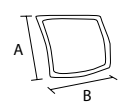

04



03 logan-châssis dossier en plastique porteur
logan-estructura respaldo de plástico portante

code	finishing	q.kit	q.pack	a	b	kg.x1	vol.x1
132103-084	● noir/negro	x1	10	390	500	0.58	mc. 0.088

04 logan-cadre dossier en plastique pour treillis
logan-marco respaldo de plástico para malla

code	finishing	q.kit	q.pack	a	b	kg.x1	vol.x1
132103-085	● noir/negro	x1	20	380	420	0.30	mc. 0.005

and · **10** **11** **12** **07** **26** **09**



for all colour codes, see page 227

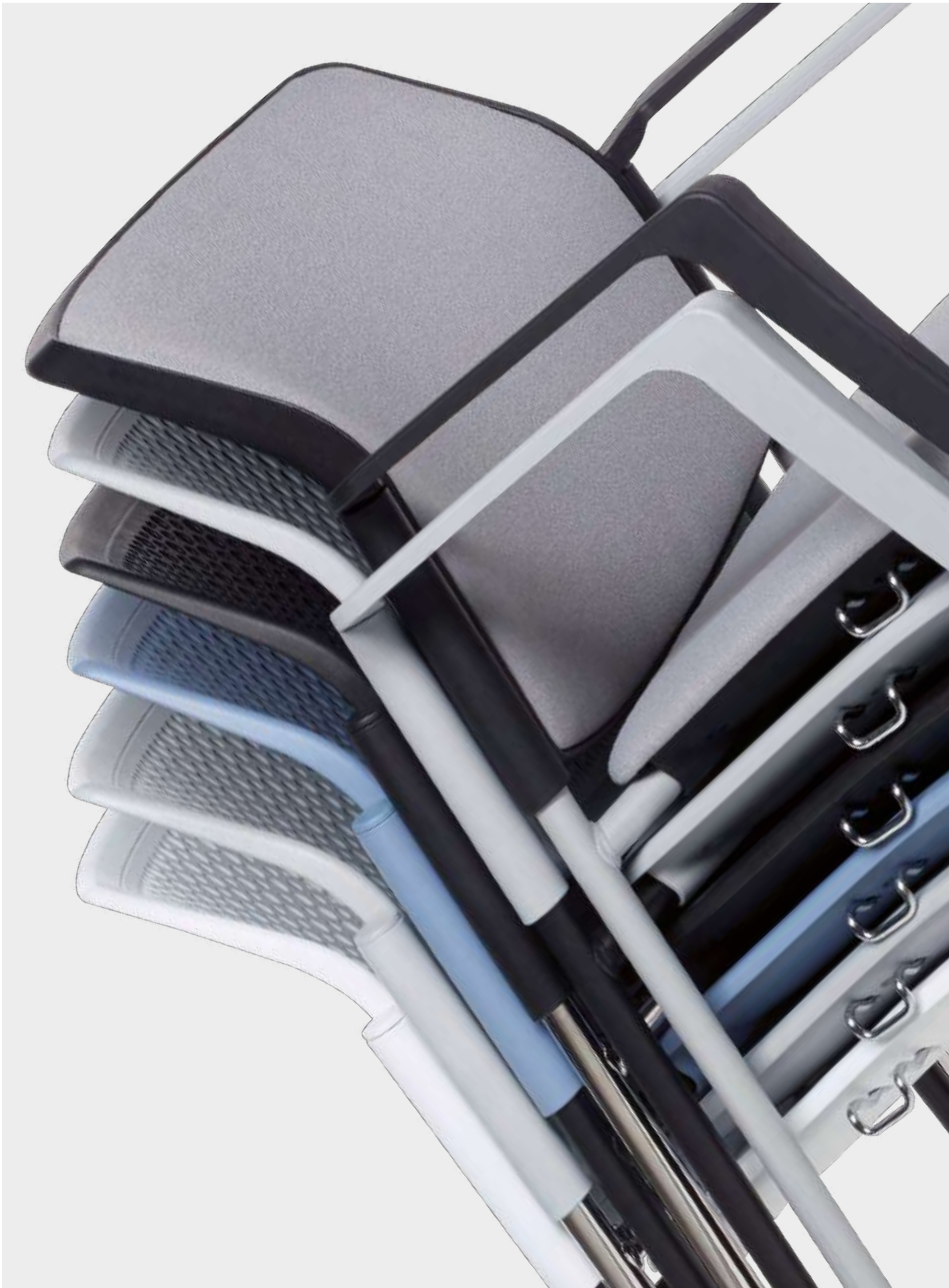



plastic colour codes



18 dossier perforé en plastique
respaldo perforado de plástico

- 132103-083 noir/negro
- 132104-083 gris/gris ral 7040
- 132105-083 blanc/blanco ral 9003
- 132115-083 bleu/azul ral 5014



19 dossier plein en plastique
respaldo lleno de plástico

- 132103-089 noir/negro
- 132104-089 gris/gris ral 7040
- 132105-089 blanc/blanco ral 9003
- 132115-089 bleu/azul ral 5014



06 embout en plastique
tapón de plástico

- 131703-029 noir/negro
- 131704-029 gris/gris ral 7040
- 131705-029 blanc/blanco ral 9003
- 131715-029 bleu/azul ral 5014

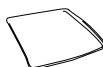

07 siège de vue en plastique
asiento de plástico

- 132203-082 noir/negro
- 132204-082 gris/gris ral 7040
- 132205-082 blanc/blanco ral 9003
- 132215-082 bleu/azul ral 5014



08 renfort d'assise en plastique
parte inferior asiento de plástico

- 132203-080 noir/negro
- 132204-080 gris/gris ral 7040
- 132205-080 blanc/blanco ral 9003
- 132215-080 bleu/azul ral 5014



26 renfort d'assise pl-banquette et pivotant
parte inferior asiento pl-bancada y giratoria

- 132203-081 noir/negro
- 132204-081 gris/gris ral 7040
- 132205-081 blanc/blanco ral 9003
- 132215-081 bleu/azul ral 5014



10 accoudoirs en plastique
brazos de plástico

- 131703-031 noir/negro
- 131704-031 gris/gris ral 7040
- 131705-031 blanc/blanco ral 9003
- 131715-031 bleu/azul ral 5014

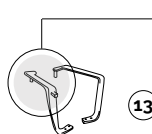

accrochage pour tablette DROITE
enganche para pala DERECHO

13 accoudoirs en plastique pour tablette
brazos de plástico para pala

- 131703-032 L+R writ. tab. hook noir/negro
- 131704-032 L+R writ. tab. hook gris/gris ral 7040
- 131705-032 L+R writ. tab. hook blanc/blanco ral 9003
- 131715-032 L+R writ. tab. hook bleu/azul ral 5014

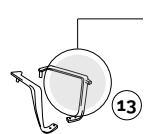

accrochage pour tablette GAUCHE
enganche para pala IZQUIERDO

13 accoudoirs en plastique pour tablette
brazos de plástico para pala

- 131703-033 R+L writ. tab. hook noir/negro
- 131704-033 R+L writ. tab. hook gris/gris ral 7040
- 131705-033 R+L writ. tab. hook blanc/blanco ral 9003
- 131715-033 R+L writ. tab. hook bleu/azul ral 5014

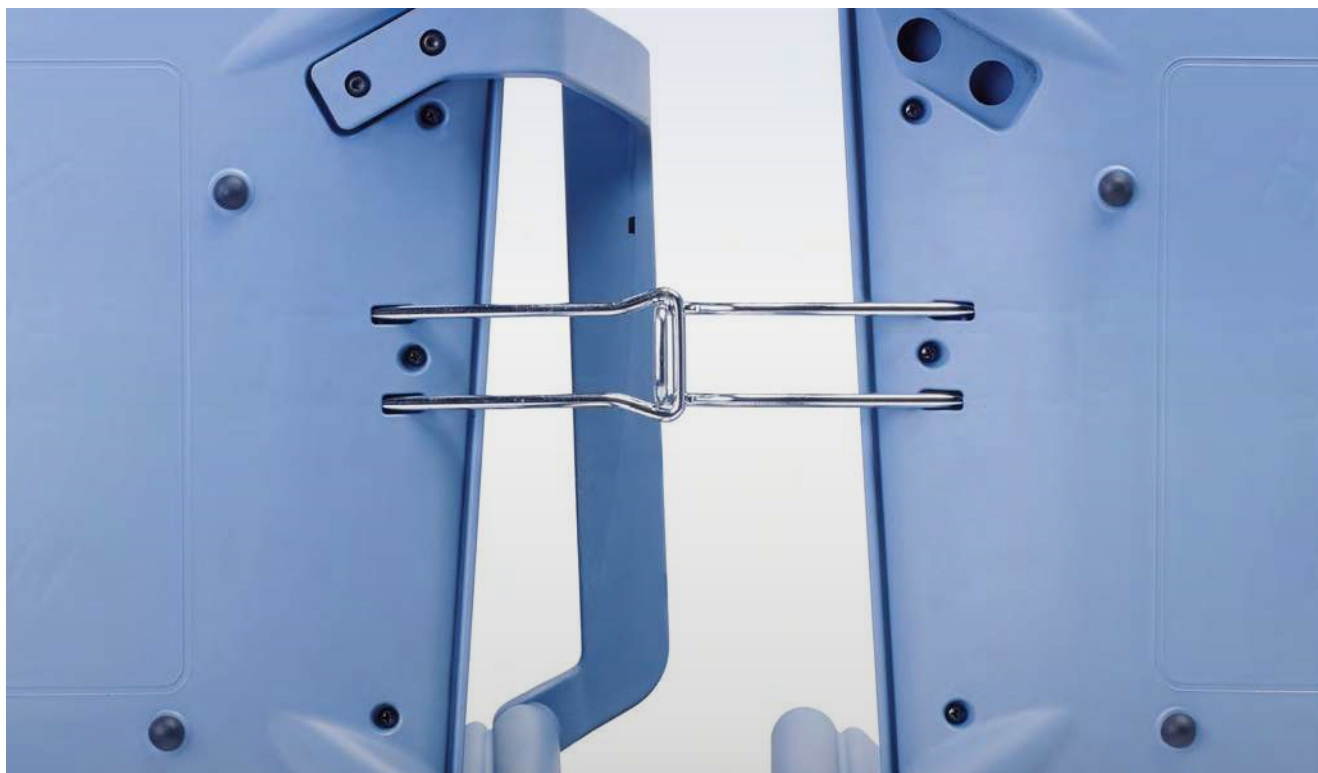



pinko



discover more about
Pinko Collection

Son assise ample et confortable ainsi que la multitude d'options et de versions de châssis et de composants proposés, lui permettent d'être utilisée dans un environnement Bureau et Éducatif.

Mais encore, le banc avec une assise rabattable enrichit un assortiment déjà varié et complet, en faisant de Pinko un modèle parfait pour tout environnement de réception de public.

Con su asiento, amplio y confortable, y un número elevado de opciones y versiones, es ideal para todos los usos en el ambiente de la oficina y educativo.

Todavía hay más, la bancada con asiento abatible completa un surtido variado y completo, por lo que Pinko se adapta también al ambiente de la colectividad.



**trolley
available**

pinko

4-legs

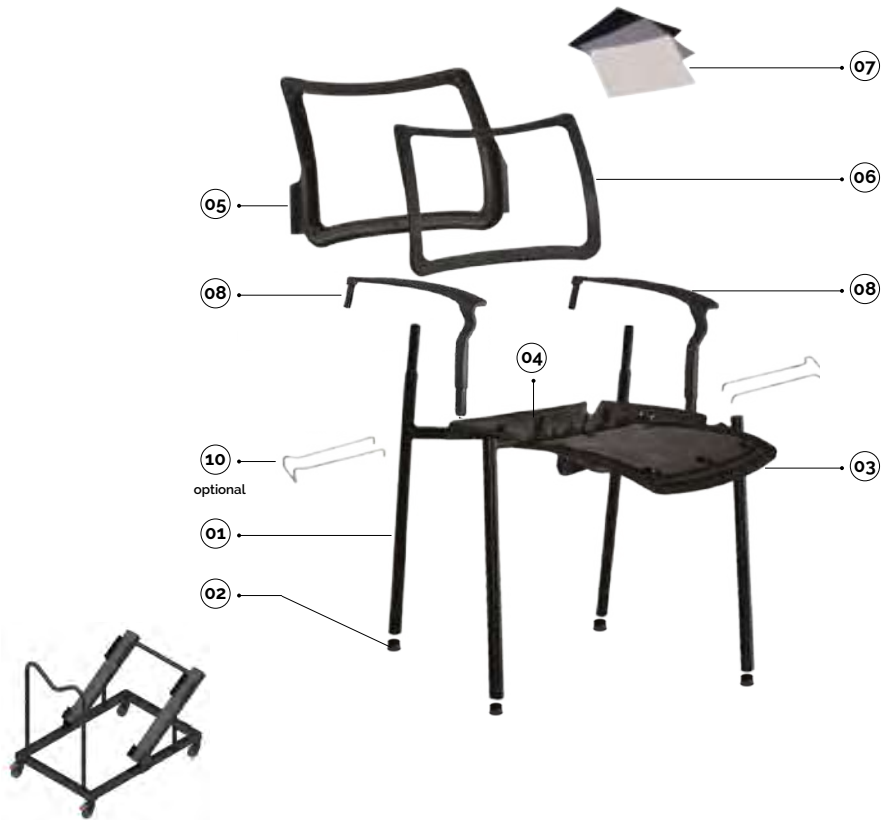

plastic colours

- bleu/azul ral5002
- noir/negro
- gris/gris ral7035

pinko-chariot porte-chaises avec accessoires
pinko-carro para sillas con accesorios

code	finishing	q.kit
110803-340	● noir/negro	x1

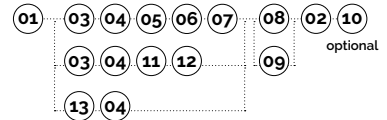

main component sizes

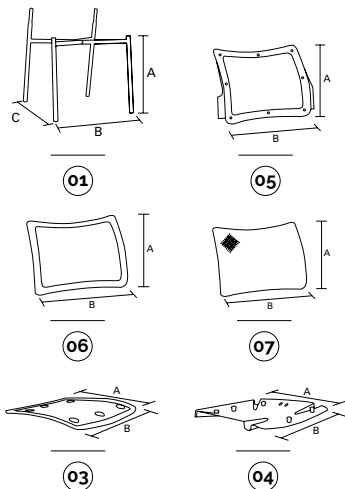

optionals

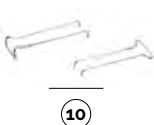

01 pinko-châssis quatre pieds fixe pour accoudoirs sans embouts
pinko-estructura cuatro patas fija para brazos sin tapones

code	finishing	q.kit	q.pack	a	b	c	kg.x1	vol.x1
112603-040	● noir/negro	x1	64	450	530	530	3,20	mc. 0.035
112604-040	● gris/gris	x1	64	450	530	530	3,20	mc. 0.035
112610-040	● chromé/cromado	x1	64	450	530	530	3,20	mc. 0.035

02 pack embouts tête sphérique 025
paquete de tacos con cabeza esférica d.25

code	finishing	q.kit	q.pack
137003-075	● noir/negro	x4	120

03 pinko-siège interne (habillable)
pinko-asiento interno (tapizable)

code	finishing	q.kit	q.pack	a	b	kg.x1	vol.x1
132203-025	● noir/negro	x1	10	465	470	0,73	mc. 0.006

04 pinko-siège externe de plastique
pinko-asiento externo de plástico

code	finishing	q.kit	q.pack	a	b	kg.x1	vol.x1
132203-026	● noir/negro	x1	20	465	470	0,62	mc. 0.007

05 pinko-châssis dossier en plastique pour treillis (portant) + 2 embouts dossier + 2 embouts siège
pinko-estructura respaldo de plástico para malla (portante) + 2 tapones respaldo + 2 tapones asiento

code	finishing	q.kit	q.pack	a	b	kg.x1	vol.x1
132103-027	● noir/negro	x2	20	345	495	0,50	mc. 0.0045

06 pinko-cadre dossier en plastique pour treillis
pinko-marco respaldo de plástico para malla

code	finishing	q.kit	q.pack	a	b	kg.x1	vol.x1
132103-028	● noir/negro	x1	10	345	495	0,35	mc. 0.0057

07 pinko-treillis pour dossier
pinko-malla para respaldo

code	finishing	q.kit	q.pack	a	b	kg.x1	vol.x1
132105-501	○ blanc/blanco	x1	25	460	520	0,14	mc. 0.0057
132103-501	● noir/negro	x1	25	460	520	0,14	mc. 0.0057
132104-501	● gris/gris	x1	25	460	520	0,14	mc. 0.0057

08 pinko-paire d'accoudoirs droit-gauche en plastique
pinko-pareja brazos derecho-izquierdo de plástico

code	finishing	q.kit	q.pack	kg.x1	vol.x1
131703-050	● noir/negro	x1	10	0,66	mc. 0.0037

10 pinko/logan-attelage latéral mâle+female chromé
pinko/logan-enganche lateral macho+hembra cromado

code	finishing	q.kit	q.pack	kg.x1	vol.x1
113410-100	● chromé/cromado	x1	100	0,13	mc. 0.0004

pinko

4-legs/tablet accessories

main component sizes



09



09 pinko-paire d'accoudoirs en plastique avec crochet tablette droit

pinko-pareja brazos de plástico con gancho pala derecho

code	finishing	q.kit	q.pack	kg.x1	vol.x1
131703-051	● noir/negro	x1	10	0,70	mc. 0,0037

TLT
tablet

TLT2
tablet

TLT3
tablet

BEAN
tablet

TL02
tablet

SPT2
mechanism tablet

SPTA
mechanism antipanic



for writing tablet options, see page 404/405

4-legs/seat and backrest options

main component sizes

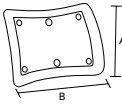

11



11 pinko-dossier interne (habillable)

pinko-respaldo interno (tapizable)

code	finishing	q.kit	q.pack	a	b	kg.x1	vol.x1
132103-025	● noir/negro	x1	20	350	495	0,62	mc. 0,009

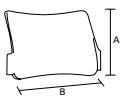

12

12 pinko-dossier externe en plastique + 2 embouts dossier + 2 embouts siège

pinko-respaldo externo de plástico + 2 tapones respaldo + 2 tapones asiento

code	finishing	q.kit	q.pack	a	b	kg.x1	vol.x1
132103-026	● noir/negro	x1	10	350	495	0,25	mc. 0,0045

and · 03 04

main component sizes

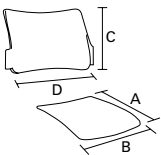

13



13 pinko-siège/dossier en plastique coloré + 2 embouts dossier + 2 embouts siège

pinko-asiento/respaldo de plástico de color base + 2 tapones respaldo + 2 tapones asiento

code	finishing	q.kit	q.pack	a	b	c	d	kg.x1	vol.x1
134015-108	● bleu/azul ral 5002	x1	10	470	465	350	495	1,78	mc. 0,014
134003-108	● noir/negro	x1	10	470	465	350	495	1,78	mc. 0,014
134004-109	● gris/gris ral 7035	x1	10	470	465	350	495	1,78	mc. 0,014

and · 04

pinko

4-legs for castors



plastic colours

- bleu/azul ral5002
- noir/negro
- gris/gris ral7035

main component sizes

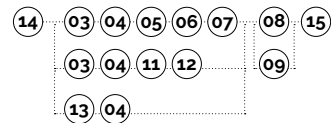
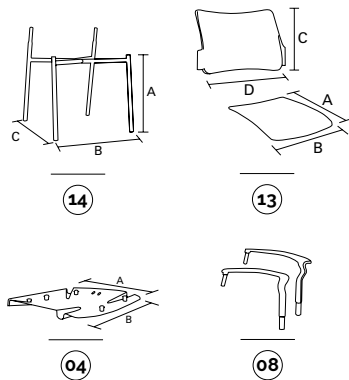

14 pinko-châssis quatre pieds pour roulettes + 4 engrenages pour roulettes pinko-estructura cuatro patas para ruedas + 4 adaptadores para ruedas

code	finishing	q.kit	q.pack	a	b	c	kg.x1	vol.x1
112603-041	● noir/negro	x1	80	390	530	530	3,20	mc. 0.035
112604-041	● gris/gris	x1	80	390	530	530	3,20	mc. 0.035
112610-041	● chromé/cromado	x1	80	390	530	530	3,20	mc. 0.035

15 double roulette ø50 en desmopan tige montée rueda doble d. 50 de desmopan con perno montado

code	finishing	q.kit
134403-003	● noir/negro	x4

13 pinko-siège/dossier en plastique coloré + 2 embouts dossier + 2 embouts siège pinko-asiento/respaldo de plástico de color base + 2 tapones respaldo + 2 tapones asiento

code	finishing	q.kit	q.pack	a	b	c	d	kg.x1	vol.x1
134015-108	● bleu/azul ral 5002	x1	10	470	465	350	495	1,78	mc. 0.014
134003-108	● noir/negro	x1	10	470	465	350	495	1,78	mc. 0.014
134004-109	● gris/gris ral 7035	x1	10	470	465	350	495	1,78	mc. 0.014

04 pinko-siège externe de plastique pinko-asiento externo de plástico

code	finishing	q.kit	q.pack	a	b	kg.x1	vol.x1
132203-026	● noir/negro	x1	20	465	470	0,62	mc. 0.007

08 pinko-paire d'accoudoirs droit-gauche en plastique pinko-pareja brazos derecho-izquierdo de plástico

code	finishing	q.kit	q.pack	kg.x1	vol.x1
131703-050	● noir/negro	x1	10	0,66	mc. 0.0037



pinko-chariot porte-chaises avec accessoires pinko-carro para sillas con accesorios

code	finishing	q.kit
110803-340	● noir/negro	x1

pinko

4-legs for castors/tablet accessories

main component sizes



09



09 pinko-paire d'accoudoirs en plastique avec crochet tablette droit pinko-pareja brazos de plástico con gancho pala derecho

code	finishing	q.kit	q.pack	kg.x1	vol.x1
131703-051	● noir/negro	x1	10	0,70	mc. 0,0037

TLT
tablet

TLT2
tablet

TLT3
tablet

BEAN
tablet

TL02
tablet

SPT2
mechanism tablet

SPTA
mechanism antipanic



for writing tablet options, see page 404/405

4-legs/seat and backrest options

main component sizes

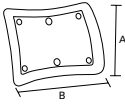

11

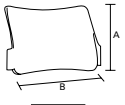

12



11 pinko-dossier interne (habillable) pinko-respaldo interno (tapizable)

code	finishing	q.kit	q.pack	a	b	kg.x1	vol.x1
132103-025	● noir/negro	x1	20	350	495	0,62	mc. 0,009

12 pinko-dossier externe en plastique + 2 embouts dossier + 2 embouts siège pinko-respaldo externo de plástico + 2 tapones respaldo + 2 tapones asiento

code	finishing	q.kit	q.pack	a	b	kg.x1	vol.x1
132103-026	● noir/negro	x1	10	350	495	0,25	mc. 0,0045

and 03 04

main component sizes

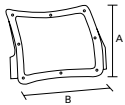

05

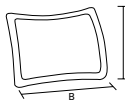

06

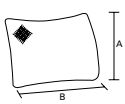

07



05 pinko-châssis dossier en plastique pour treillis (portant) + 2 embouts dossier + 2 embouts siège pinko-estructura respaldo de plástico para malla (portante) + 2 tapones respaldo + 2 tapones asiento

code	finishing	q.kit	q.pack	a	b	kg.x1	vol.x1
132103-027	● noir/negro	x2	20	345	495	0,50	mc. 0,0045

06 pinko-cadre dossier en plastique pour treillis pinko-marco respaldo de plástico para malla

code	finishing	q.kit	q.pack	a	b	kg.x1	vol.x1
132103-028	● noir/negro	x1	10	345	495	0,35	mc. 0,0057

07 pinko-treillis pour dossier pinko-malla para respaldo

code	finishing	q.kit	q.pack	a	b	kg.x1	vol.x1
132105-501	○ blanc/blanco	x1	25	460	520	0,14	mc. 0,0057
132103-501	● noir/negro	x1	25	460	520	0,14	mc. 0,0057
132104-501	● gris/gris	x1	25	460	520	0,14	mc. 0,0057

and 03 04

pinko

slide



plastic colours

- bleu/azul ral5002
- noir/negro
- gris/gris ral7035

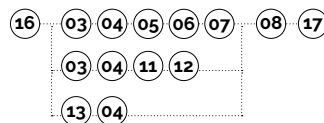

main component sizes

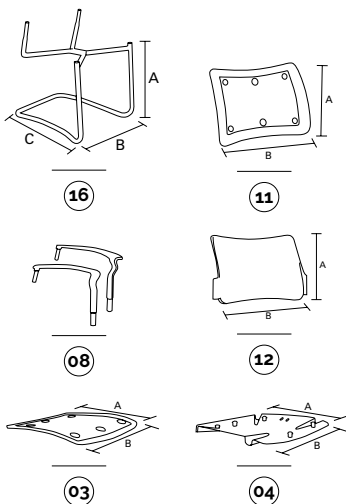

16 pinko-base coulissante en tube asform ø25 embouts exclus
pinko-base patin tubular asform d. 25 tapones excluidos

code	finishing	q.kit	q.pack	a	b	c	kg.x1	vol.x1
110503-093	● noir/negro	x1	40	450	550	550	4,60	mc. 0,06
110504-093	● gris/gris	x1	40	450	550	550	4,60	mc. 0,06
110510-093	● chromé/cromado	x1	40	450	550	550	4,60	mc. 0,06

17 pare-chocs tête bombée ø18
tope cabeza convexa d.18

code	finishing	q.kit
134403-101	● noir/negro	x4

03 pinko-siège interne (habillable)
pinko-asiento interno (tapizable)

code	finishing	q.kit	q.pack	a	b	kg.x1	vol.x1
132203-025	● noir/negro	x1	10	465	470	0,73	mc. 0,006

04 pinko-siège externe de plastique
pinko-asiento externo de plástico

code	finishing	q.kit	q.pack	a	b	kg.x1	vol.x1
132203-026	● noir/negro	x1	20	465	470	0,62	mc. 0,007

11 pinko-dossier interne (habillable)
pinko-respaldo interno (tapizable)

code	finishing	q.kit	q.pack	a	b	kg.x1	vol.x1
132103-025	● noir/negro	x1	20	350	495	0,62	mc. 0,009

12 pinko-dossier externe en plastique + 2 embouts dossier + 2 embouts siège
pinko-respaldo externo de plástico + 2 tapones respaldo + 2 tapones asiento

code	finishing	q.kit	q.pack	a	b	kg.x1	vol.x1
132103-026	● noir/negro	x1	10	350	495	0,25	mc. 0,0045

08 pinko-paire d'accoudoirs droit-gauche en plastique
pinko-pareja brazos derecho-izquierdo de plástico

code	finishing	q.kit	q.pack	kg.x1	vol.x1
131703-050	● noir/negro	x1	10	0,66	mc. 0,0037

pinko

slide/seat and backrest options

main component sizes

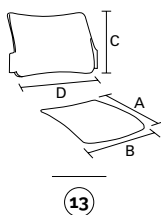

13 pinko-siège/dossier en plastique coloré + 2 embouts dossier + 2 embouts siège
pinko-asiento/respaldo de plástico de color base + 2 tapones respaldo + 2 tapones asiento

code	finishing	q.kit	q.pack	a	b	c	d	kg.x1	vol.x1
134015-108	● bleu/azul ral 5002	x1	10	470	465	350	495	1,78	mc. 0.014
134003-108	● noir/negro	x1	10	470	465	350	495	1,78	mc. 0.014
134004-109	● gris/gris ral 7035	x1	10	470	465	350	495	1,78	mc. 0.014

and **04**

main component sizes

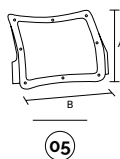

05 pinko-châssis dossier en plastique pour treillis (portant) + 2 embouts dossier + 2 embouts siège
pinko-estructura respaldo de plástico para malla (portante) + 2 tapones respaldo + 2 tapones asiento

code	finishing	q.kit	q.pack	a	b	kg.x1	vol.x1
132103-027	● noir/negro	x2	20	345	495	0,50	mc. 0.0045

06 pinko-cadre dossier en plastique pour treillis
pinko-marco respaldo de plástico para malla

code	finishing	q.kit	q.pack	a	b	kg.x1	vol.x1
132103-028	● noir/negro	x1	10	345	495	0,35	mc. 0.0057

07 pinko-treillis pour dossier
pinko-malla para respaldo

code	finishing	q.kit	q.pack	a	b	kg.x1	vol.x1
132105-501	○ blanc/blanco	x1	25	460	520	0,14	mc. 0.0057
132103-501	● noir/negro	x1	25	460	520	0,14	mc. 0.0057
132104-501	● gris/gris	x1	25	460	520	0,14	mc. 0.0057

and **03** **04**

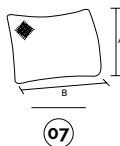
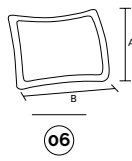

pinko

swivel



plastic colours

- bleu/azul ral5002
- noir/negro
- gris/gris ral7035

main component sizes

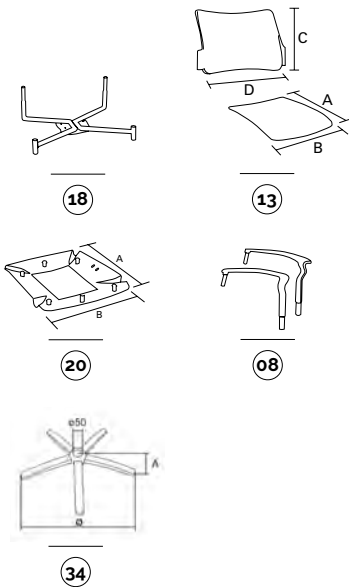

optionals

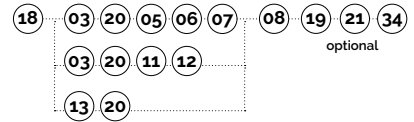
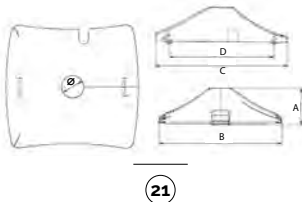

18 pinko-châssis pour pivotant commande au gaz sans embouts
pinko-estructura para versión giratoria accionamiento con gas sin tapones

code	finishing	q.kit	q.pack	kg.x1	vol.x1
112603-045	● noir/negro	x1	80	2,60	mc. 0,005
112604-045	● gris/gris	x1	80	2,60	mc. 0,005

19 embouts couvre-tête à ailettes d.25 noir
tapón embellecedor d.25 negro

code	finishing	q.kit
134103-250	● noir/negro	x2

13 pinko-siège/dossier en plastique coloré + 2 embouts dossier + 2 embouts siège
pinko-asiento/respaldo de plástico de color base + 2 tapones respaldo + 2 tapones asiento

code	finishing	q.kit	q.pack	a	b	c	d	kg.x1	vol.x1
134015-108	● bleu/azul ral 5002	x1	10	470	465	350	495	1,78	mc. 0,014
134003-108	● noir/negro	x1	10	470	465	350	495	1,78	mc. 0,014
134004-109	● gris/gris ral 7035	x1	10	470	465	350	495	1,78	mc. 0,014

20 pinko-siège externe plastique pour pivotant et banquette
pinko-asiento externo de plástico para versión giratoria y bancada

code	finishing	q.kit	q.pack	a	b	kg.x1	vol.x1
132203-027	● noir/negro	x1	20	465	470	0,60	mc. 0,007

08 pinko-paire d'accoudoirs droit-gauche en plastique
pinko-pareja brazos derecho-izquierdo de plástico

code	finishing	q.kit	q.pack	kg.x1	vol.x1
131703-050	● noir/negro	x1	10	0,66	mc. 0,0037

21 cpg-couverture en plastique pour châssis pivotant
cpg-cubierta de plástico para estructura versión giratoria

code	finishing	q.kit	q.pack	a	b	c	d	ø	kg.x1	vol.x1
130903-000	● noir/negro	x1	50	60	200	210	167	36	0,1	mc. 0,0015

34 b40-base en métal avec cache-soudure
b40-base de metal con embellecedor soldadura

code	finishing	q.kit	q.pack	a	ø	kg.x1	vol.x1
110210-027	● chromé/cromado	x1	5	60	640	2,85	mc. 0,014

CPG
plastic cover for swivel frame



pinko

swivel/seat and backrest options

main component sizes

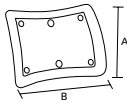

11

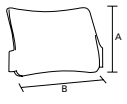

12



11 pinko-dossier interne (habillable)
pinko-respaldo interno (tapizable)

code	finishing	q.kit	q.pack	a	b	kg.x1	vol.x1
132103-025	● noir/negro	x1	20	350	495	0,62	mc. 0.009

12 pinko-dossier externe en plastique + 2 embouts dossier + 2 embouts siège
pinko-respaldo externo de plástico + 2 tapones respaldo + 2 tapones asiento

code	finishing	q.kit	q.pack	a	b	kg.x1	vol.x1
132103-026	● noir/negro	x1	10	350	495	0,25	mc. 0.0045

and **03** **20**

main component sizes

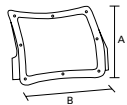

05

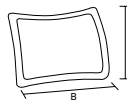

06

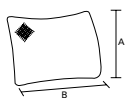

07



05 pinko-châssis dossier en plastique pour treillis (portant) + 2 embouts dossier + 2 embouts siège
pinko-estructura respaldo de plástico para malla (portante) + 2 tapones respaldo + 2 tapones asiento

code	finishing	q.kit	q.pack	a	b	kg.x1	vol.x1
132103-027	● noir/negro	x2	20	345	495	0,50	mc. 0.0045

06 pinko-cadre dossier en plastique pour treillis
pinko-marco respaldo de plástico para malla

code	finishing	q.kit	q.pack	a	b	kg.x1	vol.x1
132103-028	● noir/negro	x1	10	345	495	0,35	mc. 0.0057

07 pinko-treillis pour dossier
pinko-malla para respaldo

code	finishing	q.kit	q.pack	a	b	kg.x1	vol.x1
132105-501	○ blanc/blanco	x1	25	460	520	0,14	mc. 0.0057
132103-501	● noir/negro	x1	25	460	520	0,14	mc. 0.0057
132104-501	● gris/gris	x1	25	460	520	0,14	mc. 0.0057

and **03** **20**

pinko

bench



plastic colours

- bleu/azul ral5002
- noir/negro
- gris/gris ral7035

main component sizes

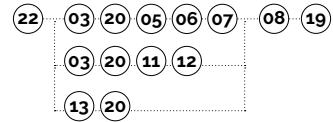
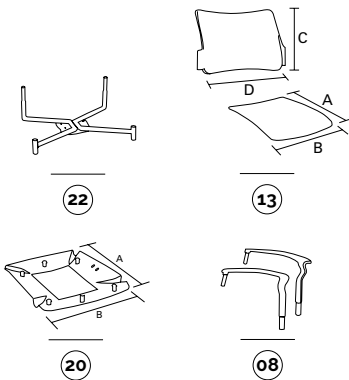

22 pinko-structure pour banquette sans embouts
pinko-estructura bancada sin tapones

code	finishing	q.kit	q.pack	kg.x1	vol.x1
110703-072	● noir/negro	x1	80	2,50	mc. 0.005
110704-072	● gris/gris	x1	80	2,50	mc. 0.005

19 embouts couvre-tête à ailettes d.25 noir
tapón embellecedor d.25 negro

code	finishing	q.kit
134103-250	● noir/negro	x2

13 pinko-siège/dossier en plastique coloré + 2 embouts dossier + 2 embouts siège
pinko-asiento/respaldo de plástico de color base + 2 tapones respaldo + 2 tapones asiento

code	finishing	q.kit	q.pack	a	b	c	d	kg.x1	vol.x1
134015-108	● bleu/azul ral 5002	x1	10	470	465	350	495	1,78	mc. 0.014
134003-108	● noir/negro	x1	10	470	465	350	495	1,78	mc. 0.014
134004-109	● gris/gris ral 7035	x1	10	470	465	350	495	1,78	mc. 0.014

20 pinko-siège externe plastique pour pivotant et banquette
pinko-asiento externo de plástico para versión giratoria y bancada

code	finishing	q.kit	q.pack	a	b	kg.x1	vol.x1
132203-027	● noir/negro	x1	20	465	470	0,60	mc. 0.007

08 pinko-paire d'accoudoirs droit-gauche en plastique
pinko-pareja brazos derecho-izquierdo de plástico

code	finishing	q.kit	q.pack	kg.x1	vol.x1
131703-050	● noir/negro	x1	10	0,66	mc. 0.0037

for the bench components, see page 417

optionals

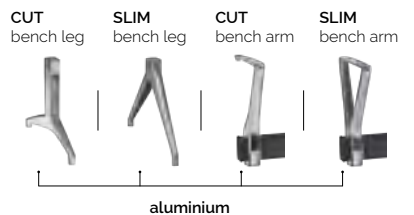
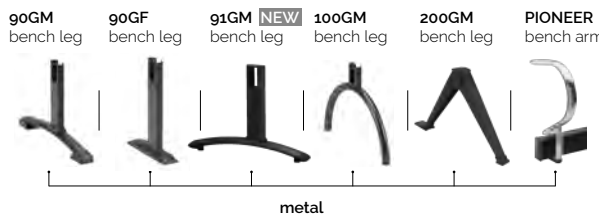

pinko

bench/seat and backrest options

main component sizes

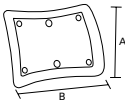

11

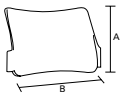

12



11 pinko-dossier interne (habillable)
pinko-respaldo interno (tapizable)

code	finishing	q.kit	q.pack	a	b	kg.x1	vol.x1
132103-025	● noir/negro	x1	20	350	495	0,62	mc. 0.009

12 pinko-dossier externe en plastique + 2 embouts dossier + 2 embouts siège
pinko-respaldo externo de plástico + 2 tapones respaldo + 2 tapones asiento

code	finishing	q.kit	q.pack	a	b	kg.x1	vol.x1
132103-026	● noir/negro	x1	10	350	495	0,25	mc. 0.0045

and **03** **20**

main component sizes

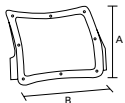

05

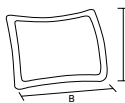

06

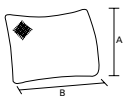

07



05 pinko-châssis dossier en plastique pour treillis (portant) + 2 embouts dossier + 2 embouts siège
pinko-estructura respaldo de plástico para malla (portante) + 2 tapones respaldo + 2 tapones asiento

code	finishing	q.kit	q.pack	a	b	kg.x1	vol.x1
132103-027	● noir/negro	x2	20	345	495	0,50	mc. 0.0045

06 pinko-cadre dossier en plastique pour treillis
pinko-marco respaldo de plástico para malla

code	finishing	q.kit	q.pack	a	b	kg.x1	vol.x1
132103-028	● noir/negro	x1	10	345	495	0,35	mc. 0.0057

07 pinko-treillis pour dossier
pinko-malla para respaldo

code	finishing	q.kit	q.pack	a	b	kg.x1	vol.x1
132105-501	○ blanc/blanco	x1	25	460	520	0,14	mc. 0.0057
132103-501	● noir/negro	x1	25	460	520	0,14	mc. 0.0057
132104-501	● gris/gris	x1	25	460	520	0,14	mc. 0.0057

and **03** **20**

pinko

folding bench

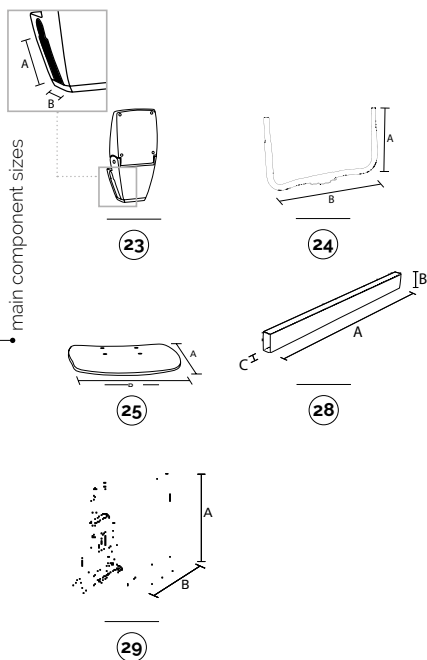
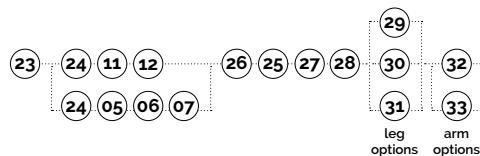

23 siton-mécanisme banquette rabattable en aluminium poli siton-mecanismo bancada abatible de aluminio brillante

code	finishing	q.kit	q.pack	a	b	kg.x1	vol.x1
110704-180	● aluminium/aluminio	x1	4	80	40	2,81	mc. 0,007

24 pinko-châssis dossier en «u» pour banquette rabattable pinko-estructura respaldo en u para bancada abatible

code	finishing	q.kit	q.pack	a	b	kg.x1	vol.x1
110703-071	● noir/negro	x1	15	300	490	1,40	mc. 0,003
110704-182	● gris/gris	x1	15	300	490	1,40	mc. 0,003

25 siton-assise banquette rabattable en bois à revêtir siton-asiento bancada abatible de madera tapizable

code	finishing	q.kit	q.pack	a	b	kg.x1	vol.x1
122207-003	● brut/crudo	x1	10	420	410	1,30	mc. 0,007

26 vis tcei m5x16 brunie noire (vis pour fixation châssis dossier en tube) tornillo tcei m5x16 bruñido negro (tornillo para fijación estructura respaldo tubular)

code	finishing	q.kit
117703-160	● noir/negro	x4

27 vis tcei m6x20 zinguée (vis pour fixation siège) tornillo tcei m6x20 galvanizado (tornillo para fijación asiento)

code	finishing	q.kit
117711-198	● zinguée/galvanizado	x4

28 90t(03) poutre pour banquette 80x40 90t(03) viga para bancada 80x40

code	finishing		q.kit	q.pack	a	b	c	kg.x1	vol.x1
110703-190	● noir/negro	2 places / 2 asientos	x1	1	1160	80	40	3,20	mc. 0,0045
110704-190	● gris/gris	2 places / 2 asientos	x1	1	1160	80	40	3,20	mc. 0,0045
110703-191	● noir/negro	3 places / 3 asientos	x1	1	1710	80	40	4,71	mc. 0,005
110704-191	● gris/gris	3 places / 3 asientos	x1	1	1710	80	40	4,71	mc. 0,005
110703-192	● noir/negro	4 places / 4 asientos	x1	1	2260	80	40	6,22	mc. 0,0085
110704-192	● gris/gris	4 places / 4 asientos	x1	1	2260	80	40	6,22	mc. 0,0085
110703-193	● noir/negro	5 places / 5 asientos	x1	1	2800	80	40	7,72	mc. 0,001
110704-197	● gris/gris	5 places / 5 asientos	x1	1	2800	80	40	7,72	mc. 0,001

29 90gf(02)-ped fixe pour banquette avec accessoires 90gf(02)-pata fija para bancada con accesorios

code	finishing	q.kit	q.pack	a	b	kg.x1	vol.x1
110703-122	● noir/negro	x2	2	320	310	1,80	mc. 0,0012
110704-107	● gris/gris	x2	2	320	310	1,80	mc. 0,0012

for the components below, see previous pages

for the bench components, see page 417

pinko

folding bench/tablet accessories



for writing tablet options, see page 404/405

folding bench/seat and backrest option

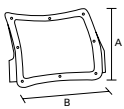

05

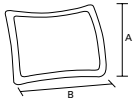

06

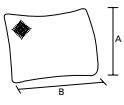

07



- 05 pinko-châssis dossier en plastique pour treillis (portant) + 2 embouts dossier + 2 embouts siège
pinko-estructura respaldo de plástico para malla (portante) + 2 tapones respaldo + 2 tapones asiento

code	finishing	q.kit	q.pack	a	b	kg.x1	vol.x1
132103-027	● noir/negro	x2	20	345	495	0,50	mc. 0.0045

- 06 pinko-cadre dossier en plastique pour treillis
pinko-marco respaldo de plástico para malla

code	finishing	q.kit	q.pack	a	b	kg.x1	vol.x1
132103-028	● noir/negro	x1	10	345	495	0,35	mc. 0.0057

- 07 pinko-treillis pour dossier
pinko-malla para respaldo

code	finishing	q.kit	q.pack	a	b	kg.x1	vol.x1
132105-501	○ blanc/blanco	x1	25	460	520	0,14	mc. 0.0057
132103-501	● noir/negro	x1	25	460	520	0,14	mc. 0.0057
132104-501	● gris/gris	x1	25	460	520	0,14	mc. 0.0057

and 24 26 25 27

folding bench/leg and armrest options

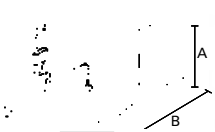

05



- 30 90gm(02)-pied mobile pour banquette avec accessoires
90gm(02)-pata móvil para bancada con accesorios

code	finishing	q.kit	q.pack	a	b	kg.x1	vol.x1
110703-120	● noir/negro	x2	2	320	600	2,70	mc. 0.0012
110704-099	● gris/gris	x2	2	320	600	2,70	mc. 0.0012
110710-007	● chromé/cromado	x2	2	320	600	2,70	mc. 0.0012

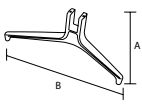

05



- 31 siton(ga02)-pied long en aluminium pour banquette
siton(ga02)-pata larga de aluminio para bancada

code	finishing	q.kit	q.pack	a	b	kg.x1	vol.x1
110704-171	● aluminium/aluminio	x2	5	305	643	2,80	mc. 0.014

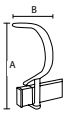

05



- 32 siton-accoudoir elliptique pour banquette avec accessoires
siton-brazo elíptico para bancada con accesorios

code	finishing	q.kit	q.pack	a	b	kg.x1	vol.x1
111710-020	● chromé/cromado	x1	5	370	340	1,70	mc. 0.015
111703-019	● noir/negro	x1	5	370	340	1,70	mc. 0.015

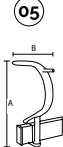

05



- 33 siton.p-accoudoir elliptique pour banquette avec attelage porte tablette et accessoires
siton.p-brazo elíptico para bancada con gancho para pala con accesorios

code	finishing	q.kit	q.pack	a	b	kg.x1	vol.x1
111710-017	● chromé/cromado	x1	5	370	340	1,70	mc. 0.015
111703-017	● noir/negro	x1	5	370	340	1,70	mc. 0.015



X3



discover more about
X3 Collection

Une assise en plastique proposée dans 4 couleurs, que se caractérise par son design distinctif.

Elle se présente dans différentes versions: avec un dossier en plastique plein ou ajouré, un dossier en résille, des panneaux de chaises et des dossiers en plastique à tapisser.

Il est par ailleurs possible de choisir parmi un large choix d'assortiment de châssis, en offrant ainsi plusieurs solutions adaptées au bureau et au public, car ce modèle est facilement empilable.

Un asiento de plástico, disponible en 4 colores, y caracterizado por un diseño distintivo.

Existe en varias versiones: respaldo de plástico macizo o perforado, respaldo de malla, paneles tapizables para asiento y respaldo de plástico.

Asimismo, se puede elegir entre un surtido amplio de estructuras, que ofrece soluciones diferentes para los ambientes de la oficina y de la colectividad, también por su cómoda apilabilidad.

Plus

• Certification ANSI/BIFMA X5.1.

• *Certificación ANSI/BIFMA X5.1.*



certified
product

X3 slide



plastic colours

- gris/gris ral 7003
- noir/negro
- rouge/rojo 527
- blanc/blanco ral 1013

x3-chariot porte-chaises avec accessoires
x3-carro para sillas con accesorios

code	finishing	q.kit	kg.x1
110803-346	● noir/negro	x1	10,50

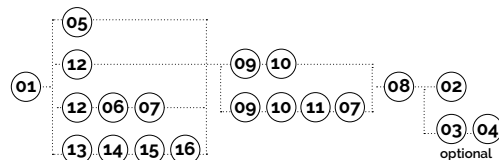

main component sizes

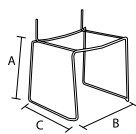

01

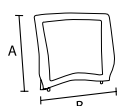

05



09



10



02



03



04

optionals

01 x3-base coulissante tige d.12
x3-base patin de varilla d.12

code	finishing	q.kit	q.pack	a	b	c	kg.x1	vol.x1
113410-062	● chromé/cromado	x1	60	450	530	505	4,20	mc. 0.03

02 btf-kit pieds
btf-kit pies

code	finishing	q.kit	q.pack	kg.x1
134306-001	○ neutre/neutro	x1	100	0,05

03 btf-kit pieds avec crochets
btf-kit pies con ganchos

code	finishing	q.kit	q.pack	kg.x1
134306-002	○ neutre/neutro	x1	100	0,06

04 pptf-embout pour fixation au sol
pptf-tapón para fijación en el pavimento

code	finishing	q.kit	q.pack	kg.x1
134306-003	○ neutre/neutro	x2	100	0,03

05 x3-dossier coloré en plastique plein
x3-respaldo de color de plástico lleno

code	finishing	q.kit	q.pack	a	b	kg.x1	vol.x1
132103-090	● noir/negro	x1	10	400	460	0,90	mc. 0.008

08 x3-adaptateur pour dossier en plastique
x3-adaptador para respaldo de plástico

code	finishing	q.kit	q.pack	kg.x1	vol.x1
132103-009	● noir/negro	x2	200	0,019	mc. 0.0001

09 x3-siège coloré en plastique pour châssis coulissant
x3-asiento de color de plástico para estructura patin

code	finishing	q.kit	q.pack	a	b	kg.x1	vol.x1
132203-019	● noir/negro	x1	10	450	460	1,20	mc. 0.015

10 x3-renfort d'assise en plastique coloré
x3-partie inferior asiento de color base de plástico

code	finishing	q.kit	q.pack	a	b	kg.x1	vol.x1
132203-009	● noir/negro	x1	20	450	460	0,73	mc. 0.007



for all colour codes, see page 259

X3

slide/backrest and seat options

main component sizes

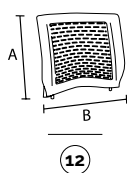

12



CERTIFIED BY
BIFMA

- 12** x3-dossier coloré en plastique à trous
x3-respaldo de color base de plástico perforado

code	finishing	q.kit	q.pack	a	b	kg.x1	vol.x1
132102-019	● rouge/rojo 527	x1	10	400	460	0,90	mc. 0.008

and · **09** **10**

main component sizes

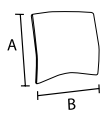

06



- 06** x3-panneau dossier à revêtir en plastique
x3-panel respaldo tapizable de plástico

code	finishing	q.kit	q.pack	a	b	kg.x1	vol.x1
132103-008	● noir/negro	x1	20	350	385	0,50	mc. 0.003

- 11** x3-panneau assise à revêtir en plastique
x3-galleta asiento tapizable de plástico

code	finishing	q.kit	q.pack	a	b	kg.x1	vol.x1
132203-003	● noir/negro	x1	20	400	410	0,60	mc. 0.003

- 07** vis hilo tb+ 5x12 cimentée brunie noire
tornillo hilo tb+ 5x12 cementado bruñido negro

code	finishing	q.kit seat	q.kit back
117803-154	● noir/negro	x8	x6

and · **12** **09** **10**

main component sizes

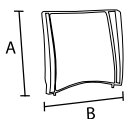

13



- 13** x3-dossier pour treillis noir en plastique
x3-respaldo para malla negro base de plástico

code	finishing	q.kit	q.pack	a	b	kg.x1	vol.x1
132103-014	● noir/negro	x1	10	400	460	0,60	mc. 0.008

- 14** x3-bandes a+b pour dossier treillis noir
x3-listones a+b para respaldo malla negros base

code	finishing	q.kit	q.pack	kg.x1	vol.x1
132103-013	● noir/negro	x1	100	0,21	mc. 0.0004

- 15** x3-treillis pour dossier
x3-malla para respaldo

code	finishing	q.kit	q.pack	a	b	kg.x1	vol.x1
132103-029	● noir/negro	x1	50	400	460	0,14	mc. 0.0057

- 16** vis médium tsp+ ø3,5x10 brunie noire (pour fixer dossier treillis)
tornillo para panel de aglomerado tsp+ d.3,5x10 bruñido negro (para fijar respaldo malla)

code	finishing	q.kit
117803-105	● noir/negro	x8

and · **09** **10** **11** **07**

X3

slide w/writing tablet

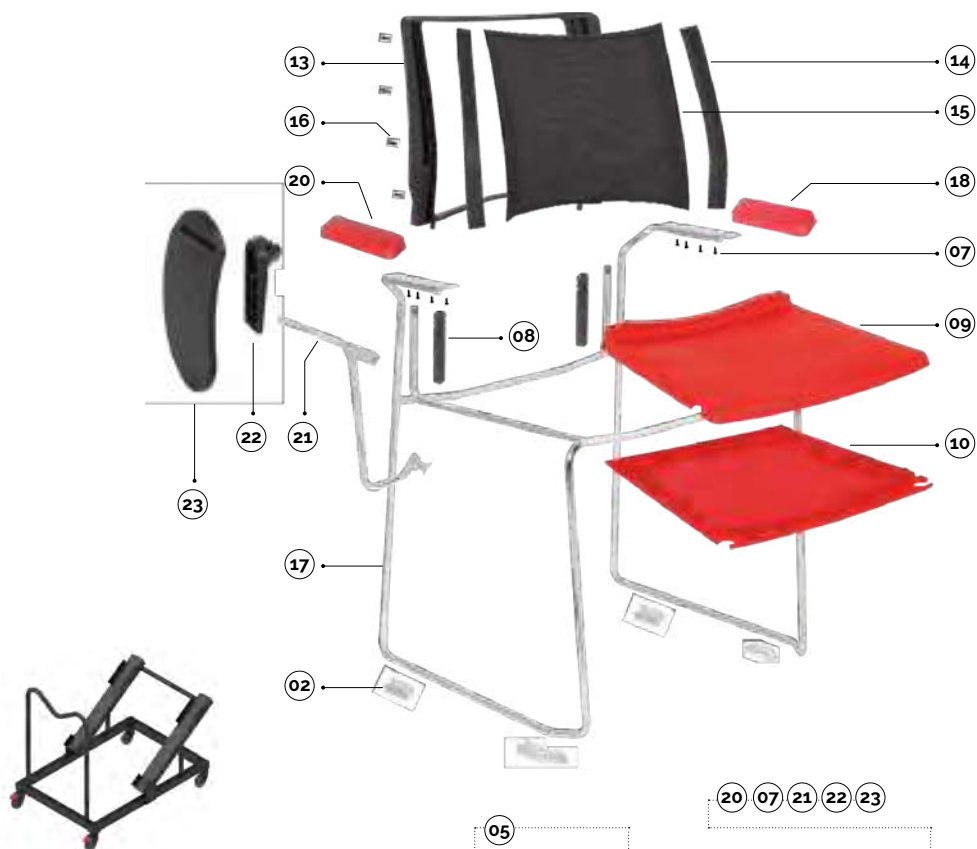

plastic colours

- gris/gris ral 7003
- noir/negro
- rouge/rojo 527
- blanc/blanco ral 1013

x3-chariot porte-chaises avec accessoires
x3-carro para sillas con accesorios

code	finishing	q.kit	kg.x1
110803-346	● noir/negro	x1	10,50

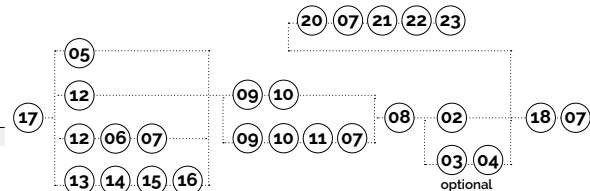

main component sizes

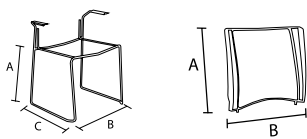

17 **13**

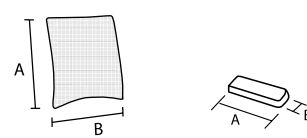

15 **18**



02 **03** **04**

optionals

17	x3-châssis coulissant tige d.12 avec accoudoirs x3-estructura patin de varilla d. 12 con brazos	code	finishing	q.kit	q.pack	a	b	c	kg.x1	vol.x1
		113410-061	● chromé/cromado	x1	60	450	530	505	5,00	mc. 0.035
13	x3-dossier pour treillis noir en plastique x3-respaldo para malla negro base de plástico	code	finishing	q.kit	q.pack	a	b	kg.x1	vol.x1	
		132103-014	● noir/negro	x1	10	400	460	0,60	mc. 0.008	
14	x3-bandes a+b pour dossier treillis noir x3-listones a+b para respaldo malla negro base	code	finishing	q.kit	q.pack	kg.x1	vol.x1			
		132103-013	● noir/negro	x1	100	0,21	mc. 0.0004			
15	x3-treillis pour dossier x3-malla para respaldo	code	finishing	q.kit	q.pack	a	b	kg.x1	vol.x1	
		132103-029	● noir/negro	x1	50	400	460	0,14	mc. 0.0057	
16	vis médium tsp* ø3,5x10 brunie noire (pour fixer dossier treillis) tornillo para panel de aglomerado tsp* d.3,5x10 bruñido negro (para fijar respaldo malla)	code	finishing	q.kit						
		117803-105	● noir/negro	x8						
18	x3-accoudoir plastique coloré pour châssis fil x3-brazo de plástico de color para estructura patin de varilla	code	finishing	q.kit	q.pack	a	b	kg.x1	vol.x1	
		131702-019	● rouge/rojo	527	x2	40	175	55	0,10	mc. 0.0004
07	vis hilo tb* 5x12 cimentée brunie noire tornillo hilo tb* 5x12 cementado bruñido negro	code	finishing	q.kit seat	q.kit back					
		117803-154	● noir/negro	x8	x6					

for the components below, see previous pages

02 03 04 08 09 10



for all colour codes, see page 259

X3

slide/tablet accessories

main component sizes

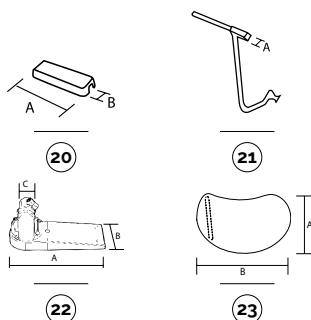

20 X3-accoudoir plastique coloré pour châssis fil avec tablette

X3-brazo de plástico de color para estructura patin de varilla con pala

code	finishing		q.kit	q.pack	a	b	kg.x1	vol.x1
131702-018	● rouge/rojo	527	x2	40	175	55	0,10	mc. 0,0004

21 X3-support tablette pour coulisse + vis

X3-soporte pala para patin + tornillos

code	finishing		q.kit	q.pack		kg.x1	vol.x1
111703-044	● noir/negro	droite/derecha-coulisse/patin	x1	10	15x15	0,60	mc. 0,002
111703-047	● noir/negro	gauche/izquierda-coulisse/patin	x1	10	15x15	0,60	mc. 0,002
111710-044	● chromé/cromado	droite/derecha-coulisse/patin	x1	10	15x15	0,60	mc. 0,002
111710-047	● chromé/cromado	gauche/izquierda-coulisse/patin	x1	10	15x15	0,60	mc. 0,002

22 spt2-rotule pour tablette en plastique

spt2-articulación para pala de plástico

code	finishing		q.kit	q.pack	a	b	c	kg.x1	vol.x1
134003-039	● noir/negro		x1	20	180	66	15x15	0,35	mc. 0,0006

23 bean-tablette en thermoplastique épaisseur 16 mm

bean-pala de termoplástico grosor 16 mm

code	finishing		q.kit	q.pack	a	b	kg.x1	vol.x1
134003-044	● noir/negro		x1	20	235	370	0,40	mc. 0,002



for writing tablet options, see page 404/405

slide w/armrests/backrest and seat options

main component sizes

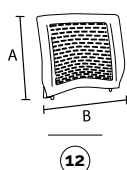

12 X3-dossier coloré en plastique à trous

X3-respaldo de color base de plástico perforado

code	finishing		q.kit	q.pack	a	b	kg.x1	vol.x1
132102-019	● rouge/rojo	527	x1	10	400	460	0,90	mc. 0,008

and · (09) (10)

main component sizes

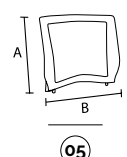

05 X3-dossier coloré en plastique plein

X3-respaldo de color de plástico lleno

code	finishing		q.kit	q.pack	a	b	kg.x1	vol.x1
132103-090	● noir/negro		x1	10	400	460	0,90	mc. 0,008

and · (09) (10)

main component sizes

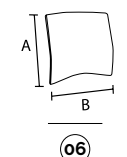

06 X3-panneau dossier à revêtir en plastique

X3-panel respaldo tapizable de plástico

code	finishing		q.kit	q.pack	a	b	kg.x1	vol.x1
132103-008	● noir/negro		x1	20	350	385	0,50	mc. 0,003

11 X3-panneau assise à revêtir en plastique

X3-galleta asiento tapizable de plástico

code	finishing		q.kit	q.pack	a	b	kg.x1	vol.x1
132203-003	● noir/negro		x1	20	400	410	0,60	mc. 0,003

07 vis hilo tb+ 5x12 cimentée brunie noire

tornillo hilo tb+ 5x12 cementado bruniado negro

code	finishing		q.kit seat	q.kit back
117803-154	● noir/negro		x8	x6

and · (12) (09) (10)

X3

4-legs



plastic colours

- gris/gris ral 7003
- noir/negro
- rouge/rojo 527
- blanc/blanco ral 1013

x3-chaîris porte-chaises avec accessoires
x3-carro para sillas con accesorios

code	finishing	q.kit	kg.x1
110803-346	● noir/negro	x1	10,50

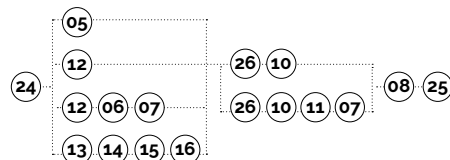

main component sizes

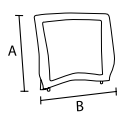
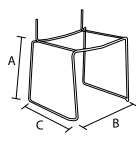

24

05

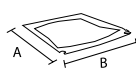

26

10

24 x3-châssis 4 pieds d.18
x3-estructura 4 patas d.18

code	finishing	q.kit	q.pack	a	b	c	kg.x1	vol.x1
112703-050	● noir/negro	x1	60	455	465	550	2,20	mc. 0.03
112704-050	● gris/gris	x1	60	455	465	550	2,20	mc. 0.03
112710-050	● chromé/cromado	x1	60	455	465	550	2,20	mc. 0.03

25 pack embouts ronds d.18 noirs
paquete de tacos redondos d.18 negros

code	finishing	q.kit	q.pack
137003-072	● noir/negro	x4	200

05 x3-dossier coloré en plastique plein
x3-respaldo de color de plástico lleno

code	finishing	q.kit	q.pack	a	b	kg.x1	vol.x1
132103-090	● noir/negro	x1	10	400	460	0,90	mc. 0,008

08 x3-adaptateur pour dossier en plastique
x3-adaptador para respaldo de plástico

code	finishing	q.kit	q.pack	kg.x1	vol.x1
132103-009	● noir/negro	x2	200	0,019	mc. 0,0001

26 x3-siège coloré en plastique pour châssis 4 pieds
x3-asiento de color base de plástico para estructura 4 patas

code	finishing	q.kit	q.pack	a	b	kg.x1	vol.x1
132203-018	● noir/negro	x1	10	450	460	1,20	mc. 0,015

10 x3-renfort d'assise en plastique coloré
x3-parte inferior asiento de color base de plástico

code	finishing	q.kit	q.pack	a	b	kg.x1	vol.x1
132203-009	● noir/negro	x1	20	450	460	0,73	mc. 0,007



for all colour codes, see page 259

X3

4-legs/backrest and seat options

main component sizes

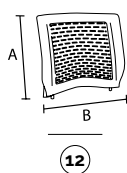

- 12** x3-dossier coloré en plastique à trous
x3-respaldo de color base de plástico perforado

code	finishing	q.kit	q.pack	a	b	kg.x1	vol.x1
132102-019	● rouge/rojo 527	x1	10	400	460	0,90	mc. 0.008

and · **26** **10**

main component sizes

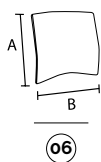

- 06** x3-panneau dossier à revêtir en plastique
x3-panel respaldo tapizable de plástico

code	finishing	q.kit	q.pack	a	b	kg.x1	vol.x1
132103-008	● noir/negro	x1	20	350	385	0,50	mc. 0.003

- 11** x3-panneau assise à revêtir en plastique
x3-galleta asiento tapizable de plástico

code	finishing	q.kit	q.pack	a	b	kg.x1	vol.x1
132203-003	● noir/negro	x1	20	400	410	0,60	mc. 0.003

- 07** vis hilo tb+ 5x12 cimentée brunie noire
tornillo hilo tb+ 5x12 cementado bruñido negro

code	finishing	q.kit seat	q.kit back
117803-154	● noir/negro	x8	x6

and · **12** **26** **10**

main component sizes

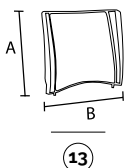

- 13** x3-dossier pour treillis noir en plastique
x3-respaldo para malla negro base de plástico

code	finishing	q.kit	q.pack	a	b	kg.x1	vol.x1
132103-014	● noir/negro	x1	10	400	460	0,60	mc. 0.008

- 14** x3-bandes a+b pour dossier treillis noir
x3-listones a+b para respaldo malla negro base

code	finishing	q.kit	q.pack	kg.x1	vol.x1
132103-013	● noir/negro	x1	100	0,21	mc. 0.0004

- 15** x3-treillis pour dossier
x3-malla para respaldo

code	finishing	q.kit	q.pack	a	b	kg.x1	vol.x1
132103-029	● noir/negro	x1	50	400	460	0,14	mc. 0.0057

- 16** vis médium tsp+ ø3,5x10 brunie noire (pour fixer dossier treillis)
tornillo para panel de aglomerado tsp+ d.3,5x10 bruñido negro (para fijar respaldo malla)

code	finishing	q.kit
117803-105	● noir/negro	x8

and · **26** **10** **11** **07**

X3

4-legs w/writing tablet

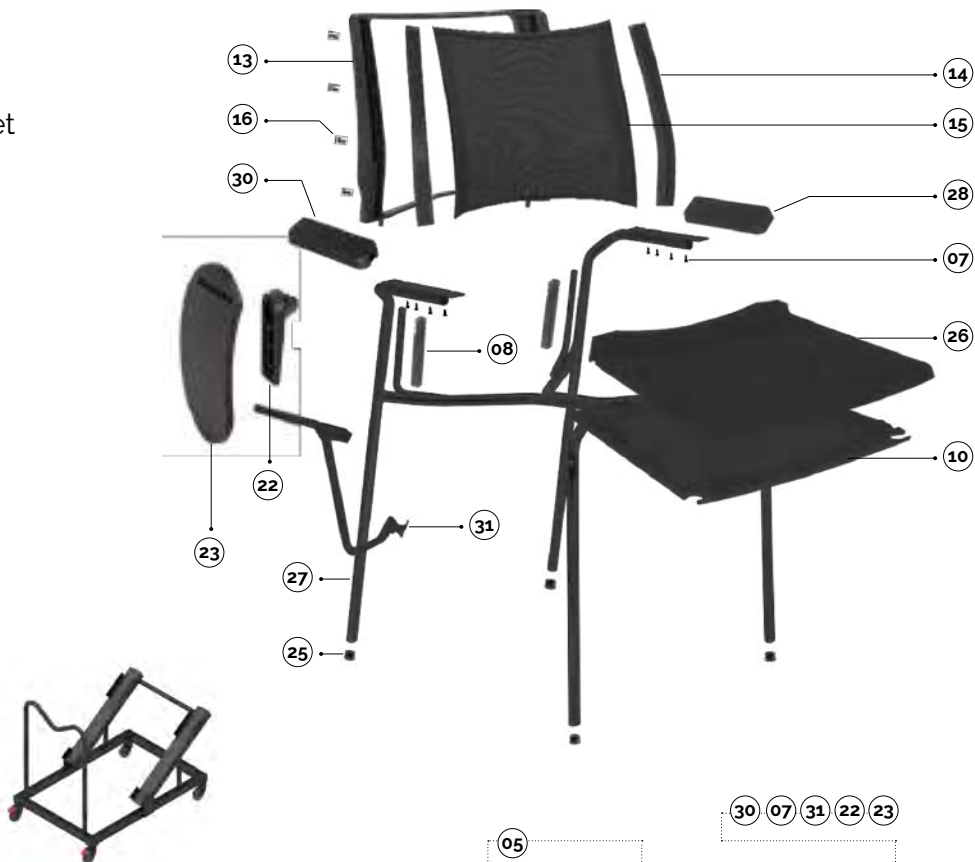

plastic colours

- gris/gris ral 7003
- noir/negro
- rouge/rojo 527
- blanc/blanco ral 1013

x3-chaîss 4 pieds d.18 avec accoudoirs
x3-carro para sillas con accesorios

code	finishing	q.kit	kg.x1
110803-346	● noir/negro	x1	10.50

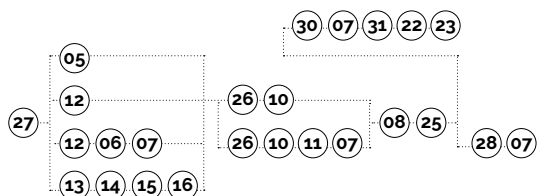

main component sizes

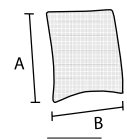
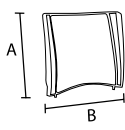
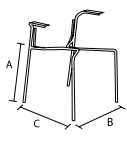

27 X3-châssis 4 pieds d.18 avec accoudoirs

x3-estructura 4 patas d. 18 con brazos

code	finishing	q.kit	q.pack	a	b	c	kg.x1	vol.x1
112703-051	● noir/negro	x1	60	455	465	550	2.80	mc. 0.035
112704-051	● gris/gris	x1	60	455	465	550	2.80	mc. 0.035
112710-054	● chromé/cromado	x1	60	455	465	550	2.80	mc. 0.035

13 X3-dossier pour treillis noir en plastique

x3-respaldo para malla negro base de plástico

code	finishing	q.kit	q.pack	a	b	kg.x1	vol.x1
132103-014	● noir/negro	x1	10	400	460	0.60	mc. 0.008

14 X3-bandes a+b pour dossier treillis noir

x3-listones a+b para respaldo malla negro base

code	finishing	q.kit	q.pack	kg.x1	vol.x1
132103-013	● noir/negro	x1	100	0.21	mc. 0.0004

15 X3-treillis pour dossier

x3-malla para respaldo

code	finishing	q.kit	q.pack	a	b	kg.x1	vol.x1
132103-029	● noir/negro	x1	50	400	460	0.14	mc. 0.0057

16 vis médium tsp+ ø3,5x10 brunie noire (pour fixer dossier treillis)

tornillo para panel de aglomerado tsp+ d.3,5x10 bruñido negro (para fijar respaldo malla)

code	finishing	q.kit
117803-105	● noir/negro	x8

28 X3-accoudoir plastique coloré pour châssis 4 pieds

x3-brazo de plástico de color para estructura 4 patas

code	finishing	q.kit	q.pack	a	b	kg.x1	vol.x1
131703-017	● noir/negro	x2	40	175	55	0.10	mc. 0.0004

07 vis hilo tb+ 5x12 cimentée brunie noire

tornillo hilo tb+ 5x12 cementado bruñido negro

code	finishing	q.kit seat	q.kit back
117803-154	● noir/negro	x8	x6

for the components below, see previous pages

25 08 26 10



for all colour codes, see page 259

X3

4-legs/tablet accessories

main component sizes

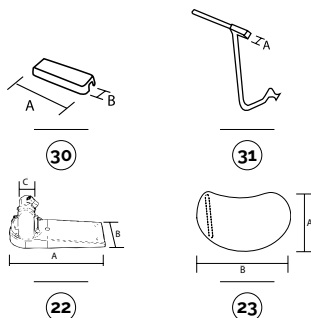

30 X3-accoudoir plastique coloré pour châssis 4 pieds avec tablette

code	finishing	q.kit	q.pack	a	b	kg.x1	vol.x1
131703-014	● noir/negro	x2	40	175	55	0.10	mc. 0.0004

31 X3-support tablette pour 4 pieds + vis

code	finishing	q.kit	q.pack	kg.x1	vol.x1
111703-043	● noir/negro droite/derecha-4 pieds/4 patas x1	10	15x15	0.60	mc. 0.002
111703-046	● noir/negro gauche/izquierda-4 pieds/4 patas x1	10	15x15	0.60	mc. 0.002
111710-037	● chromé/cromado droite/derecha-4 pieds/4 patas x1	10	15x15	0.60	mc. 0.002
111710-039	● chromé/cromado gauche/izquierda-4 pieds/4 patas x1	10	15x15	0.60	mc. 0.002

22 spt2-rotule pour tablette en plastique

code	finishing	q.kit	q.pack	a	b	c	kg.x1	vol.x1
134003-039	● noir/negro	x1	20	180	66	15x15	0.35	mc. 0.0006

23 bean-tablette en thermoplastique épaisseur 16 mm

code	finishing	q.kit	q.pack	a	b	kg.x1	vol.x1
134003-044	● noir/negro	x1	20	235	370	0.40	mc. 0.002



for writing tablet options, see page 404/405

4-legs w/armrests/backrest and seat options

main component sizes

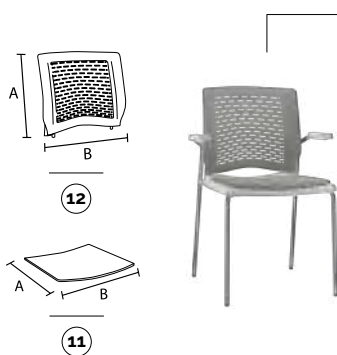

CERTIFIED BY
BIFMA

12 X3-dossier coloré en plastique à trous

code	finishing	q.kit	q.pack	a	b	kg.x1	vol.x1
132104-019	● gris/gris ral 7003	x1	10	400	460	0.90	mc. 0.008

11 X3-panneau assise à revêtir en plastique

code	finishing	q.kit	q.pack	a	b	kg.x1	vol.x1
132203-003	● noir/negro	x1	20	400	410	0.60	mc. 0.003

07 vis hilo tb+ 5x12 cimentée brunie noire

code	finishing	q.kit seat	q.kit back
117803-154	● noir/negro	x8	x6

and **26** **10**

main component sizes

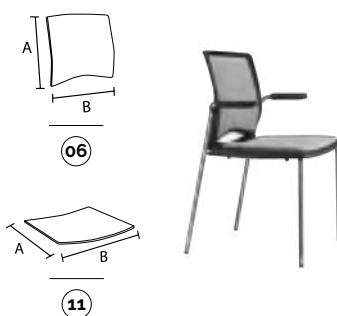

06 X3-panneau dossier à revêtir en plastique

code	finishing	q.kit	q.pack	a	b	kg.x1	vol.x1
132103-008	● noir/negro	x1	20	350	385	0.50	mc. 0.003

11 X3-panneau assise à revêtir en plastique

code	finishing	q.kit	q.pack	a	b	kg.x1	vol.x1
132203-003	● noir/negro	x1	20	400	410	0.60	mc. 0.003

07 vis hilo tb+ 5x12 cimentée brunie noire

code	finishing	q.kit seat	q.kit back
117803-154	● noir/negro	x8	x6

and **12** **26** **10**

X3

swivel



plastic colours

- gris/gris ral 7003
- noir/negro
- rouge/rojo 527
- blanc/blanco ral 1013

main component sizes

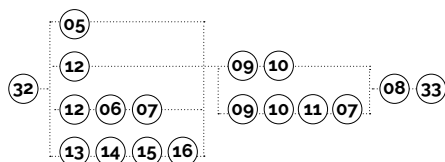
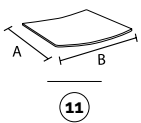
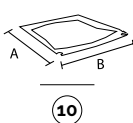
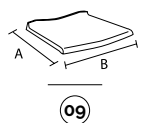
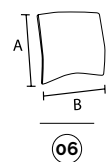
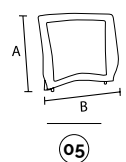
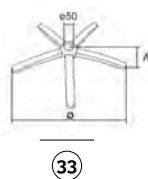

32 x3-support pivotant au gaz
x3-soporte versión giratoria con mecanismo de gas

code	finishing	q.kit	q.pack	kg.x1	vol.x1
110903-028	● noir/negro	x1	100	3,00	mc. 0,02
110904-014	● gris/gris	x1	100	3,00	mc. 0,02

33 b40-base en métal avec cache-soudure
b40-base de metal con embellecedor soldadura

code	finishing	q.kit	q.pack	a	ø	kg.x1	vol.x1
110210-027	● chromé/cromado	x1	5	60	640	2,85	mc. 0,014

05 x3-dossier coloré en plastique plein
x3-respaldo de color de plástico lleno

code	finishing	q.kit	q.pack	a	b	kg.x1	vol.x1
132103-090	● noir/negro	x1	10	400	460	0,90	mc. 0,008

06 x3-panneau dossier à revêtir en plastique
x3-panel respaldo tapizable de plástico

code	finishing	q.kit	q.pack	a	b	kg.x1	vol.x1
132103-008	● noir/negro	x1	20	350	385	0,50	mc. 0,003

07 vis hilo tb+ 5x12 cimentée brunie noire
tornillo hilo tb+ 5x12 cementado bruñido negro

code	finishing	q.kit seat	q.kit back
117803-154	● noir/negro	x8	x6

08 x3-adaptateur pour dossier en plastique
x3-adaptador para respaldo de plástico

code	finishing	q.kit	q.pack	kg.x1	vol.x1
132103-009	● noir/negro	x2	200	0,019	mc. 0,0001

09 x3-siège coloré en plastique pour châssis glissant
x3-asiento de color de plástico para estructura patin

code	finishing	q.kit	q.pack	a	b	kg.x1	vol.x1
132203-019	● noir/negro	x1	10	450	460	1,20	mc. 0,015

10 x3-renfort d'assise en plastique coloré
x3-parte inferior asiento de color base de plástico

code	finishing	q.kit	q.pack	a	b	kg.x1	vol.x1
132203-009	● noir/negro	x1	20	450	460	0,73	mc. 0,007

11 x3-panneau assise à revêtir en plastique
x3-galleta asiento tapizable de plástico

code	finishing	q.kit	q.pack	a	b	kg.x1	vol.x1
132203-003	● noir/negro	x1	20	400	410	0,60	mc. 0,003



X3

swivel/backrest and seat options

main component sizes

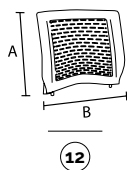

12 X3-dossier coloré en plastique à trous
X3-respaldo de color base de plástico perforado

code	finishing	q.kit	q.pack	a	b	kg.x1	vol.x1
132105-019	O blanc/blanco ral 1013	x1	10	400	460	0,90	mc. 0,008

and **09** **10**

main component sizes

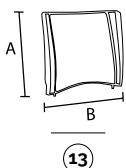

13 X3-dossier pour treillis noir en plastique
X3-respaldo para malla negro base de plástico

code	finishing	q.kit	q.pack	a	b	kg.x1	vol.x1
132103-014	● noir/negro	x1	10	400	460	0,60	mc. 0,008

14 X3-bandes a+b pour dossier treillis noir
X3-listones a+b para respaldo malla negros base

code	finishing	q.kit	q.pack	kg.x1	vol.x1
132103-013	● noir/negro	x1	100	0,21	mc. 0,0004

15 X3-treillis pour dossier
X3-malla para respaldo

code	finishing	q.kit	q.pack	a	b	kg.x1	vol.x1
132103-029	● noir/negro	x1	50	400	460	0,14	mc. 0,0057

16 vis médium tsp* ø3,5x10 brunie noire (pour fixer dossier treillis)
tornillo para panel de aglomerado tsp* d.3,5x10 bruñido negro (para fijar respaldo malla)

code	finishing	q.kit
117803-105	● noir/negro	x8

and **09** **10** **11** **07**

X3

swivel w/armrests



plastic colours

- gris/gris ral 7003
- noir/negro
- rouge/rojo 527
- blanc/blanco ral 1013

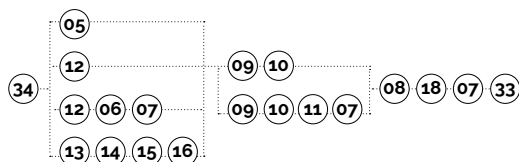

main component sizes

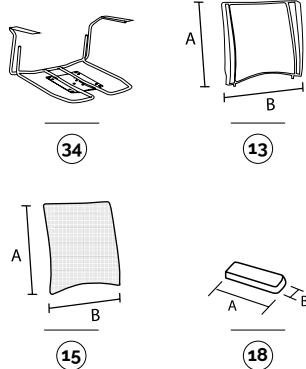

34 x3-châssis pivotant au gaz avec accoudoirs
x3-estructura versión giratoria con mecanismo de gas y brazos

code	finishing	q.kit	q.pack	kg.x1	vol.x1
110903-027	● noir/negro	x1	100	4,00	mc. 0,02
110904-015	● gris/gris	x1	100	4,00	mc. 0,02
110910-015	● chromé/cromado	x1	100	4,00	mc. 0,02

13 x3-dossier pour treillis noir en plastique
x3-respaldo para malla negro base de plástico

code	finishing	q.kit	q.pack	a	b	kg.x1	vol.x1
132103-014	● noir/negro	x1	10	400	460	0,60	mc. 0,008

14 x3-bandes a+b pour dossier treillis noir
x3-listones a+b para respaldo malla negros base

code	finishing	q.kit	q.pack	kg.x1	vol.x1
132103-013	● noir/negro	x1	100	0,21	mc. 0,0004

15 x3-treillis pour dossier
x3-malla para respaldo

code	finishing	q.kit	q.pack	a	b	kg.x1	vol.x1
132103-029	● noir/negro	x1	50	400	460	0,14	mc. 0,0057

16 vis médium tsp+ ø3,5x10 brunie noire (pour fixer dossier treillis)
tornillo para panel de aglomerado tsp+ d.3,5x10 bruñido negro (para fijar respaldo malla)

code	finishing	q.kit
117803-105	● noir/negro	x8

18 x3-accoudoir plastique coloré pour châssis fl
x3-brazo de plástico de color para estructura patin de varilla

code	finishing	q.kit	q.pack	a	b	kg.x1	vol.x1
131703-019	● noir/negro	x2	40	175	55	0,10	mc. 0,0004

07 vis hilo tb+ 5x12 cimentée brunie noire
tornillo hilo tb+ 5x12 cementado bruñido negro

code	finishing	q.kit seat	q.kit back
117803-154	● noir/negro	x8	x6

for the components below, see previous pages

33 08 09 10



for all colour codes, see page 259

X3

swivel w/armrests/backrest and seat options

main component sizes

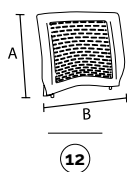

12 x3-dossier coloré en plastique à trous
x3-respaldo de color base de plástico perforado

code	finishing	q.kit	q.pack	a	b	kg.x1	vol.x1
132104-019	● gris/gris ral 7003	x1	10	400	460	0,90	mc. 0,008

and · **09** **10**

main component sizes

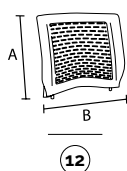

12 x3-dossier coloré en plastique à trous
x3-respaldo de color base de plástico perforado

code	finishing	q.kit	q.pack	a	b	kg.x1	vol.x1
132105-019	○ blanc/blanco ral 1013	x1	10	400	460	0,90	mc. 0,008

06 x3-panneau dossier à revêtir en plastique
x3-panel respaldo tapizable de plástico

code	finishing	q.kit	q.pack	a	b	kg.x1	vol.x1
132103-008	● noir/negro	x1	20	350	385	0,50	mc. 0,003

11 x3-panneau assise à revêtir en plastique
x3-galleta asiento tapizable de plástico

code	finishing	q.kit	q.pack	a	b	kg.x1	vol.x1
132203-003	● noir/negro	x1	20	400	410	0,60	mc. 0,003

07 vis hilo tb+ 5x12 cimentée brunie noire
tornillo hilo tb+ 5x12 cementado bruñido negro

code	finishing	q.kit seat	q.kit back
117803-154	● noir/negro	x8	x6

and · **09** **10**

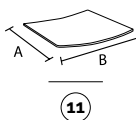
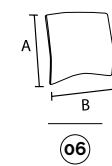

X3 bench



plastic colours

- gris/gris ral 7003
- noir/negro
- rouge/rojo 527
- blanc/blanco ral 1013

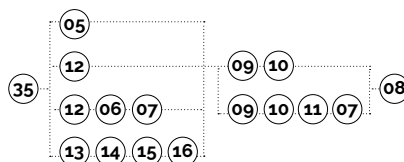

main component sizes

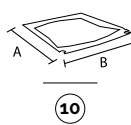
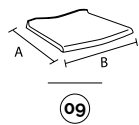
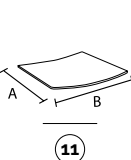
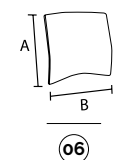
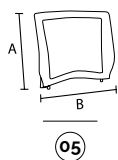
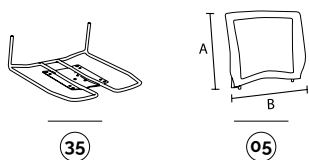

35 x3-châssis pour banquette x3-estructura para bancada

code	finishing	q.kit	q.pack	kg.x1	vol.x1
110703-041	● noir/negro	x1	100	2,70	mc. 0,02
110704-039	● gris/gris	x1	100	2,70	mc. 0,02

05 x3-dossier coloré en plastique plein x3-respaldo de color de plástico lleno

code	finishing	q.kit	q.pack	a	b	kg.x1	vol.x1
132103-090	● noir/negro	x1	10	400	460	0,90	mc. 0,008

06 x3-panneau dossier à revêtir en plastique x3-panel respaldo tapizable de plástico

code	finishing	q.kit	q.pack	a	b	kg.x1	vol.x1
132103-008	● noir/negro	x1	20	350	385	0,50	mc. 0,003

07 vis hilo tb+ 5x12 cimentée brunie noire tornillo hilo tb+ 5x12 cementado brunido negro

code	finishing	q.kit seat	q.kit back
117803-154	● noir/negro	x8	x6

08 x3-adaptateur pour dossier en plastique x3-adaptador para respaldo de plástico

code	finishing	q.kit	q.pack	kg.x1	vol.x1
132103-009	● noir/negro	x2	200	0,019	mc. 0,0001

09 x3-siège coloré en plastique pour châssis coulissant x3-asiento de color de plástico para estructura patin

code	finishing	q.kit	q.pack	a	b	kg.x1	vol.x1
132203-019	● noir/negro	x1	10	450	460	1,20	mc. 0,015

10 x3-renfort d'assise en plastique coloré x3-parte inferior asiento de color base de plástico

code	finishing	q.kit	q.pack	a	b	kg.x1	vol.x1
132203-009	● noir/negro	x1	20	450	460	0,73	mc. 0,007

11 x3-panneau assise à revêtir en plastique x3-galleta asiento tapizable de plástico

code	finishing	q.kit	q.pack	a	b	kg.x1	vol.x1
132203-003	● noir/negro	x1	20	400	410	0,60	mc. 0,003

for the bench components, see page 417



for all colour codes, see page 259

X3

bench w/armrests

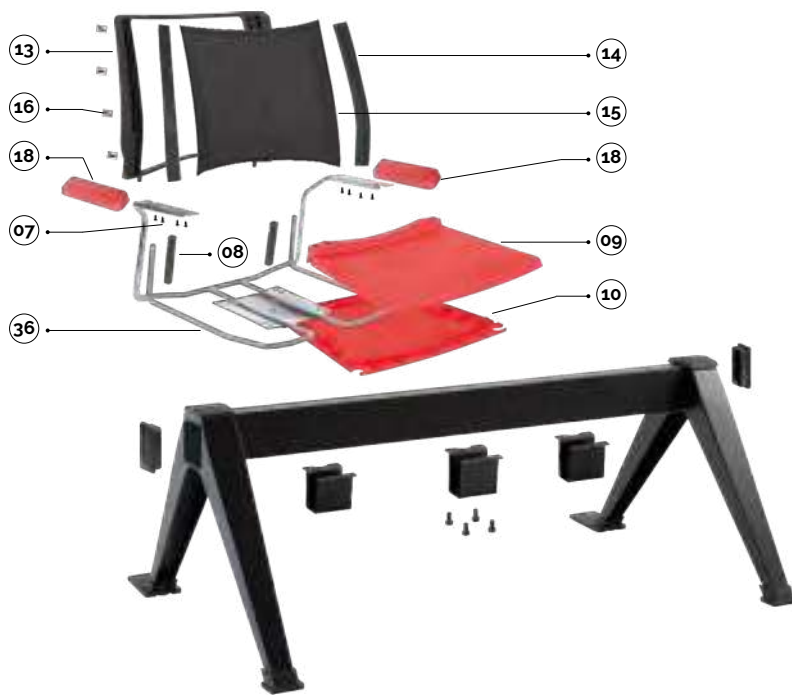

plastic colours

- gris/gris ral 7003
- noir/negro
- rouge/rojo 527
- blanc/blanco ral 1013

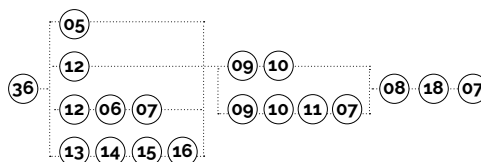

main component sizes

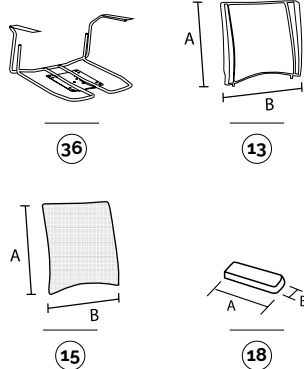

for the components below, see previous pages

08 09 10

for all colour codes, see page 259

36 x3-châssis pour banquette avec accoudoirs
x3-estructura para bancada con brazos

code	finishing	q.kit	q.pack	kg.x1	vol.x1
110703-044	● noir/negro	x1	100	3,60	mc. 0,02
110704-210	● gris/gris	x1	100	3,60	mc. 0,02
110710-044	● chromé/cromado	x1	100	3,60	mc. 0,02

13 x3-dossier pour treillis noir en plastique
x3-respaldo para malla negro base de plástico

code	finishing	q.kit	q.pack	a	b	kg.x1	vol.x1
132103-014	● noir/negro	x1	10	400	460	0,60	mc. 0,008

14 x3-bandes a+b pour dossier treillis noir
x3-listones a+b para respaldo malla negro base

code	finishing	q.kit	q.pack	kg.x1	vol.x1
132103-013	● noir/negro	x1	100	0,21	mc. 0,0004

15 x3-treillis pour dossier
x3-malla para respaldo

code	finishing	q.kit	q.pack	a	b	kg.x1	vol.x1
132103-029	● noir/negro	x1	50	400	460	0,14	mc. 0,0057

16 vis médium tsp* ø3,5x10 brunie noire (pour fixer dossier treillis)
tornillo para panel de aglomerado tsp* d.3,5x10 bruñido negro (para fijar respaldo malla)

code	finishing	q.kit
117803-105	● noir/negro	x8

18 x3-accoudoir plastique coloré pour châssis fl
x3-brazo de plástico de color para estructura patin de varilla

code	finishing	q.kit	q.pack	a	b	kg.x1	vol.x1
131702-019	● rouge/rojo 527	x2	40	175	55	0,10	mc. 0,0004

07 vis hilo tb* 5x12 cimentée brunie noire
tornillo hilo tb* 5x12 cementado bruñido negro

code	finishing	q.kit seat	q.kit back
117803-154	● noir/negro	x8	x6

OPTIONAL
bench connector

E-USB
bench plug

JIM
bench leg



90GM
bench leg

90GF
bench leg

91GM **NEW**
bench leg

100GM
bench leg

200GM
bench leg

PIONEER
bench arm

CUT
bench leg

SLIM
bench leg

CUT
bench arm

SLIM
bench arm



plastic

metal

aluminium

optionals

X3

bench w/armrests/backrest and seat options

main component sizes

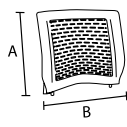

12



11



- 12 x3-dossier coloré en plastique à trous
x3-respaldo de color base de plástico perforado

code	finishing	q.kit	q.pack	a	b	kg.x1	vol.x1
132104-019	● gris/gris ral 7003	x1	10	400	460	0,90	mc. 0,008

- 11 x3-panneau assise à revêtir en plastique
x3-galleta asiento tapizable de plástico

code	finishing	q.kit	q.pack	a	b	kg.x1	vol.x1
132203-003	● noir/negro	x1	20	400	410	0,60	mc. 0,003

- 07 vis hilo tb+ 5x12 cimentée brunie noire
tornillo hilo tb+ 5x12 cementado bruñido negro

code	finishing	q.kit seat	q.kit back
117803-154	● noir/negro	x8	x6

and - 09 10

main component sizes

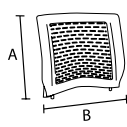

12

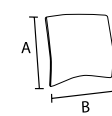

06

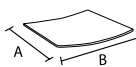

11



- 12 x3-dossier coloré en plastique à trous
x3-respaldo de color base de plástico perforado

code	finishing	q.kit	q.pack	a	b	kg.x1	vol.x1
132105-019	○ blanc/blanco ral 1013	x1	10	400	460	0,90	mc. 0,008

- 06 x3-panneau dossier à revêtir en plastique
x3-panel respaldo tapizable de plástico

code	finishing	q.kit	q.pack	a	b	kg.x1	vol.x1
132103-008	● noir/negro	x1	20	350	385	0,50	mc. 0,003

- 11 x3-panneau assise à revêtir en plastique
x3-galleta asiento tapizable de plástico

code	finishing	q.kit	q.pack	a	b	kg.x1	vol.x1
132203-003	● noir/negro	x1	20	400	410	0,60	mc. 0,003

- 07 vis hilo tb+ 5x12 cimentée brunie noire
tornillo hilo tb+ 5x12 cementado bruñido negro

code	finishing	q.kit seat	q.kit back
117803-154	● noir/negro	x8	x6

and - 09 10

X3

optional colour codes



plastic colour codes



12 dossier en plastique à trous
respaldo de plástico perforado

- 132104-019 gris/gris ral 7003
- 132103-019 noir/negro
- 132105-019 blanc/blanco ral 1013



05 dossier en plastique plein
respaldo de plástico lleno

- 132103-090 noir/negro

● rouge/rojo 527
Moq. 300pz/order



09 siège en plastique pour châssis coulissant
asiento de plástico para carcasa patin

- 132204-019 gris/gris ral 7003
- 132203-019 noir/negro
- 132205-019 blanc/blanco ral 1013



26 siège en plastique pour châssis 4 pieds
asiento de plástico para estructura 4 patas

- 132204-018 gris/gris ral 7003
- 132203-018 noir/negro
- 132205-018 blanc/blanco ral 1013



10 renfort d'assise en plastique
parte inferior asiento de plástico

- 132204-009 gris/gris ral 7003
- 132203-009 noir/negro
- 132205-009 blanc/blanco ral 1013



18 accoudoir plastique pour châssis coulissant
brazo de plástico para carcasa patin

- 131704-019 gris/gris ral 7003
- 131703-019 noir/negro
- 131705-019 blanc/blanco ral 1013



20 accoudoir plastique pour châssis coulissant avec tablette
brazo de plástico para carcasa patin con pala

- 131704-018 gris/gris ral 7003
- 131703-018 noir/negro
- 131705-018 blanc/blanco ral 1013



28 accoudoir plastique pour châssis 4 pieds
brazo de plástico para estructura 4 patas

- 131704-017 gris/gris ral 7003
- 131703-017 noir/negro
- 131705-017 blanc/blanco ral 1013



30 accoudoir plastique pour châssis 4 pieds avec tablette
brazo de plástico para estructura 4 patas con pala

- 131704-014 gris/gris ral 7003
- 131703-014 noir/negro
- 131705-014 blanc/blanco ral 1013



aria



discover more about
Aria Collection

Aria est un banc polyvalent.
Résistant, fonctionnel et adaptable à tout type d'environnement grâce à une coque entièrement en métal peint en noir ou gris. Possibilité d'optimiser le confort et le style grâce aux nouveaux panneaux rembourrés en option pour dossier et assise.

Aria est parfait pour aménager des salles d'attente et des espaces publics ou privés.

*Aria, la bancada versátil.
Resistente, funcional y adaptable a todas las situaciones con su carcasa totalmente metálica, pintada en de color negro o gris. Nuevas galletas acolchadas para respaldo y asiento, disponibles como opcionales, para regalar lo máximo en confort y estilo.*

Aria es perfecta para amueblar salas de espera y espacios públicos y privados.

Plus

- Facile à nettoyer.
- Confort optimal grâce aux nouveaux panneaux rembourrés en option.
- Facile à tapisser et à assembler.
- Certification EN 16139:2013+AC2013 Niveau 2.
- Certification EN 15373:2017 Niveau 3.
- *Limpieza fácil.*
- *Máximo confort con las nuevas galletas acolchadas disponibles como opcionales.*
- *Fácil de tapizar y de ensamblar.*
- *Certificación EN 16139:2013+AC2013 Nivel 2.*
- *Certificación EN 15373:2017 Nivel 3.*



designed by:
R&D Alba



**certified
product**

aria

bench

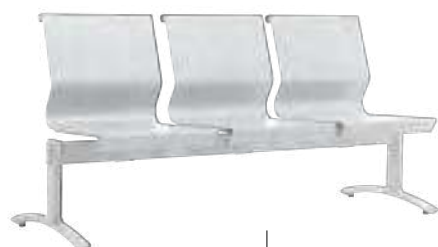
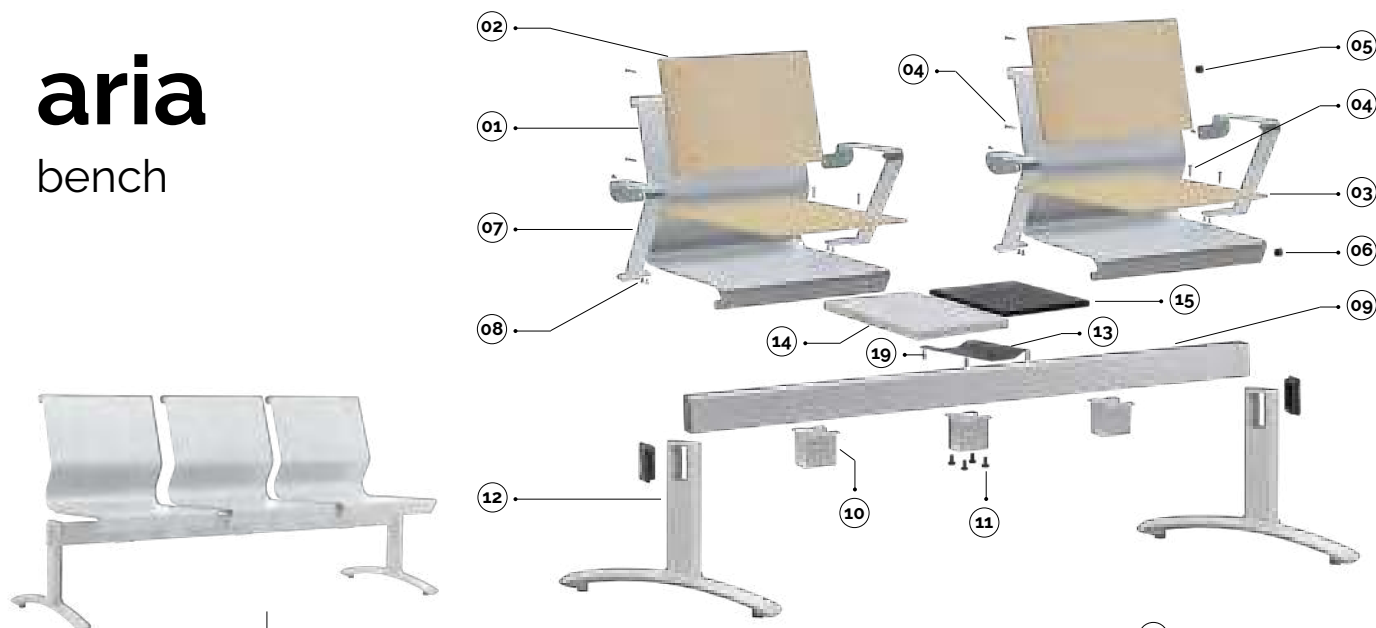

CERTIFIED BY
CATAS

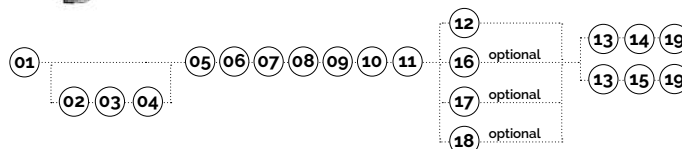

01 aria-coque entière en tôle
aria-carcasa completa de chapa

code	finishing	q.kit	q.pack	a	b	kg.x1	vol.x1
110703-065	● noir/negro	x1	25	475	490	9,86	mc. 0.02
110703-066	● noir/negro holes for arms	x1	25	475	490	9,86	mc. 0.02
110704-025	● gris/gris	x1	25	475	490	9,86	mc. 0.02
110704-027	● gris/gris holes for arms	x1	25	475	490	9,86	mc. 0.02

02 aria-shl-panneau dossier en bois
aria-shl-respaldo de madera

code	finishing	q.kit	q.pack	a	b	kg.x1	vol.x1
122107-007	● hêtre/haya	x1	20	430	245	0,45	mc. 0.00225

03 aria-sdl-panneau assise en bois
aria-sdl-panel asiento de madera

code	finishing	q.kit	q.pack	a	b	kg.x1	vol.x1
122207-007	● hêtre/haya	x1	20	430	420	0,735	mc. 0.00225

04 vis tbei m4x8 zinguée blanc
tornillos tbei m4x8 galvanizado blanco

code	finishing	q.kit
117703-126	○ zinguée blanc/galvanizado blanco	x4

05 embout couvre-tête ovale 40x20 tête chromée
tapón embellecedor oval 40x20 cabeza cromada

code	finishing	q.kit
134110-001	● chromé/cromado	x2

06 embouts couvre-tête d.20 tête chromé
tapones embellecedores d.20 cromado

code	finishing	q.kit
134110-200	● chromé/cromado	x2

07 aria-accoudoir en métal pour coque
aria-brazo de metal para carcasa

code	finishing	q.kit	q.pack	a	b	kg.x1	vol.x1
111703-001	● noir/negro droit/derecha	x1	5	300	270	1,68	mc. 0.02
111703-002	● noir/negro gauche/izquierda	x1	5	300	270	1,68	mc. 0.02
111704-001	● gris/gris droit/derecha	x1	5	300	270	1,68	mc. 0.02
111704-002	● gris/gris gauche/izquierda	x1	5	300	270	1,68	mc. 0.02

08 vis tête bombée hexagonale encaissée m6x14 zinguée
tornillo cabeza convexa hexagonal embutida m6x14 galvanizado

code	finishing	q.kit
117711-185	○ zinguée/galvanizado	x3

09 got(03) poutre pour banquette 80x40
got(03) viga para bancada 80x40

code	finishing	q.kit	q.pack	a	b	c	kg.x1	vol.x1
110703-190	● noir/negro 2 places/2 asientos	x1	1	1160	80	40	3,20	mc. 0.0045
110704-090	● gris/gris 2 places/2 asientos	x1	1	1160	80	40	3,20	mc. 0.0045
110703-191	● noir/negro 3 places/3 asientos	x1	1	1710	80	40	4,71	mc. 0.005
110704-091	● gris/gris 3 places/3 asientos	x1	1	1710	80	40	4,71	mc. 0.005
110703-192	● noir/negro 4 places/4 asientos	x1	1	2260	80	40	6,22	mc. 0.0085
110704-092	● gris/gris 4 places/4 asientos	x1	1	2260	80	40	6,22	mc. 0.0085
110703-193	● noir/negro 5 places/5 asientos	x1	1	2800	80	40	7,72	mc. 0.01
110704-193	● gris/gris 5 places/5 asientos	x1	1	2800	80	40	7,72	mc. 0.01

10 gocv-cavalier pour dessous poutre
gocv-caballote bajo viga

code	finishing	q.kit	q.pack	a	b	kg.x1	vol.x1
110703-007	● noir/negro	x1	50	55	65	0,60	mc. 0.0005
110704-016	● gris/gris	x1	50	55	65	0,60	mc. 0.0005

11 pack vis m8x12 tête cylindrique hexagonale encaissée brunie noire
paquete tornillo m8x12 cabeza cilíndrica hexagonal embutida bruñido negro

code	finishing	q.kit	q.pack
117003-070	● noir/negro	x4	200

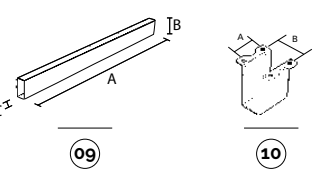
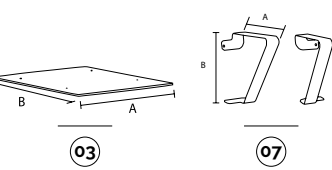
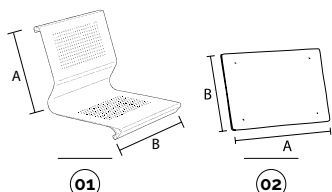

main component sizes

for the bench components, see page 417

aria

bench leg options

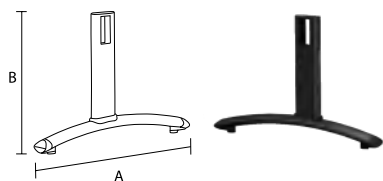

12 90gm-pied mobile pour banquette avec accessoires 90gm-pata móvil para bancada con accesorios

code	finishing	q.kit	q.pack	a	b	kg.x1	vol.x1
110703-581	● noir/negro	x2	2	620	376	2,7	mc. 0,03
110704-581	● gris/gris I G2621	x2	2	620	376	2,7	mc. 0,03
110704-582	● gris/gris drylac	x2	2	620	376	2,7	mc. 0,03
110705-581	○ blanc/blanco ral 9010	x2	2	620	376	2,7	mc. 0,03
110710-581	● chromé/cromado	x2	2	620	376	2,7	mc. 0,03

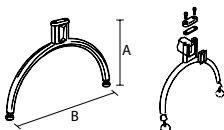

16 100gm-pied mobile pour banquette avec accessoires 100gm-pata móvil para bancada con accesorios

code	finishing	q.kit	q.pack	a	b	kg.x1	vol.x1
110703-008	● noir/negro	x2	2	380	600	2,10	mc. 0,012
110704-004	● gris/gris	x2	2	380	600	2,10	mc. 0,012
110710-005	● chromé/cromado	x2	2	380	600	2,10	mc. 0,012

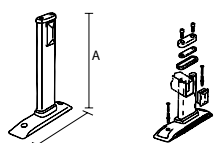

17 90gf-pied fixe pour banquette avec accessoires 90gf-pata fija para bancada con accesorios

code	finishing	q.kit	q.pack	a	b	kg.x1	vol.x1
110703-030	● noir/negro	x2	2	380	310	1,90	mc. 0,006
110704-011	● gris/gris	x2	2	380	310	1,90	mc. 0,006

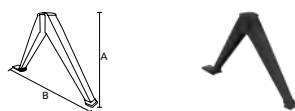

18 200gm-pied mobile pour banquette avec accessoires 200gm-pata móvil para bancada con accesorios

code	finishing	q.kit	q.pack	a	b	kg.x1	vol.x1
110703-110	● noir/negro	x2	2	380	600	2,60	mc. 0,005
110704-112	● gris/gris	x2	2	380	600	2,60	mc. 0,005
110710-110	● chromé/cromado	x2	2	380	600	2,60	mc. 0,005



optionals

plastic

metal

aluminium

bench table options

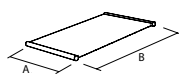

13 90ap-raccordement porte plateau 90ap-enganche soporte mesa

code	finishing	q.kit	q.pack	a	b	c	d	kg.x1	vol.x1
110703-014	● noir/negro	x1	25	170	200	65	55	1,00	mc. 0,002
110704-019	● gris/gris	x1	25	170	200	65	55	1,00	mc. 0,002

14 aria-tablette pour banquette en tôle aria-mesa para bancada de chapa

code	finishing	q.kit	q.pack	a	b	kg.x1	vol.x1
110703-069	● noir/negro	x1	25	370	500	5,50	mc. 0,01
110704-030	● gris/gris	x1	25	370	500	5,50	mc. 0,01

15 90tn-plateau de table pour banquette 90tn-mesa para bancada

code	finishing	q.kit	q.pack	a	b	kg.x1	vol.x1
120303-001	● noir/negro	x1	10	400	400	2,20	mc. 0,002

19 vis tc + m6x12 brunie noire tornillo tc + m6x12 bruñido negro

code	finishing	q.kit
117703-177	● noir/negro	x4

aria

bench cut & slim version

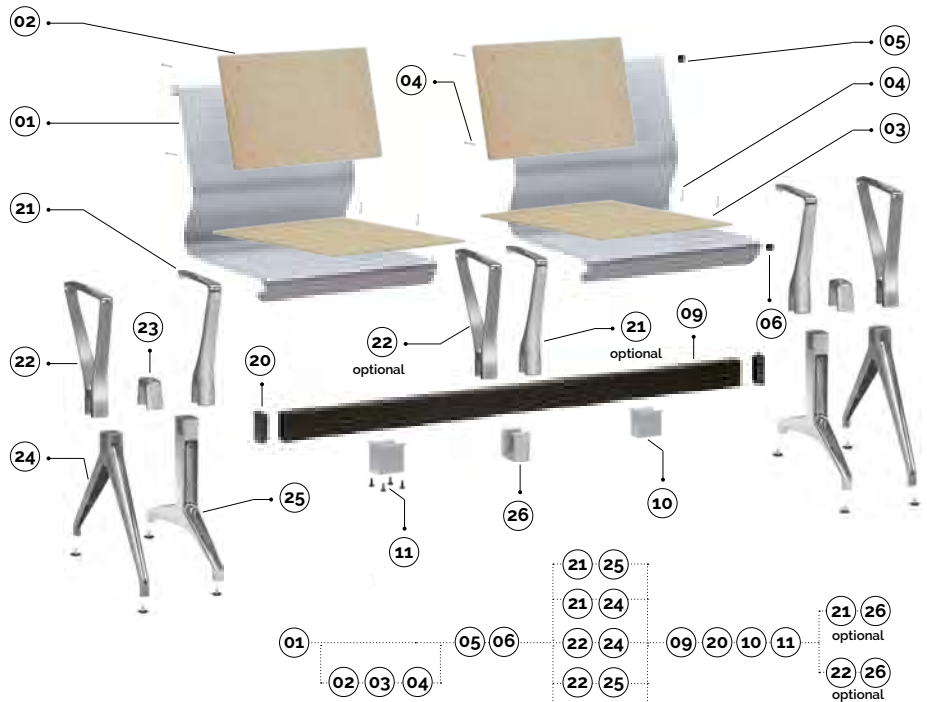

21 embout couvre-tête rectangulaire 80x40 noir
tapón embellecedor rectangular 80 x 40 negro

code	finishing	q.kit	q.pack	a	b	kg.x1	vol.x1
111704-223	● aluminium/aluminio	x1	10	300	305	1,48	mc. 0,0011

22 cut-accoudoir en aluminium pour banquette + 2 vis
cut-brazo de aluminio para bancada + n.2 tornillos

code	finishing	q.kit	q.pack	a	b	kg.x1	vol.x1
111704-225	● aluminium/aluminio	x1	10	325	305	1,35	mc. 0,0011

23 slim-accoudoir en aluminium pour banquette + 2 vis
slim-brazo de aluminio para bancada + n.2 tornillos

code	finishing	q.kit	q.pack	a	b	kg.x1	vol.x1
111704-222	● aluminium/aluminio	x1	10	60	95	0,30	mc. 0,0012

24 cut/slim-cavalier en aluminium pour pied banquette + 2 vis
cut/slim caballete de aluminio para pata bancada + n.2 tornillos

code	finishing	q.kit	q.pack	a	b	kg.x1	vol.x1
111704-226	● aluminium/aluminio	x2	5	610	350	1,15	mc. 0,014

25 slim-pied en aluminium pour banquette + 2 pieds
slim-pata de aluminio para bancada + n.2 pies

code	finishing	q.kit	q.pack	a	b	kg.x1	vol.x1
111704-224	● aluminium/aluminio	x2	5	610	350	2,55	mc. 0,014

20 capuchon rectangulaire 80x40 noir
gorro de cabeza rectangular 80x40 negro

code	finishing	q.kit
134103-001	● noir/negro	x2

09 got(03) poutre pour banquette 80x40
got(03) viga para bancada 80x40

code	finishing	places	q.kit	q.pack	a	b	c	kg.x1	vol.x1
110703-190	● noir/negro	2 places/2 asientos	x1	1	1160	80	40	3,20	mc. 0,0045
110704-090	● gris/gris	2 places/2 asientos	x1	1	1160	80	40	3,20	mc. 0,0045
110703-191	● noir/negro	3 places/3 asientos	x1	1	1710	80	40	4,71	mc. 0,005
110704-091	● gris/gris	3 places/3 asientos	x1	1	1710	80	40	4,71	mc. 0,005
110703-192	● noir/negro	4 places/4 asientos	x1	1	2260	80	40	6,22	mc. 0,0085
110704-092	● gris/gris	4 places/4 asientos	x1	1	2260	80	40	6,22	mc. 0,0085
110703-193	● noir/negro	5 places/5 asientos	x1	1	2800	80	40	7,72	mc. 0,01
110704-193	● gris/gris	5 places/5 asientos	x1	1	2800	80	40	7,72	mc. 0,01

10 gocv-cavalier pour dessous poutre
gocv-caballete bajo viga

code	finishing	q.kit	q.pack	a	b	kg.x1	vol.x1
110703-007	● noir/negro	x1	50	55	65	0,60	mc. 0,0005
110704-016	● gris/gris	x1	50	55	65	0,60	mc. 0,0005

11 pack vis m8x12 tête cylindrique hexagonale encaissée brunie noire
paquete tornillo m8x12 cabeza cilíndrica hexagonal embutida bruñido negro

code	finishing	q.kit	q.pack
117003-070	● noir/negro	x4	200

26 cut-pied en aluminium pour banquette + 2 pieds
cut-pata de aluminio para bancada + n.2 pies

code	finishing	q.kit	q.pack	a	b	kg.x1	vol.x1
111704-221	● aluminium/aluminio	x1	10	58	95	0,27	mc. 0,0012

main component sizes

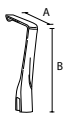

21

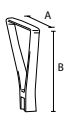

22

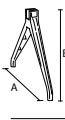

24

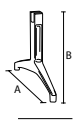

25

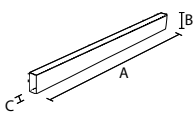

09

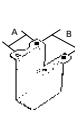

10

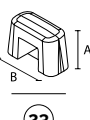

23

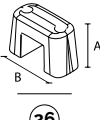

26

for the components below, see previous pages

01 02 03 04 05 06

for the bench components, see page 417

OPTIONAL
bench connector



E-USB
bench plug



JIM
bench leg



plastic

90GM
bench leg



90GF
bench leg



91GM **NEW**
bench leg



100GM
bench leg



200GM
bench leg



PIONEER
bench arm



CUT
bench leg



SLIM
bench leg



CUT
bench arm



SLIM
bench arm



metal

aluminium





nexus



discover more about
Nexus Collection

Un banc entièrement métallique.
Une pièce unique au design essentiel,
assurant une assise confortable et très
stable.
Les châssis empilables à 4 pieds et à
traîneau complètent la famille.

Nexus est parfait pour tous les lieux
publics et les salles d'attente.

*La bancada totalmente metálica.
Una pieza única, con un diseño esencial,
que garantiza un asiento cómodo y muy
estable.
Las 4 estructuras apilables de 4 patas y
de patin completan la familia.*

*Nexus es ideal para todos los ambientes
de la comunidad y las zonas de espera.*

Plus

- Une structure innovante,
développée en une seule pièce et
entièrement métallique.
- Un design caractéristique
grâce surtout à sa coque ajourée,
entièrement métallique et proposée
avec 4 finitions.
- Fonctionnelle et facile à nettoyer.
- Certification EN 16139:2013+AC2013
Niveau 2.
- *Estructura innovadora, desarrollada
en una única pieza y realizada
totalmente en metal.*
- *Diseño distintivo, sobre todo por
su carcasa perforada, totalmente
realizada en metal y disponible en 4
acabados.*
- *Funcional y fácil de limpiar.*
- *Certificación EN 16139:2013+AC2013
Nivel 2.*



designed by:
**Esdra &
Alessandro Crosera & Partners**



**trolley
available**



**certified
product**

nexus

bench

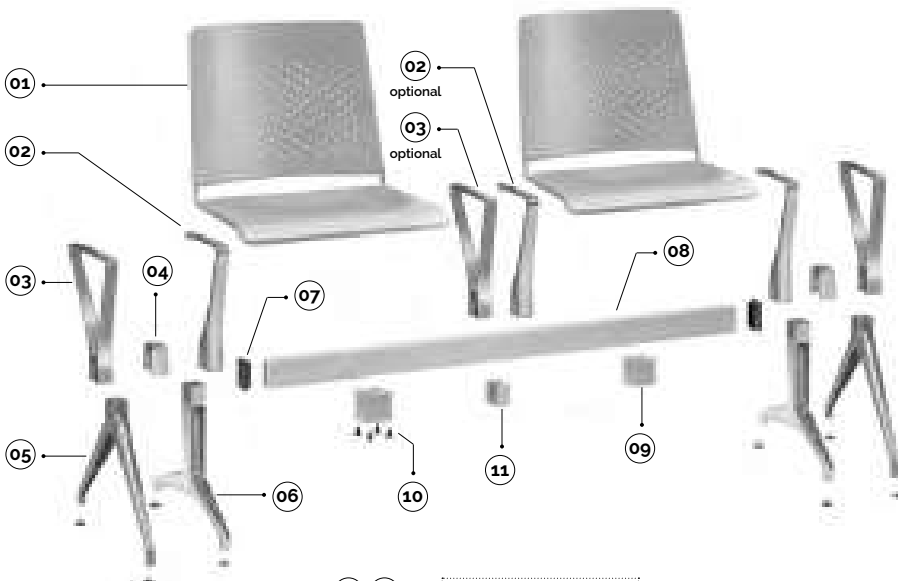
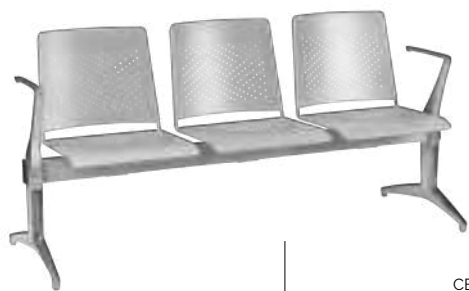

CERTIFIED BY
CATAS

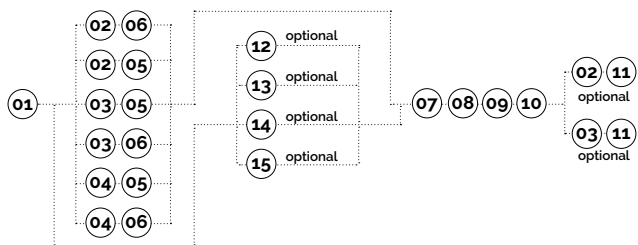

Corten • *Une caractéristique spécifique du Corten est la variabilité dans la tonalité de la finition.
* Una característica particular del Corten es las variabilidad en la tonalidad del acabado.

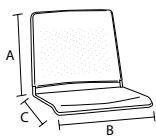

01

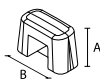

04

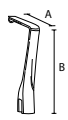

02

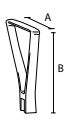

03

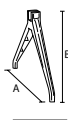

05

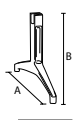

06

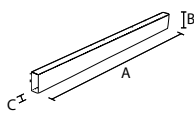

08

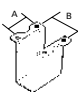

09



11

01 nexus-coque en tôle
nexus-carcasa de chapa

code	finishing	q.kit	q.pack	a	b	c	kg.x1	vol.x1
110703-220	● noir/negro	x1	60	405	454	545	7,60	mc. 0.02
110704-220	● gris/gris	x1	60	405	454	545	7,60	mc. 0.02
110705-220	○ blanc/blanco ral9010	x1	60	405	454	545	7,60	mc. 0.02
110707-220	● corten*	x1	60	405	454	545	7,60	mc. 0.02

02 cut-accoudoir en aluminium pour banquette + 2 vis
cut-brazo de aluminio para bancada + n.2 tornillos

code	finishing	q.kit	q.pack	a	b	kg.x1	vol.x1
111704-223	● aluminium/aluminio	x1	10	300	305	1,40	mc. 0.0011

03 slim-accoudoir en aluminium pour banquette + 2 vis
slim-brazo de aluminio para bancada + n.2 tornillos

code	finishing	q.kit	q.pack	a	b	kg.x1	vol.x1
111704-225	● aluminium/aluminio	x1	10	325	305	1,40	mc. 0.0011

04 cut/slim-cavalier en aluminium pour pied banquette + 2 vis
cut/slim caballete de aluminio para pata bancada + n.2 tornillos

code	finishing	q.kit	q.pack	a	b	kg.x1	vol.x1
111704-222	● aluminium/aluminio	x1	10	60	95	0,40	mc. 0.0012

05 slim-pied en aluminium pour banquette + 2 pieds
slim-pata de aluminio para bancada + n.2 pies

code	finishing	q.kit	q.pack	a	b	kg.x1	vol.x1
111704-226	● aluminium/aluminio	x2	5	610	350	1,20	mc. 0.014

06 cut-pied en aluminium pour banquette + 2 pieds
cut-pata de aluminio para bancada + n.2 pies

code	finishing	q.kit	q.pack	a	b	kg.x1	vol.x1
111704-224	● aluminium/aluminio	x2	5	610	350	2,55	mc. 0.014

07 embout couvre-tête rectangulaire 80x40 noir
tapon embellecedor rectangular 80 x 40 negro

code	finishing	q.kit
134103-001	● noir/negro	x2

08 got(03) poutre pour banquette 80x40
got(03) viga para bancada 80x40

code	finishing	q.kit	q.pack	a	b	c	kg.x1	vol.x1	
110703-190	● noir/negro	2 places/2 asientos	x1	1	1160	80	40	3,20	mc. 0.0045
110704-090	● gris/gris	2 places/2 asientos	x1	1	1160	80	40	3,20	mc. 0.0045
110703-191	● noir/negro	3 places/3 asientos	x1	1	1710	80	40	4,71	mc. 0.005
110704-091	● gris/gris	3 places/3 asientos	x1	1	1710	80	40	4,71	mc. 0.005
110703-192	● noir/negro	4 places/4 asientos	x1	1	2260	80	40	6,22	mc. 0.0085
110704-092	● gris/gris	4 places/4 asientos	x1	1	2260	80	40	6,22	mc. 0.0085
110703-193	● noir/negro	5 places/5 asientos	x1	1	2800	80	40	7,72	mc. 0.01
110704-193	● gris/gris	5 places/5 asientos	x1	1	2800	80	40	7,72	mc. 0.01

09 gocv-cavalier pour dessous poutre
gocv-caballete bajo viga

code	finishing	q.kit	q.pack	a	b	kg.x1	vol.x1
110703-007	● noir/negro	x1	50	55	65	0,60	mc. 0.0005
110704-016	● gris/gris	x1	50	55	65	0,60	mc. 0.0005

10 pack vis m8x12 tête cylindrique hexagonale encaissée brunie noire
paquete de tornillos m8x12 cabeza cilindrica hexagonal embutida bruniado negro

code	finishing	q.kit	q.pack
117003-070	● noir/negro	x4	200

11 cut/slim-cavalier en aluminium pour accoudoir banquette
cut/slim caballete de aluminio para brazo bancada

code	finishing	q.kit	q.pack	a	b	kg.x1	vol.x1
111704-221	● aluminium/aluminio	x1	10	58	95	0,32	mc. 0.0012

main component sizes

for the bench components, see page 417

nexus

bench leg options

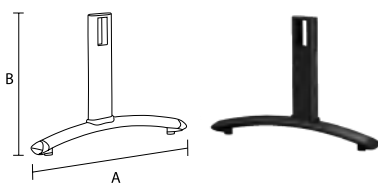

12 g1GM - pied mobile pour banquette avec accessoires
g1GM - pata móvil para banco con accesorios

code	finishing	q.kit	q.pack	a	b	kg.x1	vol.x1
110703-581	● noir/negro	x2	2	620	376	2,7	mc. 0.03
110704-581	● gris/gris IG2621	x2	2	620	376	2,7	mc. 0.03
110704-582	● gris/gris drylac	x2	2	620	376	2,7	mc. 0.03
110705-581	○ blanc/blanco ral 9010	x2	2	620	376	2,7	mc. 0.03
110710-581	● chromé/cromado	x2	2	620	376	2,7	mc. 0.03

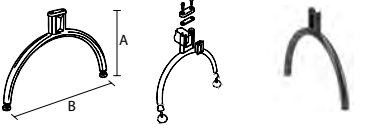

13 100gm-pied mobile pour banquette avec accessoires
100gm-pata móvil para banco con accesorios

code	finishing	q.kit	q.pack	a	b	kg.x1	vol.x1
110703-008	● noir/negro	x2	2	380	600	2,10	mc. 0.012
110704-004	● gris/gris	x2	2	380	600	2,10	mc. 0.012
110710-005	● chromé/cromado	x2	2	380	600	2,10	mc. 0.012

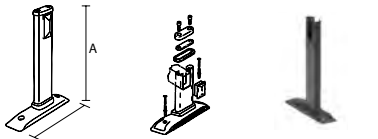

14 90gf-pied fixe pour banquette avec accessoires
90gf-pata fija para banco con accesorios

code	finishing	q.kit	q.pack	a	b	kg.x1	vol.x1
110703-030	● noir/negro	x2	2	380	310	1,90	mc. 0.006
110704-011	● gris/gris	x2	2	380	310	1,90	mc. 0.006

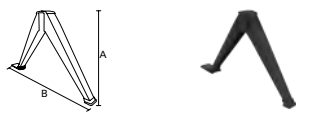

15 200gm-pied mobile pour banquette avec accessoires
200gm-pata móvil para banco con accesorios

code	finishing	q.kit	q.pack	a	b	kg.x1	vol.x1
110703-110	● noir/negro	x2	2	380	600	2,60	mc. 0.005
110704-112	● gris/gris	x2	2	380	600	2,60	mc. 0.005
110710-110	● chromé/cromado	x2	2	380	600	2,60	mc. 0.005

optionals

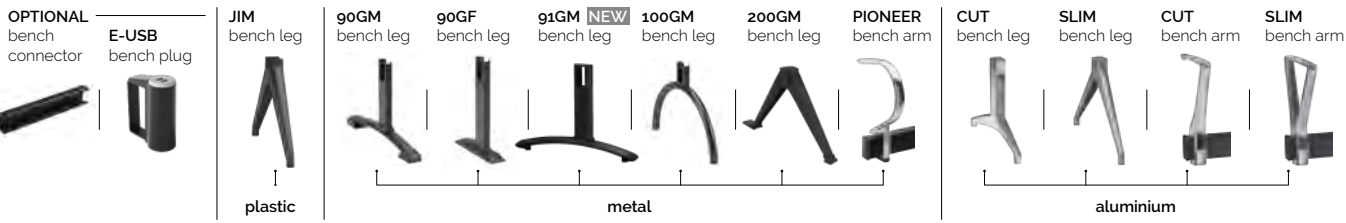

bench sizes

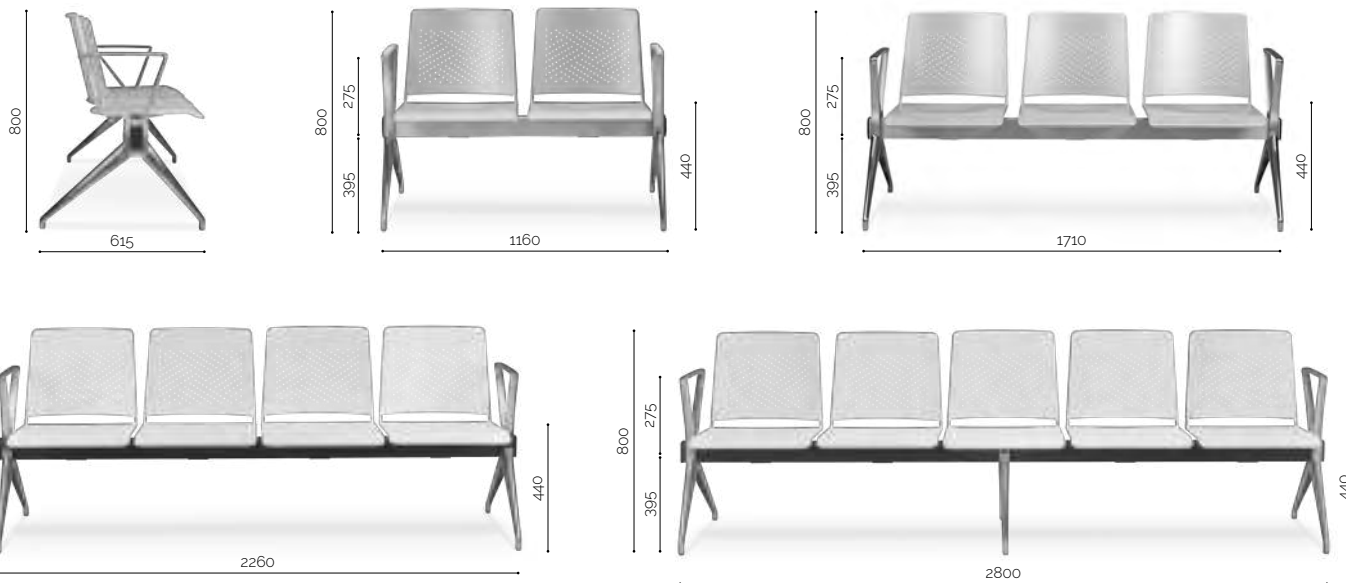

nexus

bench

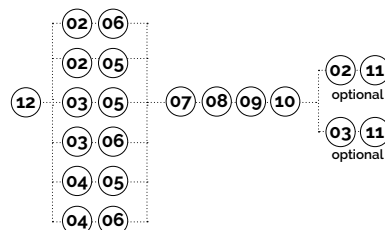
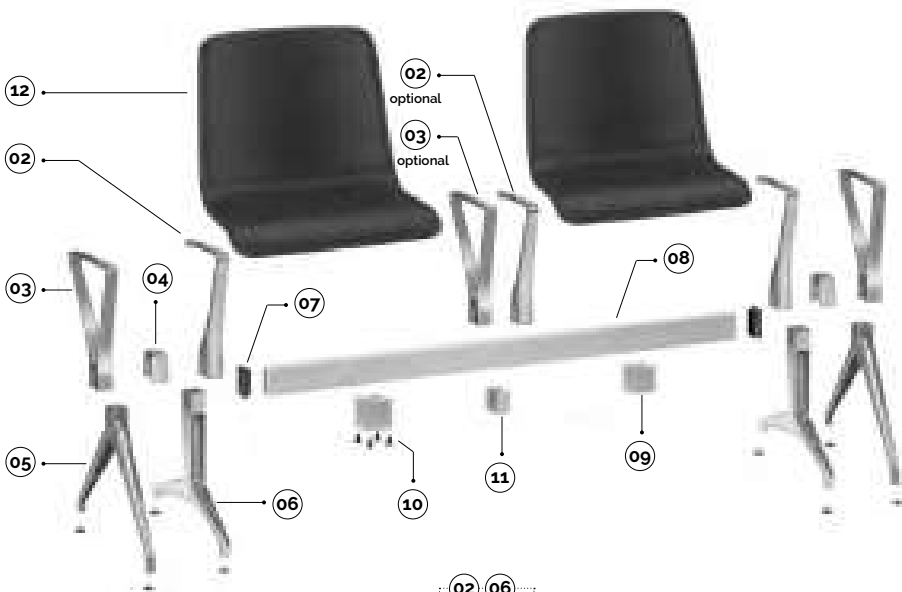

Proposée dans différentes couleurs mono/bi-couleur en lots de 100 pièces

12

Disponible en différentes couleurs mono/bi-couleur para lotes de 100 unidades

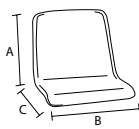

12

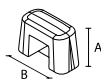

04

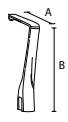

02

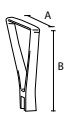

03

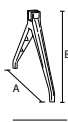

05

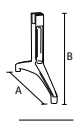

06

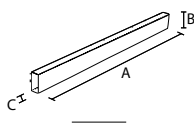

08



09

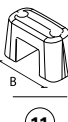

11

12 nexus-coque en polyurethane souple freeform advanced
nexus-carcasa de poliuretano blando freeform advanced

code	finishing	q.kit	q.pack	a	b	c	kg.x1	vol.x1
133903-061	● noir/negro	x1		410	485	430	7,60	mc. 0.09

02 cut-accoudoir en aluminium pour banquette • 2 vis
cut-brazo de aluminio para bancada + n.2 tornillos

code	finishing	q.kit	q.pack	a	b	kg.x1	vol.x1
111704-223	● aluminium/aluminio	x1	10	300	305	1,40	mc. 0.0011

03 slim-accoudoir en aluminium pour banquette • 2 vis
slim-brazo de aluminio para bancada + n.2 tornillos

code	finishing	q.kit	q.pack	a	b	kg.x1	vol.x1
111704-225	● aluminium/aluminio	x1	10	325	305	1,40	mc. 0.0011

04 cut/slim-caballote en aluminium pour pied banquette • 2 vis
cut/slim caballote de aluminio para pata bancada + n.2 tornillos

code	finishing	q.kit	q.pack	a	b	kg.x1	vol.x1
111704-222	● aluminium/aluminio	x1	10	60	95	0,40	mc. 0.0012

05 slim-pied en aluminium pour banquette • 2 pieds
slim-pata de aluminio para bancada + n.2 pies

code	finishing	q.kit	q.pack	a	b	kg.x1	vol.x1
111704-226	● aluminium/aluminio	x2	5	610	350	1,20	mc. 0.014

06 cut-pied en aluminium pour banquette • 2 pieds
cut-pata de aluminio para bancada + n.2 pies

code	finishing	q.kit	q.pack	a	b	kg.x1	vol.x1
111704-224	● aluminium/aluminio	x2	5	610	350	2,55	mc. 0.014

07 embout couvre-tête rectangulaire 80x40 noir
tapón embellecedor rectangular 80 x 40 negro

code	finishing	q.kit
134103-001	● noir/negro	x2

08 90t(03) poutre pour banquette 80x40
90t(03) viga para bancada 80x40

code	finishing	places/asientos	q.kit	q.pack	a	b	c	kg.x1	vol.x1
110703-190	● noir/negro	2 places/2 asientos	x1	1	1160	80	40	3,20	mc. 0.0045
110704-090	● gris/gris	2 places/2 asientos	x1	1	1160	80	40	3,20	mc. 0.0045
110703-191	● noir/negro	3 places/3 asientos	x1	1	1710	80	40	4,71	mc. 0.005
110704-091	● gris/gris	3 places/3 asientos	x1	1	1710	80	40	4,71	mc. 0.005
110703-192	● noir/negro	4 places/4 asientos	x1	1	2260	80	40	6,22	mc. 0.0085
110704-092	● gris/gris	4 places/4 asientos	x1	1	2260	80	40	6,22	mc. 0.0085
110703-193	● noir/negro	5 places/5 asientos	x1	1	2800	80	40	7,72	mc. 0.01
110704-193	● gris/gris	5 places/5 asientos	x1	1	2800	80	40	7,72	mc. 0.01

09 90cv-cavalier pour dessous poutre
90cv-caballote bajo viga

code	finishing	q.kit	q.pack	a	b	kg.x1	vol.x1
110703-007	● noir/negro	x1	50	55	65	0,60	mc. 0.0005
110704-016	● gris/gris	x1	50	55	65	0,60	mc. 0.0005

10 pack vis m8x12 tête cylindrique hexagonale encaissée brunie noire
paquete de tornillos m8x12 cabeza cilindrica hexagonal embutida bruñida negro

code	finishing	q.kit	q.pack
117003-070	● noir/negro	x4	200

11 cut/slim-cavalier en aluminium pour accoudoir banquette
cut/slim caballote de aluminio para brazo bancada

code	finishing	q.kit	q.pack	a	b	kg.x1	vol.x1
111704-221	● aluminium/aluminio	x1	10	58	95	0,32	mc. 0.0012

for the bench components, see page 417

nexus

4-legs

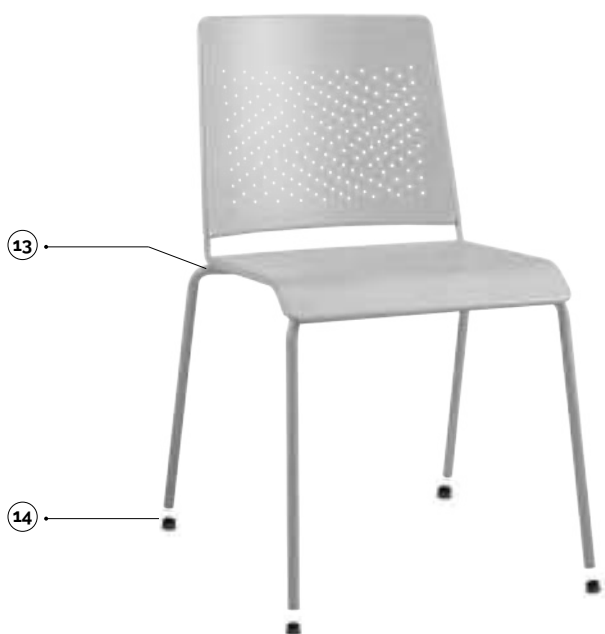

Corten ● *Une caractéristique spécifique du Corten est la variabilité dans la tonalité de la finition.
* Una característica particular del Corten es la variabilidad en la tonalidad del acabado.

13 14

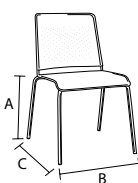

13

13 nexus-châssis 4 pieds avec coque en tôle
nexus-estructura 4 patas con carcasa de chapa

code	finishing	q.kit	q.pack	a	b	c	kg.x1	vol.x1
112603-070	● noir/negro	x1	50	450	530	540	9,80	mc. 0,04
112604-070	● gris/gris	x1	50	450	530	540	9,80	mc. 0,04
112605-070	○ blanc/blanco ral9010	x1	50	450	530	540	9,80	mc. 0,04
112607-070	● corten*	x1	50	450	530	540	9,80	mc. 0,04

14 embout à ailettes rond d.18 noir
tacos redondos con aletas d.18 negro

code	finishing	q.kit	q.pack
137003-072	● noir/negro	x4	200

main component sizes



nexus-chariot porte-chaises noir avec accessoires
nexus-carro para sillas con accesorios negro

code	finishing	q.kit
110803-342	● noir/negro	x1





ala



discover more about
Ala Collection

Le banc Ala, disponible dans les versions 2, 3, 4 et 5 positions, est la synthèse de l'élégance et de la robustesse. Disponible en plusieurs combinaisons de couleurs, il peut également être personnalisé en insérant une table latérale entre les sièges, adaptée au support de magazines, brochures, sacs et accessoires. Parfait pour les grandes salles d'attente, avec la version la plus longue, ainsi que pour les espaces plus restreints, où il s'intègre parfaitement. L'assise et le dossier peuvent également être rembourrés.

El banco Ala, disponible en versiones de 2, 3, 4 y 5 posiciones, es la síntesis de elegancia y solidez.

Disponible en varias combinaciones de colores, también se puede personalizar con la inserción de una mesa lateral entre los asientos, adecuada para apoyar revistas, folletos, bolsos y accesorios. Perfecta tanto para grandes salas de espera, con la versión más larga, como para espacios más reducidos, donde se encaja a la perfección. El asiento y el respaldo también pueden ser tapizado.

Plus

- Disponible en 3 couleurs.
- Configurations 2 - 3 - 4 - 5 sièges.
- Facile à assembler.
- *Disponible en 3 colores.*
- *Configuraciones de 2 - 3 - 4 - 5 asientos.*
- *Fácil para montar.*

ala

bench



la banquette est fournie démontée dans tous ses composants

el banco se suministra en todos sus componentes desmontado

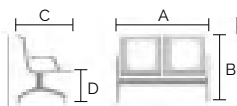

01 banquette deux places avec deux accoudoirs

banco 2 plazas con dos reposabrazos

code	finishing	q.kit	q.pack	a	b	c	d	kg.x1	vol.x1
110703-150	● noir/negro	x1	5	1200	800	680	410	32.00	mc. 0.005
110704-150	● gris/gris	x1	5	1200	800	680	410	32.00	mc. 0.005
110702-150	● bordeaux/bordeaux	x1	5	1200	800	680	410	32.00	mc. 0.005



la banquette est fournie démontée dans tous ses composants

el banco se suministra en todos sus componentes desmontado

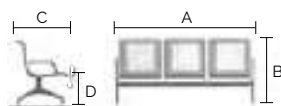

02 banquette trois places avec deux accoudoirs

banco 3 plazas con dos reposabrazos

code	finishing	q.kit	q.pack	a	b	c	d	kg.x1	vol.x1
110703-152	● noir/negro	x1	5	1800	800	680	410	45.00	mc. 0.115
110704-152	● gris/gris	x1	5	1800	800	680	410	45.00	mc. 0.115
110702-152	● bordeaux/bordeaux	x1	5	1800	800	680	410	45.00	mc. 0.115



la banquette est fournie démontée dans tous ses composants

el banco se suministra en todos sus componentes desmontado

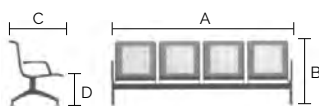

03 banquette quatre places avec deux accoudoirs

banco 4 plazas con dos reposabrazos

code	finishing	q.kit	q.pack	a	b	c	d	kg.x1	vol.x1
110703-154	● noir/negro	x1	5	2380	800	680	410	58.00	mc. 0.15
110704-154	● gris/gris	x1	5	2380	800	680	410	58.00	mc. 0.15
110702-154	● bordeaux/bordeaux	x1	5	2380	800	680	410	58.00	mc. 0.15



la banquette est fournie démontée dans tous ses composants

el banco se suministra en todos sus componentes desmontado

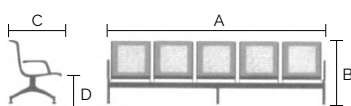

04 banquette cinq places avec deux accoudoirs

banco 5 plazas con dos reposabrazos

code	finishing	q.kit	q.pack	a	b	c	d	kg.x1	vol.x1
110703-156	● noir/negro	x1	5	2960	800	680	410	72.00	mc. 0.17
110704-156	● gris/gris	x1	5	2960	800	680	410	72.00	mc. 0.17
110702-156	● bordeaux/bordeaux	x1	5	2960	800	680	410	72.00	mc. 0.17

ala

bench

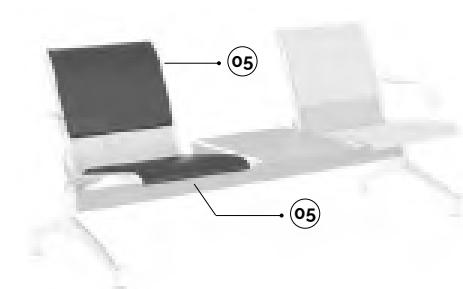

05 assise et dossier en simili-cuir avec vis
panel de asiento y respaldo tapizado en polipiel con tornillos

code	finishing	q.kit	q.pack	kg.x1	vol.x1
143903-001	● noir/negro	x1	5	2,30	mc. 0,008
143904-001	● gris/gris	x1	5	2,30	mc. 0,008
143902-001	● bordeaux/bordeaux	x1	5	2,30	mc. 0,008

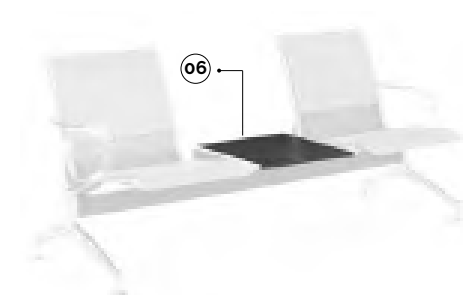

06 table en metal pour banquette avec vis
mesa de banco en chapa con tornillos

code	finishing	q.kit	q.pack	kg.x1	vol.x1
110703-151	● noir/negro	x1	5	4,16	mc. 0,01
110704-151	● gris/gris	x1	5	4,16	mc. 0,01
110702-151	● bordeaux/bordeaux	x1	5	4,16	mc. 0,01



siton



discover more about
Siton Collection

Un banc muni d'une assise rabattable. Réalisé pour des contextes où l'on ne peut pas renoncer à l'élégance, Siton présente un mécanisme en aluminium permettant à l'assise de se rabattre. Ce modèle a été dessiné et réalisé pour représenter un élément unique et stylisé.

Siton est idéal pour les auditoriums et les salles de conférence les plus prestigieuses.

La bancada con asientos abatibles. Siton, pensada para todas aquellas situaciones donde no se quiere renunciar a la elegancia, presenta un mecanismo de aluminio para el asiento abatible, diseñado y realizado para ser también un elemento de estilo.

Siton es ideal para los auditorios y las salas de congresos de mayor prestigio.

Plus

- Un design caractéristique.
- *Diseño distintivo.*
- Un mécanisme rabattable en aluminium.
- *Mecanismo de aluminio abatible.*



designed by:
Esdra

siton

bench

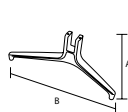
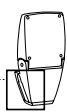
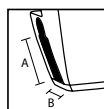
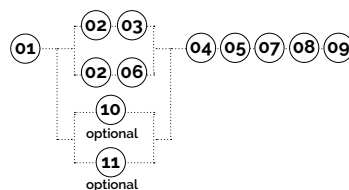

01

02

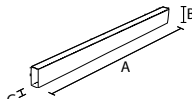

03

04



05

06

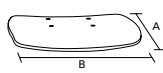

07

08



09

main component sizes

01 siton-mécanisme banquette rabattable en aluminium poli
siton-mecanismo bancada abatible de aluminio brillante

code	finishing	q.kit	q.pack	a	b	kg.x1	vol.x1
110704-180	● aluminium/aluminio	x1	4	80	40	2.81	mc. 0.007

02 siton-pied long en aluminium pour banquette
siton-pata larga de aluminio para bancada

code	finishing	q.kit	q.pack	a	b	kg.x1	vol.x1
110704-171	● aluminium/aluminio	x2	5	305	643	2.80	mc. 0.014

03 siton-accoudoir en aluminium pour banquette
siton-brazo de aluminio para bancada

code	finishing	q.kit	q.pack	a	b	kg.x1	vol.x1
111704-030	● aluminium/aluminio	x1	10	280	303	1.30	mc. 0.0011

04 got(03) poutre pour banquette 80x40
got(03) viga para bancada 80x40

code	finishing	q.kit	q.pack	a	b	c	kg.x1	vol.x1	
110703-190	● noir/negro	2 places/2 asientos	x1	1	1160	80	40	3.20	mc. 0.0045
110704-190	● gris/gris	2 places/2 asientos	x1	1	1160	80	40	3.20	mc. 0.0045
110703-191	● noir/negro	3 places/3 asientos	x1	1	1710	80	40	4.71	mc. 0.005
110704-191	● gris/gris	3 places/3 asientos	x1	1	1710	80	40	4.71	mc. 0.005
110703-192	● noir/negro	4 places/4 asientos	x1	1	2260	80	40	6.22	mc. 0.0085
110704-192	● gris/gris	4 places/4 asientos	x1	1	2260	80	40	6.22	mc. 0.0085
110703-193	● noir/negro	5 places/5 asientos	x1	1	2800	80	40	7.72	mc. 0.01
110704-193	● gris/gris	5 places/5 asientos	x1	1	2800	80	40	7.72	mc. 0.01

05 siton-cavalier en aluminium 80x40 pour accoudoir banquette
siton-caballette de aluminio 80x 40 para brazo bancada

code	finishing	q.kit	q.pack	kg.x1	vol.x1
111704-031	● aluminium/aluminio	x1	10	0.485	mc. 0.0012

06 siton-capuchon en aluminium pour pied banquette
siton-tapa de aluminio para pata bancada

code	finishing	q.kit	q.pack	kg.x1	vol.x1
110704-172	● aluminium/aluminio	x2	10	0.113	mc. 0.0002

07 siton-dix boites de prêt-à-monter accessoires pour pieds banquette
siton-kit de diez paquetes de accesorios para pata bancada

code	finishing	q.kit	q.pack	kg.x1	vol.x1
137000-005	● aluminium/aluminio	x1	1	0.85	mc. 0.004

08 siton-siège pour banquette rabattable en bois verni + 4 têtes et 4 vis fixation
siton-asiento para bancada abatible de madera pintada + 4 terminales y 4 tornillos de fijación

code	finishing	q.kit	q.pack	a	b	kg.x1	vol.x1
122207-030	● hêtre/haya	x1	10	420	400	1.40	mc. 0.01
122207-031	● wengé/wengé	x1	10	420	400	1.40	mc. 0.01

09 siton-dossier pour banquette rabattable en bois verni + 4 vis fixation
siton-respaldo para bancada abatible de madera pintada + 4 tornillos de fijación

code	finishing	q.kit	q.pack	a	b	kg.x1	vol.x1
122107-030	● hêtre/haya	x1	10	690	460	3.30	mc. 0.02
122107-031	● wengé/wengé	x1	10	690	460	3.30	mc. 0.02

siton

bench leg options

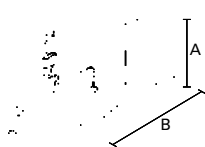

10 90gm(02)-pied mobile pour banquette avec accessoires
90gm(02)-pata móvil para bancada con accesorios

code	finishing	q.kit	q.pack	a	b	kg.x1	vol.x1
110703-120	● noir/negro	x2	2	320	600	2,70	mc. 0,0012
110704-099	● gris/gris	x2	2	320	600	2,70	mc. 0,0012
110710-007	● chromé/cromado	x2	2	320	600	2,70	mc. 0,0012

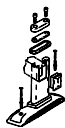
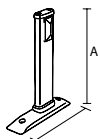

11 90gf(02)-pied fixe pour banquette avec accessoires
90gf(02)-pata fija para bancada con accesorios

code	finishing	q.kit	q.pack	a	b	kg.x1	vol.x1
110703-122	● noir/negro	x2	2	320	310	1,80	mc. 0,0012
110704-107	● gris/gris	x2	2	320	310	1,80	mc. 0,0012





duetto



discover more about
Duetto Collection

Duetto: un système de coques innovant à encastrement.

Une grande polyvalence lors de la composition du dossier et de l'assise, avec la possibilité de mélanger les couleurs, une fonctionnalité absolue et un design minimaliste, grâce à l'absence d'accessoires de montage. Le panneau en bois multicouche à tapisser est en option sur tous les châssis.

Ce modèle est également proposé dans une version tabouret avec deux hauteurs : 730 mm et 630 mm.

Duetto s'adapte aux environnements domestiques et professionnels.

Duetto, el sistema innovador de carcadas de encastrado.

Máxima versatilidad de composición para respaldo y asiento, posibilidad de combinar sus colores, funcionalidad absoluta y diseño minimalista por la ausencia de accesorios para el montaje. Opcional para todas las estructuras: la galleta de madera contrachapada tapizable.

Disponible también la versión taburete en dos alturas: 730 mm y 630 mm.

Duetto se adapta a los ambientes de la casa y del contract.

Plus

- Possibilité d'avoir deux pièces en une en mélangeant les couleurs grâce à un système innovant d'encastrement entre les coques.
- Design minimaliste et fin.
- Une grande variété de couleurs à la mode.
- Facile à soulever grâce à un trou au milieu.
- Pratique à empiler dans sa version traîneau et 4 pieds.
- Certification EN 16139:2013 de Niveau 1.
- *Dos piezas en una, combinando sus colores mediante el sistema innovador de encastrado para las carcadas.*
- *Minimalist slimline design.*
- *Versatilidad extrema de colores de moda.*
- *Fácil de levantar con el orificio central.*
- *Cómodamente apilable en la versión de patin y de 4 patas.*
- *Certificación EN 16139:2013 Nivel 1.*



**trolley
available**



**certified
product**

duetto

slide



CERTIFIED BY
CATAS



plastic colours

- bleu/azul ral 5014
- noir/negro
- gris/gris ral 7003
- blanc/blanco 218
- rouge/rojo 527

main component sizes

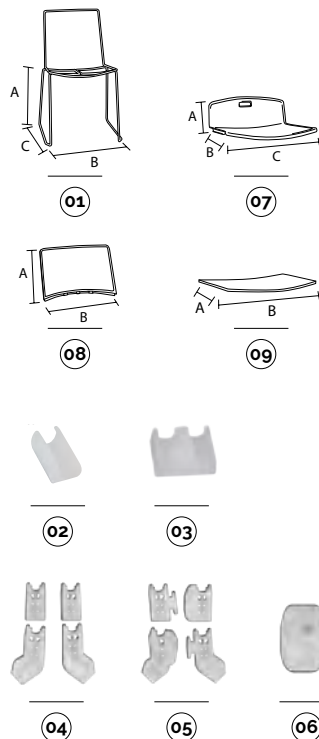

optionals

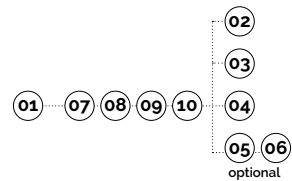

01 duetto-châssis coulissant tige d.11 duetto-estructura patin de varilla d. 11

code	finishing	q.kit	q.pack	a	b	c	kg.x1	vol.x1
113410-046	● chromé/cromado	x1	100	450	510	480	4,40	mc. 0.02

02 base plate clipsage en pe pour tube base plana con pinza de pe para varilla

code	finishing	q.kit	q.pack
137006-070	○ neutre/neutro	x4	200

03 base plate double clipsage en pe pour tube d'union chaises base plana con pinza double de pe para varilla para unión sillas

code	finishing	q.kit
134006-021	○ neutre/neutro	x4

04 btf-kit pieds btf-kit pies

code	finishing	q.kit	q.pack	kg.x1
134306-001	○ neutre/neutro	x1	100	0,05

05 btf-kit pieds avec crochets btf-kit pies con ganchos

code	finishing	q.kit	q.pack	kg.x1
134306-002	○ neutre/neutro	x1	100	0,06

06 pptf-embout pour fixation au sol pptf-tapón para fijación en el pavimento

code	finishing	q.kit	q.pack	kg.x1
134306-003	○ neutre/neutro	x2	100	0,03

07 duetto-siège en plastique coloré + pf1 duetto-asiento base de plástico de color + pf1

code	finishing	q.kit	q.pack	a	b	c	kg.x1	vol.x1
132203-022	● noir/negro	x1	10	180	390	430	0,80	mc. 0.09

08 duetto-dossier en plastique coloré duetto-respaldo de plástico de color

code	finishing	q.kit	q.pack	a	b	kg.x1	vol.x1
132103-022	● noir/negro	x1	20	280	395	0,40	mc. 0.03

09 duetto-panneau siège multicouches avec 6 boulons m6 duetto-galleta asiento de contrachapado con 6 remaches m6

code	finishing	q.kit	q.pack	a	b	kg.x1	vol.x1
122207-019	● hêtre/haya	x1	20	395	410	0,74	mc. 0.003

10 duetto-vis tbl combi m6x8 zinguée blanche (vis pour fixation panneau) duetto-tornillo tbl combi m6x8 dent. galvanizado blanco (tornillo para fijación galleta)

code	finishing	q.kit
117711-207	○ zinguée blanc/galvanizado blanco	x6

for all colour codes, see page 288

duetto

stool



plastic colours

- bleu/azul ral 5014
- noir/negro
- gris/gris ral 7003
- blanc/blanco 218
- rouge/rojo 527

main component sizes

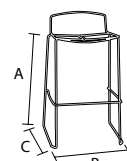

optionals

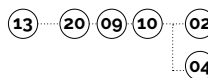

h.630	13 duetto-tabouret haut h.630 tige d.11 duetto-taburete alto h.630 de varilla d.11							
	code finishing	q.kit	q.pack	a	b	c	kg.x1	vol.x1
	113410-048 ● chromé/cromado	x1	50	630	525	500	5,70	mc. 0.04
h.730	13 duetto-tabouret haut h.730 tige d.11 duetto-taburete alto h.730 de varilla d.11							
	code finishing	q.kit	q.pack	a	b	c	kg.x1	vol.x1
	113410-049 ● chromé/cromado	x1	50	730	525	500	6,00	mc. 0.04
	02 base plate clipsage en pe pour tube base plana con pinza de pe para varilla							
	code finishing	q.kit	q.pack					
	137006-070 ○ neutre/neutro	x4	200					
	04 btf-kit pieds btf-kit pies							
	code finishing	q.kit	q.pack				kg.x1	
	134306-001 ○ neutre/neutro	x1	100				0,05	
	20 duetto-siège en plastique coloré + pf1 duetto-asiento base de plástico de color + pf1							
	code finishing	q.kit	q.pack	a	b	c	kg.x1	vol.x1
	132203-028 ● noir/negro	x1	10	180	390	430	0,80	mc. 0.09
	09 duetto-panneau siège multicouches avec 6 boulons m6 duetto-galleta asiento de contrachapado con 6 remaches m6							
	code finishing	q.kit	q.pack	a	b		kg.x1	vol.x1
	122207-019 ● hêtre/haya	x1	20	395	410		0,74	mc. 0.003
	10 duetto-vis tbl combi m6x8 zinguée blanche (vis pour fixation panneau) duetto-tornillo tbl combi m6x8 dent. galvanizado blanco (tornillo para fijación galleta)							
	code finishing	q.kit						
	117711-207 ○ zinguée blanc/galvanizado blanco	x6						



for all colour codes, see page 288

duetto

4-legs



plastic colours

- bleu/azul ral 5014
- noir/negro
- gris/gris ral 7003
- blanc/blanco 218
- rouge/rojo 527

main component sizes

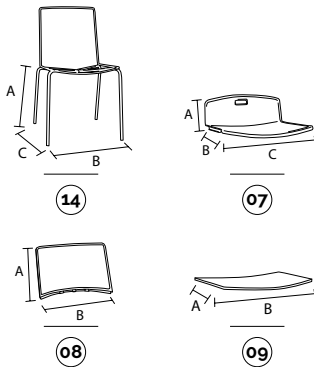

14 07 08 09 10 15

14 duetto-châssis 4 pieds tube d.16 sans embouts duetto-estructura 4 patas tubular d.16 sin tapones

code	finishing	q.kit	q.pack	a	b	c	kg.x1	vol.x1
112710-036	● chromé/cromado	x1	100	450	510	480	3,70	mc. 0.02
112703-036	● noir/negro	x1	100	450	510	480	3,70	mc. 0.02
112704-036	● gris/gris ikea 4	x1	100	450	510	480	3,70	mc. 0.02
112705-036	○ ivoire/marfil ral1013	x1	100	450	510	480	3,70	mc. 0.02

15 embouts ronds d.16 tacos redondos con aletas d.16

code	finishing	q.kit
134203-160	● noir/negro	x4

07 duetto-siège en plastique coloré + pfi duetto-asiento base de plástico de color + pfi

code	finishing	q.kit	q.pack	a	b	c	kg.x1	vol.x1
132203-022	● noir/negro	x1	10	180	390	430	0,80	mc. 0.09

08 duetto-dossier en plastique coloré duetto-respaldo de plástico de color

code	finishing	q.kit	q.pack	a	b	kg.x1	vol.x1
132103-022	● noir/negro	x1	20	280	395	0,40	mc. 0.03

09 duetto-panneau siège multicouches avec 6 boulons m6 duetto-galleta asiento de contrachapado con 6 remaches m6

code	finishing	q.kit	q.pack	a	b	kg.x1	vol.x1
122207-019	● hêtre/haya	x1	20	395	410	0,74	mc. 0.003

10 duetto-vis tbl combi m6x8 zinguée blanche (vis pour fixation panneau) duetto-tornillo tbl combi m6x8 dent, galvanizado blanco (tornillo para fijación galleta)

code	finishing	q.kit
117711-207	○ zinguée blanc/galvanizado blanco	x6



for all colour codes, see page 288



duetto-chariot porte-chaises noir avec accessoires duetto-carro para sillas con accesorios negro

code	finishing	q.kit
110803-373	● noir/negro	x1

duetto

bench



plastic colours

- bleu/azul ral 5014
- noir/negro
- gris/gris ral 7003
- blanc/blanco 218
- rouge/rojo 527

19 07 08 09 10

main component sizes

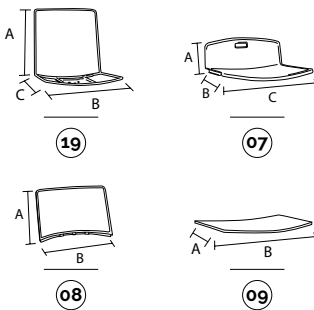

19 duetto-support pour raccordement coque duetto sur banquette
duetto-soporte para enganchar carcasa duetto en bancada

code	finishing	q.kit	q.pack	a	b	c	kg.x1	vol.x1
110710-018	● chromé/cromado	x1	100	400	430	390	3,70	mc. 0.02

07 duetto-siège en plastique coloré + pf1
duetto-asiento base de plástico de color + pf1

code	finishing	q.kit	q.pack	a	b	c	kg.x1	vol.x1
132203-022	● noir/negro	x1	10	180	390	430	0,80	mc. 0.09

08 duetto-dossier en plastique coloré
duetto-respaldo de plástico de color

code	finishing	q.kit	q.pack	a	b	kg.x1	vol.x1
132103-022	● noir/negro	x1	20	280	395	0,40	mc. 0.03

09 duetto-panneau siège multicouches avec 6 boulons m6
duetto-galleta asiento de contrachapado con 6 remaches m6

code	finishing	q.kit	q.pack	a	b	kg.x1	vol.x1
122207-019	● hêtre/haya	x1	20	395	410	0,74	mc. 0.003

10 duetto-vis tbl combi m6x8 zinguée blanche (vis pour fixation panneau)
duetto-tornillo tbl combi m6x8 dent. galvanizado blanco (tornillo para fijación galleta)

code	finishing	q.kit
117711-207	○ zinguée blanc/galvanizado blanco	x6

for the bench components, see page 417



for all colour codes, see page 288

optionals

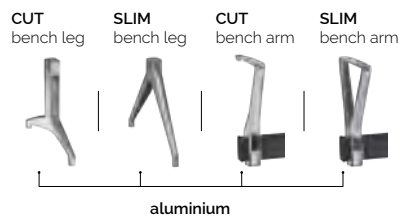

duetto

optional colour codes



plastic colour codes



07 assise en plastique
asiento de plástico

- 132215-022 bleu/azul ral 5014
- 132203-022 noir/negro
- 132204-022 gris/gris ral 7003
- 132205-022 blanc/blanco 218
- 132202-022 rouge/rojo 527



08 dossier en plastique
respaldo de plástico

- 132115-022 bleu/azul ral 5014
- 132103-022 noir/negro
- 132104-022 gris/gris ral 7003
- 132105-022 blanc/blanco 218
- 132102-022 rouge/rojo 527



12 accoudoirs en plastique
brazos de plástico

- 131715-075 bleu/azul ral 5014
- 131703-075 noir/negro
- 131704-075 gris/gris ral 7003
- 131705-075 blanc/blanco 218
- 131702-075 rouge/rojo 527



20 assise en plastique pour tabouret
asiento de plástico para taburete

- 132215-028 bleu/azul ral 5014
- 132203-028 noir/negro
- 132204-028 gris/gris ral 7003
- 132205-028 blanc/blanco 218
- 132202-028 rouge/rojo 527

indications de couleur plastique
indicaciones de color de plástico

- multipli per scatola/multiples per box
- ● ● ● Moq. 250 pz.







manila



discover more about
Manila Collection

Une monocoque en plastique avec des accoudoirs intégrés. Une large assise, confortable et robuste, au design fin et caractéristique, avec des accoudoirs dessinés pour l'envelopper. Elle est adaptable à tout type d'environnement grâce au riche assortiment de châssis offerts en option et aux nombreuses finitions.

Manila a été réalisée pour l'aménagement de tout type d'environnement accueillant le public et est parfaitement adaptée pour un bureau.

La monocoque en plastique con brazos integrados. Un asiento amplio, cómodo y resistente, con un diseño esbelto y distintivo y brazos diseñados para abrazarla. Resulta sumamente versátil con su rico surtido de estructuras, opcionales también en varios acabados.

Manila se ha creado para amueblar todos los ambientes de la comunidad y se adapta perfectamente a los ambientes de oficina.

Plus

- Des dimensions généreuses et une coque très confortable.
- Un design caractéristique grâce aux accoudoirs intégrés et une coque unique.
- 6 couleurs de tendance sont disponibles pour la coque.
- Une polyvalence maximale.
- Le petit panneau en bois à tapisser peut être demandé en option.
- Dimensiones grandes y máximo confort de la carcasa.
- Diseño distintivo con los brazos integrados y la carcasa única.
- 6 colores de moda para la carcasa.
- Máxima versatilidad.
- Galleta de madera tapizable como opcional.

manila

slide



plastic colours

- rouge/rojo p1797u
- gris/gris warm grey 6c
- ivoire/marfil ral1013
- brun/marrón ral69g
- jaune/amarillo ral110u
- bleu/azul ral5014

main component sizes

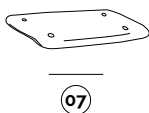
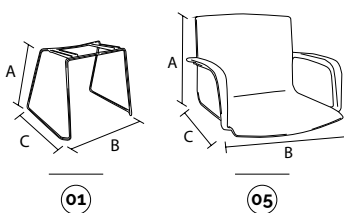

optionals

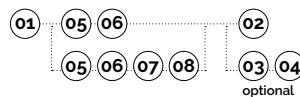
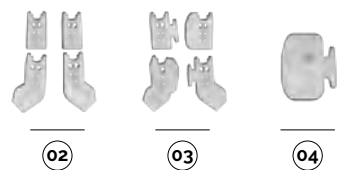

01 manila-châssis coulissant tige d.12 manila-estructura patin de varilla d. 12

code	finishing	q.kit	q.pack	a	b	c	kg.x1	vol.x1
113403-333	● noir/negro	x1	100	445	580	495	4,00	mc. 0,026
113405-333	○ ivoire/marfil ral1013	x1	100	445	580	495	4,00	mc. 0,026
113410-333	● chromé/cromado	x1	100	445	580	495	4,00	mc. 0,026

02 btf-kit pieds btf-kit pies

code	finishing	q.kit	q.pack	kg.x1
134306-001	○ neutre/neutro	x1	100	0,05

03 btfa-kit pieds avec crochets btfa-kit pies con ganchos

code	finishing	q.kit	q.pack	kg.x1
134306-002	○ neutre/neutro	x1	100	0,06

04 pptf-embout pour fixation au sol pptf-tapón para fijación en el pavimento

code	finishing	q.kit	q.pack	kg.x1
134306-003	○ neutre/neutro	x2	100	0,03

05 manila-coque entière avec accoudoirs manila-estructura completa con brazos

code	finishing	q.kit	q.pack	a	b	c	kg.x1	vol.x1
133904-045	● gris/gris warm grey 6c	x1	5	390	580	480	2,60	mc. 0,05

06 manila-vis tc+combi 6x16 tête cylindrique zinguée en croix (vis pour fixation coque) manila-tornillo tc+combi 6x16 cabeza cilíndrica en cruz galvanizado (tornillo para fijación carcasa)

code	finishing	q.kit
117811-181	● zinguée/galvanizado	x4

07 manila-panneau assise multicouches avec 6 boulons m6 manila-galleta asiento de contrachapado con 6 remaches m6

code	finishing	q.kit	q.pack	kg.x1	vol.x1
122207-034	● hêtre/haya	x1	20	0,78	mc. 0,003

08 manila-vis tbl combi m6x12 zinguée blanche (vis pour fixation panneau) manila-tornillo tbl combi m6x12 galvanizado blanco (tornillo para fijación galleta)

code	finishing	q.kit
117711-206	○ zinguée blanc/galvanizado blanco	x6



manila

slide



plastic colours

- rouge/rojo p1797u
- gris/gris warm grey 6c
- ivoire/marfil ral1013
- brun/marrón ral69g
- jaune/amarillo ral110u
- bleu/azul ral5014

main component sizes

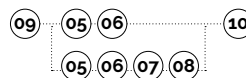
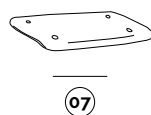
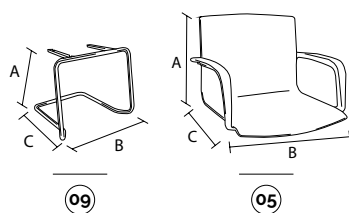

09 manila-base coulissante tube asform d.22 embouts exclus
manila-base patin tubular asform d. 22 tapones excluidos

code	finishing	q.kit	q.pack	a	b	c	kg.x1	vol.x1
110503-417	● noir/negro	x1	64	450	545	545	4.10	mc. 0.0313
110504-417	● gris/gris ig2621	x1	64	450	545	545	4.10	mc. 0.0313
110505-417	○ ivoire/marfil ral1013	x1	64	450	545	545	4.10	mc. 0.0313
110510-417	● chromé/cromado	x1	64	450	545	545	4.10	mc. 0.0313

10 p2p-pince deux broches en polyéthylène noire
p2p-pinza dos ganchos de polietileno negra

code	finishing	q.kit
134003-003	● noir/negro	x6

05 manila-coque entière avec accoudoirs
manila-estructura completa con brazos

code	finishing	q.kit	q.pack	a	b	c	kg.x1	vol.x1
133904-045	● gris/gris warm grey 6c	x1	5	390	580	480	2.60	mc. 0.05

06 manila-vis tc-combi 6x16 tête cylindrique zinguée en croix (vis pour fixation coque)
manila-tornillo tc-combi 6x16 cabeza cilíndrica en cruz galvanizado (tornillo para fijación carcasa)

code	finishing	q.kit
117811-181	● zinguée/galvanizado	x4

07 manila-panneau assise multicouches avec 6 boulons m6
manila-galleta asiento de contrachapado con 6 remaches m6

code	finishing	q.kit	q.pack	kg.x1	vol.x1
122207-034	● hêtre/haya	x1	20	0,78	mc. 0,003

08 manila-vis tbl combi m6x12 zinguée blanche (vis pour fixation panneau)
manila-tornillo tbl combi m6x12 galvanizado blanco (tornillo para fijación galleta)

code	finishing	q.kit
117711-206	○ zinguée blanc/galvanizado blanco	x6



for all colour codes, see page 297



manila

4-legs



plastic colours

- rouge/rojo p1797u
- gris/gris warm grey 6c
- ivoire/marfil ral1013
- brun/marrón ral69g
- jaune/amarillo ral110u
- bleu/azul ral5014

main component sizes

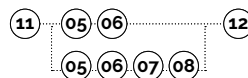
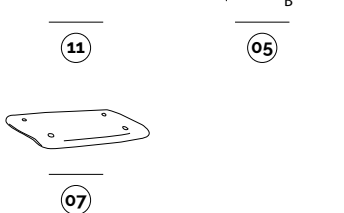
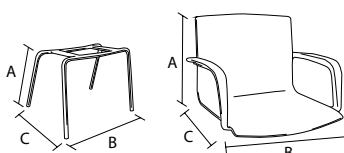

11 manila-châssis 4 pieds d.22 sans embouts

manila-estructura 4 patas d. 22 sin tapones

code	finishing	q.kit	q.pack	a	b	c	kg.x1	vol.x1
110103-259	● noir/negro	x1	80	440	585	490	2,70	mc. 0.035
110104-259	● gris/gris ig2621	x1	80	440	585	490	2,70	mc. 0.035
110105-259	○ ivoire/marfil ral1013	x1	80	440	585	490	2,70	mc. 0.035
110110-259	● chromé/cromado	x1	80	440	585	490	2,70	mc. 0.035

12 embout d.22 tête sphérique noire

tapón d.22 cabeza esférica negro

code	finishing	q.kit
134203-224	● noir/negro	x4

05 manila-coque entière avec accoudoirs

manila-estructura completa con brazos

code	finishing	q.kit	q.pack	a	b	c	kg.x1	vol.x1
133904-045	● gris/gris warm grey 6c	x1	5	390	580	480	2,60	mc. 0.05

06 manila-vis tc+combi 6x16 tête cylindrique zinguée en croix (vis pour fixation coque)

manila-tornillo tc+combi 6x16 cabeza cilíndrica en cruz galvanizado (tornillo para fijación carcasa)

code	finishing	q.kit
117811-181	● zinguée/galvanizado	x4

07 manila-panneau assise multicouches avec 6 boulons m6

manila-galleta asiento de contrachapado con 6 remaches m6

code	finishing	q.kit	q.pack	kg.x1	vol.x1
122207-034	● hêtre/haya	x1	20	0,78	mc. 0.003

08 manila-vis tbl combi m6x12 zinguée blanche (vis pour fixation panneau)

manila-tornillo tbl combi m6x12 galvanizado blanco (tornillo para fijación galleta)

code	finishing	q.kit
117711-206	○ zinguée blanc/galvanizado blanco	x6



for all colour codes, see page 297

manila

swivel



plastic colours

- rouge/rojo p1797u
- gris/gris warm grey 6c
- ivoire/marfil ral1013
- brun/marrón ral69g
- jaune/amarillo ral110u
- bleu/azul ral5014

main component sizes

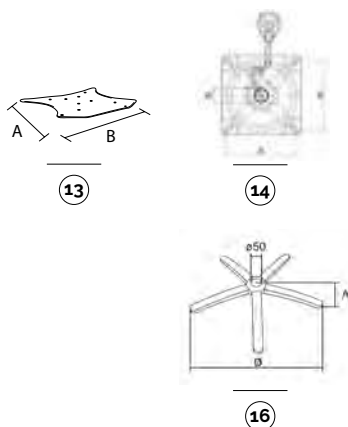

optionals

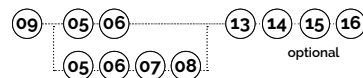
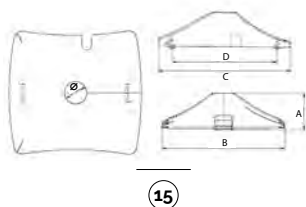

13 manila-châssis pour pivotant/banquette
manila-estructura para versión giratoria/bancada

code	finishing	q.kit	q.pack	a	b	kg.x1	vol.x1
110903-256	● noir/negro	x1	10	265	325	2,00	mc. 0.0019
110904-256	● gris/gris ig2621	x1	10	265	325	2,00	mc. 0.0019

14 pss28nr-plaque tabouret av/levier c/28 3" l4 noire
pss28nr- placa taburete con palanca c/28 3" l4 negra

code	finishing	q.kit	q.pack	a	b	ø	kg.x1	vol.x1
113003-104	● noir/negro	x1	25	150	150	28	1,23	mc. 0.002

15 cpg-couverture en plastique pour châssis pivotant
cpg-cubierta de plástico para estructura versión giratoria

code	finishing	q.kit	q.pack	a	b	c	d	ø	kg.x1	vol.x1
130903-000	● noir/negro	x1	50	60	200	210	167	36	0,1	mc. 0.0015

16 b40-base en métal avec cache-soudure
b40-base de metal con embellecedor soldadura

code	finishing	q.kit	q.pack	a	ø	kg.x1	vol.x1
110210-027	● chromé/cromado	x1	5	60	640	2,85	mc. 0.014

for the components below, see previous pages

05 06 07 08

CPG
plastic cover for swivel frame



for all colour codes, see page 297

manila

bench



plastic colours

- rouge/rojo p1797u
- gris/gris warm grey 6c
- ivoire/marfil ral1013
- brun/marrón ral69g
- jaune/amarillo ral110u
- bleu/azul ral5014

main component sizes

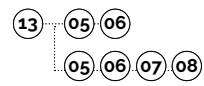
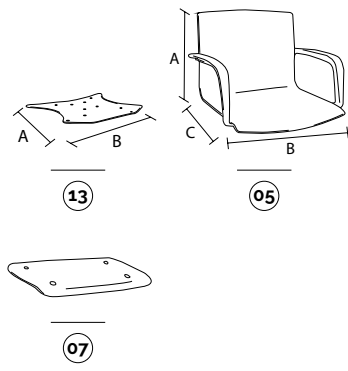

code	finishing	q.kit	q.pack	a	b	kg.x1	vol.x1
13	manila-châssis pour pivotant/banquette manila-estructura para versión giratoria/bancada						
110903-256	● noir/negro	x1	10	265	325	2,00	mc. 0,0019
110904-256	● gris/gris ig2621	x1	10	265	325	2,00	mc. 0,0019
05	manila-coque entière avec accoudoirs manila-estructura completa con brazos						
133904-045	● gris/gris warm grey 6c	x1	5	390	580 480	2,60	mc. 0,05
06	manila-vis tc+combi 6x16 tête cylindrique zinguée en croix (vis pour fixation coque) manila-tornillo tc+combi 6x16 cabeza cilíndrica en cruz galvanizado (tornillo para fijación carcasa)						
117811-181	● zinguée/galvanizado	x4					
07	manila-panneau assise multicouches avec 6 boulons m6 manila-galleta asiento de contrachapado con 6 remaches m6						
122207-034	● hêtre/haya	x1	20			0,78	mc. 0,003
08	manila-vis tbl combi m6x12 zinguée blanche (vis pour fixation panneau) manila-tornillo tbl combi m6x12 galvanizado blanco (tornillo para fijación galleta)						
117711-206	○ zinguée blanc/galvanizado blanco	x6					

for the components below, see previous pages

for all colour codes, see page 297

optionals

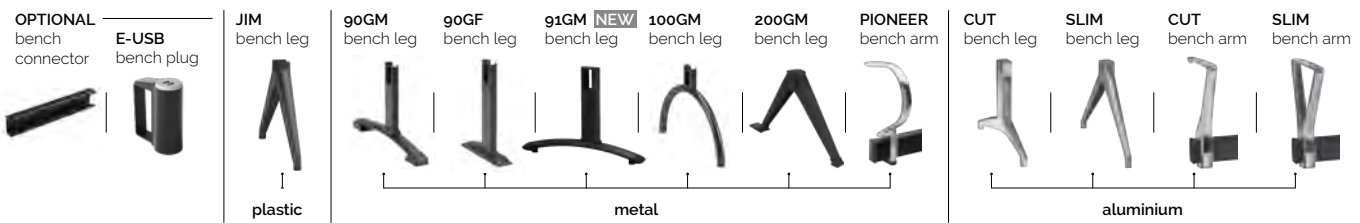

manila

optional colour codes



shell colour codes



05 coque entière en plastique
estructura completa en plástico

- 133902-045 rouge/rojo p1797u
- 133904-045 gris/gris warm grey 6c
- 133905-045 ivoire/marfil ral1013
- 133907-045 brun/marrón ral699
- 133908-045 jaune/amarillo ral110u
- 133915-045 bleu/azul ral5014





pluto



discover more about
Pluto Collection

Une monocoque au design moderne et essentiel.
Ce modèle extrêmement polyvalent et fonctionnel vante un style minimaliste, se caractérisant par un trou central particulier situé sur la monocoque. Plusieurs châssis peuvent être associés ; le petit panneau en plastique à tapisser ainsi que les crochets latéraux très pratiques sont en option.

Pluto est une bonne solution pour un environnement professionnel et à la maison.

La monocarcasa con un diseño moderno y esencial. Sumamente versátil y funcional, desprende un estilo minimalista, caracterizado por el orificio especial central de la monocarcasa. Varias estructuras combinables; opcionales: la galleta de plástico tapizable y los prácticos enganches laterales.

Pluto es una buena solución para los ambientes del contract y de la casa.

Plus

- Un design minimaliste dans 6 différentes couleurs de tendance.
- Une grande polyvalence grâce à une monocoque pouvant être associée à plusieurs types de châssis.
- En plastique pour l'outdoor.
- Empilable et grande facilité de nettoyage.
- Certification ANSI/BIFMA X5.1 (pour la version à 4 pieds, la certification n'est disponible qu'avec un châssis spécial de 2 mm d'épaisseur).
- *Diseño minimalista en 6 colores distintos de moda.*
- *Máxima versatilidad con la monocarcasa combinable con varios tipos de estructuras.*
- *Plásticos para el exterior.*
- *Apilable y muy fácil de limpiar.*
- *Certificación ANSI/BIFMA X5.1 (para la versión de 4 patas, la certificación sólo está disponible con una estructura especial de 2 mm de grosor).*



**plastic
protection**



**certified
product**

pluto

slide

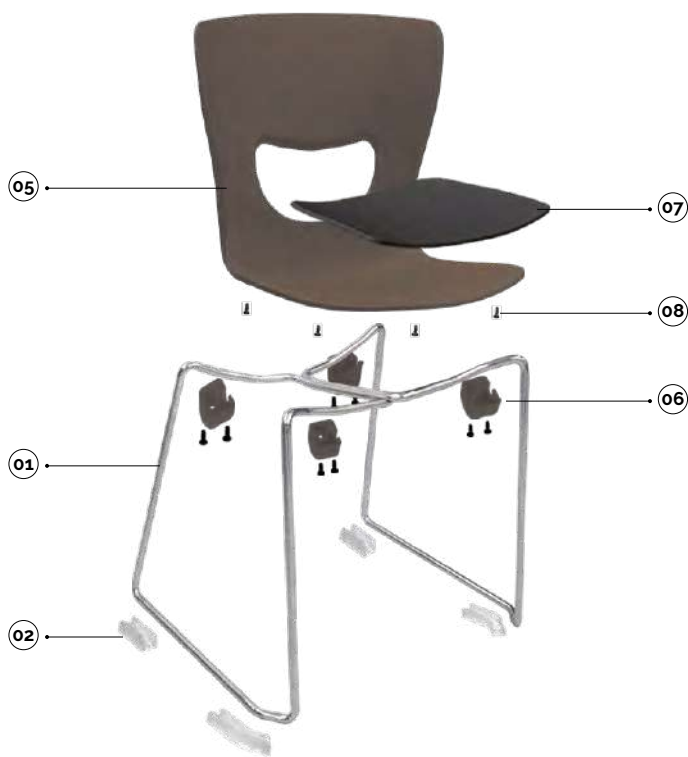

plastic colours

- rouge/rojo p1797u
- brun/marrón ral 8022
- gris/gris ral7003
- ivoire/marfil ral1013
- jaune/amarillo ral1012
- bleu/azul ral5014

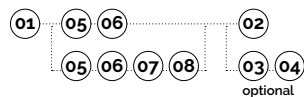

main component sizes

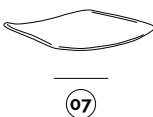
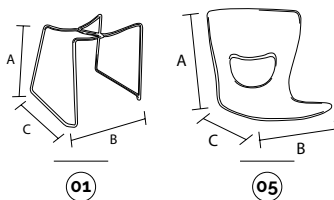

optionals

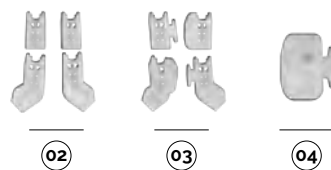

01 pluto-châssis coulissant tige d.12 pluto-estructura patin de varilla d. 12

code	finishing	q.kit	q.pack	a	b	c	kg.x1	vol.x1
113410-044	● chromé/cromado	x1	100	430	470	450	3,40	mc. 0.03

02 btf-kit pieds btf-kit pies

code	finishing	q.kit	q.pack	kg.x1
134306-001	○ neutre/neutro	x1	100	0,05

03 btfa-kit pieds avec crochets btfa-kit pies con ganchos

code	finishing	q.kit	q.pack	kg.x1
134306-002	○ neutre/neutro	x1	100	0,06

04 pptf-embout pour fixation au sol pptf-tapón para fijación en el pavimento

code	finishing	q.kit	q.pack	kg.x1
134306-003	○ neutre/neutro	x2	100	0,03

05 pluto-coque entière modèle pluto pluto-carcasa completa modelo pluto

code	finishing	q.kit	q.pack	a	b	c	kg.x1	vol.x1
133907-065	● brun/marrón ral8022	x1	10	420	435	435	1,946	mc. 0.02

06 pluto-pack accessoires pour coque pluto fil pluto-paquete de accesorios para carcasa pluto para varilla

code	finishing	q.kit	q.pack	kg.x1	vol.x1
137003-004	● brun/marrón ral8022	x1	10	châssis coulissant/estructura patin	0,085 mc. 0.001

07 pluto-panneau assise à tapisser pluto-panel asiento para tapizar

code	finishing	q.kit	q.pack	vol.x1
132203-047	● noir/negro	x1	20	mc. 0.003

08 pack vis tbl +fr 5x14 (pour panneau à revêtir) paquete de tornillos tbl +fr 5x14 (para galleta tapizable)

code	finishing	q.kit	q.pack
117003-071	● noir/negro	x4	200



for all colour codes, see page 305

pluto

4-legs



CERTIFIED BY
BIFMA

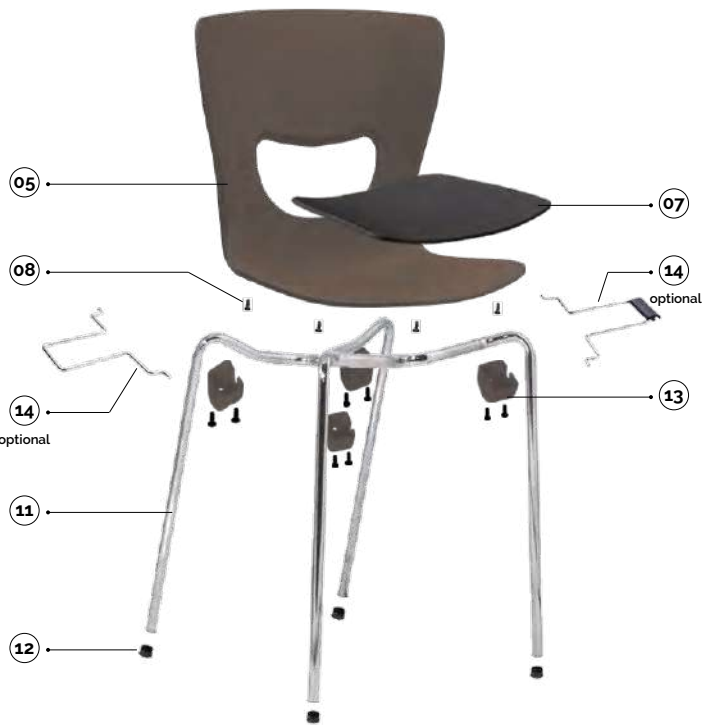

plastic colours

- rouge/rojo p1797u
- brun/marrón ral 8022
- gris/gris ral7003
- ivoire/marfil ral1013
- jaune/amarillo ral1012
- bleu/azul ral5014

main component sizes

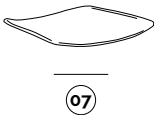
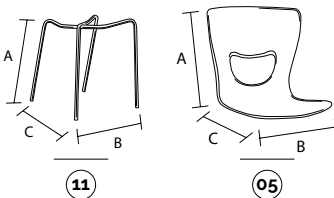

optionals

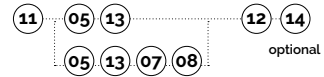
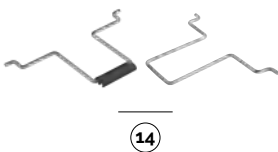

11 pluto-châssis 4 pieds tube d.18 sans embouts
pluto-estructura 4 patas tubular d. 18 sin tapones

code	finishing	q.kit	q.pack	a	b	c	kg.x1	vol.x1
110603-022	● noir/negro	x1	200	450	450	520	1,70	mc. 0,02
110604-022	● gris/gris ig2621	x1	200	450	450	520	1,70	mc. 0,02
110605-023	○ ivoire/marfil ral1013	x1	200	450	450	520	1,70	mc. 0,02
110610-135	● chromé/cromado	x1	200	450	450	520	1,70	mc. 0,02

12 pack embouts ronds d.18 noirs
paquete de tacos redondos d.18 negros

code	finishing	q.kit	q.pack
137003-072	● noir/negro	x4	200
134205-181	○ blanc/blanco	x4	

05 pluto-coque entière modèle pluto
pluto-carcasa completa modelo pluto

code	finishing	q.kit	q.pack	a	b	c	kg.x1	vol.x1
133907-065	● brun/marrón ral8022	x1	10	420	435	435	1,946	mc. 0,02

13 pluto-pack accessoires pour tube coque pluto
pluto-paquete de accesorios para carcasa pluto para tubular

code	finishing	q.kit	q.pack	kg.x1	vol.x1
137003-003	● brun/marrón ral8022	x1	10	châssis tube/estructura tubular	0,085 mc. 0,001

07 pluto-panneau assise à tapisser
pluto-panel asiento para tapizar

code	finishing	q.kit	q.pack	vol.x1
132203-047	● noir/negro	x1	20	mc. 0,003

08 pack vis tbl + fr 5x14 (pour panneau à revêtir)
paquete de tornillos tbl + fr 5x14 (para galleta tapizable)

code	finishing	q.kit	q.pack
117003-071	● noir/negro	x4	200

14 pluto-paire de grappins d'attelage latéral tige • plastique noir
pluto-pareja de enganches laterales de varilla + plástico negro

code	finishing	q.kit	q.pack
113410-004	● chromé/cromado	x1	50



for all colour codes, see page 305

pluto

stool

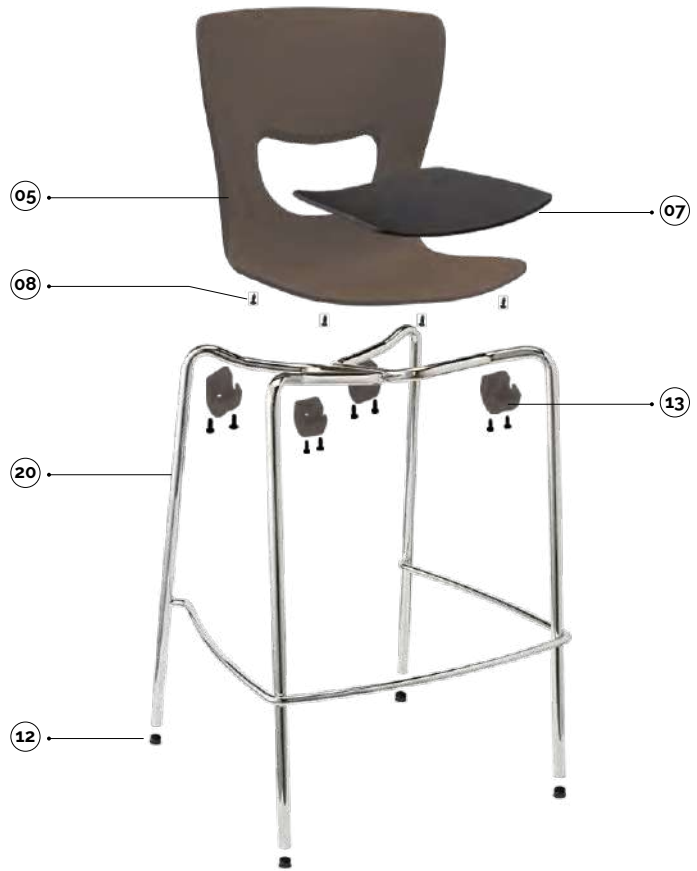

plastic colours

- rouge/rojo p1797u
- brun/marrón ral 8022
- gris/gris ral7003
- ivoire/marfil ral1013
- jaune/amarillo ral1012
- bleu/azul ral5014

main component sizes

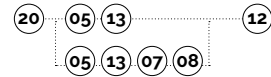
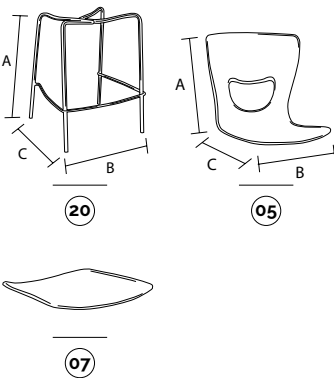

20 pluto-tabouret haut h630 pour coque sans embouts

pluto-taburete alto h630 tubular para carcasa sin tapones

code	finishing	q.kit	q.pack	a	b	c	kg.x1	vol.x1
110603-039	● noir/negro	x1	50	630	470	500	4,20	mc. 0,08
110604-039	● gris/gris ig2621	x1	50	630	470	500	4,20	mc. 0,08
110605-039	○ ivoire/marfil ral1013	x1	50	630	470	500	4,20	mc. 0,08
110610-039	● chromé/cromado	x1	50	630	470	500	4,20	mc. 0,08

12 pack embouts ronds d.18 noirs

paquete de tacos redondos d.18 negros

code	finishing	q.kit	q.pack
137003-072	● noir/negro	x4	200
134205-181	○ blanc/blanco	x4	

05 pluto-coque entière modèle pluto

pluto-carcasa completa modelo pluto

code	finishing	q.kit	q.pack	a	b	c	kg.x1	vol.x1
133907-065	● brun/marrón ral8022	x1	10	420	435	435	1,946	mc. 0,02

13 pluto-pack accessoires pour tube coque pluto

pluto-paquete de accesorios para carcasa pluto para tubular

code	finishing	q.kit	q.pack	kg.x1	vol.x1
137003-003	● brun/marrón ral8022	x1	10	châssis tube/estructura tubular	0,085 mc. 0,001

07 pluto-panneau assise à tapisser

pluto-panel asiento para tapizar

code	finishing	q.kit	q.pack	vol.x1
132203-047	● noir/negro	x1	20	mc. 0,003

08 pack vis tbl +fr 5x14 (pour panneau à revêtir)

paquete de tornillos tbl +fr 5x14 (para galleta tapizable)

code	finishing	q.kit	q.pack
117003-071	● noir/negro	x4	200



for all colour codes, see page 305

pluto

swivel



plastic colours

- rouge/rojo p1797u
- brun/marrón ral 8022
- gris/gris ral7003
- ivoire/marfil ral1013
- jaune/amarillo ral1012
- bleu/azul ral5014

main component sizes

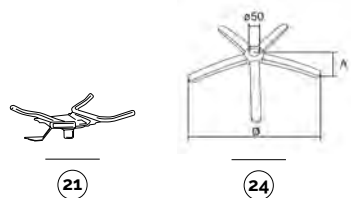

optionals

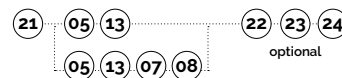
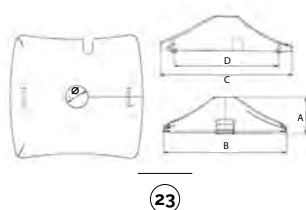

21 pluto-support pivotant au gaz pour coque pluto

pluto-soporte versión giratoria con mecanismo de gas para carcasa pluto

code	finishing	q.kit	q.pack	kg.x1	vol.x1
110903-012	● noir/negro	x1	10	1,40	mc. 0,004
110904-012	● gris/gris ig2621	x1	10	1,40	mc. 0,004

22 pack embouts couvre-tête d.18 noirs

paquete de tapones embellecedores d.18 negros

code	finishing	q.kit	q.pack
137003-070	● noir/negro	x4	200

23 cpg-couverture en plastique pour châssis pivotant

cpg-cubierta de plástico para estructura versión giratoria

code	finishing	q.kit	q.pack	a	b	c	d	ø	kg.x1	vol.x1
130903-000	● noir/negro	x1	50	60	200	210	167	36	0,1	mc. 0,0015

24 b40-base en métal avec cache-soudure

b40-base de metal con embellecedor soldadura

code	finishing	q.kit	q.pack	a	ø	kg.x1	vol.x1
110210-027	● chromé/cromado	x1	5	60	640	2,85	mc. 0,014

for the components below, see previous pages

05 13 07 08



for all colour codes, see page 305

CPG
plastic cover for swivel frame



pluto

bench



plastic colours

- rouge/rojo p1797u
- brun/marrón ral 8022
- gris/gris ral7003
- ivoire/marfil ral1013
- jaune/amarillo ral1012
- bleu/azul ral5014

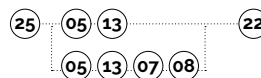

25 pluto-support pour raccordement coque pluto à banquette
pluto-soporte para enganche carcasa pluto en bancada

code	finishing	q.kit	q.pack	kg.x1	vol.x1
110703-188	● noir/negro	x1	10	1.40	mc. 0.004

22 pack embouts couvre-tête d.18 noirs
paquete de tapones embellecedores d.18 negros

code	finishing	q.kit	q.pack
137003-070	● noir/negro	x4	200



25

main component sizes

for the components below, see previous pages

05 13 07 08



for all colour codes, see page 305

for the bench components, see page 417

optionals

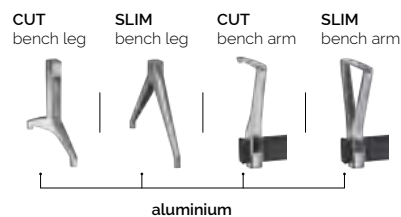



shell colour codes



05 coque entière en plastique carcasa completa de plástico

- 133902-065 rouge/rojo p1797u
- 133907-065 brun/marrón ral 8022
- 133904-065 gris/gris ral7003
- 133905-065 ivoire/marfil ral1013
- 133908-065 jaune/amarillo ral1012
- 133915-065 bleu/azul ral5014



13 accessoires pour tube coque en plastique accesorios para carcasa para tubular de plástico

- 137002-003 rouge/rojo p1797u
- 137003-003 brun/marrón ral 8022
- 137004-003 gris/gris ral7003
- 137005-003 ivoire/marfil ral1013
- 137008-003 jaune/amarillo ral1012
- 137015-003 bleu/azul ral5014

accessory colour codes



06 accessoires pour coque fil en plastique accesorios para carcasa para varilla de plástico

- 137002-004 rouge/rojo p1797u
- 137003-004 brun/marrón ral 8022
- 137004-004 gris/gris ral7003
- 137005-004 ivoire/marfil ral1013
- 137008-004 jaune/amarillo ral1012
- 137015-004 bleu/azul ral5014





teddy



discover more about
Teddy Collection

Une assise d'école respectant la réglementation.
Extrêmement robuste et confortable.
Teddy est une solution pratique et polyvalente, parfaite pour les écoles.
Elle est également proposée avec un châssis en traîneau renversé pour faciliter le nettoyage du milieu environnant.

Teddy a été conçue pour les écoles.

La silla para el mundo de la escuela, que cumple las normativas. Teddy, sumamente robusta y confortable, es una solución práctica y versátil, perfecta para la escuela. Disponible también con estructura de patin invertido para favorecer la limpieza del ambiente circundante

Teddy se ha creado para el ambiente escolar.

Plus

- 4 dimensions pour les châssis et 2 pour les coques.
- 4 couleurs sont proposées pour la coque modèle adapté à un environnement scolaire.
- 3 différentes finitions possibles pour les châssis.
- Une grande solidité et un confort absolu.
- Facile à soulever grâce au trou central situé sur la coque.
- Pratique à empiler.
- 4 tamaños para las estructuras y 2 para las carcasas.
- 4 colores disponibles para la carcasa y específicos para el ambiente de la escuela.
- 3 posibles acabados para las estructuras.
- Máxima robustez y confort absoluto.
- Fácil de levantar con el orificio central de la carcasa.
- Práctica de apilar.

teddy

slide

H. 460



plastic colours

- rouge/rojo ral3002
- jaune/amarillo ral1021
- bleu/azul ral517
- vert/verde ral6001

01 02 03 04 05 06 07 08 09

main component sizes

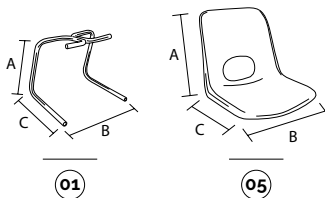

01 teddy-châssis coulissant d.25 asform sans embouts 6° niveau
teddy-estructura patin d. 25 asform sin taponés 6° nivel

code	finishing	q.kit	q.pack	a	b	c	kg.x1	vol.x1
110503-117	● noir/negro	x1	64	435	455	465	4.0	mc. 0.02
110504-117	● gris/gris ral2220	x1	64	435	455	465	4.0	mc. 0.02
110510-117	● chromé/cromado	x1	64	435	455	465	4.0	mc. 0.02

02 teddy-pied anticapotage en plastique noir
teddy-pie antivuelco de plástico negro

code	finishing	q.kit
134303-016	● noir/negro	x2

03 teddy-pied arrière en plastique noir
teddy-pie trasero de plástico negro

code	finishing	q.kit
134303-017	● noir/negro	x2

04 vis auto-taraudeuse ph tc*4,8x19 zinguée noire
tornillo autoperforante ph tc*4,8x19 galvanizado negro

code	finishing	q.kit
117803-165	● zinguée noir/galvanizado negro	x6

05 teddy-coque entière modèle teddy 5°-6° niveau
teddy-carcasa completa modelo teddy nivel 5°-6°

code	finishing	q.kit	q.pack	a	b	c	kg.x1	vol.x1
133915-067	● bleu/azul ral517	x1	10	375	380	350	0,946	mc. 0,018

06 pack vis hilo zinguée d.5x35 tête croix évasée
paquete de tornillos hi-lo d.5x35 cabeza avellanada en cruz galvanizados

code	finishing	q.kit	q.pack
117011-070	● zinguée/galvanizado	x4	200

07 pit-pare-chocs avec entaille
pit-topes con hueco

code	finishing	q.kit
134006-103	○ neutre/neutro	x4

08 vis auto-perceuse tc* 4,8x16 zinguée
tornillo autoperforante tc*4,8x16 galvanizado

code	finishing	q.kit
117811-152	● zinguée/galvanizado	x4

09 embout couvre-tête d.25 noir
tapón embellecedor d.25 negro

code	finishing	q.kit
134103-220	● noir/negro	x2
134104-220	● gris/gris	x2



for all colour codes, see page 313

teddy

4-legs

H. 350 3° LIVELLO
3° LEVEL



plastic colours

- rouge/rojo ral3002
- jaune/amarillo ral1021
- bleu/azul ral517
- vert/verde ral6001

10 11 12 06

main component sizes

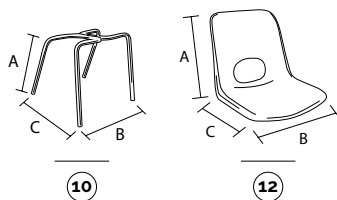

10 teddy-châssis 4 pieds d.22 sans embouts 3° niveau
teddy-estructura 4 patas d. 22 sin tapones 3° nivel

code	finishing	q.kit	q.pack	a	b	c	kg.x1	vol.x1
110103-050	● noir/negro	x1	80	325	380	390	1.80	mc. 0.02
110104-050	● gris/gris ral2220	x1	80	325	380	390	1.80	mc. 0.02
110110-050	● chromé/cromado	x1	80	325	380	390	1.80	mc. 0.02

11 embout d.22 tête sphérique
tapón d.22 cabeza esférica

code	finishing	q.kit
134203-224	● noir/negro	x4

12 teddy-coque entière modèle teddy 3°- 4° niveau
teddy-carcasa completa modelo teddy nivel 3°- 4°

code	finishing	q.kit	q.pack	a	b	c	kg.x1	vol.x1
133916-066	● vert/verde ral6001	x1	10	335	325	290	0.624	mc. 0.016

06 pack vis hilo zinguée d.5x35 tête croix évasée
paquete de tornillos hi-lo d.5x35 cabeza avellanada en cruz galvanizados

code	finishing	q.kit	q.pack
117011-070	● zinguée/galvanizado	x4	200



for all colour codes, see page 313

teddy

4-legs

H. 380 4° LIVELLO
4° LEVEL



plastic colours

- rouge/rojo ral3002
- jaune/amarillo ral1021
- bleu/azul ral517
- vert/verde ral6001

13 11 12 06

main component sizes

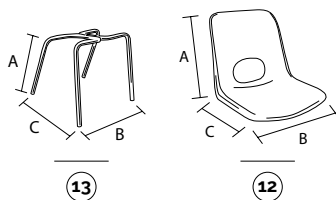

13 teddy-châssis 4 pieds d.22 sans embouts 4° niveau
teddy-estructura 4 patas d. 22 sin tapones 4° nivel

code	finishing	q.kit	q.pack	a	b	c	kg.x1	vol.x1
110103-051	● noir/negro	x1	80	350	380	410	2,0	mc. 0,02
110104-051	● gris/gris ral2220	x1	80	350	380	410	2,0	mc. 0,02
110110-051	● chromé/cromado	x1	80	350	380	410	2,0	mc. 0,02

11 embout d.22 tête sphérique
tapón d.22 cabeza esférica

code	finishing	q.kit
134203-224	● noir/negro	x4

12 teddy-coque entière modèle teddy 3°- 4° niveau
teddy-carcasa completa modelo teddy nivel 3°- 4°

code	finishing	q.kit	q.pack	a	b	c	kg.x1	vol.x1
133902-066	● rouge/rojo ral3002	x1	10	335	325	290	0,624	mc. 0,016

06 pack vis hilo zinguée d.5x35 tête croix évasée
paquete de tornillos hi-lo d.5x35 cabeza avellanada en cruz galvanizados

code	finishing	q.kit	q.pack
117011-070	● zinguée/galvanizado	x4	200



for all colour codes, see page 313

teddy

4-legs

H. 430 5° LIVELLO
5° LEVEL



14 11 05 06

plastic colours

- rouge/rojo ral3002
- jaune/amarillo ral1021
- bleu/azul ral517
- vert/verde ral6001

main component sizes

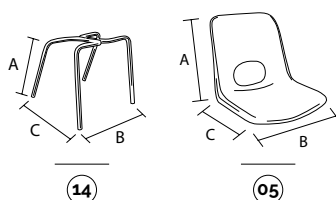

14 teddy-châssis 4 pieds d.22 sans embouts 5° niveau
teddy-estructura 4 patas d. 22 sin tapones 5° nivel

code	finishing	q.kit	q.pack	a	b	c	kg.x1	vol.x1
110103-052	● noir/negro	x1	80	405	435	485	2.20	mc. 0.02
110104-052	● gris/gris ral2220	x1	80	405	435	485	2.20	mc. 0.02
110110-052	● chromé/cromado	x1	80	405	435	485	2.20	mc. 0.02

11 embout d.22 tête sphérique
tapón d.22 cabeza esférica

code	finishing	q.kit
134203-224	● noir/negro	x4

05 teddy-coque entière modèle teddy 5°-6° niveau
teddy-carcasa completa modelo teddy nivel 5°-6°

code	finishing	q.kit	q.pack	a	b	c	kg.x1	vol.x1
133908-067	● jaune/amarillo ral1021	x1	10	375	380	350	0.946	mc. 0.018

06 pack vis hilo zinguée d.5x35 tête croix évasée
paquete de tornillos hi-lo d.5x35 cabeza avellanada en cruz galvanizados

code	finishing	q.kit	q.pack
117011-070	● zinguée/galvanizado	x4	200



for all colour codes, see page 313

teddy

4-legs

H. 460

6° LIVELLO
6° LEVEL



15 11 05 06

plastic colours

- rouge/rojo ral3002
- jaune/amarillo ral1021
- bleu/azul ral517
- vert/verde ral6001

main component sizes

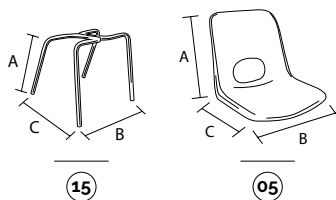

15 teddy-châssis 4 pieds d.22 sans embouts 6° niveau
teddy-estructura 4 patas d. 22 sin tapones 6° nivel

code	finishing	q.kit	q.pack	a	b	c	kg.x1	vol.x1
110103-053	● noir/negro	x1	80	430	435	505	2.40	mc. 0.02
110104-053	● gris/gris ral2220	x1	80	430	435	505	2.40	mc. 0.02
110110-053	● chromé/cromado	x1	80	430	435	505	2.40	mc. 0.02

11 embout d.22 tête sphérique
tapón d.22 cabeza esférica

code	finishing	q.kit
134203-224	● noir/negro	x4

05 teddy-coque entière modèle teddy 5°-6° niveau
teddy-carcasa completa modelo teddy nivel 5°-6°

code	finishing	q.kit	q.pack	a	b	c	kg.x1	vol.x1
133915-067	● bleu/azul ral517	x1	10	375	380	350	0.946	mc. 0.018

06 pack vis hilo zinguée d.5x35 tête croix évasée
paquete de tornillos hi-lo d.5x35 cabeza avellanada en cruz galvanizados

code	finishing	q.kit	q.pack
117011-070	● zinguée/galvanizado	x4	200



for all colour codes, see page 313

teddy

optional colour codes



shell colour codes



12 coque en plastique
carcasa de plástico



- 133902-066 rouge/rojo ral3002
- 133908-066 jaune/amarillo ral1021
- 133915-066 bleu/azul ral517
- 133916-066 vert/verde ral6001



05 coque en plastique
carcasa de plástico

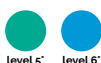

- 133902-067 rouge/rojo ral3002
- 133908-067 jaune/amarillo ral1021
- 133915-067 bleu/azul ral517
- 133916-067 vert/verde ral6001





pull



discover more about
Pull Collection

Cette assise est dotée d'un dessin moderne et séduisant et d'une monocoque en plastique proposée dans plusieurs couleurs.

Elle est parfaite pour différents environnements s'adressant au Public, où il est indispensable de pouvoir l'empiler et où elle doit être légère et simple à utiliser : elle est parfaite pour le secteur professionnel, les salles d'attentes, mais aussi pour le secteur formation.

En plus de la version 4 pieds et traîneau, cette assise est prévue pour la version tournante et pour les bancs.

Un asiento de diseño moderno y atractivo, con monocarcasa de plástico en varios colores.

Es ideal para los varios ambientes de la colectividad, donde se demanda apilabilidad, ligereza y sencillez de utilización: contract, zonas de espera y sector de formación.

Junto a las versiones de 4 patas y de patín, encontramos las versiones giratorias y la bancada.



**trolley
available**

pull

slide

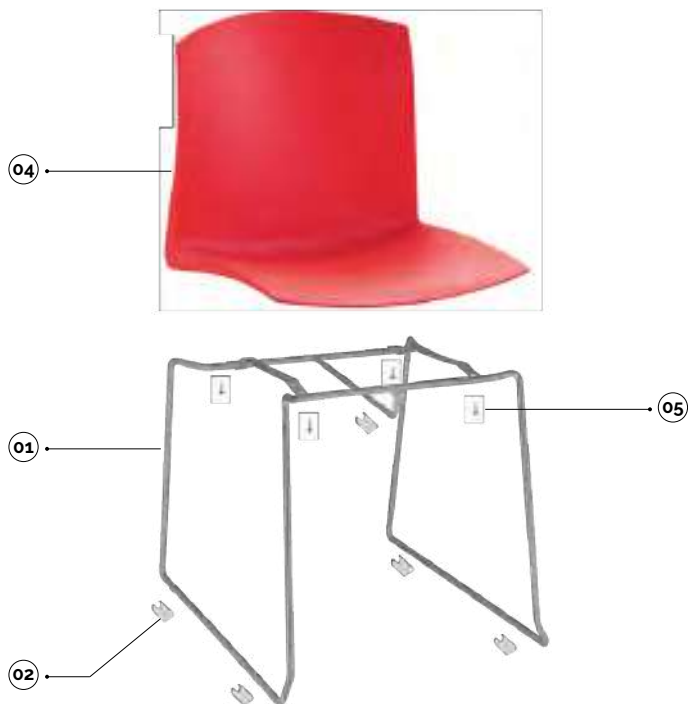

plastic colours

- gris/gris ral 7035
- noir/negro
- orange/naranja ral 2003
- blanc/blanco 218
- rouge/rojo 527

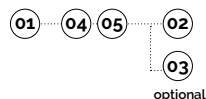

main component sizes

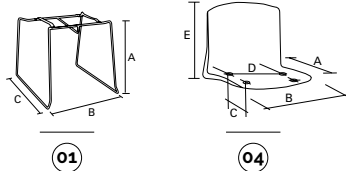

optionals

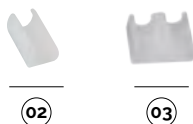

01 speedy-tabouret en tige pour coque modèle pull speedy-estructura de varilla para carcasa modelo pull

code	finishing	q.kit	q.pack	a	b	c	kg.x1	vol.x1
113410-025	● chromé/cromado	x1	120	450	490	570	3,05	mc. 0,04

02 pack de bases à pince anti-rotation pour tige couleur neutre paquete de bases con pinza antirotación para varilla de color neutro

code	finishing	q.kit	q.pack
137006-070	○ neutre/neutro	x4	200

03 base plate à pince double en pe pour élément de jonction chaises base plana con pinza doble de pe para varilla para unión sillas

code	finishing	q.kit
134006-021	○ neutre/neutro	x4

04 pull-coque entière modèle pull pull-carcasa completa modelo pull

code	finishing	q.kit	q.pack	a	b	c	d	e	kg.x1	vol.x1
133902-026	● rouge/rojo 527	x1	10	520	450	255	315	393	1,60	mc. 0,021

05 vis tc+combi 6x16 tête cylindrique croix zinguée (vis fixation coque) tornillo tc+combi 6x16 cabeza cilíndrica en cruz galvanizado (tornillo fijación carcasa)

code	finishing	q.kit
117811-181	○ zinguée/galvanizado	x4

speedy-chariot porte-chaises avec accessoires speedy-trolley for chairs with accessories black

code	finishing
110803-358	● noir/negro



for all colour codes, see page 319

pull

4-legs



plastic colours

- gris/gris ral 7035
- noir/negro
- orange/naranja ral 2003
- blanc/blanco 218
- rouge/rojo 527

main component sizes

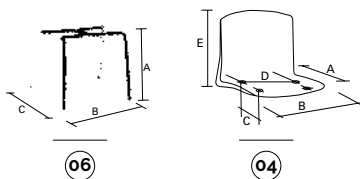

optionals

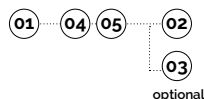

06 pull-tabouret 4 pieds tube d.18 pull-taburete 4 patas tubular d.18

code	finishing	q.kit	q.pack	a	b	c	kg.x1	vol.x1
110603-075	● noir/negro	x1	200	450	470	490	2,00	mc. 0,02
110604-095	● gris/gris	x1	200	450	470	490	2,00	mc. 0,02
110610-045	● chromé/cromado	x1	200	450	470	490	2,00	mc. 0,02

07 pack embouts ronds ø18 noirs paquete de tacos redondos d.18 negros

code	finishing	q.kit	q.pack
137003-072	● noir/negro	x4	200

08 pack vis hilo 5,5x30 tête évasée croix zinguée (vis pour fixation coque) paquete de tornillos hi-lo 5,5x30 cabeza avellanada en cruz galvanizados (tornillo para fijación carcasa)

code	finishing	q.kit	q.pack
117011-071	○ zinguée/galvanizado	x4	200

04 pull-coque entière modèle pull pull-carcasa completa modelo pull

code	finishing	q.kit	q.pack	a	b	c	d	e	kg.x1	vol.x1
133903-025	● noir/negro	x1	10	520	450	255	315	393	1,60	mc. 0,021

09 support pour empiler les coques neutres soporte para apilabilidad carcasa neutro

code	finishing	q.kit	kg.x1
134006-030	○ neutre/neutro	x1	0,025

10 vis hilo tb 5x14 noire tornillo hi-lo tb 5x14 negro

code	finishing	q.kit
117803-155	● noir/negro	x1

pull-chariot porte-chaises avec accessoires pull-carro para sillas con accesorios

code	finishing
110803-347	● noir/negro



for all colour codes, see page 319

pull

swivel



plastic colours

- gris/gris ral 7035
- noir/negro
- orange/naranja ral 2003
- blanc/blanco 218
- rouge/rojo 527

main component sizes

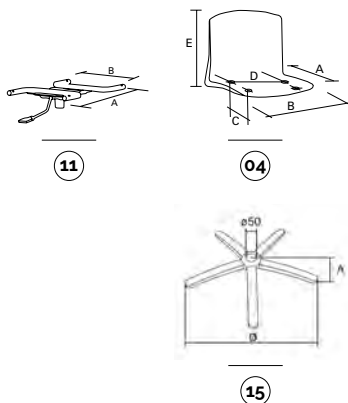

optionals

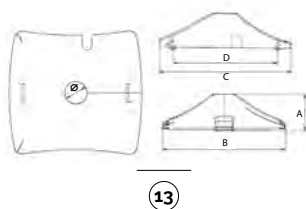

11 04 08 12 13 15
optional

11 support pivotant au gaz pour coque pull
soporte versión giratoria con mecanismo de gas para carcasa pull

code	finishing	q.kit	q.pack	a	b	kg.x1	vol.x1
110903-025	● noir/negro	x1	10	315	255	1.40	mc. 0.004

12 pack embouts couvre-tête ø18
paquete de tapones d.18

code	finishing	q.kit	q.pack
137003-070	● noir/negro	x4	200

04 pull-coque entière modèle pull
pull-carcasa completa modelo pull

code	finishing	q.kit	q.pack	a	b	c	d	e	kg.x1	vol.x1
133907-025	● orange/naranja ral 2003	x1	10	520	450	255	315	393	1.60	mc. 0.021

08 pack vis hilo 5,5x30 tête évasée croix zinguée (vis pour fixation coque)
paquete de tornillos hi-lo 5,5x30 cabeza avellanada en cruz galvanizados (tornillo para fijación carcasa)

code	finishing	q.kit	q.pack
117011-071	○ zinguée/galvanizado	x4	200

13 cpg-couverture en plastique pour châssis pivotant
cpg-cubierta de plástico para estructura versión giratoria

code	finishing	q.kit	q.pack	a	b	c	d	ø	kg.x1	vol.x1
130903-000	● noir/negro	x1	50	60	200	210	167	36	0.1	mc. 0.0015

15 b40-base en métal avec cache-soudure
b40-base de metal con embellecedor soldadura

code	finishing	q.kit	q.pack	a	ø	kg.x1	vol.x1
110210-027	● chromé/cromado	x1	5	60	640	2.85	mc. 0.014

CPG
plastic cover for swivel frame

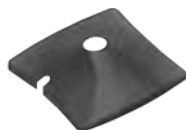

➔ for all colour codes, see page 319

pull

bench



plastic colours

- gris/gris ral 7035
- noir/negro
- orange/naranja ral 2003
- blanc/blanco 218
- rouge/rojo 527

14 04 08 12

14 support pour raccordement coque pull sur banquette soporte para enganche carcasa pull en bancada

code	finishing	q.kit	q.pack	a	b	kg.x1	vol.x1
110703-085	● noir/negro	x1	10	315	255	1.40	mc. 0.004

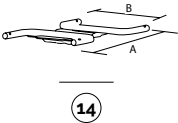

for the components below, see previous pages

for all colour codes, see below

12 04 08

main component sizes

for the bench components, see page 417

optionals

OPTIONAL
bench
connector



E-USB
bench plug



JIM
bench leg



plastic

90GM
bench leg



90GF
bench leg



91GM **NEW**
bench leg



100GM
bench leg



200GM
bench leg



PIONEER
bench arm



metal

CUT
bench leg



SLIM
bench leg



CUT
bench arm



SLIM
bench arm



aluminium

pull

optional colour codes



shell colour codes

04 coque en plastique
carcasa de plástico

- 133904-026 gris/gris ral 7035
- 133903-025 noir/negro
- 133907-025 orange/naranja ral 2003
- 133905-026 blanc/blanco 218
- 133902-026 rouge/rojo 527





q5



discover more about
Q5 Collection

Une assise se caractérisant par une ligne élégante et des détails particuliers. Elle représente l'expression parfaite du design italien.

Sa coque, disponible dans 4 couleurs modernes peut être associée à une série complète de châssis et d'accessoires qui font de Q5 la solution idéale pour plusieurs environnements : de la maison au secteur professionnel, jusqu'aux salles de formation, car elle est facilement empilable.

Un asiento caracterizado por una línea elegante y por detalles distintivos: la perfecta expresión del diseño italiano.

La carcasa en 4 colores modernos se combina con una serie completa de estructuras y accesorios, que convierten Q5 en la solución ideal para ambientes diferentes: casa, contract o zonas de formación, también porque es cómodamente apilable.

Plus

- Certification ANSI/BIFMA X5.1 (pour la version à 4 pieds, la certification n'est disponible qu'avec un châssis spécial de 2 mm d'épaisseur).
- *Certificación ANSI/BIFMA X5.1 (para la versión de 4 patas, la certificación sólo está disponible con una estructura especial de 2 mm de grosor).*



**certified
product**

q5

slide

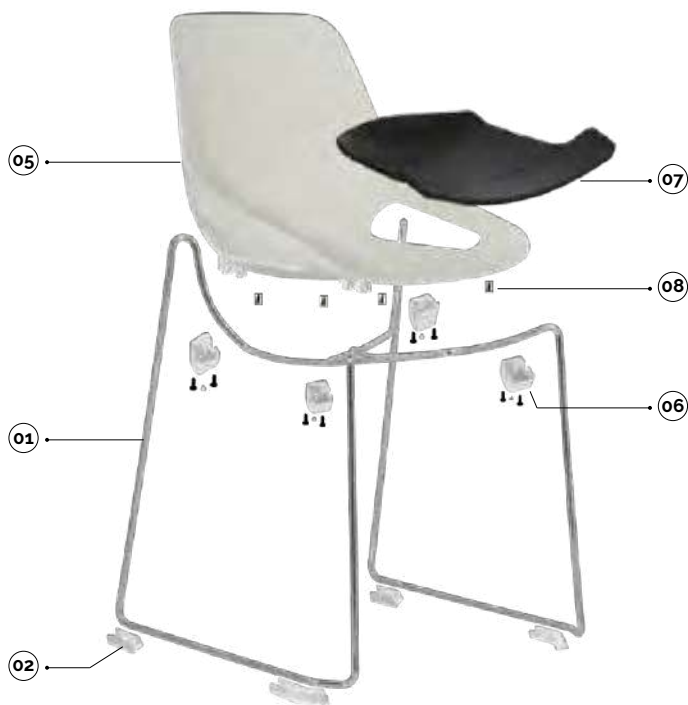

plastic colours

- brun/marrón ral8022
- ivoire/marfil ral1013
- jaune/amarillo ral1012
- gris/gris ral7003

main component sizes

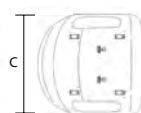
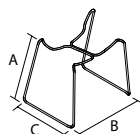
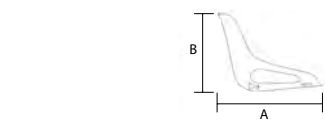

01

05

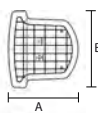

07

optionals



02



03



04

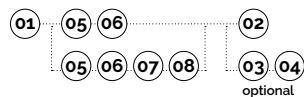

01 q5-châssis coulissant tige pour coque sans embouts

q5-estructura patin de varilla para carcasa sin tapones

code	finishing	q.kit	q.pack	a	b	c	kg.x1	vol.x1
113410-012	● chromé/cromado	x1	100	450	550	510	4,00	mc. 0.04

02 btf-kit pieds

btf-kit pies

code	finishing	q.kit	q.pack	kg.x1
134306-001	○ neutre/neutro	x1	100	0,05

03 btfa-kit pieds avec crochets

btfa-kit pies con ganchos

code	finishing	q.kit	q.pack	kg.x1
134306-002	○ neutre/neutro	x1	100	0,06

04 pptf-embout pour fixation au sol

pptf-tapón para fijación en el pavimento

code	finishing	q.kit	q.pack	kg.x1
134306-003	○ neutre/neutro	x2	100	0,03

05 q5-coque entière modèle q5

q5-carcasa completa modelo q5

code	finishing	q.kit	q.pack	a	b	c	kg.x1	vol.x1
133905-035	○ ivoire/marfil ral1013	x1	10	400	400	470	1,60	mc. 0.02

06 q5-pack accessoires pour coque q5

q5-paquete de accesorios para carcasa q5

code	finishing	q.kit	q.pack	kg.x1	vol.x1
137005-004	○ ivoire/marfil ral1013	x1	10	telaio in tondino/wire frame	0,085 mc. 0.00

07 q5-panneau assise à revêtir

q5-galleta asiento tapizable

code	finishing	q.kit	q.pack	a	b	kg.x1	vol.x1
132203-048	● noir/negro	x1	20	390	420	0,52	mc. 0.003

08 pack vis tbl+ fr. 05x14 pour panneau à revêtir

paquete de tornillos tbl+ fr. d.5x14 para galleta tapizable

code	finishing	q.kit	q.pack
117003-071	● noir/negro	x4	200



for all colour codes, see page 327

q5 stool

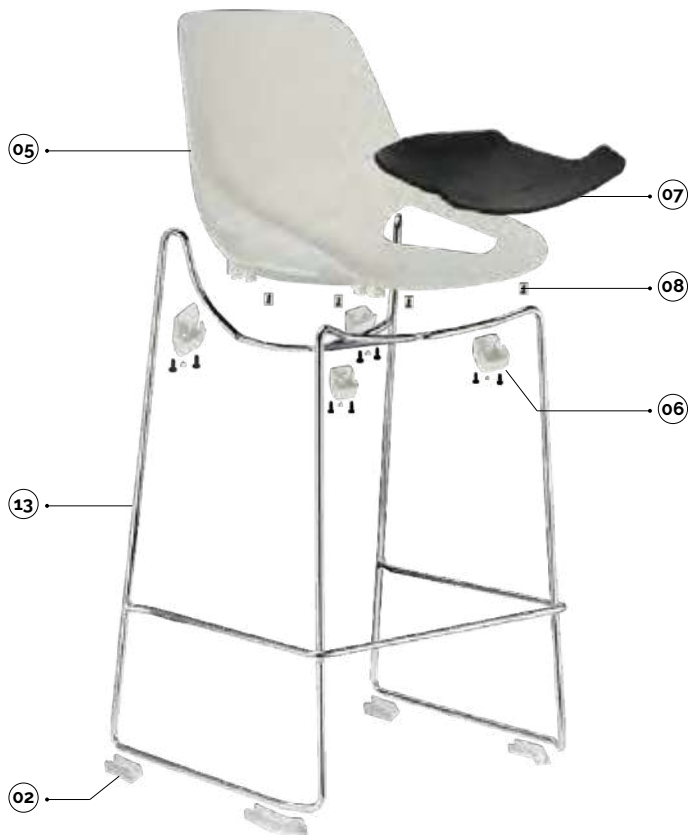

plastic colours

- brun/marrón ral8022
- ivoire/marfil ral1013
- jaune/amarillo ral1012
- gris/gris ral7003

main component sizes

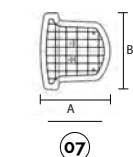
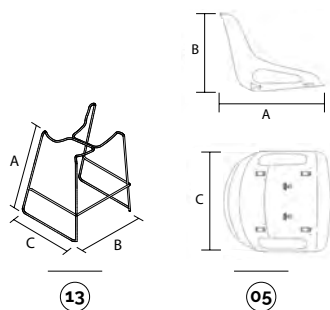

optionals

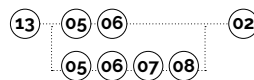

13 q5-tabouret haut en tige pour coque sans embouts q5-taburete alto de varilla para carcasa sin tapones

code	finishing	q.kit	q.pack	a	b	c	kg.x1	vol.x1
113410-006	● chromé/cromado	x1	50	700	550	510	6,30	mc. 0,08

02 btf-kit pieds btf-kit pies

code	finishing	q.kit	q.pack	kg.x1
134306-001	○ neutre/neutro	x1	100	0,05

05 q5-coque entière modèle q5 q5-carcasa completa modelo q5

code	finishing	q.kit	q.pack	a	b	c	kg.x1	vol.x1
133905-035	○ ivoire/marfil ral1013	x1	10	400	400	470	1,60	mc. 0,02

06 q5-pack accessoires pour coque q5 q5-paquete de accesorios para carcasa q5

code	finishing	q.kit	q.pack	kg.x1	vol.x1
137005-004	○ ivoire/marfil ral1013	x1	10	telaio in tondino/wire frame	0,085 mc. 0,00

07 q5-panneau assise à revêtir q5-galleta asiento tapizable

code	finishing	q.kit	q.pack	a	b	kg.x1	vol.x1
132203-048	● noir/negro	x1	20	390	420	0,52	mc. 0,003

08 pack vis tbl+ fr. 05x14 pour panneau à revêtir paquete de tornillos tbl+ fr. d.5x14 para galleta tapizable

code	finishing	q.kit	q.pack
117003-071	● noir/negro	x4	200



for all colour codes, see page 327

q5

4-legs



CERTIFIED BY
BIFMA



plastic colours

- brun/marrón ral8022
- ivoire/marfil ral1013
- jaune/amarillo ral1012
- gris/gris ral7003

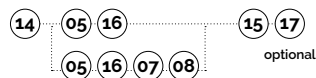

main component sizes

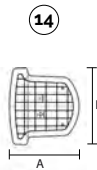
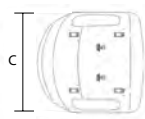
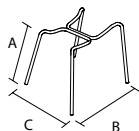
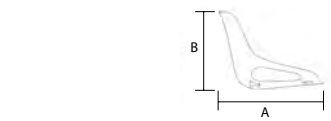

optionals

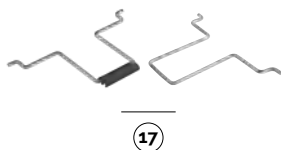

14 q5-châssis 4 pieds tube ø18 sans embouts

q5-estructura 4 patas tubular d. 18 sin tapones

code	finishing	q.kit	q.pack	a	b	c	kg.x1	vol.x1
110603-022	● noir/negro	x1	200	450	460	480	1,70	mc. 0,02
110604-022	● gris/gris	x1	200	450	460	480	1,70	mc. 0,02
110610-135	● chromé/cromado	x1	200	450	460	480	1,70	mc. 0,02

15 pack embouts ronds ø18 noirs

paquete de tacos redondos d.18 negros

code	finishing	q.kit	q.pack
137003-072	● noir/negro	x4	200

05 q5-coque entière modèle q5

q5-carcasa completa modelo q5

code	finishing	q.kit	q.pack	a	b	c	kg.x1	vol.x1
133903-035	● brun/marrón ral8022	x1	10	400	400	470	1,60	mc. 0,02

16 q5-pack accessoires pour coque q5

q5-paquete de accesorios para carcasa q5

code	finishing	q.kit	q.pack	kg.x1	vol.x1
137003-003	● brun/marrón ral8022	x1	10	telaio tubo/tube frame	0,085 mc. 0,00

07 q5-panneau assise à revêtir

q5-galleta asiento tapizable

code	finishing	q.kit	q.pack	a	b	kg.x1	vol.x1
132203-048	● noir/negro	x1	20	390	420	0,52	mc. 0,003

08 pack vis tbl+ fr. ø5x14 pour panneau à revêtir

paquete de tornillos tbl+ fr. d.5x14 para galleta tapizable

code	finishing	q.kit	q.pack
117003-071	● noir/negro	x4	200

17 q5-paire de grappins d'attelage latéral tige + plastique noir

q5-pareja de enganches laterales de varilla + plástico negro

code	finishing	q.kit	q.pack	kg.x1	vol.x1
113410-004	● chromé/cromado	x1	50	0,15	mc. 0,0004



for all colour codes, see page 327

q5 swivel



plastic colours

- brun/marrón ral8022
- ivoire/marfil ral1013
- jaune/amarillo ral1012
- gris/gris ral7003

main component sizes

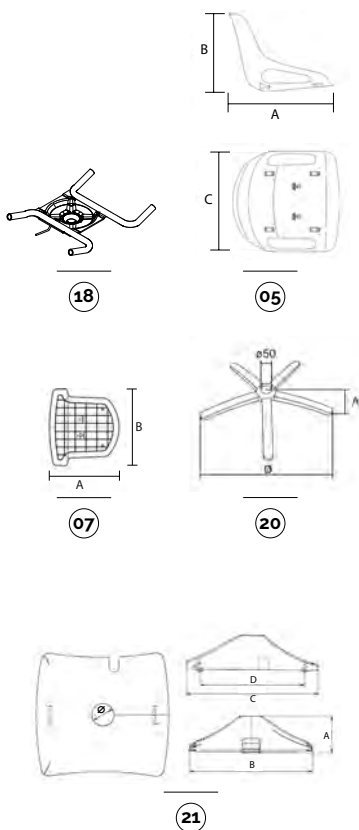

optionals

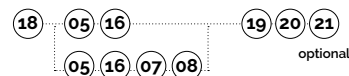

18 q5-support pivotant au gaz pour coque q5

q5-soporte versión giratoria con mecanismo de gas para carcasa q5

code	finishing	q.kit	q.pack	kg.x1	vol.x1
110903-012	● noir/negro	x1	10	1,50	mc. 0,004
110904-012	● gris/gris	x1	10	1,50	mc. 0,004

19 pack embouts couvre-tête noir ø18

paquete de tapones embellecedores negro d.18

code	finishing	q.kit	q.pack
137003-070	● noir/negro	x4	200

05 q5-coque entière modèle q5

q5-carcasa completa modelo q5

code	finishing	q.kit	q.pack	a	b	c	kg.x1	vol.x1
133905-035	○ ivoire/marfil ral1013	x1	10	400	400	470	1,60	mc. 0,02

16 q5-pack accessoires pour coque q5

q5-paquete de accesorios para carcasa q5

code	finishing	q.kit	q.pack	kg.x1	vol.x1
137005-003	○ ivoire/marfil ral1013	x1	10	telaio tubo/tube frame	0,085 mc. 0,00

07 q5-panneau assise à revêtir

q5-galleta asiento tapizable

code	finishing	q.kit	q.pack	a	b	kg.x1	vol.x1
132203-048	● noir/negro	x1	20	390	420	0,52	mc. 0,003

08 pack vis tbl+ fr. ø5x14 pour panneau à revêtir

paquete de tornillos tbl+ fr. d.5x14 para galleta tapizable

code	finishing	q.kit	q.pack
117003-071	● noir/negro	x4	200

20 b40-base en métal avec cache-soudure

b40-base de metal con embellecedor soldadura

code	finishing	q.kit	q.pack	a	ø	kg.x1	vol.x1
110210-027	● chromé/cromado	x1	5	60	640	2,85	mc. 0,014

21 cpq-couverture en plastique pour châssis pivotant

cpq-cubierta de plástico para estructura versión giratoria

code	finishing	q.kit	q.pack	a	b	c	d	ø	kg.x1	vol.x1
130903-000	● noir/negro	x1	50	60	200	210	167	36	0,1	mc. 0,0015

CPG
plastic cover for swivel frame

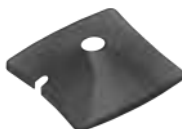

for all colour codes, see page 327

q5 bench



CERTIFIED BY
BIFMA

plastic colours

- brun/marrón ral8022
- ivoire/marfil ral1013
- jaune/amarillo ral1012
- gris/gris ral7003

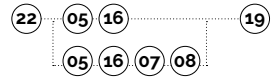

22 q5-support pour raccordement coque q5 sur banquette
q5-soporte para enganche carcasa q5 en bancada

code	finishing	q.kit	q.pack	kg.x1	vol.x1
110703-188	● noir/negro	x1	10	1.40	mc. 0.004

main component sizes

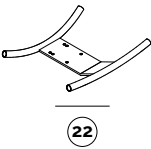

for the components below, see previous pages

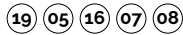

for all colour codes, see page 327

for the bench components, see page 417

optionals

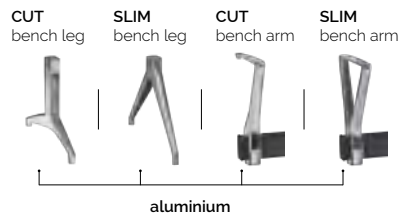
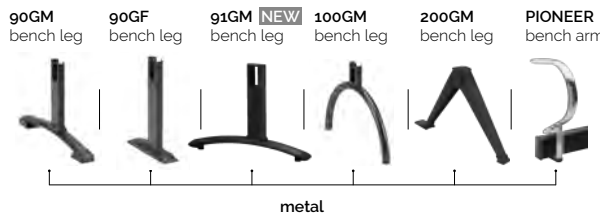
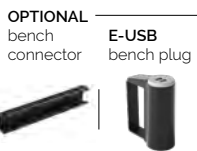

q5

optional colour codes



shell colour codes



05 coque en plastique carcasa de plástico

- 133903-035 brun/marrón ral8022
- 133905-035 ivoire/marfil ral1013
- 133908-035 jaune/amarillo ral1012
- 133904-035 gris/gris ral7003

accessory colour codes



06 accessoires pour coque - châssis coulissant accesorios para carcasa - estructura patin de varilla

- 137003-004 brun/marrón ral8022
- 137005-004 ivoire/marfil ral1013
- 137008-004 jaune/amarillo ral1012
- 137004-004 gris/gris ral7003



16 accessoires pour coque - châssis tube accesorios para carcasa - estructura tubular

- 137003-003 brun/marrón ral8022
- 137005-003 ivoire/marfil ral1013
- 137008-003 jaune/amarillo ral1012
- 137004-003 gris/gris ral7003



oki



discover more about
Oki Collection

Chaise possédant une large monocoque en plastique confortable, avec ses couleurs vives et son tron central au milieu, ce qui lui confère un look décontracté et pratique. Ce modèle est par ailleurs empilable et facile à nettoyer.

Grâce à la large gamme de châssis qui est proposée, cette chaise est disponible dans différentes finitions. Elle s'adapte à différents environnements, de la maison au bureau, jusqu'aux salles de réunion grâce à son châssis en tube avec accrochage latéral ainsi qu'aux accoudoirs et au porte-tablette.

Una silla con una monocarcasa de plástico, amplia, confortable y de colores vivos que, con el amplio orificio central, le regalan un look casual y práctico. Además, es apilable y fácil de limpiar.

Con la gama vasta de estructuras en varios acabados, se adapta a diferentes empleos en la casa, la oficina e incluso en las áreas de colectividad gracias a su estructura tubular con enganche lateral, los apoyabrazos y/o la pala.

oki

4-legs



plastic colours

- noir/negro
- blanc/blanco 218
- bleu/azul 5002

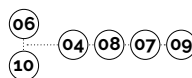

main component sizes

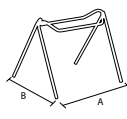

06

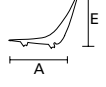
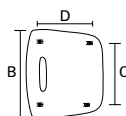

07

optionals

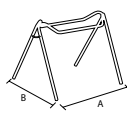

10

06 oki-tabouret 4 pied tube d.18 sans embouts

oki-taburete 4 patas tubular d.18 sin tapones

code	finishing	q.kit	q.pack	a	b	kg.x1	vol.x1
112703-090	● noir/negro	x1	100	560	520	2,70	mc. 0,02
112704-090	● gris/gris	x1	100	560	520	2,70	mc. 0,02
112710-090	● chromé/cromado	x1	100	560	520	2,70	mc. 0,02

07 embout tête sphérique ø18 noir

tapones cabeza esférica d.18 negro

code	finishing	q.kit
134203-181	● noir/negro	x4

08 vis auto-perceuse 5,5x35 tête cylindrique croix zinguée (vis fixation coque)

tornillo autoroscante 5,5x35 cabeza cilíndrica en cruz galvanizado (tornillo fijación carcasa)

code	finishing	q.kit	q.pack
117011-070	○ zinguée/galvanizado	x4	200

04 oki-coque entière modèle oki

oki-carcasa completa modelo oki

code	finishing	q.kit	q.pack	a	b	c	d	e	kg.x1	vol.x1
133905-050	○ blanc/blanco 218	x1	10	525	530	209	306	395	1,80	mc. 0,025

09 support pour empiler les coques neutres

soporte para apilabilidad carcasa neutro

code	finishing	q.kit
134006-031	○ neutre/neutro	x1

10 oki-tabouret 4 pieds en tube ø18 avec attelage latéral sans embouts

oki-taburete 4 patas tubular d.18 con enganche lateral sin tapones

code	finishing	q.kit	q.pack	a	b	kg.x1	vol.x1
112703-091	● noir/negro	x1	100	560	520	2,70	mc. 0,02
112704-091	● gris/gris	x1	100	560	520	2,70	mc. 0,02
112710-091	● chromé/cromado	x1	100	560	520	2,70	mc. 0,02

frame optional
4 legs stool d.18 tube with
lateral hooks

10



for all colour codes, see page 333

oki

swivel



plastic colours

- noir/negro
- blanc/blanco 218
- bleu/azul 5002

main component sizes

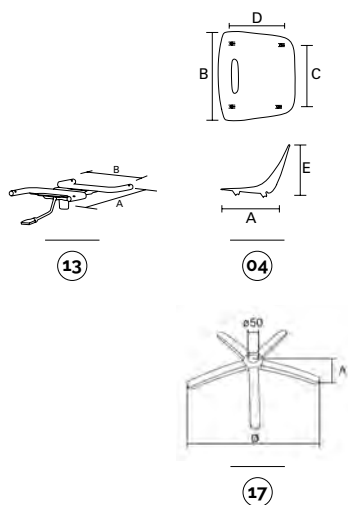

optionals

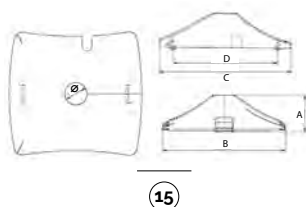

13 04 08 14 15 17
optional

13 oki-support pivotant au gaz pour coque oki
oki-soporte versión giratoria con mecanismo de gas para carcasa oki

code	finishing	q.kit	q.pack	a	b	kg.x1	vol.x1
110903-010	● noir/negro	x1	10	306	209	1,30	mc. 0.04

14 pack embouts couvre-tête ø18 noir
paquete de tapones embellecedores d.18 negro

code	finishing	q.kit	q.pack
137003-070	● noir/negro	x4	200

04 oki-coque entière modèle oki
oki-carcasa completa modelo oki

code	finishing	q.kit	q.pack	a	b	c	d	e	kg.x1	vol.x1
133915-050	● bleu/azul 5002	x1	10	525	530	209	306	395	1,80	mc. 0.025

08 vis auto-perceuse 5,5x35 tête cylindrique crois zinguée (vis fixation coque)
tornillo autoroscante 5,5x35 cabeza cilíndrica en cruz galvanizado (tornillo fijación carcasa)

code	finishing	q.kit	q.pack
117011-070	○ zinguée/galvanizado	x4	200

15 cpg-couverture en plastique pour châssis pivotant
cpg-cubierta de plástico para estructura versión giratoria

code	finishing	q.kit	q.pack	a	b	c	d	ø	kg.x1	vol.x1
130903-000	● noir/negro	x1	50	60	200	210	167	36	0,1	mc. 0.0015

17 b40-base en métal avec cache-soudure
b40-base de metal con embellecedor soldadura

code	finishing	q.kit	q.pack	a	ø	kg.x1	vol.x1
110210-027	● chromé/cromado	x1	5	60	640	2,85	mc. 0.014

CPG
plastic cover for swivel frame



➔ for all colour codes, see page 333

oki

bench



plastic colours

- noir/negro
- blanc/blanco 218
- bleu/azul 5002

16 04 08 14

16 oki-support pour raccordement coque oki sur banquette
 oki-soporte para enganche carcasa oki en bancada

code	finishing	q.kit	q.pack	a	b	kg.x1	vol.x1
110703-053	● noir/negro	x1	15	306	209	1.40	mc. 0.004

main component sizes

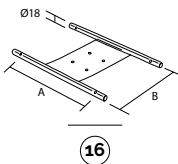

for the components below, see previous pages

04 08 14



for all colour codes, see page 333

for the bench components, see page 417

optionals

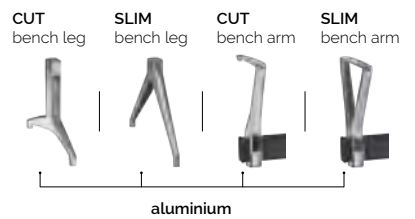
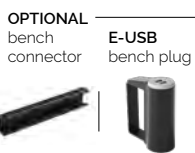



shell colour codes



04 coque en plastique
carcasa de plástico

- 133903-050 noir/negro
- 133905-050 blanc/blanco 218
- 133915-050 bleu/azul 5002





race



discover more about
Race Collection

Une monocoque au design géométrique et moderne, proposée dans 8 couleurs vives ; le panneau à tapisser peut être en option.

La large gamme de châssis proposée, allant du tabouret au banc, sont disponibles avec différentes finitions. Cela permet à ce modèle de s'adapter dans n'importe quel contexte, en particulier dans un environnement professionnel ou public car il est facilement empilable.

Una monocarcasa con un diseño geométrico y moderno, disponible en 8 colores vivos; en opción el panel tapizable.

La oferta vasta de estructuras, que comprende desde el taburete hasta la bancada, y en varios acabados, la convierten en un elemento que se adapta a todos los marcos, sobre todo, en los ambientes contract y colectividad también por la cómoda apilabilidad.



**trolley
available**

race

slide

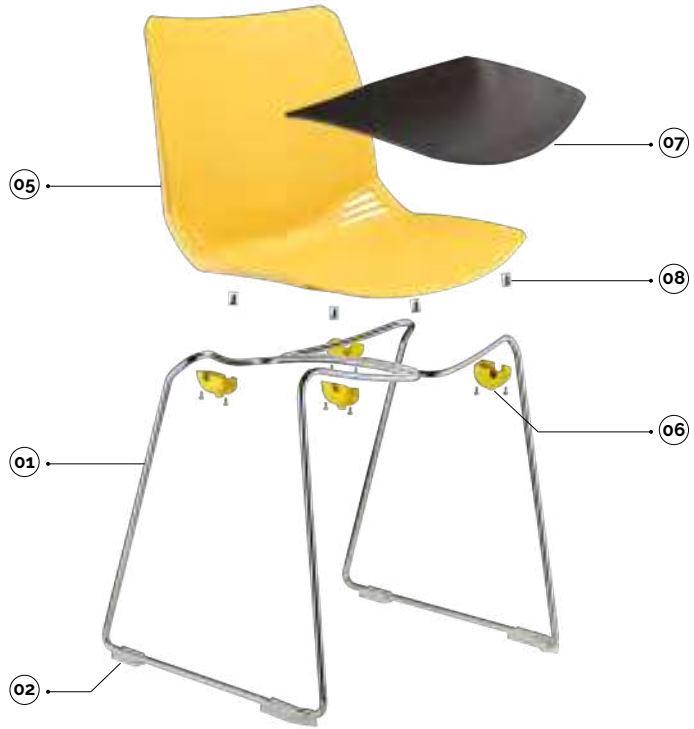

plastic colours

- bleu/azul ral5002
- orange/naranja ral2009
- violet/morado 145
- vert/verde 736
- ivoire/marfil ral1013
- gris/gris ral7003
- jaune/amarillo ral1012
- brun/marrón ral8022

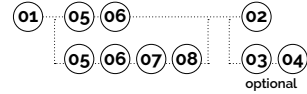

main component sizes

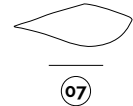
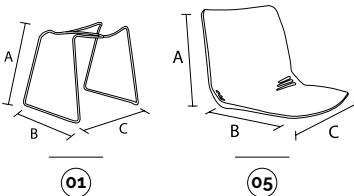

optionals

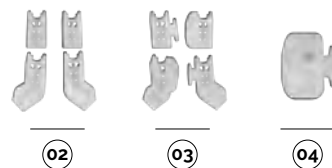

01 race-châssis coulissant tige pour coque sans embouts

race-estructura patin de varilla para carcasa sin tapones

code	finishing	q.kit	q.pack	a	b	c	kg.x1	vol.x1
113410-065	● chromé/cromado	x1	100	460	500	470	3,20	mc. 0.026

02 btf-kit pieds

btf-kit pies

code	finishing	q.kit	q.pack	kg.x1
134306-001	○ neutre/neutro	x1	100	0,05

03 btfa-kit pieds avec crochets

btfa-kit pies con ganchos

code	finishing	q.kit	q.pack	kg.x1
134306-002	○ neutre/neutro	x1	100	0,06

04 pptf-embout pour fixation au sol

pptf-tapón para fijación en el pavimento

code	finishing	q.kit	q.pack	kg.x1
134306-003	○ neutre/neutro	x2	100	0,03

05 race-coque entière modèle race

race-carcasa completa modelo race

code	finishing	q.kit	q.pack	a	b	c	kg.x1	vol.x1
133908-012	● jaune/amarillo ral1012	x1	10	380	410	450	1,60	mc. 0.02

06 race-pack accessoires pour coque race

race-paquete de accesorios para carcasa race

code	finishing	q.kit	q.pack	kg.x1	vol.x1
137008-006	● jaune/amarillo ral1012	x1	10	telaio in tondino/wire frame	0,085 mc. 0.001

07 race-panneau assise à revêtir

race-galleta asiento tapizable

code	finishing	q.kit	q.pack	kg.x1	vol.x1
132203-049	● noir/negro	x1	20	0,53	mc. 0.003

08 pack vis tbl+ fr. d.5x14 pour panneau à revêtir

paquete de tornillos tbl+ fr. d.5x14 para galleta tapizable

code	finishing	q.kit	q.pack	kg.x1	vol.x1
117003-071	● noir/negro	x4	200		

race-chariot porte-chaises noir avec accessoires

race-carro para sillas negro con accesorios

code	finishing	q.kit
110803-348	● noir/negro	x1



for all colour codes, see page 341



race

stool

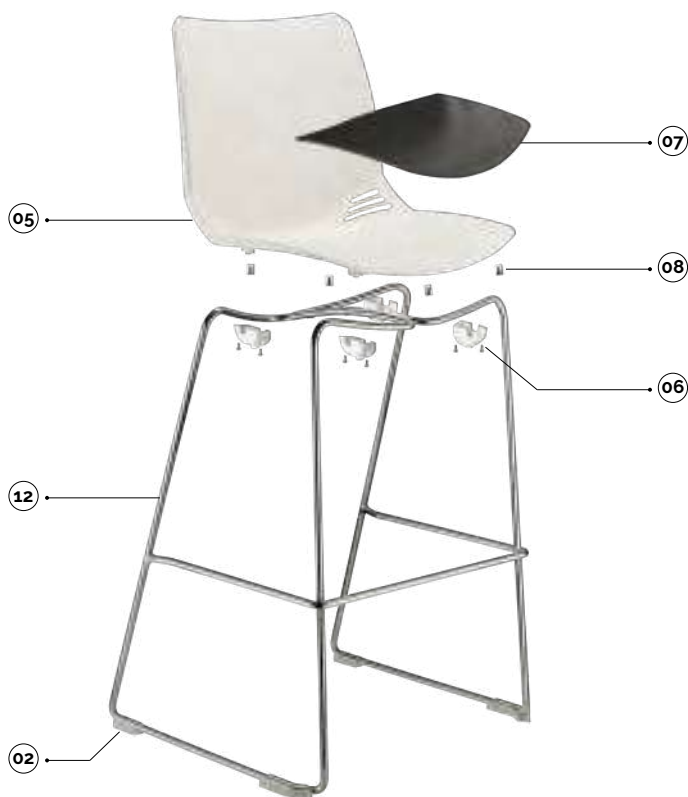

plastic colours

- bleu/azul ral5002
- orange/naranja ral2009
- violet/morado 145
- vert/verde 736
- ivoire/marfil ral1013
- gris/gris ral7003
- jaune/amarillo ral1012
- brun/marrón ral8022

main component sizes

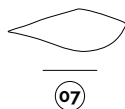
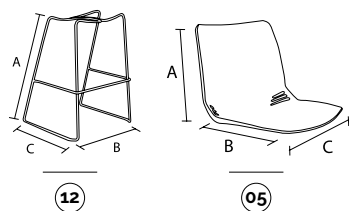

optionals

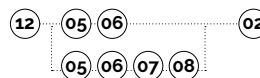

12 race-tabouret haut en tige pour coque sans embouts

race-taburete alto de varilla para carcasa sin tapones

code	finishing	q.kit	q.pack	a	b	c	kg.x1	vol.x1
113410-066	● chromé/cromado	x1	50	700	500	550	5,85	mc. 0.08

02 btf-kit pieds

btf-kit pies

code	finishing	q.kit	q.pack	kg.x1
134306-001	○ neutre/neutro	x1	100	0,05

05 race-coque entière modèle race

race-carcasa completa modelo race

code	finishing	q.kit	q.pack	a	b	c	kg.x1	vol.x1
133905-012	○ ivoire/marfil ral1013	x1	10	380	410	450	1,60	mc. 0.02

06 race-pack accessoires pour coque race

race-paquete de accesorios para carcasa race

code	finishing	q.kit	q.pack	kg.x1	vol.x1
137005-006	○ ivoire/marfil ral1013	x1	10	telaio in tondino/wire frame	0,085 mc. 0.001

07 race-panneau assise à revêtir

race-galleta asiento tapizable

code	finishing	q.kit	q.pack	kg.x1	vol.x1
132203-049	● noir/negro	x1	20	0,53	mc. 0.003

08 pack vis tbl+ fr. d.5x14 pour panneau à revêtir

paquete de tornillos tbl+ fr. d.5x14 para galleta tapizable

code	finishing	q.kit	q.pack
117003-071	● noir/negro	x4	200



for all colour codes, see page 341

race

4-legs



plastic colours

- bleu/azul ral5002
- orange/naranja ral2009
- violet/morado 145
- vert/verde 736
- ivoire/marfil ral1013
- gris/gris ral7003
- jaune/amarillo ral1012
- brun/marrón ral8022

main component sizes

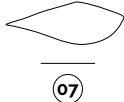
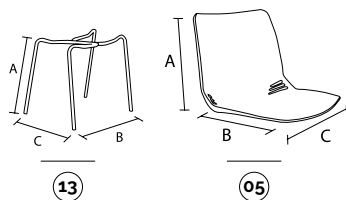

optionals

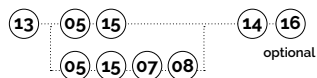
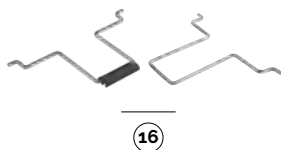

13 race-châssis 4 pieds tube d.18 sans embouts race-estructura 4 patas tubular d.18 sin tapones

code	finishing	q.kit	q.pack	a	b	c	kg.x1	vol.x1
112703-015	● noir/negro	x1	200	460	500	470	1.85	mc. 0.014
112707-015	● brun/marrón ral8022	x1	200	460	500	470	1.85	mc. 0.014
112704-015	● gris/gris ral7003	x1	200	460	500	470	1.85	mc. 0.014
112705-015	○ ivoire/marfil ral1013	x1	200	460	500	470	1.85	mc. 0.014
112710-015	● chromé/cromado	x1	200	460	500	470	1.85	mc. 0.014

14 pack embouts ronds d.18 noirs paquete de tacos redondos d.18 negros

code	finishing	q.kit	q.pack
137003-072	● noir/negro	x4	200
134205-181	○ blanc/blanco	x4	

05 race-coque entière modèle race race-carcasa completa modelo race

code	finishing	q.kit	q.pack	a	b	c	kg.x1	vol.x1
133916-012	● vert/verde 736	x1	10	380	410	450	1.60	mc. 0.02

15 race-pack accessoires pour coque race race-paquete de accesorios para carcasa race

code	finishing	q.kit	q.pack	kg.x1	vol.x1
137016-005	● vert/verde 736	x1	10	châssis tubes/estructura tubular	0,085 mc. 0,001

07 race-panneau assise à revêtir race-galleta asiento tapizable

code	finishing	q.kit	q.pack	kg.x1	vol.x1
132203-049	● noir/negro	x1	20	0,53	mc. 0,003

08 pack vis tbl+ fr. d.5x14 pour panneau à revêtir paquete de tornillos tbl+ fr. d.5x14 para galleta tapizable

code	finishing	q.kit	q.pack
117003-071	● noir/negro	x4	200

16 race-paire de grappins d'attelage latéral tige + plastique noir race-pareja de enganches laterales de varilla + plástico negro

code	finishing	q.kit	q.pack	kg.x1	vol.x1
113410-004	● chromé/cromado	x1	50	0,15	mc. 0,0004



for all colour codes, see page 341

race

swivel



plastic colours

- bleu/azul ral5002
- orange/naranja ral2009
- violet/morado 145
- vert/verde 736
- ivoire/marfil ral1013
- gris/gris ral7003
- jaune/amarillo ral1012
- brun/marrón ral8022

main component sizes

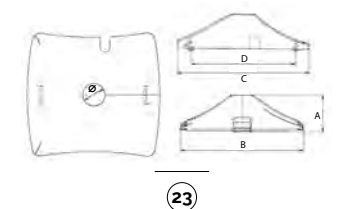
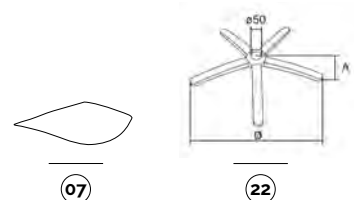
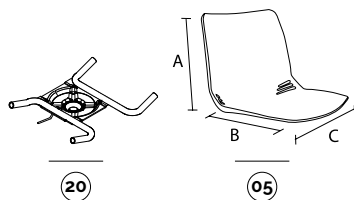

optionals

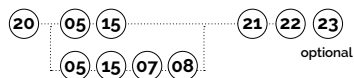

20 race-support pivotant au gaz pour coque race

race-soporte versión giratoria con mecanismo de gas para carcasa race

code	finishing	q.kit	q.pack	kg.x1	vol.x1
110903-070	● noir/negro	x1	8	1.40	mc. 0.005
110904-070	● gris/gris ral7003	x1	8	1.40	mc. 0.005

21 pack embouts couvre-tête ronds d.18

paquete de tacos redondos con aletas d18 negros

code	finishing	q.kit	q.pack
137003-070	● noir/negro	x4	200

05 race-coque entière modèle race

race-carcasa completa modelo race

code	finishing	q.kit	q.pack	a	b	c	kg.x1	vol.x1
133905-012	○ ivoire/marfil ral1013	x1	10	380	410	450	1.60	mc. 0.02

15 race-pack accessoires pour coque race

race-paquete de accesorios para carcasa race

code	finishing	q.kit	q.pack	kg.x1	vol.x1
137005-005	○ ivoire/marfil ral1013	x1	10	châssis tubes/estructura tubular	0,085 mc. 0.001

07 race-panneau assise à revêtir

race-galleta asiento tapizable

code	finishing	q.kit	q.pack	kg.x1	vol.x1
132203-049	● noir/negro	x1	20	0.53	mc. 0.003

08 pack vis tbt+ fr. d.5x14 pour panneau à revêtir

paquete de tornillos tbt+ fr. d.5x14 para galleta tapizable

code	finishing	q.kit	q.pack
117003-071	● noir/negro	x4	200

22 b40-base en métal avec cache-soudure

b40-base de metal con embellecedor soldadura

code	finishing	q.kit	q.pack	a	ø	kg.x1	vol.x1
110210-027	● chromé/cromado	x1	5	60	640	2.85	mc. 0.014

23 cpg-couverture en plastique pour châssis pivotant

cpg-cubierta de plástico para estructura versión giratoria

code	finishing	q.kit	q.pack	a	b	c	d	ø	kg.x1	vol.x1
130903-000	● noir/negro	x1	50	60	200	210	167	36	0.1	mc. 0.0015

CPG
plastic cover for swivel frame

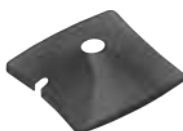

for all colour codes, see page 341

race

bench



plastic colours

- bleu/azul ral5002
- orange/naranja ral2009
- violet/morado 145
- vert/verde 736
- ivoire/marfil ral1013
- gris/gris ral7003
- jaune/amarillo ral1012
- brun/marrón ral8022

main component sizes

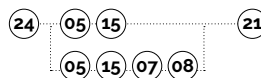
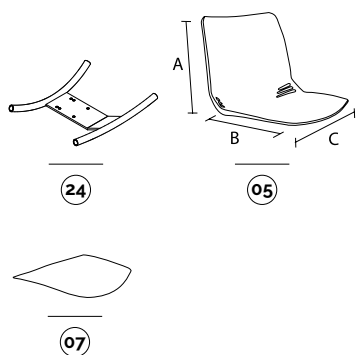

24 race-support pour raccordement coque race sur banquette race-soporte para enganche carcasa race en bancada

code	finishing	q.kit	q.pack	kg.x1	vol.x1
110703-210	● noir/negro	x1	15	1,30	mc. 0.004

21 pack embouts couvre-tête ronds d.18 paquete de tacos redondos con aletas d.18 negros

code	finishing	q.kit	q.pack
137003-070	● noir/negro	x4	200

05 race-coque entière modèle race race-carcasa completa modelo race

code	finishing	q.kit	q.pack	a	b	c	kg.x1	vol.x1
133905-012	○ ivoire/marfil ral1013	x1	10	380	410	450	1,60	mc. 0.02

15 race-pack accessoires pour coque race race-paquete de accesorios para carcasa race

code	finishing	q.kit	q.pack	kg.x1	vol.x1
137005-005	○ ivoire/marfil ral1013	x1	10	châssis tubes/estructura tubular	0,085 mc. 0.001

07 race-panneau assise à revêtir race-galleta asiento tapizable

code	finishing	q.kit	q.pack	kg.x1	vol.x1
132203-049	● noir/negro	x1	20	0,53	mc. 0.003

08 pack vis tbl+ fr. d.5x14 pour panneau à revêtir paquete de tornillos tbl+ fr. d.5x14 para galleta tapizable

code	finishing	q.kit	q.pack	kg.x1	vol.x1
117003-071	● noir/negro	x4	200		

for the bench components, see page 417



for all colour codes, see page 341

optionals

OPTIONAL
bench
connector



E-USB
bench plug



JIM
bench leg



plastic

90GM
bench leg



90GF
bench leg



91GM **NEW**
bench leg



100GM
bench leg



200GM
bench leg



PIONEER
bench arm



metal

CUT
bench leg



SLIM
bench leg



CUT
bench arm



SLIM
bench arm



aluminium

race

optional colour codes

shell colour codes



05 coque en plastique
carcasa de plástico

- 133915-012 bleu/azul ral5002
- 133907-012 orange/naranja ral2009
- 133914-012 violet/morado 145
- 133916-012 vert/verde 736
- 133905-012 ivoire/marfil ral1013
- 133904-012 gris/gris ral7003
- 133908-012 jaune/amarillo ral1012
- 133907-013 brun/marrón ral8022



accessory colour codes



06 accessoires en plastique - châssis coulissant
accessorios de plástico - patin de varilla

- 137015-006 bleu/azul ral5002
- 137007-007 orange/naranja ral2009
- 137014-006 violet/morado 145
- 137016-006 vert/verde 736
- 137005-006 ivoire/marfil ral1013
- 137004-006 gris/gris ral7003
- 137008-006 jaune/amarillo ral1012
- 137007-008 brun/marrón ral8022



15 accessoires en plastique - châssis 4 pieds
accessorios de plástico - estructura 4 patas

- 137015-005 bleu/azul ral5002
- 137007-005 orange/naranja ral2009
- 137014-005 violet/morado 145
- 137016-005 vert/verde 736
- 137005-005 ivoire/marfil ral1013
- 137004-005 gris/gris ral7003
- 137008-005 jaune/amarillo ral1012
- 137007-006 brun/marrón ral8022

armrest colour codes



10 accoudoir en plastique - châssis coulissant
brazo de plástico - patin de varilla

- 131704-019 gris/gris ral7003
- 131703-019 noir/negro
- 131705-019 ivoire/marfil ral1013



18 accoudoir en plastique - châssis 4 pieds
brazo de plástico - estructura 4 patas

- 131704-017 gris/gris ral7003
- 131703-017 noir/negro
- 131705-017 ivoire/marfil ral1013





smile



discover more about
Smile Collection

Une large monocoque en plastique confortable et enveloppante, caractérisée par un design caractéristique et éclatant, grâce en particulier à la gamme de couleurs vives qui est proposée.

Un grand choix de châssis, allant du tabouret au banc, est disponible dans différentes finitions. Ce modèle peut donc s'adapter à tout type d'environnement, de la maison au bureau. Smile se nettoie et s'empile facilement, c'est pourquoi cette chaise sera également parfaite dans un environnement recevant le public.

Una monocarcasa de plástico amplia, confortable y envolvente, caracterizada por un diseño distintivo y fresco, también por la gama de colores vivos en los que se propone.

Gracias a la elección vasta de estructuras, que comprende taburetes y bancadas en varios acabados, se adapta a todos los tipos de ambiente, desde la casa hasta la oficina. Smile, al ser apilable y fácilmente limpiable, se adapta perfectamente también al ambiente de la colectividad.

smile

slide

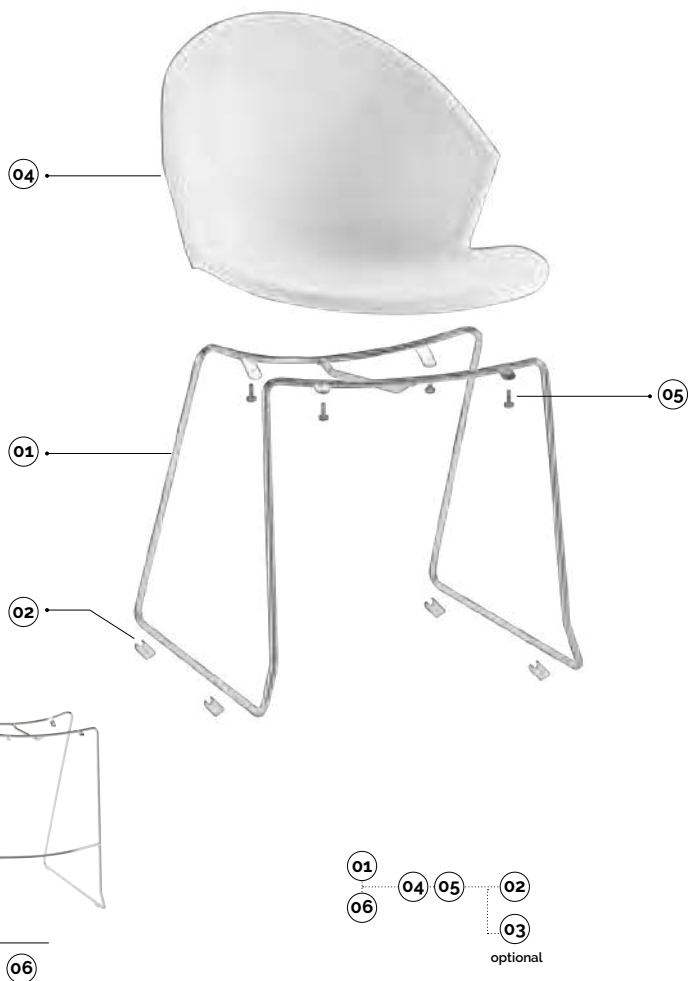

plastic colours

- noir/negro
- blanc/blanco 218
- bleu/azul 5002

main component sizes

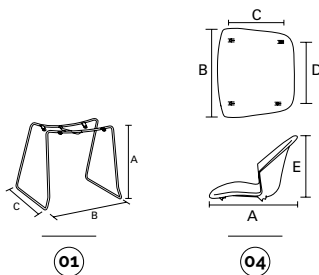

optionals

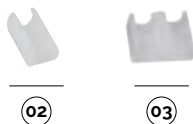

01 smile-tabouret en tige chromé pour coque sans embouts
smile-taburete de varilla cromado para carcasa sin tapones

code	finishing	q.kit	q.pack	a	b	c	kg.x1	vol.x1
113410-018	● chromé/cromado	x1	100	450	500	500	3,20	mc. 0.04

02 pack de bases à pince anti-rotation pour tige couleur neutre
paquete de bases con pinza antirrotación para varilla de color neutro

code	finishing	q.kit	q.pack
137006-070	○ neutre/neutro	x4	200

03 base plate à double clipsage en pe pour fil
base plana con pinza doble de pe para varilla

code	finishing	q.kit
134006-021	○ neutre/neutro	x4

04 smile-coque entière modèle smile
smile-carcasa completa modelo smile

code	finishing		q.kit	q.pack	a	b	c	d	e	kg.x1	vol.x1
133905-053	○ blanc/blanco	218	x1	10	540	510	235	277	395	1,50	mc. 0.015

05 vis auto-perceuse 5,5x19 tête cylindrique croix zinguée (vis fixation coque)
tornillo autoroscante 5,5x19 cabeza cilíndrica en cruz galvanizado (tornillo fijación carcasa)

code	finishing	q.kit	q.pack
110603-630	○ zinguée/galvanizado	x4	60

06 smile-tabouret haut en tige chromé pour coque sans embouts
smile-taburete alto de varilla cromado para carcasa sin tapones

code	finishing	q.kit	q.pack	a	b	c	kg.x1	vol.x1
113410-019	● chromé/cromado	x1	50	700	500	560	5,00	mc. 0.08



for all colour codes, see page 347

smile

4-legs



plastic colours

- noir/negro
- blanc/blanco 218
- bleu/azul 5002

07 04 09 08

main component sizes

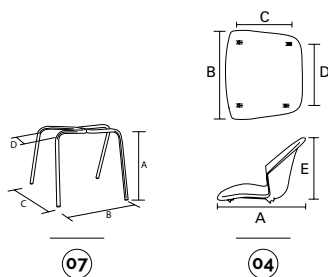

07 tabouret 4 pieds en tube d.20 sans embouts

taburete 4 patas tubular d. 20 sin tapones

code	finishing	q.kit	q.pack	a	b	c	d	kg.x1	vol.x1
112703-030	● noir/negro	x1	150	430	440	540	260	1,92	mc. 0,02
112704-030	○ gris/gris	x1	150	430	440	540	260	1,92	mc. 0,02
112710-030	● chromé/cromado	x1	150	430	440	540	260	1,92	mc. 0,02

08 bouchon à ailettes d.20 noir

tapón con aletas d. 20 negro

code	finishing	q.kit
134203-200	● noir/negro	x4

04 smile-coque entière modèle smile

smile-carcasa completa modelo smile

code	finishing	q.kit	q.pack	a	b	c	d	e	kg.x1	vol.x1
133905-053	○ blanc/blanco 218	x1	10	540	510	235	277	395	1,50	mc. 0,015

09 pack des vis hilo 5,5x30 tête evasée croix zinguée (vis pour fixation coque)

paquete de tornillos hilo 5,5x30 cabeza avellanada en cruz galvanizado (tornillo para fijación carcasa)

code	finishing	q.kit	q.pack
117011-070	○ zinguée/galvanizado	x4	200



for all colour codes, see page 347

smile

swivel



plastic colours

- noir/negro
- blanc/blanco 218
- bleu/azul 5002

10 04 09 11 12
optional

main component sizes

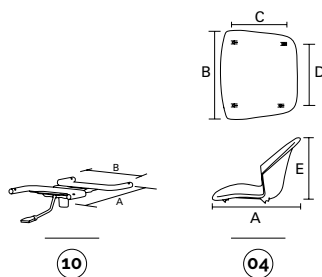

optionals

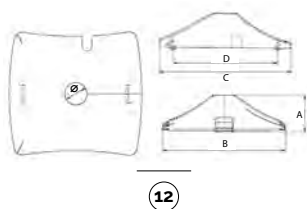

10 smile-support pivotant au gaz pour coque smile
smile-soporte versión giratoria con mecanismo de gas para carcasa smile

code	finishing	q.kit	q.pack	a	b	kg.x1	vol.x1
110903-030	● noir/negro	x1	10	277	235	1,40	mc. 0,004
110904-008	● gris/gris	x1	10	277	235	1,40	mc. 0,004

11 embout couvre-tête d.20 noir
tapón embellecedor d.20 negro

code	finishing	q.kit
134103-200	● noir/negro	x4

04 smile-coque entière modèle smile
smile-carcasa completa modelo smile

code	finishing		q.kit	q.pack	a	b	c	d	e	kg.x1	vol.x1
133915-053	● bleu/azul	5002	x1	10	540	510	235	277	395	1,50	mc. 0,015

09 pack des vis hilo 5,5x30 tête evasée croix zinguée (vis pour fixation coque)
paquete de tornillos hilo 5,5x30 cabeza avellanada en cruz galvanizado (tornillo para fijación carcasa)

code	finishing	q.kit	q.pack
117011-070	◐ zinguée/galvanizado	x4	200

12 cpg-couverture en plastique pour châssis pivotant
cpg-cubierta de plástico para estructura versión giratoria

code	finishing	q.kit	q.pack	a	b	c	d	ø	kg.x1	vol.x1
130903-000	● noir/negro	x1	50	60	200	210	167	36	0,1	mc. 0,0015

CPG
plastic cover for swivel frame



➔ for all colour codes, see page 347

smile

bench



plastic colours

- noir/negro
- blanc/blanco 218
- bleu/azul 5002

13 04 09 11

13 smile-support pour raccordement coque smile sur banquette smile-soporte para enganche carcasa smile en bancada

code	finishing	q.kit	q.pack	a	b	kg.x1	vol.x1
110703-087	● noir/negro	x1	10	277	235	1.40	mc. 0.004

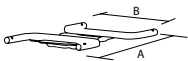

13

for the components below, see previous pages



for all colour codes, see below

04 09 11

main component sizes

for the bench components, see page 417

optionals

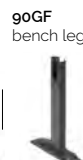
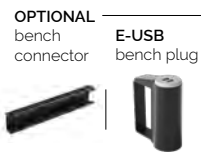

plastic

metal

aluminium

smile

optional colour codes



shell colour codes

04 coque en plastique
carcasa de plastico

- 133903-053 noir/negro
- 133905-053 blanc/blanco 218
- 133915-053 bleu/azul 5002





eden



discover more about
Eden Collection

Grâce à son design simple et essentiel, ce modèle s'adapte à plusieurs contextes différents: des structures éducatives aux environnements domestiques.

La chaise comme le dossier sont proposés dans plusieurs couleurs.

Eden est empilable et disponible dans la version tabouret.

Con su diseño simple y esencial se adapta a marcos muy diferentes entre sí, tales como el sector educativo y el ambiente de la casa.

El asiento y el respaldo están disponibles en colores diferentes.

Eden es apilable y existe también en la versión taburete.

eden

4-legs

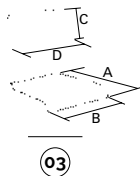
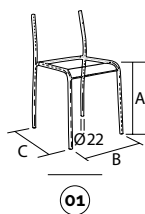
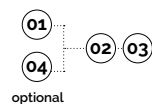

main component sizes

01 eden-châssis fixe sans embouts
eden-marco fijo sin tapones

code	finishing	q.kit	q.pack	a	b	c	kg.x1	vol.x1
111903-030	● noir/negro	x1	100	470	420	460	3,00	mc. 0.03
111904-020	● gris/gris	x1	100	470	420	460	3,00	mc. 0.03
111910-030	● chromé/cromado	x1	100	470	420	460	3,00	mc. 0.03

02 pack embouts ronds d.22 noirs
paquete de tacos redondos d.22 negros

code	finishing	q.kit	q.pack
137003-073	● noir/negro	x4	200

03 eden-dossier et siège en plastique
eden-respaldo y asiento de plástico

code	finishing	q.kit	q.pack	a	b	c	d	kg.x1	vol.x1
134003-100	● noir/negro	x1	20	400	390	180	400	1,50	mc. 0.013
134015-020	● bleu/azul	x1	20	400	390	180	400	1,50	mc. 0.013
134005-020	○ ivoire/marfil	x1	20	400	390	180	400	1,50	mc. 0.013

eden

4-legs/frame option

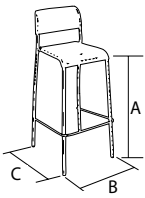

04

main component sizes

04 eden-tabouret haut fixe sans embouts
eden-taburete alto fijo sin tapones

code	finishing	q.kit	q.pack	a	b	c	kg.x1	vol.x1
111903-032	● noir/negro	x1	50	720	420	460	4.10	mc. 0.09
111904-022	● gris/gris	x1	50	720	420	460	4.10	mc. 0.09
111910-029	● chromé/cromado	x1	50	720	420	460	4.10	mc. 0.09

02 pack embouts ronds d.22 noirs
paquete de tacos redondos d.22 negros

code	finishing	q.kit	q.pack
137003-073	● noir/negro	x4	200





paco



discover more about
Paco Collection

Un tabouret de style classique, doté d'une assise confortable se composant d'une monocoque en plastique, proposée dans plusieurs couleurs, et d'une structure moulée en acier, chrome ou grise.

Paco est pratique et polyvalent et il a été conçu pour des environnements professionnels.

Es un taburete de aires clásicos, con un asiento cómodo monocarcasa de plástico, disponible en tres colores distintos, y una estructura perfilada en acero, cromada o gris.

Paco es práctico y versátil, pensado para los ambientes contract.

paco

4-legs



plastic colours

- anthracite/antracita ppl17
- beige/beige ppl09
- bleu/azul ppl14

01 02

main component sizes

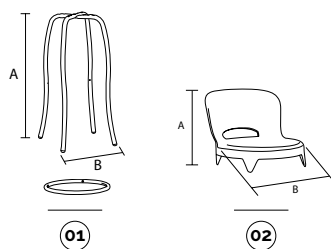

01 paco-châssis démonté pour tabouret haut avec accessoires pour le montage
paco-estructura desmontada para taburete alto con accesorios para el montaje

code	finishing	q.kit	q.pack	a	b	kg.x1	vol.x1
110604-090	● gris/gris	x1	6	800	370	3,45	mc. 0.02
110610-080	● chromé/cromado	x1	6	800	370	3,45	mc. 0.02

02 paco-coque entière en plastique
paco-carcasa completa de plástico

code	finishing	q.kit	q.pack	a	b	kg.x1	vol.x1
133904-025	● anthracite/antracitappl17	x1	10	230	380	1,38	mc. 0.02
133905-040	● beige/beige ppl09	x1	10	230	380	1,38	mc. 0.02
133915-040	● bleu/azul ppl14	x1	10	230	380	1,38	mc. 0.02

le tabouret standard comprend le pack accessoires pour le montage
el taburete estándar comprende el paquete de accesorios para el montaje

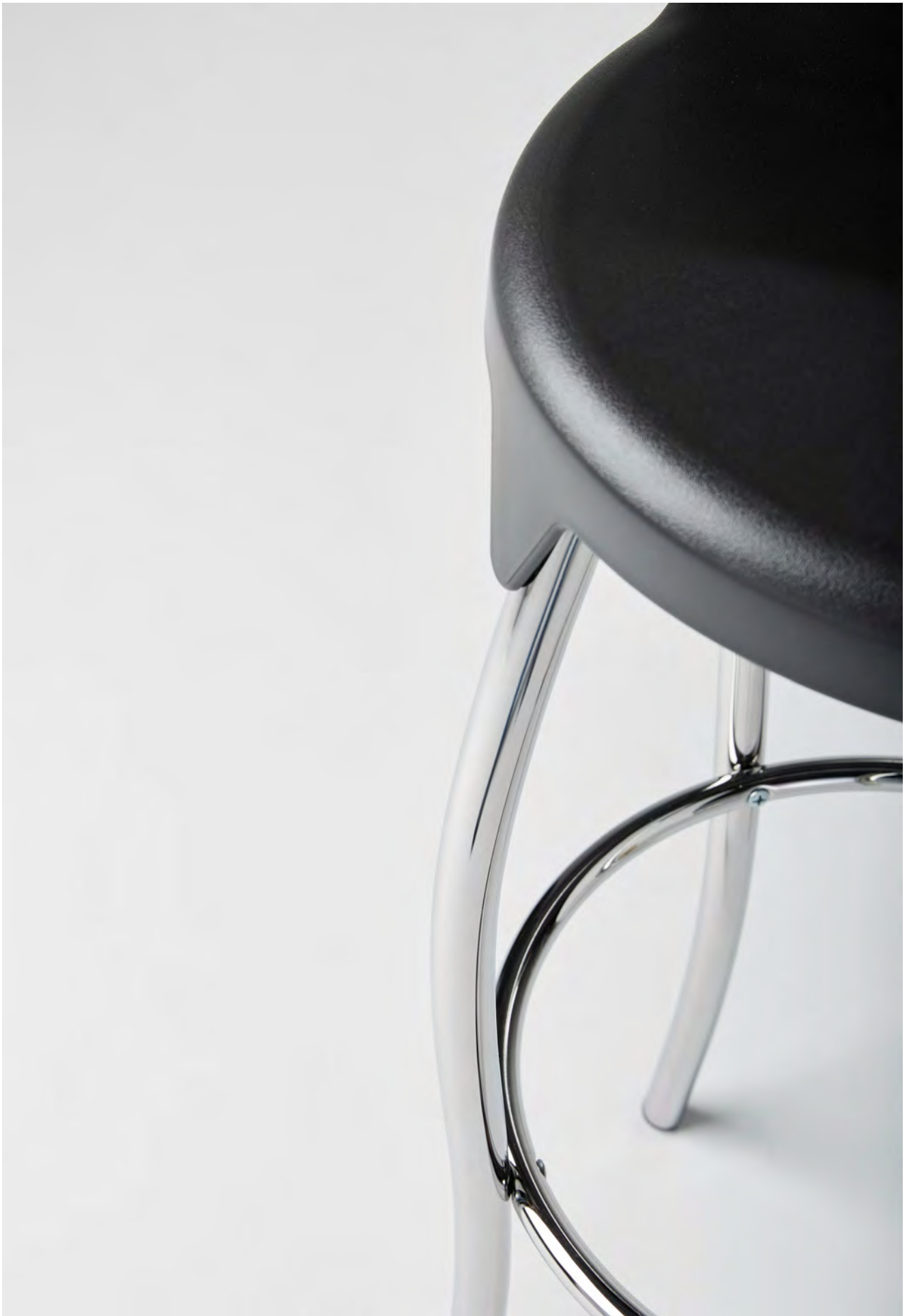



vicenza



discover more about
Vicenza Collection

Une assise au design minimaliste et essentiel.

Sa coque en plastique, proposée dans différentes couleurs, peut se combiner avec une large série de châssis, ce qui fait de ce modèle une chaise parfaite pour différents types environnements, notamment le secteur accueillant le public.

Elle est empilable et proposée avec des accroches latérales. Elle existe également dans la version avec une tablette.

El asiento con un diseño minimalista y esencial.

La carcasa de plástico en varios colores se combina con una serie, amplia y completa de estructuras, para adaptarse a ambientes diferentes, sobre todo al de la colectividad.

Es apilable y se propone también con enganches laterales y en la versión con pala.

Plus

• Certification EN 16139:2013+AC2013 Niveau 1.

• *Certificación EN 16139:2013+AC2013 Nivel 1.*



**trolley
available**



**certified
product**

vicenza

4-legs



plastic colours

- rouge/rojo ral 3002
- noir/negro
- bleu/azul ral 5002

main component sizes

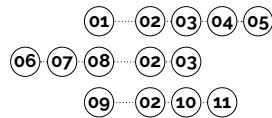
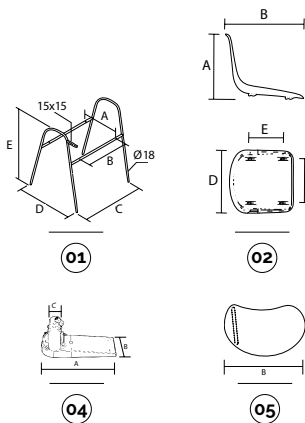

01 vicenza-tabouret pour coque vicenza avec porte-tablette et accoudoir tube ø18 embouts montés
vicenza-taburete para carcasa vicenza con pala y brazo tubular ø18 tapones montados

code	finishing	q.kit	q.pack	a	b	c	d	e	kg.x1	vol.x1
111903-007	● noir/negro	x1	80	255	315	486	500	630	2,50	mc. 0,040
111910-012	● chromé/cromado	x1	80	255	315	486	500	630	2,50	mc. 0,040

02 vicenza-coque entière modèle vicenza
vicenza-carcasa completa modelo vicenza

code	finishing	q.kit	q.pack	a	b	c	d	e	kg.x1	vol.x1
133902-002	● rouge/rojo ral 3002	x2	12	395	470	315	430	255	1,30	mc. 0,014

03 pack de vis hilo d.5x35 tête évasée croix zinguée (vis pour fixation coque)
paquete de tornillos hilo d.5x35 cabeza avellanada en cruz galvanizados (tornillo para fijación carcasa)

code	finishing	q.kit	q.pack
117011-070	● zinguée/galvanizado	x4	200

04 spt2-rotule pour tablette en thermoplastique
spt2-articulación para pala de termoplástico

code	finishing	q.kit	q.pack	a	b	c	kg.x1	vol.x1
134003-039	● noir/negro	x1	20	180	66	15x15	0,35	mc. 0,0006

05 bean-tablette en thermoplastique épaisseur 16 mm
bean-pala de termoplástico grosor 16 mm

code	finishing	q.kit	q.pack	a	b	kg.x1	vol.x1
134003-044	● noir/negro	x1	20	235	370	0,40	mc. 0,002



vicenza-chariot porte-chaises noir avec accessoires
vicenza-carro para sillas con accesorios negro

code	finishing
110803-365	● noir/negro



for all colour codes, see page 361

TLT tablet TLT2 tablet TLT3 tablet BEAN tablet TL02 tablet SPT2 mechanism tablet SPTA mechanism antipanic



for writing tablet options, see page 404/405

vicenza

frame options



06

07

08

09



06

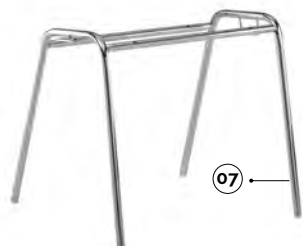

07



08

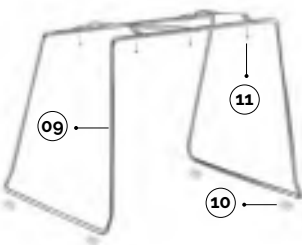

09

11

10

06 vicenza-tabouret pour coque avec accoudoirs tube Ø18 embouts sous pieds montés
vicenza-taburete para carcasa con brazos tubular Ø18 tapones para pies montados

code	finishing	q.kit	q.pack	a	b	c	d	e	kg.x1	vol.x1
111903-003	● noir/negro	x1	80	255	315	486	500	630	2,50	mc. 0.040
111910-010	● chromé/cromado	x1	80	255	315	486	500	630	2,50	mc. 0.040

07 vicenza-tabouret pour coque avec attelage tube Ø18 embouts sous pieds montés
vicenza-taburete para carcasa con enganche tubular Ø18 tapones para pies montados

code	finishing	diameter	q.kit	q.pack	a	b	c	d	e	f	kg.x1	vol.x1
111903-001	● noir/negro	18	x1	200	255	315	500	480	460	438	1,90	mc. 0.020
111910-002	● chromé/cromado	18	x1	200	255	315	500	480	460	438	1,90	mc. 0.020
111903-249	● noir/negro	20	x1	200	255	315	505	484	460	438	2,05	mc. 0.020
111910-249	● chromé/cromado	20	x1	200	255	315	505	484	460	438	2,05	mc. 0.020
111903-253	● noir/negro	22	x1	180	255	315	510	484	460	438	2,30	mc. 0.020
111910-253	● chromé/cromado	22	x1	180	255	315	510	484	460	438	2,30	mc. 0.020

08 vicenza-tabouret pour coque en tube Ø18 embouts sous pieds montés
vicenza-taburete para carcasa tubular Ø18 tapones para pies montados

code	finishing	diameter	q.kit	q.pack	a	b	c	d	e	f	kg.x1	vol.x1
111903-002	● noir/negro	18	x1	200	255	315	500	478	460	438	1,85	mc. 0.020
111910-001	● chromé/cromado	18	x1	200	255	315	500	478	460	438	1,85	mc. 0.020
111903-248	● noir/negro	20	x1	200	255	315	505	484	460	438	2,00	mc. 0.020
111910-248	● chromé/cromado	20	x1	200	255	315	505	484	460	438	2,00	mc. 0.020
111903-252	● noir/negro	22	x1	180	255	315	510	484	460	438	2,25	mc. 0.020
111910-252	● chromé/cromado	22	x1	180	255	315	510	484	460	438	2,25	mc. 0.020

09 filo-châssis en tige d.11
filo-estructura de varilla d.11

code	finishing	q.kit	q.pack	a	b	c	kg.x1	vol.x1
113410-010	● chromé/cromado	x1	100	470	540	480	3,10	mc. 0.04

10 pack de bases à pince anti-rotation pour tige couleur neutre
paquete de bases con pinza antirrotación para varilla de color neutro

code	finishing	q.kit	q.pack
137006-070	○ neutre/neutro	x4	200

11 vis auto-perceuse aggloméré tc+ Ø 5,5x19 pour fixation assise
tornillo autoroscante para panel de aglomerado tc+ Ø 5,5x19 para fijación asiento

code	finishing	q.kit
117811-180	○ zinguée/galvanizado	x4

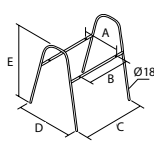

06

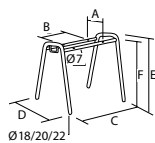

07

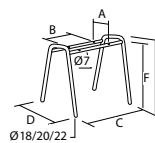

08

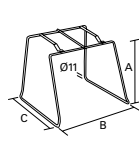

09

optionals

vicenza

swivel



plastic colours

- rouge/rojo ral 3002
- noir/negro
- bleu/azul ral 5002

main component sizes

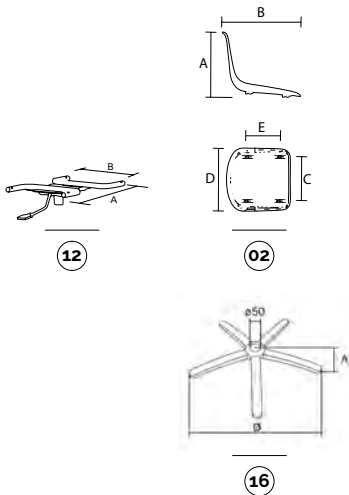

optionals

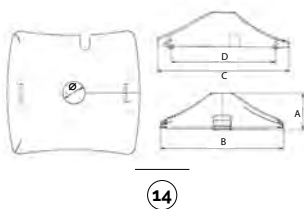

12 02 03 13 14 16
optional

12 vicenza gnr-châssis pivotant au gaz sans accessoires

vicenza gnr-estructura versión giratoria con mecanismo de gas sin accesorios

code	finishing	q.kit	q.pack	a	b	kg.x1	vol.x1
110903-006	● noir/negro	x1	10	315	255	1.40	mc. 0.004

02 vicenza-coque entière modèle vicenza

vicenza-carcasa completa modelo vicenza

code	finishing	q.kit	q.pack	a	b	c	d	e	kg.x1	vol.x1
133902-002	● rouge/rojo ral 3002	x2	12	395	470	315	430	255	1.30	mc. 0.014

03 pack de vis hilo d.5x35 tête évasée croix zinguée (vis pour fixation coque)

paquete de tornillos hilo d.5x35 cabeza avellanada en cruz galvanizados (tornillo para fijación carcasa)

code	finishing	q.kit	q.pack
117011-070	● zinguée/galvanizado	x4	200

13 pack embouts couvre-tête ø18 noir

paquete de tapones embellecedores d.18 negro

code	finishing	q.kit	q.pack
137003-070	● noir/negro	x4	200

14 cpg-couverture en plastique pour châssis pivotant

cpg-cubierta de plástico para estructura versión giratoria

code	finishing	q.kit	q.pack	a	b	c	d	ø	kg.x1	vol.x1
130903-000	● noir/negro	x1	50	60	200	210	167	36	0.1	mc. 0.0015

16 b40-base en métal avec cache-soudure

b40-base de metal con embellecedor soldadura

code	finishing	q.kit	q.pack	a	ø	kg.x1	vol.x1
110210-027	● chromé/cromado	x1	5	60	640	2.85	mc. 0.014

CPG
plastic cover for swivel frame

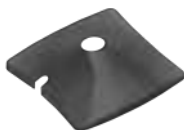

for all colour codes, see page 361

vicenza

bench



plastic colours

- rouge/rojo ral 3002
- noir/negro
- bleu/azul ral 5002

15 02 03 13

15 support pour raccordement coque vicenza sur banquette
soporte para enganche carcasa vicenza en bancada

code	finishing	q.kit	q.pack	a	b	kg.x1	vol.x1
110703-016	● noir/negro	x1	10	315	255	1.40	mc. 0.004



15

for the components below, see previous pages

02 03 13

for all colour codes, see below

for the bench components, see page 417

main component sizes

optionals

OPTIONAL
bench
connector



E-USB
bench plug



JIM
bench leg



plastic

90GM
bench leg



90GF
bench leg



91GM **NEW**
bench leg



100GM
bench leg



200GM
bench leg



PIONEER
bench arm



CUT
bench leg



SLIM
bench leg



CUT
bench arm



SLIM
bench arm



metal

aluminium

vicenza

optional colour codes

shell colour codes



02 coque entière
carcasa completa

- 133902-002 rouge/rojo ral 3002
- 133903-001 noir/negro
- 133915-005 bleu/azul ral 5002





90



discover more about
go Collection

La série go se caractérise par un design classique et la qualité certifiée de Alba.

Un large assortiment de châssis et de composants complètent l'offre d'un produit essentiel et polyvalent, capable de satisfaire tout type d'exigence, en faisant de cette chaise un objet parfait pour tout type d'environnement.

La Serie go se caracteriza por un diseño clásico y por su reconocida calidad Alba.

Un surtido amplio de estructuras y componentes completa la oferta de un producto esencial y versátil, que cumple todas las exigencias en los ámbitos más diversificados, para convertirse en una silla de grandes números.

Plus

- Certification UNI 10977:2002 Niveau 4.
- *Certificación UNI 10977:2002 Nivel 4.*



certified
product

90

4-legs

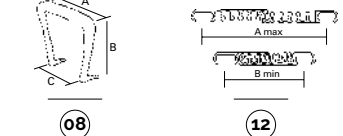
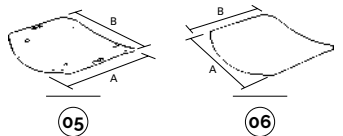
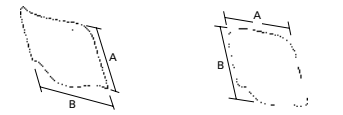
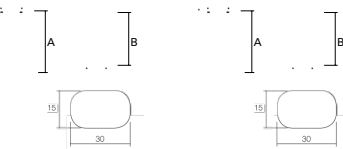
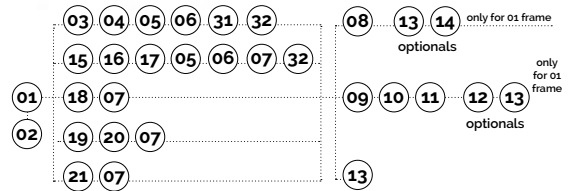
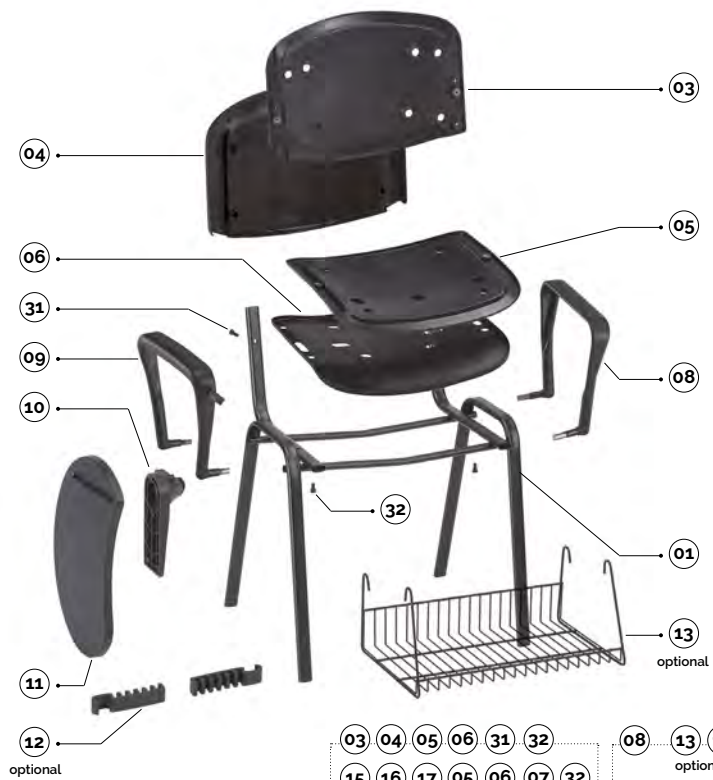

attelage latéral mâle+female en plastique • 2 vis
enganche lateral macho+hembra de plástico • 2 tornillos
134003-132

01 g2-châssis pour chaise en tube ovale 30x15 avec embouts latéraux et sous-pieds montés

g2-estructura para silla tubular oval 30x15 con tapones laterales montados para los pies

code	finishing	arm attach	q.kit	q.pack	a	b	kg.x1	vol.x1
112003-005	● noir/negro	12	x1	160	450	425	3,00	mc. 0.021
112003-004	● noir/negro	14	x1	160	450	425	3,00	mc. 0.021
112004-000	● gris/gris	12	x1	160	450	425	3,00	mc. 0.021
112004-002	● gris/gris	14	x1	160	450	425	3,00	mc. 0.021
112010-008	● chromé/cromado	12	x1	160	450	425	3,00	mc. 0.021
112010-005	● chromé/cromado	14	x1	160	450	425	3,00	mc. 0.021

02 g2-châssis pour chaise en tube ovale 30x15 avec attelage latéral en métal soudé, embouts latéraux et sous-pieds montés

g2-estructura para silla tubular oval 30x15 con enganche lateral metálico soldado y tapones laterales montados para los pies

code	finishing	arm attach	q.kit	q.pack	a	b	kg.x1	vol.x1
112003-016	● noir/negro	12	x1	160	450	425	3,00	mc. 0.021
112003-015	● noir/negro	14	x1	160	450	425	3,00	mc. 0.021
112004-007	● gris/gris	12	x1	160	450	425	3,00	mc. 0.021
112004-008	● gris/gris	14	x1	160	450	425	3,00	mc. 0.021
112010-016	● chromé/cromado	12	x1	160	450	425	3,00	mc. 0.021
112010-015	● chromé/cromado	14	x1	160	450	425	3,00	mc. 0.021

03 goshi-dossier interne en plastique

goshi-respaldo interno de plástico

code	finishing	q.kit	q.pack	a	b	kg.x1	vol.x1
132103-002	● noir/negro	x1	40	330	470	0,60	mc. 0.004

04 goshe-couvre-dossier externe en plastique

goshe-respaldo externo de plástico

code	finishing	q.kit	q.pack	a	b	kg.x1	vol.x1
132103-001	● noir/negro	x1	30	475	335	0,40	mc. 0.004

05 gosdi-assise interne en plastique

gosdi-asiento interno de plástico

code	finishing	q.kit	q.pack	a	b	kg.x1	vol.x1
132203-002	● noir/negro	x1	30	460	400	0,80	mc. 0.004

06 gosde-assise externe en plastique

gosde-asiento externo de plástico

code	finishing	q.kit	q.pack	a	b	kg.x1	vol.x1
132203-001	● noir/negro	x1	80	410	465	0,40	mc. 0.003

31 vis tsp+ m6x20 zinguée blanche

tornillo tsp+ m6x20 galvanizada blanca

code	finishing	q.kit
117711-203	● zinguée blanc/galvanizado blanco	x2

32 vis tsp+ m6x25 zinguée blanche

tornillo tsp+ m6x25 galvanizada blanca

code	finishing	q.kit
117711-199	● zinguée blanc/galvanizado blanco	x2

08 gob-accouoir en nylon

gob-brazo de nailon

code	finishing	arm attach	q.kit	q.pack	a	b	c	kg.x1	vol.x1
131703-002	● noir/negro	14	x2	20	290	250	190	0,80	mc. 0.0026
131703-004	● noir/negro	12	x2	20	290	250	190	0,80	mc. 0.0026

12 clipsages réglables pour tube ovale 15x30 pp

pareja pinzas regulables para tubular oval 15x30 pp

code	finishing	q.kit	q.pack	a	b
134003-002	● noir/negro	x1	200	214	134

13 g2c-porte-revues

g2c-rejilla revistero

code	finishing	q.kit	q.pack	kg.x1	vol.x1
113403-001	● noir/negro	x1	25	0,975	mc. 0.03
113410-020	● chromé/cromado	x1	25	0,975	mc. 0.03

main component sizes

optionals

90

4-legs/tablet accessories

main component sizes



09

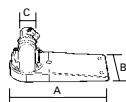

10

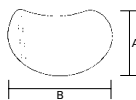

11

09 g0bp-accoudoir en nylon avec attelage porte tablette
gobp-brazo de nailon con enganche para pala

code	finishing	arm attach	q.kit	q.pack	a	b	c	d	kg.x1	vol.x1
131703-001	● noir/negro	14	x1	20	290	250	190	15x15	0,80	mc. 0,0026
131703-003	● noir/negro	12	x1	20	290	250	190	15x15	0,80	mc. 0,0026

10 sp2t-rotule pour tablette en thermoplastique
sp2t-articulación para pala de termoplástico

code	finishing	q.kit	q.pack	a	b	c	kg.x1	vol.x1
134003-039	● noir/negro	x1	20	180	66	15x15	0,35	mc. 0,0006

11 bean-tablette en thermoplastique ovale épaisseur 16 mm
bean-pala de material termoplástico oval grosor 16 mm

code	finishing	q.kit	q.pack	a	b	kg.x1	vol.x1
134003-044	● noir/negro	x1	20	235	370	0,40	mc. 0,002

TLT tablet TLT2 tablet TLT3 tablet BEAN tablet TL02 tablet SPT2 mechanism tablet SPTA mechanism antipanico



for writing tablet options, see page 404/405

4-legs/backrest and seat options

main component sizes

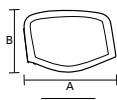

15

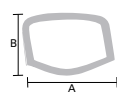

16

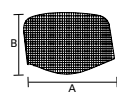

17



15 isonet-châssis dossier en plastique avec vis pour treillis
isonet-estructura respaldo de plástico con tornillos para malla

code	finishing	q.kit	q.pack	a	b	kg.x1	vol.x1
132103-003	● noir/negro	x1	25	470	345	0,42	mc. 0,006

16 isonet-cadre dossier en plastique pour treillis
isonet-marco respaldo de plástico para malla

code	finishing	q.kit	q.pack	a	b	kg.x1	vol.x1
132103-004	● noir/negro	x1	25	470	345	0,31	mc. 0,004

17 isonet-treillis pour dossier
isonet-malla para respaldo

code	finishing	q.kit	q.pack	a	b	kg.x1	vol.x1
132105-500	○ blanc/blanco	x1	25	550	400	0,14	mc. 0,0057
132103-500	● noir/negro	x1	25	550	400	0,14	mc. 0,0057
132102-500	● rouge/rojo	x1	25	550	400	0,14	mc. 0,0057

07 vis tête évasée croix m6x18 brunie noire-fixation siège/ dossier hêtre
tornillo cabeza avellanada en cruz m6x18 bruñido negro - fijación asiento / respaldo haya

code	finishing	q.kit
117703-195	● noir/negro	x4

and · 05 06 32

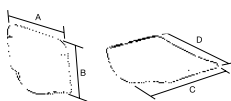

18



18 novx-siège et dossier en plastique pour châssis en tube ovale et en tube elliptique
novx-asiento y respaldo de plástico disponibles para estructura tubular oval y tubular elíptico

code	finishing	q.kit	q.pack	a	b	c	d	kg.x1	vol.x1
134002-001	● rouge/rojo	x1	20	470	315	460	400	1,21	mc. 0,008
134003-119	● noir/negro	x1	20	470	315	460	400	1,21	mc. 0,008
134015-003	● bleu/azul	x1	20	470	315	460	400	1,21	mc. 0,008

and · 07



19



19 prisma-siège et dossier en plastique pour châssis en tube ovale et en tube elliptique
prisma-asiento y respaldo de plástico disponibles para estructura tubular oval y tubular elíptico

code	finishing	q.kit	q.pack	a	b	c	d	kg.x1	vol.x1
134003-110	● noir/negro	x1	10	470	330	460	430	1,60	mc. 0,016

20 prisma-panneau assise pour tapisserie
prisma-panel asiento para tapizar

code	finishing	q.kit	q.pack	a	b	kg.x1	vol.x1
132203-010	● noir/negro	x1	20	400	400	0,40	mc. 0,004

and · 07

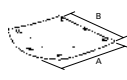

20



21 goshsdif-dossier + siège multicouches verni hêtre + 4 embouts
goshsdif-respaldo + asiento contrachapado pintado haya + 4 terminales

code	finishing	q.kit	q.pack	a	b	c	d	e	f	kg.x1	vol.x1
124007-000	● hêtre/haya	x1	10	325	465	415	460	10	10	2,70	mc. 0,07

and · 07

90

4-legs w/armrests

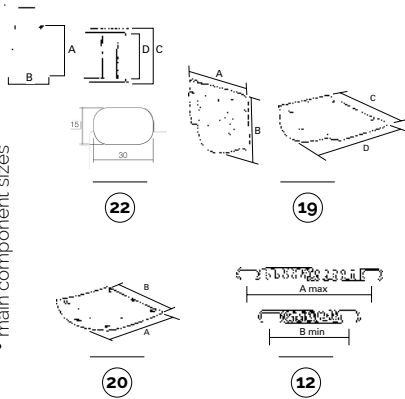
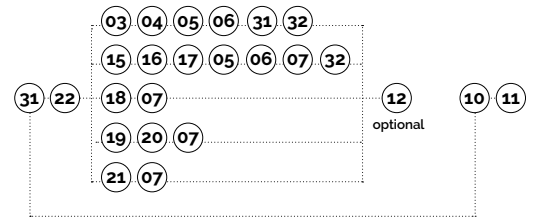

22 g4-châssis pour chaise en tube ovale 30x15 avec accoudoirs, embouts latéraux et sous pieds montés
g4-estructura para silla tubular oval 30x15 con brazos y tapones laterales y para los pies montados

code	finishing	q.kit	q.pack	a	b	c	d	kg.x1	vol.x1
112003-020	● noir/negro	x1	68	450	470	545	425	3,80	mc. 0,042
112004-021	● gris/gris	x1	68	450	470	545	425	3,80	mc. 0,042
112010-040	● chromé/cromado	x1	68	450	470	545	425	3,80	mc. 0,042

19 prisma-siège et dossier en plastique pour châssis en tube ovale et en tube elliptique
prisma-asiento y respaldo de plástico disponibles para estructura tubular oval y tubular elíptico

code	finishing	q.kit	q.pack	a	b	c	d	kg.x1	vol.x1
134003-110	● noir/negro	x1	10	470	330	460	430	1,60	mc. 0,016

20 prisma-panneau assise pour tapisserie
prisma-panel asiento para tapizar

code	finishing	q.kit	q.pack	a	b	kg.x1	vol.x1
132203-010	● noir/negro	x1	20	400	400	0,40	mc. 0,004

07 vis tête évasée croix m6x18 brunie noire-fixation siège/ dossier hêtre
tornillo cabeza avellanada en cruz m6x18 bruñido negro - fijación asiento / respaldo haya

code	finishing	q.kit
117703-195	● noir/negro	x4

12 clipsages réglables pour tube ovale 15x30 pp
pareja pinzas regulables para tubular oval 15x30 pp

code	finishing	q.kit	q.pack	a	b
134003-002	● noir/negro	x1	200	214	134

main component sizes

90

4-legs with armrests/tablet accessories

main component sizes

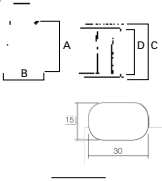

31



crochet pour tablette
gancho para pala

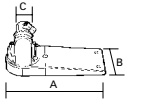

10

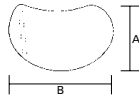

11

31 94-châssis pour chaise en tube ovale 30x15 avec accoudoirs pour tablette
94-estructura para silla tubular oval 30x15 con brazos para pala

code	finishing	q.kit	q.pack	a	b	c	d	kg.x1	vol.x1
112003-022	● noir/negro	x1	80	450	470	545	425	3,80	mc. 0.042
112004-022	● gris/gris	x1	80	450	470	545	425	3,80	mc. 0.042
112010-043	● chromé/cromado	x1	80	450	470	545	425	3,80	mc. 0.042

10 spt2-rotule pour tablette en thermoplastique
spt2-articulación para pala de termoplástico

code	finishing	q.kit	q.pack	a	b	c	kg.x1	vol.x1
134003-039	● noir/negro	x1	20	180	66	15x15	0,35	mc. 0.0006

11 bean-tablette en thermoplastique ovale épaisseur 16 mm
bean-pala de material termoplástico oval grosor 16 mm

code	finishing	q.kit	q.pack	a	b	kg.x1	vol.x1
134003-044	● noir/negro	x1	20	235	370	0,40	mc. 0.002

TLT tablet TLT2 tablet TLT3 tablet BEAN tablet TL02 tablet SPT2 mechanism tablet SPTA mechanism antipanic



for writing tablet options, see page 404/405

4-legs with armrests/backrest and seat options

main component sizes

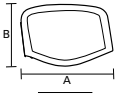

15

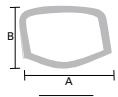

16

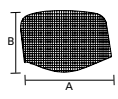

17



15 isonet-châssis dossier en plastique avec vis pour treillis
isonet-estructura respaldo de plástico con tornillos para malla

code	finishing	q.kit	q.pack	a	b	kg.x1	vol.x1
132103-003	● noir/negro	x1	25	470	345	0,42	mc. 0.006

16 isonet-cadre dossier en plastique pour treillis
isonet-marco respaldo de plástico para malla

code	finishing	q.kit	q.pack	a	b	kg.x1	vol.x1
132103-004	● noir/negro	x1	25	470	345	0,31	mc. 0.004

17 isonet-trellis pour dossier
isonet-malla para respaldo

code	finishing	q.kit	q.pack	a	b	kg.x1	vol.x1
132105-500	○ blanc/blanco	x1	25	550	400	0,14	mc. 0.0057
132103-500	● noir/negro	x1	25	550	400	0,14	mc. 0.0057
132102-500	● rouge/rojo	x1	25	550	400	0,14	mc. 0.0057

and · **05 06 07 32**

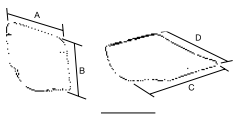

18



18 novx-siège et dossier en plastique pour châssis en tube ovale et en tube elliptique
novx-asiento y respaldo de plástico disponibles para estructura tubular ovale et tubular elliptique

code	finishing	q.kit	q.pack	a	b	c	d	kg.x1	vol.x1
134002-001	● rouge/rojo	x1	20	470	315	460	400	1,21	mc. 0.008
134003-119	● noir/negro	x1	20	470	315	460	400	1,21	mc. 0.008
134015-003	● bleu/azul	x1	20	470	315	460	400	1,21	mc. 0.008

and · **07**

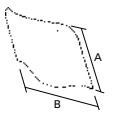

03



03 goshi-dossier interne en plastique
goshi-respaldo interno de plástico

code	finishing	q.kit	q.pack	a	b	kg.x1	vol.x1
132103-002	● noir/negro	x1	40	330	470	0,60	mc. 0.004

04 goshe-couvre-dossier externe en plastique
goshe-respaldo externo de plástico

code	finishing	q.kit	q.pack	a	b	kg.x1	vol.x1
132103-001	● noir/negro	x1	30	475	335	0,40	mc. 0.004

and · **05 06 31 32**

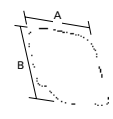

04

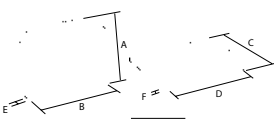

21



21 goshsdif-dossier + siège multicouches verni hêtre + 4 embouts
goshsdif-respaldo + asiento contrachapado pintado haya + 4 terminales

code	finishing	q.kit	q.pack	a	b	c	d	e	f	kg.x1	vol.x1
124007-000	● hêtre/haya	x1	10	325	465	415	460	10	10	2,70	mc. 0.07

and · **07**

90 slide

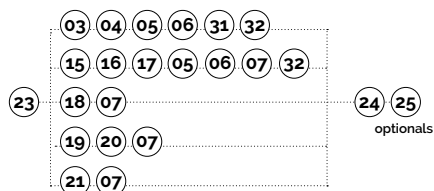
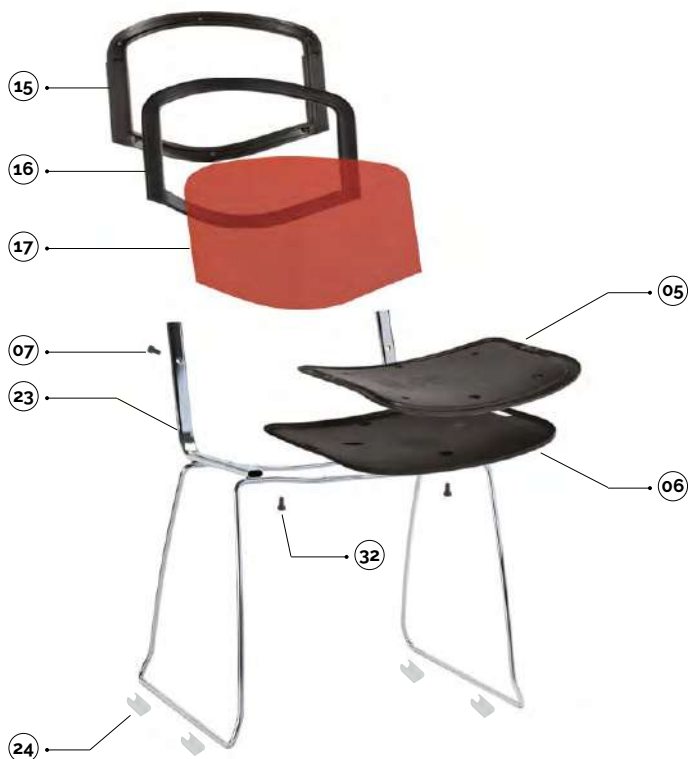

main component sizes

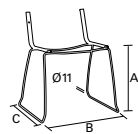

23

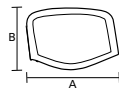

15

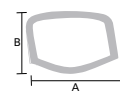

16

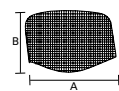

17

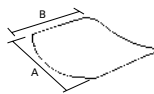

05

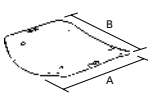

06



24



25

optionals

23 spritz-châssis ferme tige ø11 embouts exclus spritz-estructura cerrada de varilla d.11 tapones excluidos

code	finishing	q.kit	q.pack	a	b	c	kg.x1	vol.x1
112010-250	● chromé/cromado	x1	100	450	580	470	4,00	mc. 0,042

24 pack de bases à pince anti-rotation pour tige couleur neutre paquete de bases con pinza antirotación para varilla de color neutro

code	finishing	q.kit	q.pack
137006-070	○ neutre/neutro	x4	200

25 base plate à pince double en pe pour élément de jonction chaises base plana con pinza doble de pe para varilla para unión sillas

code	finishing	q.kit
134006-021	○ neutre/neutro	x4

15 isonet-châssis dossier en plastique avec vis pour treillis isonet-malla respaldo de plástico con tornillos para malla

code	finishing	q.kit	q.pack	a	b	kg.x1	vol.x1
132103-003	● noir/negro	x1	25	470	345	0,42	mc. 0,006

16 isonet-cadre dossier en plastique pour treillis isonet-marco respaldo de plástico para malla

code	finishing	q.kit	q.pack	a	b	kg.x1	vol.x1
132103-004	● noir/negro	x1	25	470	345	0,31	mc. 0,004

17 isonet-treillis pour dossier isonet-malla para respaldo

code	finishing	q.kit	q.pack	a	b	kg.x1	vol.x1
132105-500	○ blanc/blanco	x1	25	550	400	0,14	mc. 0,0057
132103-500	● noir/negro	x1	25	550	400	0,14	mc. 0,0057
132102-500	● rouge/rojo	x1	25	550	400	0,14	mc. 0,0057

05 gosdi-assise interne en plastique gosdi-asiento interno de plástico

code	finishing	q.kit	q.pack	a	b	kg.x1	vol.x1
132203-002	● noir/negro	x1	30	460	400	0,80	mc. 0,004

06 gosde-assise externe en plastique gosde-asiento externo de plástico

code	finishing	q.kit	q.pack	a	b	kg.x1	vol.x1
132203-001	● noir/negro	x1	80	410	465	0,40	mc. 0,003

07 vis tête évasée croix m6x18 brunie noire-fixation siège/ dossier hêtre tornillo cabeza avellanada en cruz m6x18 bruñido negro - fijación asiento / respaldo haya

code	finishing	q.kit
117703-195	● noir/negro	x4

32 vis tsp+ m6x25 zinguée blanche tornillo tsp+ m6x25 galvanizada blanca

code	finishing	q.kit
117711-199	● zinguée blanc/galvanizado blanco	x2

90

slide/backrest and seat options

main component sizes

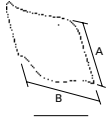

03

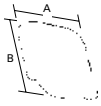

04



03 goshi-dossier interne en plastique
goshi-respaldo interno de plástico

code	finishing	q.kit	q.pack	a	b	kg.x1	vol.x1
132103-002	● noir/negro	x1	40	330	470	0.60	mc. 0.004

04 goshe-couvre-dossier externe en plastique
goshe-respaldo externo de plástico

code	finishing	q.kit	q.pack	a	b	kg.x1	vol.x1
132103-001	● noir/negro	x1	30	475	335	0.40	mc. 0.004

and · **05** **06** **31** **32**

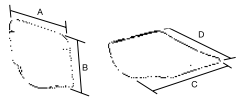

18



18 novx-siège et dossier en plastique pour châssis en tube ovale et en tube elliptique
novx-asiento y respaldo de plástico disponibles para estructura tubular ovale y tubular elliptique

code	finishing	q.kit	q.pack	a	b	c	d	kg.x1	vol.x1
134002-001	● rouge/rojo ral3002	x1	20	470	315	460	400	1.21	mc. 0.008
134003-119	● noir/negro ral9005	x1	20	470	315	460	400	1.21	mc. 0.008
134015-003	● bleu/azul ral5002	x1	20	470	315	460	400	1.21	mc. 0.008

and · **07**

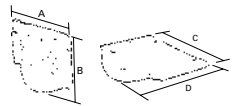

19



19 prisma-siège et dossier en plastique pour châssis en tube ovale et en tube elliptique
prisma-asiento y respaldo de plástico disponibles para estructura tubular ovale y tubular elliptique

code	finishing	q.kit	q.pack	a	b	c	d	kg.x1	vol.x1
134003-110	● noir/negro	x1	10	470	330	460	430	1.60	mc. 0.016

20 prisma-panneau assise pour tapisserie
prisma-panel asiento para tapizar

code	finishing	q.kit	q.pack	a	b	kg.x1	vol.x1
132203-010	● noir/negro	x1	20	400	400	0.40	mc. 0.004

and · **07**

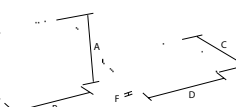

21



21 goshsdlf-dossier + siège multicouches verni hêtre + 4 embouts
goshsdlf-respaldo + asiento contrachapado pintado haya + 4 terminales

code	finishing	q.kit	q.pack	a	b	c	d	e	f	kg.x1	vol.x1
124007-000	● hêtre/haya	x1	10	325	465	415	460	10	10	2.70	mc. 0.07

and · **07**

90 swivel

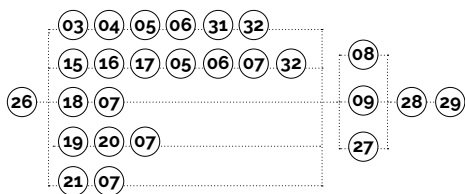

main component sizes

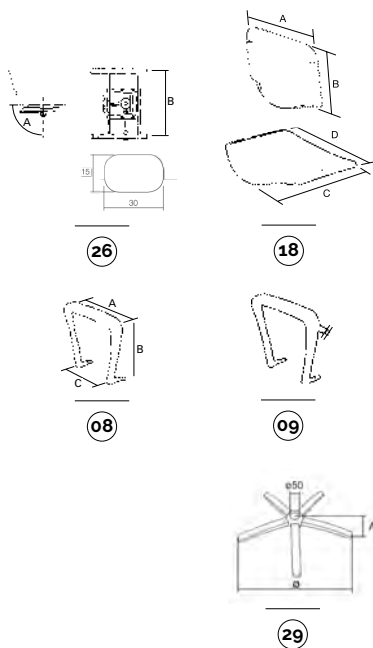

26 g2gy-châssis pour chaise pivotant en tube ovale 30x15 avec plaque de commande au gaz, avec spatule, sans embouts
g2gy-estructura para silla giratoria tubular oval 30x15 con placa de accionamiento con mecanismo de gas con palanca, tapones excluidos

code	finishing	arm attach	q.kit	q.pack	a	b	kg.x1	vol.x1
112003-200	● noir/negro	14	x1	200	87"	425	2.62	mc. 0.015
112003-201	● noir/negro	12	x1	200	87"	425	2.62	mc. 0.015
112010-200	● chromé/cromado	14	x1	200	87"	425	2.62	mc. 0.015
112010-201	● chromé/cromado	12	x1	200	87"	425	2.62	mc. 0.015

18 novx-siège et dossier en plastique pour châssis en tube ovale et en tube elliptique
novx-asiento y respaldo de plástico disponibles para estructura tubular oval y tubular elíptico

code	finishing	q.kit	q.pack	a	b	c	d	kg.x1	vol.x1
134002-001	● rouge/rojo	ral3002	x1	20	470	315	460 400	1.21	mc. 0.008
134003-119	● noir/negro	ral9005	x1	20	470	315	460 400	1.21	mc. 0.008
134015-003	● bleu/azul	ral5002	x1	20	470	315	460 400	1.21	mc. 0.008

08 gob-accoudeur en nylon
gob-brazo de nailon

code	finishing	arm attach	q.kit	q.pack	a	b	c	kg.x1	vol.x1
131703-002	● noir/negro	14	x2	20	290	250	190	0.80	mc. 0.0026
131703-004	● noir/negro	12	x2	20	290	250	190	0.80	mc. 0.0026

09 gobp-accoudeur en nylon avec attelage porte tablette
gobp-brazo de nailon con enganche para pala

code	finishing	arm attach	q.kit	q.pack	a	b	c	d	kg.x1	vol.x1
131703-001	● noir/negro	14	x1	20	290	250	190	15x15	0.80	mc. 0.0026
131703-003	● noir/negro	12	x1	20	290	250	190	15x15	0.80	mc. 0.0026

07 vis tête évasée croix m6x18 brunie noire-fixation siège/ dossier hêtre
tornillo cabeza avellanada en cruz m6x18 bruñido negro - fijación asiento / respaldo haya

code	finishing	q.kit
117703-195	● noir/negro	x4

27 pack embouts couvre-tête ø18 noir
paquete de tapones embellecedores d.18 negro

code	finishing	diameter	q.kit	q.pack
137003-070	● noir/negro	ø18	x4	200
134103-151	● noir/negro	ø15	x4	

28 pack embouts couvre-tête ovales 30x15 noirs
paquete de tapones embellecedores ovales 30x15 negros

code	finishing	q.kit	q.pack
137003-071	● noir/negro	x4	200

29 b40-base en métal avec cache-soudure
b40-base de metal con embellecedor soldadura

code	finishing	q.kit	q.pack	a	ø	kg.x1	vol.x1
110210-027	● chromé/cromado	x1	5	60	640	2.85	mc. 0.014

90

swivel/backrest and seat options

main component sizes

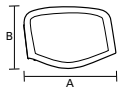

15

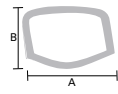

16

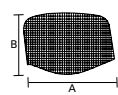

17



15 isonet-châssis dossier en plastique avec vis pour treillis
isonet-estructura respaldo de plástico con tornillos para malla

code	finishing	q.kit	q.pack	a	b	kg.x1	vol.x1
132103-003	● noir/negro	x1	25	470	345	0,42	mc. 0,006

16 isonet-cadre dossier en plastique pour treillis
isonet-marco respaldo de plástico para malla

code	finishing	q.kit	q.pack	a	b	kg.x1	vol.x1
132103-004	● noir/negro	x1	25	470	345	0,31	mc. 0,004

17 isonet-treillis pour dossier
isonet-malla para respaldo

code	finishing	q.kit	q.pack	a	b	kg.x1	vol.x1
132105-500	○ blanc/blanco	x1	25	550	400	0,14	mc. 0,0057
132103-500	● noir/negro	x1	25	550	400	0,14	mc. 0,0057
132102-500	● rouge/rojo	x1	25	550	400	0,14	mc. 0,0057

and · **05** **06** **07** **32**



03

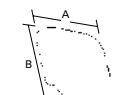

04



03 gosshi-dossier interne en plastique
gosshi-respaldo interno de plástico

code	finishing	q.kit	q.pack	a	b	kg.x1	vol.x1
132103-002	● noir/negro	x1	40	330	470	0,60	mc. 0,004

04 goshe-couvre-dossier externe en plastique
goshe-respaldo externo de plástico

code	finishing	q.kit	q.pack	a	b	kg.x1	vol.x1
132103-001	● noir/negro	x1	30	475	335	0,40	mc. 0,004

and · **05** **06** **31** **32**



19

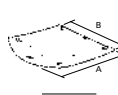

20



19 prisma-siège et dossier en plastique pour châssis en tube ovale et en tube elliptique
prisma-asiento y respaldo de plástico disponibles para estructura tubular oval y tubular elíptico

code	finishing	q.kit	q.pack	a	b	c	d	kg.x1	vol.x1
134003-110	● noir/negro	x1	10	470	330	460	430	1,60	mc. 0,016

20 prisma-panneau assise pour tapisserie
prisma-panel asiento para tapizar

code	finishing	q.kit	q.pack	a	b	kg.x1	vol.x1
132203-010	● noir/negro	x1	20	400	400	0,40	mc. 0,004

and · **07**

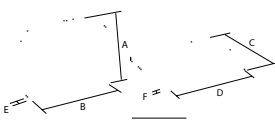

21



21 goshsdlf-dossier + siège multicouches verni hêtre + 4 embouts
goshsdlf-respaldo + asiento contrachapado pintado haya + 4 terminales

code	finishing	q.kit	q.pack	a	b	c	d	e	f	kg.x1	vol.x1
124007-000	● hêtre/haya	x1	10	325	465	415	460	10	10	2,70	mc. 0,07

and · **07**

90 bench



CERTIFIED BY
CATAS

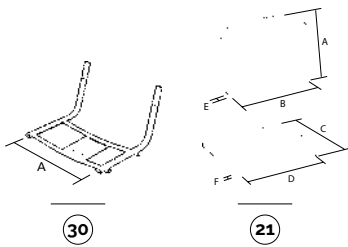
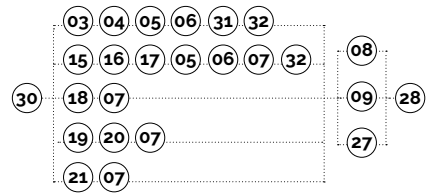

30 92pv-châssis en tube ovale ou elliptique pour banquette vernie
92pv-estructura tubular oval o eliptica para bancada pintada

code	finishing	arm attach	q.kit	q.pack	a	kg.x1	vol.x1
110703-061	● noir/negro	12 ovale/oval	x1	200	425	2,20	mc. 0.015
110703-062	● noir/negro	14 ovale/oval	x1	200	425	2,20	mc. 0.015

21 90shsdlf-dossier + siège multicouches verni hêtre + 4 embouts
90shsdlf-respaldo + asiento contrachapado pintado haya + 4 terminales

code	finishing	q.kit	q.pack	a	b	c	d	e	f	kg.x1	vol.x1
124007-000	● hêtre/haya	x1	10	325	465	415	460	10	10	2,70	mc. 0.07

07 vis tête évasée croix m6x18 brunie noire-fixation siège/ dossier hêtre
tornillo cabeza avellanada en cruz m6x18 bruñido negro - fijación asiento / respaldo haya

code	finishing	q.kit
117703-195	● noir/negro	x4

27 pack embouts couvre-tête ø18 noir
paquete de tapones embellecedores d.18 negro

code	finishing	diameter	q.kit	q.pack
137003-070	● noir/negro	ø18	x4	200
134103-151	● noir/negro	ø15	x4	

28 pack embouts couvre-tête ovales 30x15 noirs
paquete de tapones embellecedores ovales 30x15 negros

code	finishing	q.kit	q.pack
137003-071	● noir/negro	x4	200

for the bench components, see page 417

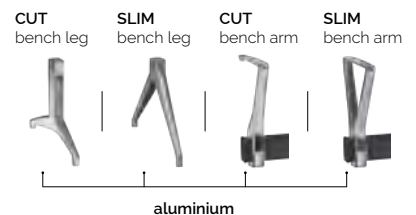
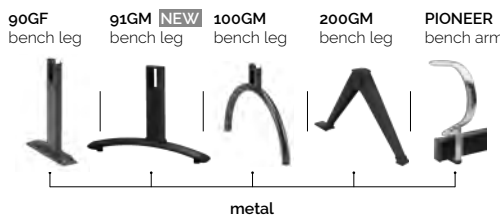

main component sizes

optionals





stelo



discover more about
Stelo Collection

La collection de porte-manteaux Stelo se distingue par son design épuré de tête pivotante et son esthétique globale essentielle.

Stelo est extrêmement fonctionnel, grâce au simple système d'assemblage par emboîtement des différents éléments, et se monte et se démonte rapidement.

Le cadre en métal est disponible en 4 finitions et peut être combiné avec les éléments en plastique proposés en 3 couleurs.

La colección de percheros Stelo se destaca por su diseño limpio de cabeza giratoria y su estética esencial.

Stelo es extremadamente funcional y rápido de montar y desmontar, gracias al sencillo sistema de encaje de los distintos elementos.

La estructura metálica está disponible en 4 acabados y se puede combinar con los elementos de plástico ofrecidos en 3 colores.

Plus

- Système d'assemblage par emboîtement.
- Tubes en métal de 40 mm disponibles en 4 couleurs différentes.
- Éléments en plastique disponibles en 3 couleurs différentes.
- Tête pivotante pratique et porte-parapluies confortable.
- Sistema de ensamblaje por encaje.
- Tubos metálicos de 40 mm disponibles en 4 colores diferentes.
- Elementos de plástico disponibles en 3 colores diferentes.
- Práctica cabeza giratoria y cómodo paraguero.



designed by:
Shannon Sadler

stelo

components

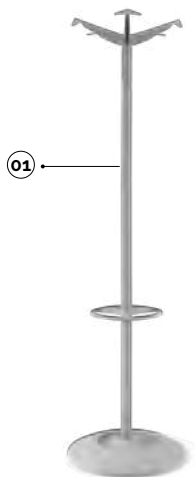
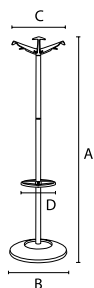

01 stelo - porte-manteaux a colonne avec porte-parapluies
stelo - perchero de columna con paraguero

code	metal finishing	plastic finishing	q.kit	q.pack	a	ø b	ø c	ø d	kg.x1	vol.x1
110403-189	● noir/negro	● noir/negro	x1	48	1720	470	441	282	4,3	mc. 0.05
110404-189	● gris/gris	● noir/negro	x1	48	1720	470	441	282	4,3	mc. 0.05
110404-190	● gris/gris	● gris/gris	x1	48	1720	470	441	282	4,3	mc. 0.05
110405-189	○ blanc/blanco	● noir/negro	x1	48	1720	470	441	282	4,3	mc. 0.05
110405-190	○ blanc/blanco	○ blanc/blanco	x1	48	1720	470	441	282	4,3	mc. 0.05
110410-189	● chromé/cromado	● noir/negro	x1	48	1720	470	441	282	4,3	mc. 0.05
110410-190	● chromé/cromado	● gris/gris	x1	48	1720	470	441	282	4,3	mc. 0.05

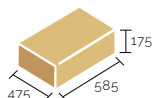

1 kit
per colour

choose the finish that best suits your environment





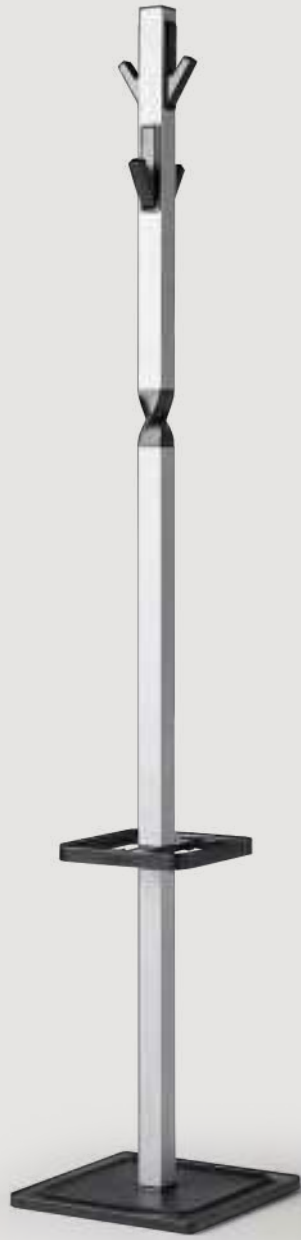

space



discover more about
Space Collection

Style et fonctionnalité.

Space est un complément d'ameublement de design minimaliste et sophistiqué. Ses crochets cachés coordonnés aux éventuelles finitions de la colonne en métal carrée, seront la tendance du futur.

Sa stabilité parfaite, grâce à une base en métal, et sa facilité d'utilisation, font de ce complément d'ameublement un élément absolument indispensable.

Space est parfait pour les bureaux, les milieux professionnels et domestiques.

Estilo y funcionalidad.

Space es el complemento de decoración, caracterizado por un diseño minimalista y refinado. Sus enganches escamoteables, combinados con los posibles acabados de la columna en metal cuadrada, serán la tendencia del futuro.

Es un elemento de decoración absolutamente imprescindible por su perfecta estabilidad, con su base de metal, y por la comodidad de utilización.

Space es ideal para los ambientes oficina, contract y la casa.

Plus

- Des crochets cachés et un design avec une colonne carrée.
- Un porte-parapluie.
- 3 couleurs disponibles.
- Des dimensions d'emballage très compactes.
- Enganches escamoteables y diseño con sección cuadrada de la columna.
- Paragüero práctico.
- 3 colores disponibles.
- Dimensiones muy compactas de embalaje.



designed by:
Stefano Bettio

space

components

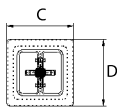
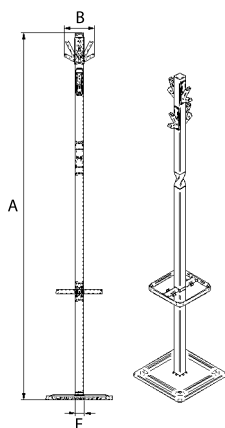

01

main component sizes

01 space-porte-manteaux à colonnes en tube carré avec porte-parapluies et éléments en plastique
space-perchero en columna tubular cuadrado con paraguero y componentes de plástico

code	finishing	plastic	q.kit	q.pack	a	b	c	d	e	kg.x1	vol.x1
110403-170	● noir/negro	● noir/negro	x1	60	1750	145	320	320	40x40	7,60	mc. 0.032
110404-170	● gris/gris	● noir/negro	x1	60	1750	145	320	320	40x40	7,60	mc. 0.032
110405-170	○ blanc/blanco	● noir/negro	x1	60	1750	145	320	320	40x40	7,60	mc. 0.032

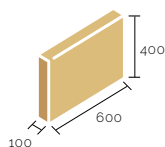





coat hangers



discover more about
Coat hangers Collection

Une grande fonctionnalité associée à un design toujours caractéristique permettent de rendre chaque proposition de porte-manteaux Alba remarquable.

La grande qualité des matériaux utilisés et une recherche attentive de finitions appropriées et de couleurs de plastique associées au métal, permettent d'offrir bien plus que de simples compléments, de véritables solutions d'aménagement pour différents environnements, souvent enrichis par des accessoires tels que le porte-parapluie et/ou le plateau porte-objets, qui assurent une fonctionnalité maximale et une utilisation pratique.

La extrema funcionalidad, que se suma a un diseño también distintivo, convierte cada propuesta de percheros Alba en algo digno de mención.

La calidad elevada de los materiales empleados y la búsqueda meticulosa de los acabados más idóneos y de los colores de los plásticos, combinados con el metal, ofrecen complementos, que son auténticas soluciones decorativas para los varios ambientes y no simples complementos.

Se suelen enriquecer con accesorios, tales como el paraguero y/o la bandeja portaobjetos, para garantizar la máxima funcionalidad y comodidad de utilización.

coat hangers

components

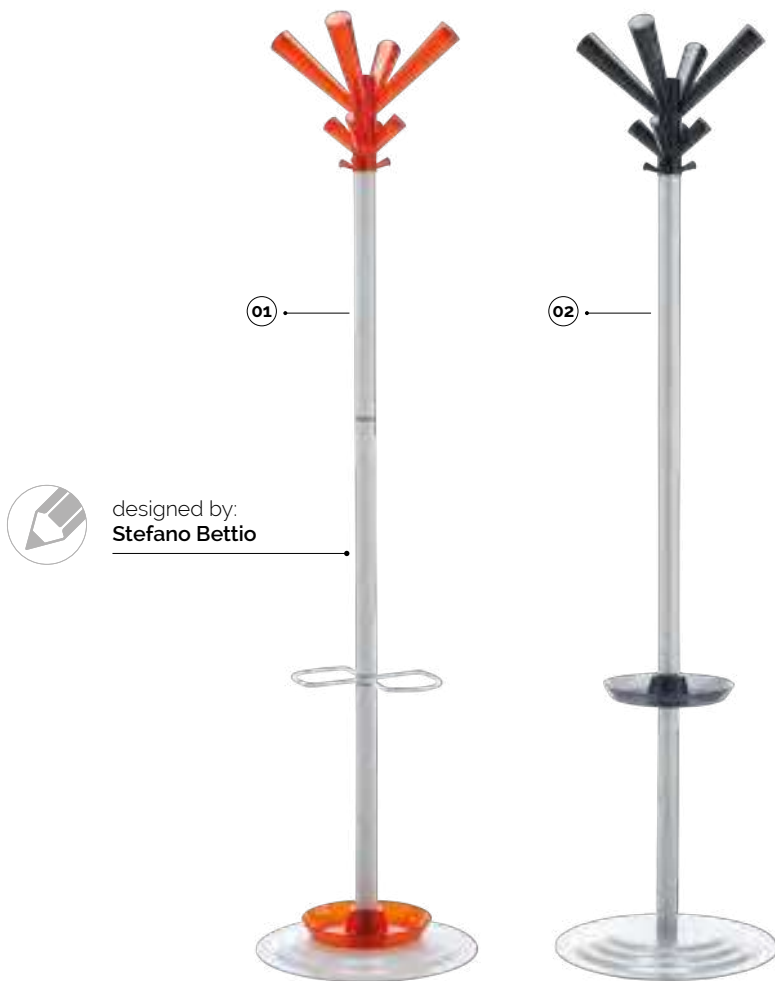

designed by:
Stefano Bettio

main component sizes

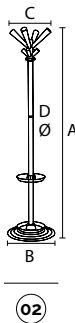
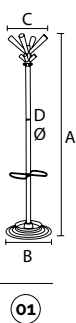

01 joy-porte-manteaux à colonnes avec porte-parapluies, éléments en plastique
joy-perchero en columna con paragüero, componentes de plástico

code	finishing	plastic	q.kit	q.pack	a	b	c	d	kg.x1	vol.x1
110404-100	● gris/gris	○ transparent	x1	60	1750	415	380	40	8,65	mc. 0.039
110404-101	● gris/gris	● orange transparent	x1	60	1750	415	380	40	8,65	mc. 0.039
110404-102	● gris/gris	● fumé transparent	x1	60	1750	415	380	40	8,65	mc. 0.039
110405-100	○ blanc/blanco	○ transparent	x1	60	1750	415	380	40	8,65	mc. 0.039
110405-101	○ blanc/blanco	● orange transparent	x1	60	1750	415	380	40	8,65	mc. 0.039
110405-102	○ blanc/blanco	● fumé transparent	x1	60	1750	415	380	40	8,65	mc. 0.039

02 easy-porte-manteaux à colonnes avec plateau vide-poches, éléments en plastique
easy-perchero en columna con bandeja para objetos, componentes de plástico

code	finishing	plastic	q.kit	q.pack	a	b	c	d	kg.x1	vol.x1
110404-106	● gris/gris	○ transparent	x1	60	1750	415	380	40	8,20	mc. 0.039
110404-107	● gris/gris	● orange transparent	x1	60	1750	415	380	40	8,20	mc. 0.039
110404-108	● gris/gris	● fumé transparent	x1	60	1750	415	380	40	8,20	mc. 0.039
110405-106	○ blanc/blanco	○ transparent	x1	60	1750	415	380	40	8,20	mc. 0.039
110405-107	○ blanc/blanco	● orange transparent	x1	60	1750	415	380	40	8,20	mc. 0.039
110405-108	○ blanc/blanco	● fumé transparent	x1	60	1750	415	380	40	8,20	mc. 0.039

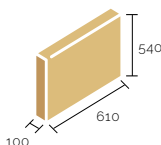
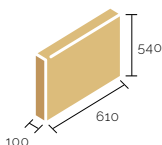

coat hangers

components

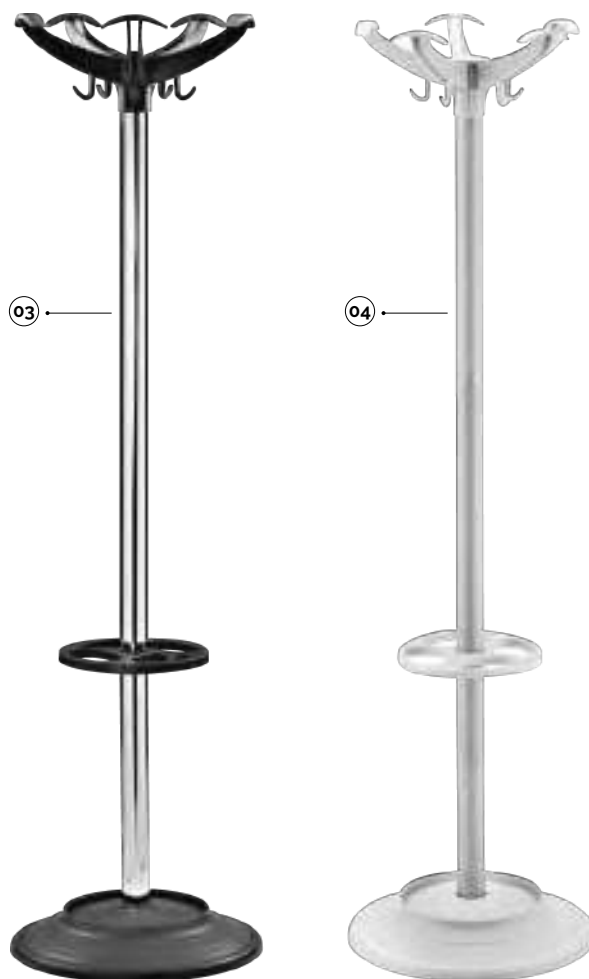

03

04

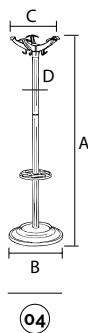
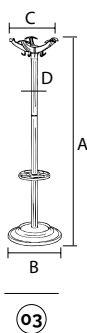

main component sizes

03 elix-porte-manteaux à colonnes avec porte-parapluies, éléments en plastique noirs
elix-perchero en columna con paraguero, componentes de plástico negros

code	finishing	plastic	q.kit	q.pack	a	b	c	d	kg.x1	vol.x1
110403-040	● noir/negro	● noir/negro	x1	60	1730	450	400	50	5,00	mc. 0.045
110404-006	● gris/gris	● noir/negro	x1	60	1730	450	400	50	5,00	mc. 0.045
110405-015	○ blanc/blanco	● noir/negro	x1	60	1730	450	400	50	5,00	mc. 0.045
110410-040	● chromé/cromado	● noir/negro	x1	60	1730	450	400	50	5,00	mc. 0.045

04 elix.g-porte-manteaux à colonnes avec porte-parapluies, éléments en plastique gris
elix.g-perchero en columna con paraguero, componentes de plástico grises

code	finishing	plastic	q.kit	q.pack	a	b	c	d	kg.x1	vol.x1
110404-005	● gris/gris	● gris/gris	x1	60	1730	450	400	50	5,00	mc. 0.045
110410-039	● chromé/cromado	● gris/gris	x1	60	1730	450	400	50	5,00	mc. 0.045

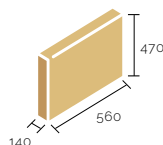
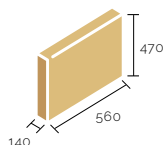

coat hangers

components

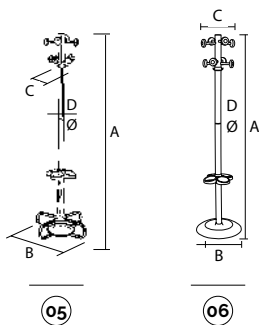

05 bravo-porte-manteaux à colonnes avec porte-parapluies, éléments en plastique noirs
bravo-perchero en columna con paraguero, componentes de plástico negros

code	finishing	plastic	q.kit	q.pack	a	b	c	d	kg.x1	vol.x1
110403-001	● noir/negro	● noir/negro	x1	60	1750	415	380	50	8,20	mc. 0.039
110404-029	● gris/gris	● noir/negro	x1	60	1750	415	380	50	8,20	mc. 0.039
110410-029	● chromé/cromado	● noir/negro	x1	60	1750	415	380	50	8,20	mc. 0.039

06 eco-porte-manteaux à colonnes avec porte-parapluies, éléments en plastique noirs
eco-perchero en columna con paraguero, componentes de plástico negros

code	finishing	plastic	q.kit	q.pack	a	b	c	d	kg.x1	vol.x1
110403-025	● noir/negro	● noir/negro	x1	50	1700	400	330	50	5,00	mc. 0.045
110404-120	● gris/gris	● noir/negro	x1	50	1700	400	330	50	5,00	mc. 0.045
110410-120	● chromé/cromado	● noir/negro	x1	50	1700	400	330	50	5,00	mc. 0.045

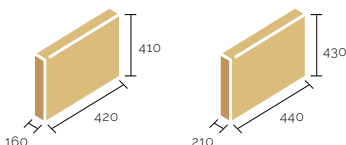

main component sizes

coat hangers

components

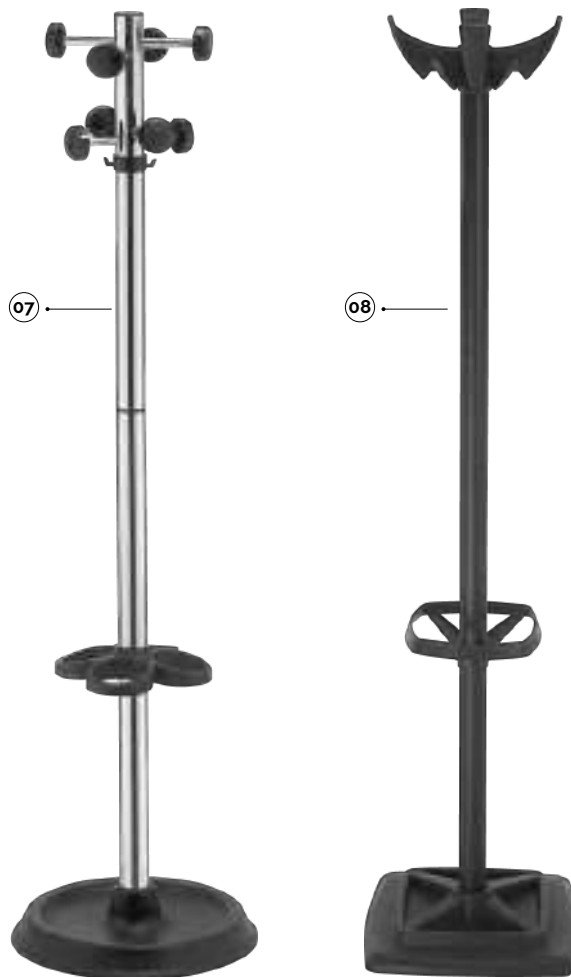

07

08

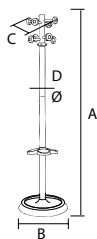

07

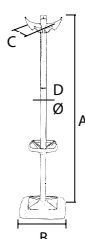

08

07 good-porte-manteaux à colonnes avec porte-parapluies, éléments en plastique noirs
good-perchero en columna con paragüero, componentes de plástico negros

code	finishing	plastic	q.kit	q.pack	a	b	c	d	kg.x1	vol.x1
110403-050	● noir/negro	● noir/negro	x1	50	1720	430	330	50	5,00	mc. 0.045
110404-020	● gris/gris	● noir/negro	x1	50	1720	430	330	50	5,00	mc. 0.045
110410-030	● chromé/cromado	● noir/negro	x1	50	1720	430	330	50	5,00	mc. 0.045

08 tree-porte-manteaux à colonnes avec porte-parapluies, éléments en plastique noirs
tree-perchero en columna con paragüero, componentes de plástico negros

code	finishing	plastic	q.kit	q.pack	a	b	c	d	kg.x1	vol.x1
110403-065	● noir/negro	● noir/negro	x1	50	1730	450	300	50	4,00	mc. 0.05
110404-090	● gris/gris	● noir/negro	x1	50	1730	450	300	50	4,00	mc. 0.05
110410-070	● chromé/cromado	● noir/negro	x1	50	1730	450	300	50	4,00	mc. 0.05

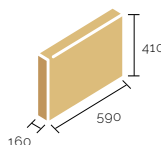
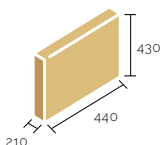

main component sizes



foot rings & columns



discover more about
Components Collection

Une grande variété de matériaux ainsi qu'une qualité certifiée CATAS et BIFMA, permettent d'offrir une large gamme caractéristique de repose-pieds.

Cette ligne a été par ailleurs prévue avec des solutions technologiquement innovantes telles que Gravity, le nouveau système de fermeture d'anneau repose-pieds ayant obtenu un brevet CATAS. Dessiné par un prestigieux cabinet de design, ce système prévoit en effet une fermeture innovante avec un levier assurant une fixation du repose-pieds optimale et plus pratique.

La gran variedad de materiales y la calidad certificada CATAS y BIFMA permiten ofrecer una gama de reposapiés amplia y distintiva.

Asimismo, la línea contempla soluciones tecnológicamente innovadoras, tales como Gravity, el nuevo sistema de cierre del aro reposapiés, que ha obtenido la patente CATAS. Diseñado por un estudio de diseño prestigioso, contempla el cierre innovador mediante una palanca, para garantizar una fijación mejor y más práctica del reposapiés.

foot rings

components

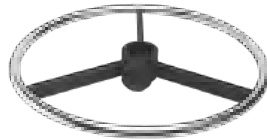
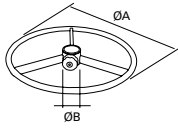

sg50t-anneau repose-pieds télescopique chromé avec volant
sg50t-aro reposapiés telescópico cromado con volante

code	finishing	q.kit	q.pack	øa	øb	kg.x1	vol.x1
110210-008	● chromé/cromado	x1	10	450	50	1.60	mc. 0.008

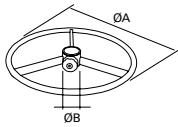

sg51t-anneau repose-pieds télescopique chromé avec volant
sg51t-aro reposapiés telescópico cromado con volante

code	finishing	q.kit	q.pack	øa	øb	kg.x1	vol.x1
110210-081	● chromé/cromado	x1	10	500	50	1.90	mc. 0.008

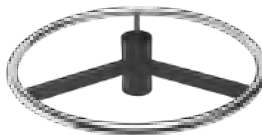
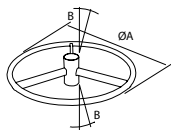

sg50f-anneau repose-pieds chromé
sg50f-aro reposapiés cromado

code	finishing	q.kit	q.pack	øa	øb	kg.x1	vol.x1
110210-005	● chromé/cromado	x1	10	450	1' 26' 16"	1.60	mc. 0.0125



patent



certification

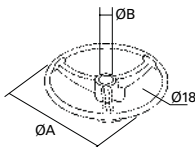

round-anneau repose-pieds télescopique avec volant
round-aro reposapiés telescópico con volante

code	finishing	q.kit	q.pack	øa	øb	kg.x1	vol.x1
110210-009	● chromé/cromado	x1	10	450	50	1.40	mc. 0.0125



patent



certification



designed by:
Esedra

gravity-anneau repose-pieds télescopique chromé avec levier
gravity-aro reposapiés telescópico cromado con palanca

code	finishing	q.kit	q.pack	øa	øb	kg.x1	vol.x1
110210-006	● chromé/cromado	x1	10	450	50	1.10	mc. 0.0125

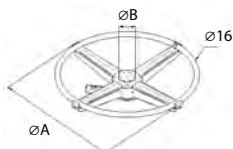

columns

components

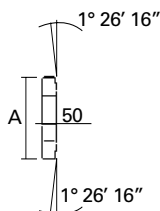

rallonge pour anneau repose-pieds fixe sg50f
extensión para aro reposapiés fijo sg50f

code	finishing	q.kit	q.pack	a	øb	kg.x1	vol.x1
112303-002	● noir/negro	x1	50	130	50	0.24	mc. 0.0031
112310-031	● chromé/cromado	x1	50	130	50	0.24	mc. 0.0031
112303-004	● noir/negro	x1	50	260	50	0.48	mc. 0.0062
112310-030	● chromé/cromado	x1	50	260	50	0.48	mc. 0.0062

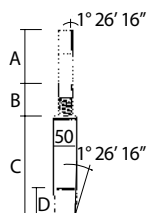

vis de la colonne ø50, h 240
columna elevación tornillo ø50, h 240

code	finishing	q.kit	q.pack	a	b	c	d	kg.x1	vol.x1
112303-053	● noir/negro	x1	30	130	80	240	50	0.81	mc. 0.0190
112310-002	● chromé/cromado	x1	30	130	80	240	50	0.81	mc. 0.0190

— hauteur sur demande
altura bajo pedido

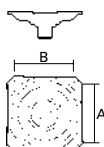
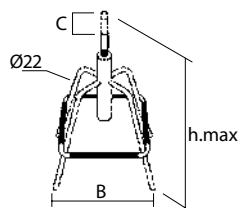
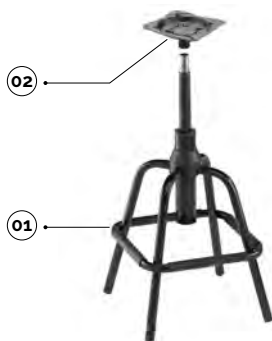

01 sg22-tabourets avec culasse, embouts et accessoires assemblés cône ø21 emballés séparément
sg22-taburetes con tornillo grande, tapones y accesorios ensamblados cono ø21 embalaje individual

code	finishing	q.kit	q.pack	h.max	b	c	kg.x1	vol.x1
110603-035	● noir/negro	x1	1	680	330	130	3.00	mc. 0.053
110610-075	● chromé/cromado	x1	1	680	330	130	3.00	mc. 0.053
110605-002	○ blanc/blanco	x1	1	680	330	130	3.00	mc. 0.053

02 plaque tabouret cône ø21
placa taburete cono ø21

code	finishing	q.kit	q.pack	a	b	kg.x1	vol.x1
113003-100	● noir/negro	x1	20	140	140	0.85	mc. 0.001



slide bases



discover more about
Components Collection

Une base idéale quel que soit votre projet.

Un assortiment de bases Alba offrant un grand nombre de solutions capables de répondre aux exigences les plus disparates en terme de design et d'assurer des standards de qualité élevés

El fundamento ideal para cada uno de tus proyectos.

El surtido de bases Alba ofrece un gran número de soluciones, que responde a las exigencias más variadas, hablando en términos de diseño, y garantiza los estándares más elevados de calidad.

slide bases

components

main component sizes

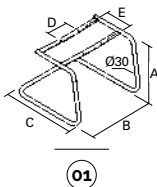

01 sl43-base coulissante tube ø30 embouts exclus
sl43-base patin tubular ø30 tapones excluidos

code	finishing	q.kit	q.pack	a	b	c	d	e	kg.x1	vol.x1
110503-003	● noir/negro	x1	64	400	530	530	155	200	4,70	mc. 0.0313
110504-001	● gris/gris	x1	64	400	530	530	155	200	4,70	mc. 0.0313
110510-020	● chromé/cromado	x1	64	400	530	530	155	200	4,70	mc. 0.0313

02 pack embouts couvre-tête ø30 noir + encliquetages a deux têtions p2p
paquete de tapones embellecedores ø30 negros + pinzas de dos ganchos p2p

code	finishing	q.kit	q.pack
137003-077	● noir/negro	tc30 (x2) - p2p (x6)	tc30 (130 pcs) - p2p (390 pcs)

main component sizes



certification

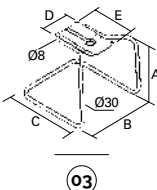

03 sl40-châssis coulissant tige ø25 sans embouts
sl40-estructura patin de varilla d. 25 sin tapones

code	finishing	q.kit	q.pack	a	b	c	d	e	kg.x1	vol.x1
110503-021	● noir/negro	x1	96	430	480	520	170	200	4,10	mc. 0.0313
110504-010	● gris/gris	x1	96	430	480	520	170	200	4,10	mc. 0.0313
110510-002	● chromé/cromado	x1	96	430	480	520	170	200	4,10	mc. 0.0313

04 pack embouts couvre-tête ø25 noirs + encliquetages a deux têtions p2p
paquete de tapones embellecedores ø25 negros + pinzas de dos ganchos p2p

code	finishing	q.kit	q.pack
137003-076	● noir/negro	tc25 (x2) - p2p (x6)	tc25 (195 pcs) - p2p (580 pcs)

05 pied anticapotage en plastique noir
pie antivuelco de plástico negro

code	finishing	q.kit
134303-006	● noir/negro	x2

main component sizes

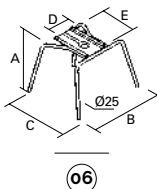

06 rg31-châssis fixe tube ø25 embouts exclus
rg31-estructura fija tubular ø25 tapones excluidos

code	finishing	q.kit	q.pack	a	b	c	d	e	kg.x1	vol.x1
110603-012	● noir/negro	x1	150	430	470	550	170	200	3,70	mc. 0.028
110604-041	● gris/gris	x1	150	430	470	550	170	200	3,70	mc. 0.028
110610-017	● chromé/cromado	x1	150	430	470	550	170	200	3,70	mc. 0.028

07 embout rond ø25 noir
taco redondo ø25 negro

code	finishing	q.kit
134203-253	● noir/negro	x4

slide bases

components

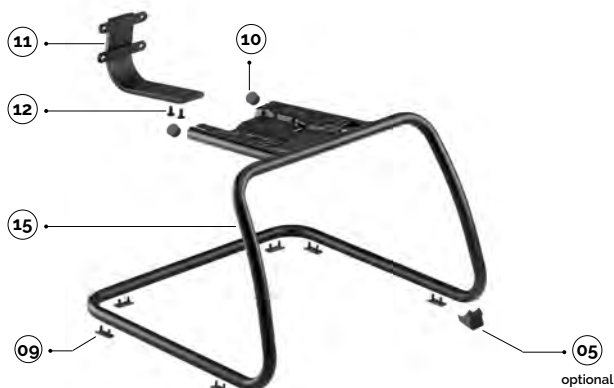

15 sl46-châssis coulissant ø25 sans embouts
sl46-estructura patin tubular d. 25 sin tapones

code	finishing	q.kit	q.pack	a	b	c	kg.x1	vol.x1
110503-007	● noir/negro	x1	64	590	560	400	4,50	mc. 0.032
110504-020	● gris/gris	x1	64	590	560	400	4,50	mc. 0.032
110510-047	● chromé/cromado	x1	64	590	560	400	4,50	mc. 0.032

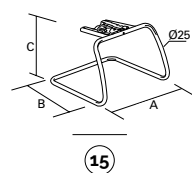

main component sizes

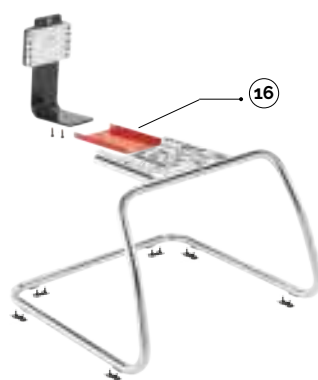

16 plaque adaptateur pour lame dossier
placa adaptadora para hoja respaldo

code	finishing	q.kit	q.pack	kg.x1	vol.x1
113003-150	● noir/negro	x1	30	0,45	mc. 0.001

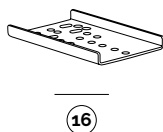

main component sizes



bases



discover more about
Components Collection

Les bases Alba assurent une meilleure prestation sur tout type d'assise, grâce à des standards de réalisation de qualité élevée.

Les composants fondamentaux pour l'appui au sol de chaque coque se distinguent par une grande polyvalence et assurent un assortiment complet, capable de répondre à de multiples exigences en termes de design et de fonctionnalité.

Las bases Alba están realizadas según estándares elevados de calidad para garantizar las mejores prestaciones en todos los tipos de asiento.

Son componentes fundamentales de apoyo en el suelo de cada carcasa, destacan por la máxima versatilidad y garantizan un surtido completo, que responde a las exigencias más variadas, hablando en términos de diseño y de funcionalidad.

bases

components



certification

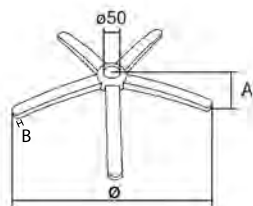

b40-base en métal avec cache-soudure
b40-base de métal con embellecedor soldadura

code	finishing	q.kit	q.pack	ø	a	b	kg.x1	vol.x1
110210-027	● chromé/cromado	x1	5	640	60	11	2,85	mc. 0.014
110210-024	● chromé/cromado	x1	5	700	65	11	3,18	mc. 0.020



certification

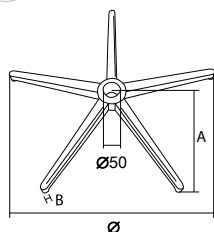

b50-base à 5 branches en métal avec cache-soudure
b50-base de 5 radios de métal con embellecedor soldadura

code	finishing	q.kit	q.pack	ø	a	b	kg.x1	vol.x1
110210-057	● chromé/cromado	x1	5	640	112	11	2,25	mc. 0.0117
110210-058	● chromé/cromado	x1	5	700	118	11	2,50	mc. 0.0126

main component sizes

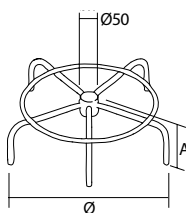
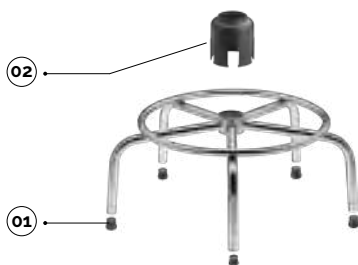

b30-base pour tabouret avec anneau repose-pieds cône ø50 embouts exclus
b30-base para taburete con aro reposapiés cono ø50 tapones excluidos

code	finishing	q.kit	q.pack	ø	a	kg.x1	vol.x1
110210-025	● chromé/cromado	x1	80	540	200	2,55	mc. 0.02

01 embouts ronds ø20 noir
tacos redondos con aletas d.20 negros

code	finishing	q.kit
134203-200	● noir/negro	x5

02 b30/csb-cache-soudure trou ø50 noir
b30/csb-embellecedor soldadura orificio d. 50 negro

code	finishing	q.kit	q.pack	a	b	c	d	e	kg.x1
130203-000	● noir/negro	x1	150	40	20	80	87	50	0,036

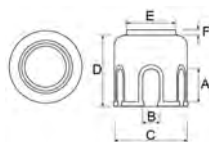





components



discover more about
Components Collection

Une ligne complète de composants et d'accessoires pour le secteur des assises.

Un grand nombre de solutions capables de répondre complètement et de manière fonctionnelle aux exigences les plus disparates : des étriers porte-accoudoirs, des plaques avec un levier pouvant être fournies en option avec un couvercle en plastique pour châssis tournant, un mécanisme pouvant être inversé et des accoudoirs en métal (ou plastique) pour des bancs, des tablettes de différentes formes (en plastique ou en bois) avec des jonctions qui sont également dotées d'un mécanisme anti panique.

Tous les composants et les accessoires Alba assurent un design caractéristique et une technologie innovante, sans oublier les standards de qualité élevés.

Una línea completa de componentes y accesorios para el mundo del asiento.

Un gran número de soluciones, que responde en un modo completo y funcional a las exigencias más diversificadas: soportes para brazos, placas con palanca como opcionales con tapa de plástico para estructura giratoria, mecanismo abatible y brazos de metal (o de plástico) para bancada, palas de varias formas (de plástico o madera), con articulaciones también con mecanismo antipánico.

Todos los componentes y los accesorios Alba garantizan un diseño distintivo y una tecnología innovadora, junto a los estándares más elevados de calidad.

components

components

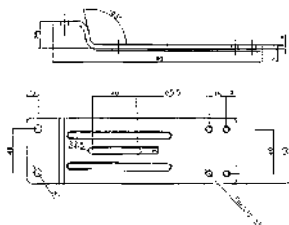

01 sb62-étrier accoudoir
sb62-soporte brazo

code	finishing	q.kit	q.pack	kg.x1	vol.x1
113003-010	● noir/negro	x1	50	0,50	mc. 0.0002

main component sizes

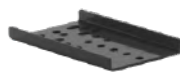
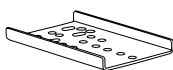

02 plaque adaptateur pour lame dossier
placa adaptadora para hoja respaldo

code	finishing	q.kit	q.pack	kg.x1	vol.x1
113003-150	● noir/negro	x1	30	0,45	mc. 0.001

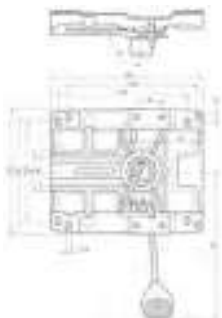

03 plaque au gaz dactylo cône 28 avec levier
placa con mecanismo de gas de ala 28 con palanca

code	finishing	q.kit	q.pack	kg.x1	vol.x1
113003-121	● noir/negro	x1	20	1,23	mc. 0.002

components

components

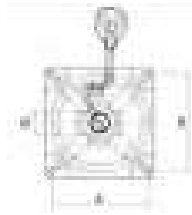

04 pss28nr-plaque tabouret av/levier c/28 3' l4 noire
pss28nr- placa taburete con palanca c/28 3' l4 negra

code	finishing	q.kit	q.pack	a	b	ø	kg.x1	vol.x1
113003-104	● noir/negro	x1	20	150	150	28	1,23	mc. 0,002

main component sizes



designed by:
Stefano Bettio



05 cpg-couverture en plastique pour châssis pivotant
cpg-cubierta de plástico para estructura versión giratoria

code	finishing	q.kit	q.pack	a	b	c	d	ø	kg.x1	vol.x1
130903-000	● noir/negro	x1	50	60	200	210	167	36	0,1	mc. 0,0015

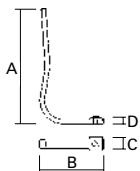
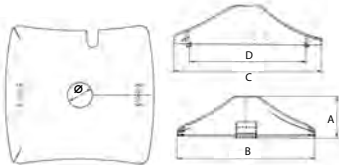

06 sh15-dossier en tube ovale avec cavalier de renforcement taraudé
sh15-respaldo tubular oval con caballete de refuerzo roscado

code	finishing	q.kit	q.pack	a	b	c	d	kg.x1	vol.x1
112103-001	● noir/negro	x1	50	330	215	30	15	0,62	mc. 0,0008

components

components

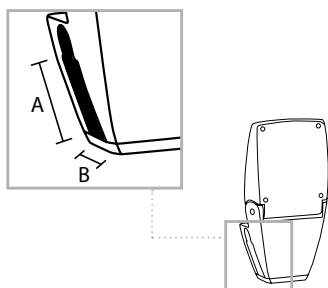

07 siton-mécanisme banquette rabattable en aluminium poli
siton-mecanismo bancada abatible de aluminio brillante

code	finishing	q.kit	q.pack	a	b	kg.x1	vol.x1
110704-180	○ aluminium/aluminio	x1	4	80	40	2,81	mc. 0,007



designed by:
Esedra

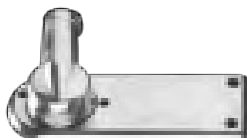

08 spta-rotule tablette anti-panique en aluminium poli
spta-articulación pala antipánico de aluminio brillante

code	finishing		q.kit	q.pack	a	b	c	kg.x1	vol.x1
111701-900	○ aluminium/aluminio	droit/derecha	x1	10	180	66	15x15	0,365	mc. 0,001
111701-901	○ aluminium/aluminio	gauche/izquierda	x1	10	180	66	15x15	0,365	mc. 0,001

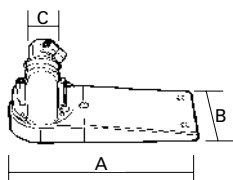

09 spt2-rotule pour tablette en thermoplastique
spt2-articulación para pala de termoplástico

code	finishing	q.kit	q.pack	a	b	c	kg.x1	vol.x1
134003-039	● noir/negro	x1	20	180	66	15x15	0,35	mc. 0,0006

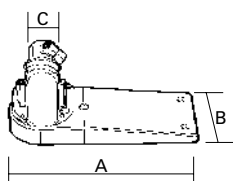

10 isoscele-attelage latéral mâle + femelle en plastique avec deux vis
isoscele-enganche lateral macho + hembra de plástico con dos tornillos

code	finishing	q.kit	q.pack
134003-132	● noir/negro	x2	100

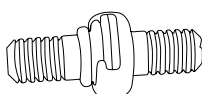

components

components

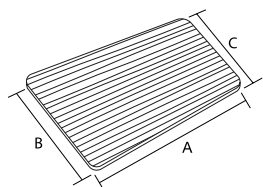

11 tlo2.cfd-tablette vernie en bois de hêtre droite
tlo2.cfd-pala de madera pintada haya derecha

code	finishing	q.kit	q.pack	a	b	c	kg.x1	vol.x1
120307-021	● hêtre/haya	x1	10	342	245	196	0,65	mc. 0,009

tlo2.cfs-tablette vernie en bois de hêtre gauche
tlo2.cfs-pala de madera pintada haya izquierda

code	finishing	q.kit	q.pack	a	b	kg.x1	vol.x1
120307-022	● hêtre/haya	x1	10	342	245	196	0,65 mc. 0,009

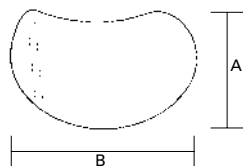

12 bean-tablette en thermoplastique 16 mm
bean-pala de termoplástico 16 mm

code	finishing	q.kit	q.pack	a	b	kg.x1	vol.x1
134003-044	● noir/negro	x1	20	235	370	0,40	mc. 0,002

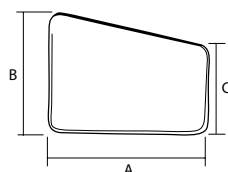

13 tlt-tablette en thermoplastique 16 mm
tlt-pala de termoplástico 16 mm

code	finishing	q.kit	q.pack	a	b	c	kg.x1	vol.x1
134003-042	● noir/negro	x1	20	345	260	200	0,40	mc. 0,002

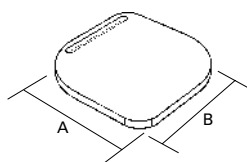

14 tlt2-tablette en thermoplastique ovale épaisseur 16 mm pour accoudoir droit et gauche
tlt2-pala de material termoplástico oval grosor 16 mm para brazo derecho e izquierdo

code	finishing	q.kit	q.pack	a	b	kg.x1	vol.x1
134003-040	● noir/negro	x1	20	271	271	0,40	mc. 0,002

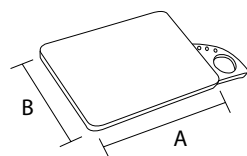

15 tlt3-tablette ambidextre avec porte-verre et porte-stylos
tlt3-pala ambidextro con hueco vasos y lapicero

code	finishing	q.kit	q.pack	a	b	kg.x1	vol.x1
134003-041	● noir/negro	x1	10	370	255	1,05	mc. 0,036



e:usb



discover more about
E:Usb Collection

Une solution fonctionnelle, innovante et design.
Elle a été conçue pour optimiser l'attente dans les aires communes, elle permet aux usagers de recharger un dispositif tout en restant confortablement assis.

E:Usb a été conçue pour toute les aires d'attente.

La solución funcional, innovadora y de diseño.

Diseñada para mejorar la espera en las áreas de comunidad, permite a los usuarios cargar sus dispositivos sentados cómodamente.

E:Usb está pensada para todas las zonas de espera.

Plus

- Elle s'adapte à tout type de modèle de poutre pour banc avec une section de 80X40.
- Elle peut être utilisée par deux dispositifs en même temps.
- Un style minimaliste grâce à sa forme arrondie et à la couleur proposée en noir/gris.
- *Se adapta a todos los modelos de travesaño para bancada con una sección de 80X40.*
- *Se puede utilizar en dos dispositivos al mismo tiempo.*
- *Estilo minimalista con su forma redondeada y su color negro/gris.*

e:usb

components

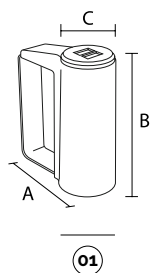

main component sizes

01 e:usb-chargeur pour banquette
e:usb-cargador para bancada

code	finishing	q.kit	q.pack	a	b	c	kg.x1	vol.x1
130703-002	● noir/negro	x1	5	85	100	38	0,28	mc. 0,0009



tu peux charger jusqu'à deux appareils en même temps
puedes cargar hasta dos aparatos al mismo tiempo



e:usb

components



bench components

components



designed by:
R&D Alba

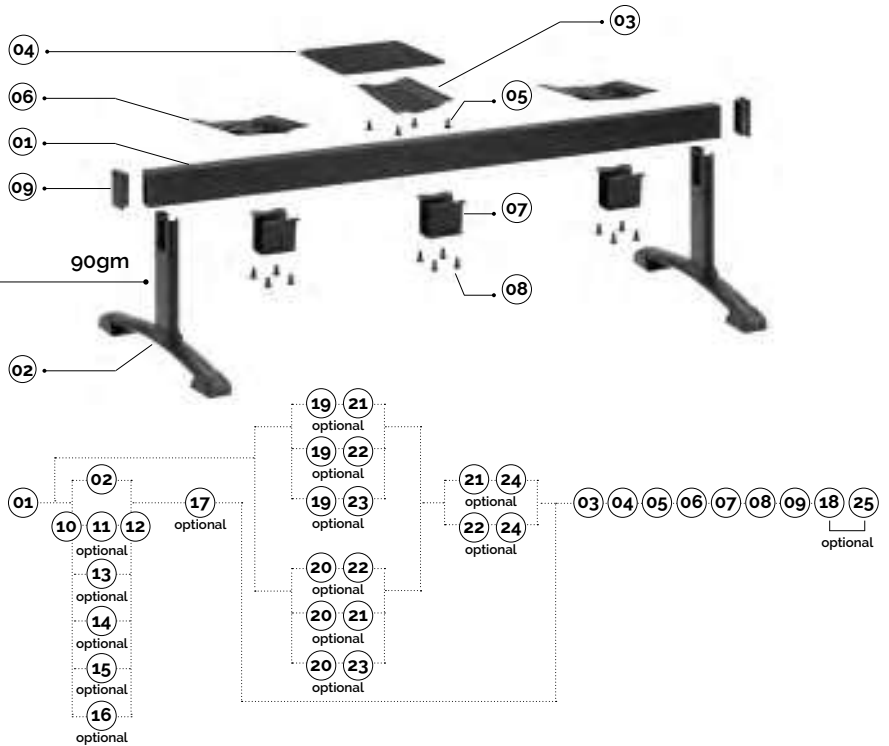

main component sizes

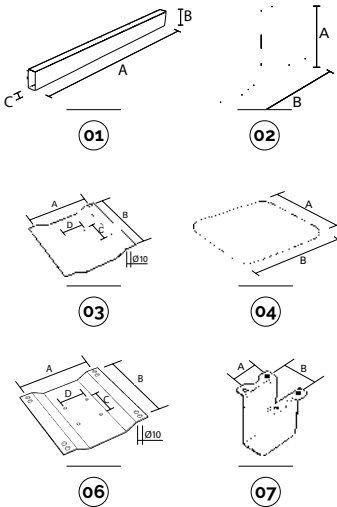

01 90t-poutre pour banquette 90t-viga para bancada

code	finishing		q.kit	q.pack	a	b	c	kg.x1	vol.x1
110703-020	● noir/negro	2 places/2 asientos	x1	1	1000	80	40	2,80	mc. 0,003
110704-043	● gris/gris	2 places/2 asientos	x1	1	1000	80	40	2,80	mc. 0,003
110703-021	● noir/negro	3 places/3 asientos	x1	1	1500	80	40	4,20	mc. 0,0045
110704-044	● gris/gris	3 places/3 asientos	x1	1	1500	80	40	4,20	mc. 0,0045
110703-022	● noir/negro	4 places/4 asientos	x1	1	2000	80	40	5,60	mc. 0,006
110704-045	● gris/gris	4 places/4 asientos	x1	1	2000	80	40	5,60	mc. 0,006
110703-023	● noir/negro	5 places/5 asientos	x1	1	2500	80	40	7,00	mc. 0,0085
110704-046	● gris/gris	5 places/5 asientos	x1	1	2500	80	40	7,00	mc. 0,0085

02 90gm-pied mobile pour banquette avec accessoires 90gm-pata móvil para bancada con accesorios

code	finishing		q.kit	q.pack	a	b	kg.x1	vol.x1
110703-005	● noir/negro		x2	2	380	600	2,70	mc. 0,012
110704-001	● gris/gris		x2	2	380	600	2,70	mc. 0,012
110710-001	● chromé/cromado		x2	2	380	600	2,70	mc. 0,012

03 90ap-raccordement porte plateau 90ap-enganche soporte mesa

code	finishing		q.kit	q.pack	a	b	c	d	kg.x1	vol.x1
110703-014	● noir/negro		x1	25	170	200	65	55	1,00	mc. 0,0002
110704-019	● gris/gris		x1	25	170	200	65	55	1,00	mc. 0,0002

04 90tn-plateau de table pour banquette 90tn-mesa para bancada

code	finishing		q.kit	q.pack	a	b	kg.x1	vol.x1
120303-001	● noir/negro		x1	10	400	400	2,20	mc. 0,002

05 vis tc + m6x12 brunie noire tornillo tc + m6x12 bruñido negro

code	finishing		q.kit
117703-177	● noir/negro		x4

06 92p-plaquette pour banquette vernie 92p-placa para bancada pintada

code	finishing		q.kit	q.pack	a	b	c	d	kg.x1	vol.x1
110703-013	● noir/negro		x1	20	153	200	65	55	0,85	mc. 0,0008

07 90cv-cavalier pour dessous poutre 90cv-caballette bajo viga

code	finishing		q.kit	q.pack	a	b	kg.x1	vol.x1
110703-007	● noir/negro		x1	50	55	65	0,60	mc. 0,0005
110704-015	● gris/gris		x1	50	55	65	0,60	mc. 0,0005

08 pack vis m8x12 tête cylindrique hexagonale encaissée brunie noire paquete de tornillos m8x12 cabeza cilíndrica hexagonal embutida bruñido negro

code	finishing		q.kit	q.pack
117003-070	● noir/negro		x4	200

09 embout couvre-tête rectangulaire 80x40 noir tapón embellecedor rectangular 80 x 40 negro

code	finishing		q.kit
134103-001	● noir/negro		x2

bench leg & arm options

components

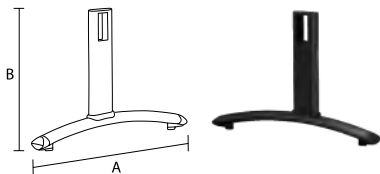

16 91gm-pied mobile pour banquette avec accessoires
91gm-pata móvil para bancada con accesorios

code	finishing	q.kit	q.pack	a	b	kg.x1	vol.x1
110703-581	● noir/negro	x2	2	620	376	2,7	mc. 0,03
110704-581	● gris/gris IG2621	x2	2	620	376	2,7	mc. 0,03
110704-582	● gris/gris drylac	x2	2	620	376	2,7	mc. 0,03
110705-581	○ blanc/blanco ral 9010	x2	2	620	376	2,7	mc. 0,03
110710-581	● chromé/cromado	x2	2	620	376	2,7	mc. 0,03

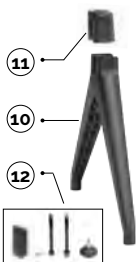
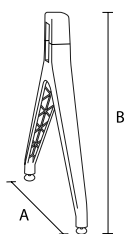

10 jim-pied en plastique noir
jim-pata de plástico negra



Jim / certified product

code	finishing	q.kit	q.pack	a	b	kg.x1	vol.x1
130703-004	● noir/negro	x2	10	630	425	0,95	mc. 0,0102

11 jim-cavalier d'assemblage pour pied noir en plastique
jim-cabalete para fijación pata en plástico negro

code	finishing	q.kit	q.pack	kg.x1	vol.x1
130703-005	● noir/negro	x2	10	0,16	mc. 0,0005

12 jim-kit accessoires pour 10 pieds
jim-kit de accesorios para 10 patas

code	finishing	q.kit	q.pack	kg.x1	vol.x1
130703-007	● noir/negro	x0.2	1	0,15	mc. 0,0004

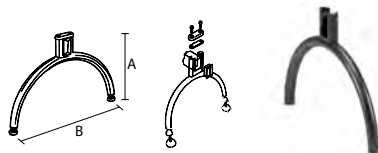

13 100gm-pied mobile pour banquette avec accessoires
100gm-pata móvil para bancada con accesorios

code	finishing	q.kit	q.pack	a	b	kg.x1	vol.x1
110703-008	● noir/negro	x2	2	380	600	2,10	mc. 0,012
110704-006	● gris/gris	x2	2	380	600	2,10	mc. 0,012
110710-005	● chromé/cromado	x2	2	380	600	2,10	mc. 0,012

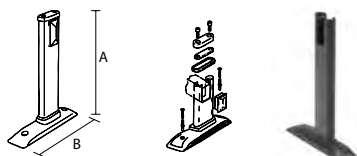

14 90gf-pied fixe pour banquette avec accessoires
90gf-pata fija para bancada con accesorios

code	finishing	q.kit	q.pack	a	b	kg.x1	vol.x1
110703-030	● noir/negro	x2	2	380	310	1,90	mc. 0,012
110704-012	● gris/gris	x2	2	380	310	1,90	mc. 0,012

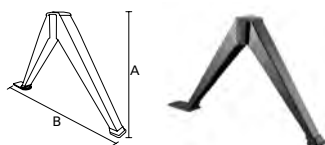

15 200gm-pied mobile pour banquette avec accessoires
200gm-pata móvil para bancada con accesorios

code	finishing	q.kit	q.pack	a	b	kg.x1	vol.x1
110703-110	● noir/negro	x2	4	380	600	2,60	mc. 0,005
110704-110	● gris/gris	x2	4	380	600	2,60	mc. 0,005
110710-110	● chromé/cromado	x2	4	380	600	2,60	mc. 0,005

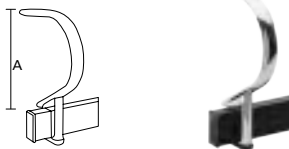

17 pioneer-accoudoir elliptique 40x20 pour banquette avec accessoires
pioneer-brazo elíptico 40x20 para bancada con accesorios

code	finishing	q.kit	q.pack	a	kg.x1	vol.x1
111703-015	● noir/negro	x1	5	260	1,10	mc. 0,005
111704-015	● gris/gris	x1	5	260	1,10	mc. 0,005
111710-015	● chromé/cromado	x1	5	260	1,10	mc. 0,005



18 liaison poutre banquette
empalme viga bancada

code	finishing	q.kit	q.pack	a	b	b	kg.x1
110703-025	● noir/negro	x1	10	75	36	400	1,42

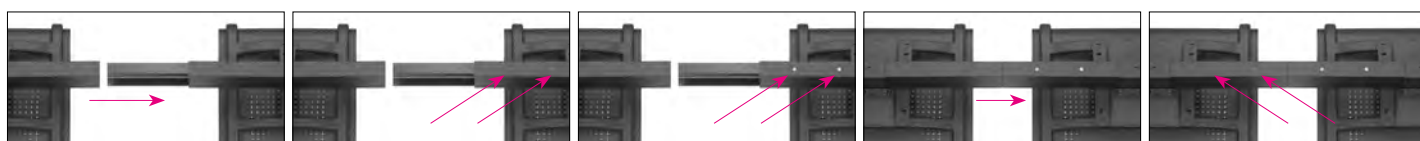

01

02

03

04

05

components / cut & slim options



designed by:
Alessandro Crosera

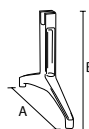

19 cut-pied en aluminium pour banquette + 2 pieds
cut-pata de aluminio para bancada + n.º 2 pies

code	finishing	q.kit	q.pack	a	b	kg.x1	vol.x1
111704-224	○ aluminium/aluminio	x2	5	615	350	2,75	mc. 0,0132

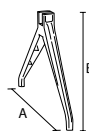

20 slim-pied en aluminium pour banquette + 2 pieds
slim-pata de aluminio para bancada + n.º 2 pies

code	finishing	q.kit	q.pack	a	b	kg.x1	vol.x1
111704-226	○ aluminium/aluminio	x2	5	610	350	1,3125	mc. 0,0102



21 cut-accoudoir en aluminium pour banquette + 2 vis
cut-brazo de aluminio para bancada + n.º 2 tornillos

code	finishing	q.kit	q.pack	a	b	kg.x1	vol.x1
111704-223	○ aluminium/aluminio	x1	10	300	305	1,6065	mc. 0,0028



22 slim-accoudoir en aluminium pour banquette + 2 vis
slim-brazo de aluminio para bancada + n.º 2 tornillos

code	finishing	q.kit	q.pack	a	b	kg.x1	vol.x1
111704-225	○ aluminium/aluminio	x1	10	325	305	1,464	mc. 0,0049



23 cut/slim-cavalier en aluminium pour pied banquette + 2 vis
cut/slim caballete de aluminio para pata bancada + n.º 2 tornillos

code	finishing	q.kit	q.pack	a	b	kg.x1	vol.x1
111704-222	○ aluminium/aluminio	x2	10	60	95	0,30	mc. 0,0005



24 cut/slim-cavalier en aluminium pour accoudoir banquette
cut/slim caballete de aluminio para accoudoir bancada

code	finishing	q.kit	q.pack	a	b	kg.x1	vol.x1
111704-221	○ aluminium/aluminio	x1	10	58	95	0,38	mc. 0,0005

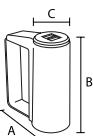

25 e:usb-chargeur pour banquette
e:usb-cargador para bancada

code	finishing	q.kit	q.pack	a	b	c	kg.x1	vol.x1
130703-002	● noir/negro	x1	5	85	100	38	0,28	mc. 0,0009

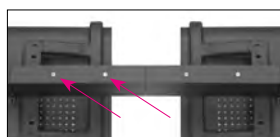

06



07

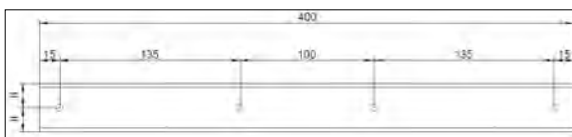

trame de perçage conseillée, côté bas poutre
perforación aconsejada, lado inferior viga

alba 

2 0 2 5
CATALOGUE

art direction & design

seventyseven

photo

photopiù

print

graficasette

alba.

alba.it

Alba is a brand by Metalmeccanica Alba srl

via Boschier, 54/A
31020 San Zenone degli Ezzelini (TV)
info@alba.it
T. +39 0423 969700